

# Snow Park Village

## Transportation Analysis – Transit Priority Alternative

Prepared for:  
Deer Valley

November 2022

UT20-2245

FEHR  PEERS

# Table of Contents

---

<b>1. Executive Summary</b> .....	<b>7</b>
1.1 Study Results .....	8
1.2 LOS Summary.....	9
1.3 Proposed Mitigations.....	11
1.4 Conclusion / Recommendations .....	12
<b>2. Introduction</b> .....	<b>14</b>
2.1 Scope.....	15
2.2 Analysis Methodology .....	18
<b>3. Existing (2020) Background Conditions</b> .....	<b>20</b>
3.1 Roadway System.....	20
3.2 Traffic Volumes .....	21
3.3 Level of Service Analysis .....	24
3.4 Mitigation Measures .....	25
3.5 Origin-Destination Data .....	25
3.6 Vehicle Occupancy Data .....	26
<b>4. Project Conditions</b> .....	<b>30</b>
4.1 Project Description.....	30
4.1.1 Site Access and Circulation .....	30
4.2 Trip Generation .....	33
4.3 Trip Distribution and Assignment.....	38
<b>5. Existing 2020 plus Project Conditions</b> .....	<b>40</b>
5.1 Traffic Volumes .....	40
5.2 Level of Service Analysis .....	42
5.3 Mitigation Measures .....	43
<b>6. Opening Year (2024) Background Conditions</b> .....	<b>47</b>
6.1 Traffic Volumes .....	47
6.2 Level of Service Analysis .....	47
6.3 Mitigation Measures .....	49
<b>7. Opening Year (2024) Plus Project Conditions</b> .....	<b>51</b>
7.1 Traffic Volumes .....	51
7.2 Level of Service Analysis .....	51
7.3 Mitigation Measures .....	53
<b>8. Future 2040 Background Conditions</b> .....	<b>57</b>
8.1 Traffic Volumes .....	57

8.2 Level of Service Analysis .....	57
8.3 Mitigation Measures .....	59
<b>9. Future 2040 plus Project Conditions .....</b>	<b>61</b>
9.1 Purpose .....	61
9.2 Traffic Volumes .....	61
9.3 Level of Service Analysis .....	61
9.4 Mitigation Measures .....	63
<b>10. Roadway Analysis.....</b>	<b>67</b>
10.1 Analysis Results .....	67
<b>11. Site Circulation Analysis.....</b>	<b>69</b>
11.1.1 Conditions and Assumptions.....	69
11.1.2 Analysis Results .....	70
<b>12. Parking Analysis .....</b>	<b>79</b>
12.1 Analysis Method .....	79
12.2 Parking Management .....	81
<b>13. Transit Evaluation .....</b>	<b>82</b>
13.1.1 Existing Transit Service .....	82
13.2 Proposed Transit Improvements .....	82
<b>14. Transportation Demand Management .....</b>	<b>84</b>
14.1 TDM Monitoring .....	85
14.2 Regional Considerations .....	85
<b>15. Conclusion/Recommendations .....</b>	<b>86</b>
<b>Appendix.....</b>	<b>87</b>

## List of Figures

---

Figure 1: Project Location .....	16
Figure 2: Study Intersections .....	17
Figure 3: Existing 2020 Background Saturday AM & PM Peak Hour Traffic Conditions .....	23
Figure 4: Deer Valley Origin-Destination AM Incoming – PM Outgoing Trends .....	29
Figure 5: Conceptual Site Plan.....	32
Figure 6: Saturday AM & PM Peak Hour Trip Generation and Distribution .....	39
Figure 7: Existing 2020 plus Project Saturday AM & PM Peak Hour Traffic Conditions.....	41
Figure 8: Proposed Reconfiguration of Deer Valley Drive / Deer Valley Drive East / Deer Valley Drive West Intersection.....	45
Figure 9: Opening Year 2024 Background Saturday AM & PM Peak Hour Traffic Conditions.....	50
Figure 10: Opening Year 2024 plus Project Saturday AM & PM Peak Hour Traffic Conditions.....	56
Figure 11: Future 2040 Background Saturday AM & PM Peak Hour Traffic Conditions.....	60
Figure 12: Future 2040 plus Project Saturday AM & PM Peak Hour Traffic Conditions .....	66
Figure 13: 2040 Site Circulation Analysis Intersection LOS Results .....	73
Figure 14: 2040 Site Circulation Analysis Intersection Queue Results.....	78



## List of Tables

---

Table 1: Snow Park Village Saturday AM and PM Peak Hour Level of Service Summary .....	10
Table 2: Proposed Mitigations for Snow Park Village-Generated Traffic Impacts.....	11
Table 3: Level of Service Descriptions .....	19
Table 4: Existing 2020 Background Conditions Saturday AM & PM Peak Hour Level of Service.....	24
Table 5: Snow Park Village Vehicle Occupancy Summary.....	28
Table 6: Snow Park Village Trip Generation .....	37
Table 7: Existing 2020 plus Project Conditions Saturday AM & PM Peak Hour Level of Service .....	42
Table 8: Existing 2020 plus Project Mitigated Conditions Saturday AM & PM Peak Hour Level of Service .....	46
Table 9: Opening Year 2024 Background Conditions Saturday AM & PM Peak Hour Level of Service .....	48
Table 10: Opening Year 2024 plus Project Conditions Saturday AM & PM Peak Hour Level of Service .....	52
Table 11: Opening Year 2024 plus Project Mitigated Conditions Saturday AM & PM Peak Hour Level of Service .....	55
Table 12: Future 2040 Background Conditions Saturday AM & PM Peak Hour Level of Service .....	58
Table 13: Future 2040 plus Project Conditions Saturday AM & PM Peak Hour Level of Service.....	62
Table 14: Future 2040 plus Project Mitigated Conditions Saturday AM & PM Peak Hour Level of Service .....	65
Table 15: Roadway Level of Service Peak Hour Two-Way Traffic Thresholds .....	67
Table 16: Snow Park Village Roadway LOS Analysis Summary .....	68
Table 17: Future 2040 Plus Project Conditions Saturday AM & PM Peak Hour Level of Service Site Circulation Results .....	71
Table 19: Future 2040 Plus Project Conditions Saturday AM & PM Peak Hour Queues Site Circulation Analysis .....	75
Table 20: Snow Park Village Parking Analysis Summary .....	80
Table 21: Deer Valley TDM Measures .....	84

*This page intentionally left blank.*

# 1. Executive Summary

This Traffic Impact Study includes the results of a comprehensive traffic operations analysis for the Snow Park Village project at Deer Valley Resort in Park City, Utah. Snow Park Village is a mixed-use development that will serve as an updated base area village for Deer Valley, and includes hotel, residential, commercial, and event center uses. This report includes the full buildout of the Snow Park base that includes the parking and development both north and south of Doe Pass Road.

The scope of this study analyzes the traffic operations and impacts under the following scenarios:

- Existing (2020) Conditions
- Existing (2020) Plus Project Conditions
- Opening Year (2024) Background Conditions
- Opening Year (2024) Plus Project Conditions
- Future (2040) Background Conditions
- Future (2040) Plus Project Conditions

Existing conditions were based on the traffic counts, which were collected originally in 2020. As this process has continued, Park City Staff have accepted that 2020 counts continue to serve as the foundation for this report with adjustments made for assumed marginal increases in traffic on an annual basis. Traffic operations for these scenarios were analyzed at nine study intersections:

1. Doe Pass Road / Deer Valley Drive East
2. Doe Pass Road / Deer Valley Drive West
3. Deer Valley Drive East / Queen Esther Drive
4. Deer Valley Drive East / Solamere Drive
5. Deer Valley Drive / Deer Valley Drive East / Deer Valley Drive West
6. Deer Valley Drive / Marsac Avenue
7. Deer Valley Drive / Bonanza Drive
8. Deer Valley Drive / Park Avenue / Empire Avenue
9. Bonanza Drive / Monitor Drive / SR-248

This study presents analysis results from what is referred to as the *Transit Priority Alternative*, one of two alternatives for area traffic circulation and multimodal facilities along the Deer Valley Drive loop. Analysis results from the other alternative under consideration, the *Bike Priority Alternative*, are presented in a second, parallel report.

This circulation plan includes a seasonal one-way transit lane inbound from the “Y” intersection along Deer Valley Drive West, turn onto Doe Pass Road, and directly access the proposed mobility hub. Outbound

transit traffic will have a flex transit lane that has transit priority at the mobility hub, then parallels general purpose traffic around the loop to the “Y” intersection, at which point transit traffic would merge with general traffic, generally operating in a counterclockwise direction. After ski season during the summer months, the transit lane will be open to bicycle traffic. Management, maintenance, and enforcement will be a City responsibility.

Study intersections 5 and 8 currently operate at Levels of Service (LOS) that do not meet Part City standards, which is LOS C. However, these intersections were analyzed as part of this study to identify Deer Valley’s contributions to traffic at key intersections within Park City in support of Park City Municipal Corporation’s (PCMC) goals of reducing peak-hour traffic volumes by 20% citywide.

The Plus Project traffic operations analyses include trips generated by the Snow Park Village project. The parking analysis accounts for both physical (structured) and behavioral impacts of the identified resort uses, as well as parking pricing. To present conservative, and thereby overestimated, results in this report, reductions in trip generation and parking demand stemming from proposed enhancements to local transit service, operated by Park City Transit and/or High Valley Transit, or Deer Valley’s existing Transportation Demand Management (TDM) program are not included.

## 1.1 Study Results

In Plus project Conditions, six of nine study intersections, with recommended mitigations in place, meet the Park City LOS standards. Under existing conditions, the intersection of Deer Valley Drive / Park Avenue / Empire Avenue operates at a LOS of E/F. Given the City’s longstanding position on additional mitigations at this intersection, none are recommended. Deer Valley Drive in this area is also SR-224, and therefore managed by the Utah Department of Transportation (UDOT). This includes intersection operations. The deficiencies at the Deer Valley Drive / Bonanza Drive intersection are caused by the queue spillbacks from the upstream intersection at Deer Valley Drive / Park Avenue / Empire Avenue. Therefore, no mitigations are recommended.

Furthermore, the most impacted intersection under current conditions, the Deer Valley Drive / Deer Valley Drive East / Deer Valley Drive West intersection, which operates today at a LOS below Park City standards, achieves a LOS of C or better under 2040 Plus Project conditions by reconfiguring the intersection and adding signalized traffic control, establishing a new access pattern for visitors while providing safety for pedestrians and bicyclists. Solamere Drive / Deer Valley Drive East intersection is shown to operate at a LOS D with full build-out in 2040. It can be mitigated to result in a LOS A with a traffic signal. A full signal warrant study will be conducted upon full buildout of the project. The intersection of Queen Esther functions at a LOS C.



Parking provided as part of the Snow Park Village Proposal will be provided at levels roughly 20% lower than required by code. Reduced parking demand will be achieved through the implementation of a paid parking system, and continued operation and refinement of Deer Valley's Transportation Demand Management program by supporting non-single-occupancy vehicle trips while also actively discouraging driving alone, and through time-of-day sharing of parking for different and complementary uses.

In alignment with Park City's *Transit First* strategy, construction of Snow Park Village will prioritize active transportation and transit as modes for travel to, from, and within the village. To that end, Deer Valley will construct an on-site mobility hub with space for six buses which will be connected to the broader Park City and High Valley Transit networks. One new traffic signal is recommended, at the intersection of Doe Pass Road / Deer Valley Drive East as a mitigation which will include transit signal preemption capabilities to expedite transit service into and out of proposed the mobility hub. Additionally, off-street multi-use paths will be constructed to connect Snow Park to Park City's existing active transportation network.

## 1.2 LOS Summary

**Table 1** reports LOS at the study intersections. For signalized intersections and roundabouts, average vehicular delay and LOS are reported. For unsignalized intersections, the worst movement delay and LOS are reported. Detailed descriptions of the intersection operations can be found in the subsequent chapters. Due to the land use program proposed for Snow Park Village, the net total trips generated by the AM peak hour is 162 trips and the PM peak hour is 204 trips.

**Table 1: Snow Park Village Saturday AM and PM Peak Hour Level of Service Summary**

Intersection			Ex BG	Ex+P	Ex+P Mitigated <sup>2</sup>	2024 BG	2024+P	2024+P Mitigated <sup>2</sup>	2040 BG	2040+P	2040+P Mitigated <sup>2</sup>
ID	Location	Period	LOS & Sec/Veh <sup>1</sup>	LOS & Sec/Veh <sup>1</sup>	LOS & Sec/Veh <sup>1</sup>	LOS & Sec/Veh <sup>1</sup>	LOS & Sec/Veh <sup>1</sup>	LOS & Sec/Veh <sup>1</sup>	LOS & Sec/Veh <sup>1</sup>	LOS & Sec/Veh <sup>1</sup>	LOS & Sec/Veh <sup>1</sup>
1	Doe Pass Rd / Deer Valley Dr East	AM	-	2 / A	15 / B	-	2 / A	16 / B	-	2 / A	4 / A
		PM	-	2 / A	5 / A	-	2 / A	5 / A	-	2 / A	7 / A
2	Doe Pass Rd / Deer Valley Dr West	AM	-	10 / B	7 / A	-	10 / B	8 / A	-	10 / B	9 / A
		PM	-	12 / B	5 / A	-	15 / B	7 / A	-	16 / C	6 / A
3	Queen Esther Dr / Deer Valley Dr East	AM	6 / A	7 / A	8 / A	6 / A	7 / A	7 / A	7 / A	7 / A	8 / A
		PM	9 / A	8 / A	15 / C	8 / A	10 / B	16 / C	9 / A	>300 / F	20 / C
4	Deer Valley Dr East / Solamere Dr	AM	7 / A	7 / A	8 / A	6 / A	8 / A	7 / A	8 / A	8 / A	9 / A
		PM	11 / B	13 / B	20 / C	11 / B	12 / B	18 / C	15 / C	>300 / F	32 / D <sup>3</sup>
5	Deer Valley Dr / Deer Valley Dr East / Deer Valley Dr West	AM	15 / C	11 / B	7 / A	14 / B	13 / B	7 / A	17 / C	33 / D	8 / A
		PM	<b>39 / E</b>	<b>164 / F</b>	17 / B	<b>41 / E</b>	<b>74 / F</b>	16 / B	<b>112 / F</b>	<b>135 / F</b>	27 / C
6	Deer Valley Drive / Marsac Avenue	AM	11 / B	12 / B	12 / B	11 / B	13 / B	13 / B	16 / C	20 / C	20 / C
		PM	11 / B	13 / B	13 / B	11 / B	14 / B	14 / B	11 / B	11 / B	11 / B
7	Deer Valley Dr / Bonanza Dr	AM	11 / B	11 / B	11 / B	11 / B	12 / B	12 / B	18 / B	15 / B	23 / C
		PM	21 / C	26 / C	24 / C	20 / C	24 / C	24 / C	<b>59 / E</b>	<b>97 / F</b>	<b>67 / E</b>
8	Deer Valley Dr / Park Ave / Empire Ave	AM	<b>77 / E</b>	<b>78 / E</b>	<b>76 / E</b>	<b>82 / F</b>	<b>79 / E</b>	<b>78 / E</b>	<b>83 / F</b>	<b>82 / F</b>	<b>83 / F</b>
		PM	<b>84 / F</b>	<b>86 / F</b>	<b>87 / F</b>	<b>85 / F</b>	<b>88 / F</b>	<b>88 / F</b>	<b>90 / F</b>	<b>90 / F</b>	<b>91 / F</b>
9	Bonanza Dr / Monitor Dr / SR-248	AM	12 / B	12 / B	13 / B	13 / B	13 / B	13 / B	16 / B	17 / B	15 / B
		PM	20 / C	20 / C	20 / C	20 / C	21 / C	23 / C	28 / C	32 / C	31 / C

Notes:

**Bold text** indicates intersections operating below Park City's acceptable LOS threshold.

1. Intersection average LOS and delay for signalized intersections and roundabouts, worst movement LOS and delay for unsignalized intersections.
2. Deer Valley Drive East / Deer Valley Drive West intersection analyzed as a reconfigured signalized intersection, and turn lanes/receiving lanes added to Solamere Drive and Queen Esther Drive intersections as a mitigation.
3. Solamere Drive performs at LOS D as a SSSC. Further analysis shows this intersection operates at LOS A as a signalized intersection, when warranted.

Source: Fehr & Peers.

## 1.3 Proposed Mitigations

The traffic operations analyses conducted as part of the report indicate that five study intersections will operate at unacceptable LOS in comparison with Park City’s standards under 2040 plus project conditions without mitigations. Community input gathered through stakeholder engagement resulted in the community-supported mitigations for identified deficiencies stemming from Snow Park Village-generated traffic shown in **Table 2**.

**Table 2: Proposed Mitigations for Snow Park Village-Generated Traffic Impacts**

ID	Location	Control	Deficiency <sup>1</sup>	Proposed Mitigations
1	Doe Pass Rd / Deer Valley Dr East	SSSC <sup>2</sup>	N/A	Signal with transit preemption
2	Doe Pass Rd / Deer Valley Dr West	SSSC	N/A	N/A
3	Queen Esther Dr / Deer Valley Dr East	SSSC	LOS F	Southbound-to-eastbound left turn-pocket
4	Deer Valley Dr East / Solamere Dr	SSSC	LOS F	Eastbound-to-northbound left turn-pocket
5	Deer Valley Dr / Deer Valley Dr East / Deer Valley Dr West	SSSC	LOS F	Signal
6	Deer Valley Drive / Marsac Avenue	Roundabout	N/A	N/A
7	Deer Valley Dr / Bonanza Dr	Signal	LOS F	N/A
8	Deer Valley Dr / Park Ave / Empire Ave	Signal	LOS F	N/A
9	Bonanza Dr / Monitor Dr / SR-248	Signal	N/A	N/A

Notes:

1. LOS for 2040 plus project without mitigations.
2. SSSC = Side Street Stop Control

Source: Fehr & Peers, 2022

## 1.4 Conclusion / Recommendations

With proposed mitigations in place, all study intersections with one exception (LOS D at Solamere) at which mitigations are feasible operate at acceptable levels of service under all Plus Project analysis scenarios. Through dedicated transit infrastructure, improved active transportation connections between the Project and Park City's existing active transportation network, a fully reworked parking system, extensive wayfinding and monitoring, and management of ongoing TDM offerings in addition to new measures, the Snow Park Village proposal aligns with the City's *Transit First* policy by encouraging travel by means other than driving alone.

Implementing a new traffic signal with transit preemption at the intersection of Doe Pass Road / Deer Valley Drive East will improve traffic operations and support transit. A new traffic signal at the reconfigured Y intersection of Deer Valley Drive / Deer Valley Drive East / Deer Valley Drive west facilitates safer and more efficient movement for all modes. If, and when signal warrants at study unsignalized intersections in this report are met (Solamere), as defined by the Federal Highway Administration's *Manual on Uniform Traffic Control Devices*, the implementation of new traffic signals should be considered for improved traffic circulation for all modes. Deer Valley is committed to being a partner of the subsequent studies, and if warranted, implementation.

Implementing an off-street, multi-use path around the Deer Valley Drive loop will improve pedestrian and cyclist connectivity adjacent to the project site. Ongoing monitoring of TDM program effectiveness will maintain City-Deer Valley cooperation in pursuit of shared goals.

The traffic volumes used for this overall analysis are conservative and likely represent worst case on the worst day. For example, the assumed background growth rate is from a county-wide travel model that assumes some degree of ambient growth in and around Deer Valley beyond the proposed Snow Park project. Given that the Deer Valley loop area is essentially one big cul-de-sac and generally built out, this background growth is quite conservative.

Other measures that support the conservative nature of the analysis is the Mayflower development interconnecting with Deer Valley. An agreement is under development that will provide parking, lift access and full base amenities to skiers going to Deer Valley at Mayflower base, along US-40. This potential agreement will also provide for employee parking with a shuttle program between Mayflower and Snow Park. The analysis does not account for any trip reductions to Snow Park, which will inevitably occur due to significant travel time reductions from both the Wasatch Front and the Heber Valley.

Last, Deer Valley is committed to supporting other regional traffic mitigation efforts. This includes considerations such as contributing to transit, and robust travel demand reduction program, and paid





parking at Snow Park once the project is built. The proposed transit amenities include the mobility hub, a dedicated transit flex lane, state-of-the-art wayfinding, and a monitoring program all combine to support the City's transportation goals.

## 2. Introduction

This study documents the potential transportation-related impacts on local traffic from the proposed Snow Park Village project. The project location is shown in **Figure 1**.

This report is largely unchanged from what was presented in the most recent submittal (July 2022), save for some minor but impactful updates:

1. Assumed distributions of arrival and departure traffic have been modified slightly to better reflect assumed operations and more closely mirror existing traffic patterns
2. The geometry and traffic control of the Deer Valley Drive / Deer Valley Drive East / Deer Valley Drive West intersection has been refined following multiple rounds of third-party review
3. The geometry at Solamere Drive / Deer Valley Drive East and Queen Esther Drive / Deer Valley Drive East intersections have been refined to address access concerns from the third-party reviewer.

The scope of this study analyzes the traffic operations and impacts under the following scenarios:

- Existing (2020) Conditions
- Existing (2020) Plus Project Conditions
- Opening Year (2024) Background Conditions
- Opening Year (2024) Plus Project Conditions
- Future (2040) Background Conditions
- Future (2040) Plus Project Conditions

Traffic operations at key intersections, described below in the Scope section, were analyzed under the six scenarios listed above during Saturday AM and PM peak-hour travel periods. Given the nature of ski areas operating as recreational destinations, Saturdays consistently experience the highest traffic volumes, and focusing on Saturdays for traffic analyses in this report present the most conservative results. The Plus Project analyses include trips generated by the proposed project.

The project team knows that it is important to work with the community to help them better understand the complexity of building out the remaining entitled density at Snow Park and its relation to traffic, and ensuring that the Deer Valley community can contribute to the planning process. Throughout the project's planning process, and with renewed emphasis since the beginning of 2022, Deer Valley has engaged with most of the lower Deer Valley neighborhoods and that communication continues today. Early outreach was done with the Trails End neighborhood in relation to the right of way vacation to gain their support. After the community voiced their opinion in March 2022, the project team opted to hold individual meetings with various homeowner's associations (HOAs) to address concerns and gather

feedback. The community’s main concerns were the then-proposed bus-only lanes, removal of on-street bike paths, the proposed routing of most traffic on Deer Valley Drive East, construction of new traffic signals, and pedestrian circulation. Coordination meetings with the community continued with nearly one dozen meetings in summer and fall 2022, with more scheduled. This revised traffic circulation plan as submitted is based on the community’s input and support, augmented by City staff requests.

## 2.1 Scope

This study analyzes the traffic impacts of the project in conjunction with nearby intersections. Impacts are specifically addressed at the following study intersections:

1. Doe Pass Road / Deer Valley Drive East (side-street stop-controlled)
2. Doe Pass Road / Deer Valley Drive West (side-street stop-controlled)
3. Deer Valley Drive East / Queen Esther Drive (side-street stop-controlled)
4. Deer Valley Drive East / Solamere Drive (side-street stop-controlled)
5. Deer Valley Drive / Deer Valley Drive East / Deer Valley Drive West (side-street stop-controlled)
6. Deer Valley Drive / Marsac Avenue (roundabout)
7. Deer Valley Drive / Bonanza Drive (signalized)
8. Deer Valley Drive / Park Avenue / Empire Avenue (signalized)
9. Bonanza Drive / Monitor Drive / SR-248 (signalized)

For the purposes of consistency, this report refers to two key roadways as Deer Valley Drive East (sometimes called Deer Valley Drive North) and Deer Valley Drive West (sometimes called Deer Valley Drive South). Given that Doe Pass Road carries minimal traffic in its existing configuration, study intersections 1 and 2 are only analyzed under Plus Project scenarios.

Study intersections are shown in **Figure 2**.



Figure 1  
Project Location 



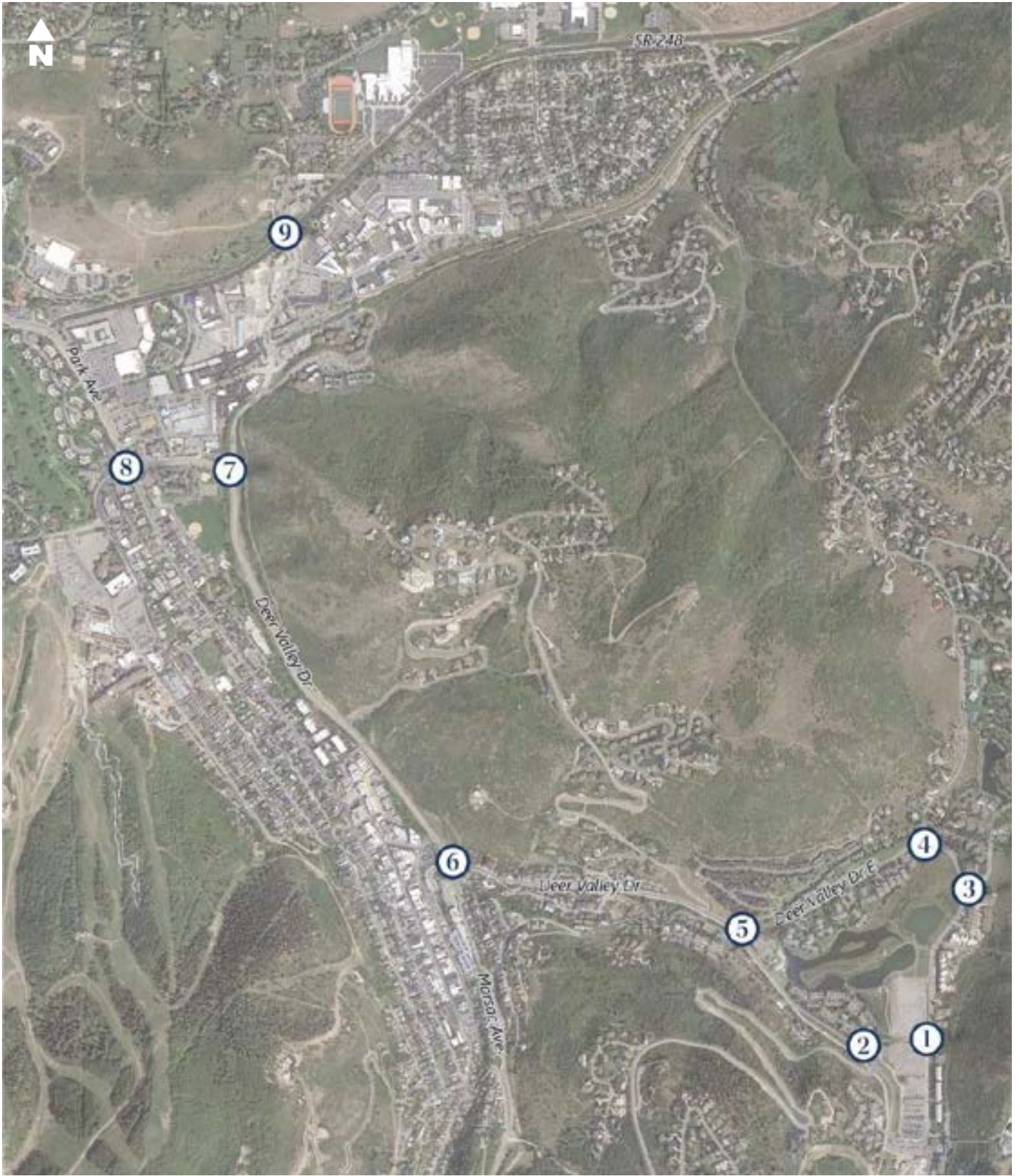

Figure 2  
Study Intersections 

## 2.2 Analysis Methodology

“Level of service” (LOS) is a term that describes the operating performance of an intersection or roadway. LOS is measured quantitatively and reported on a scale from A to F, with A representing the best performance and F the worst. **Table 3** provides a brief description of each LOS letter designation and an accompanying average delay per vehicle for both signalized and unsignalized intersections. Traffic operations were modeled in SimTraffic, a microsimulation traffic analysis software. SimTraffic results were evaluated under the Highway Capacity Manual 6<sup>th</sup> Edition (HCM 2016) methodology in this study to remain consistent with “state of the practice” professional standards, and with earlier iterations of this report. Since this study began, a new edition of the Highway Capacity Manual has been published, though application to analyses conducted as part of this study would not change results. For study intersection 4, Deer Valley Drive / Marsac Avenue, the SIDRA analysis software was used as it is accepted as state-of-the-practice for roundabout operations analysis. For signalized intersections and roundabouts, the LOS is provided for the overall intersection (weighted average of all approach delays). Park City Municipal Corporation has an established threshold of acceptable traffic operations as LOS of C for all intersections under its control.

**Table 3: Level of Service Descriptions**

LOS	Description	Signalized Intersections	Unsignalized Intersections	Roundabouts
		Avg. Delay (sec/veh) <sup>1</sup>	Avg. Delay (sec/veh) <sup>2</sup>	Avg. Delay (sec/veh) <sup>3</sup>
A	<i>Free Flow / Insignificant Delay</i> Extremely favorable progression. Individual users are virtually unaffected by others in the traffic stream.	< 10.0	< 10.0	< 10.0
B	<i>Stable Operations / Minimum Delays</i> Good progression. The presence of other users in the traffic stream becomes noticeable.	> 10.0 to 20.0	> 10.0 to 15.0	> 10.0 to 15.0
C	<i>Stable Operations / Acceptable Delays</i> Fair progression. The operation of individual users is affected by interactions with others in the traffic stream	> 20.0 to 35.0	> 15.0 to 25.0	> 15.0 to 25.0
D	<i>Approaching Unstable Flows / Tolerable Delays</i> Marginal progression. Operating conditions are noticeably more constrained.	> 35.0 to 55.0	> 25.0 to 35.0	> 25.0 to 35.0
E	<i>Unstable Operations / Significant Delays Can Occur</i> Poor progression. Operating conditions are at or near capacity.	> 55.0 to 80.0	> 35.0 to 50.0	> 35.0 to 50.0
F	<i>Forced, Unpredictable Flows / Excessive Delays</i> Unacceptable progression with forced or breakdown of operating conditions.	> 80.0	> 50.0	> 50.0

1. Overall intersection LOS and average delay (seconds/vehicle) for all approaches.
  2. Worst approach LOS and delay (seconds/vehicle) only.
  3. Overall intersection LOS and average delay (seconds/vehicle) for all approaches.
- Source: Fehr & Peers descriptions, based on *Highway Capacity Manual, 6<sup>th</sup> Edition*.

## 3. Existing (2020) Background Conditions

The Existing (2020) Background Conditions analysis examines the study intersections and roadways during the AM and PM peak-hours existing traffic and geometric conditions. The existing conditions analyses were performed using traffic data collected in 2020. Subsequent rounds of analysis have used adjusted counts to assume marginal increases in traffic, with growth factors taken from a regional travel model. Through this analysis, existing traffic operational deficiencies can be identified, and potential mitigation measures recommended.

### 3.1 Roadway System

The primary roadways that will provide access to the project, and their existing configurations, are described below.

- **Deer Valley Drive (SR-224)** is a state-owned and managed facility and is classified as a principal arterial road and has a posted speed limit of 35 mph from Park Avenue to about halfway between Bonanza Drive and Marsac Avenue, and 40 mph to the Marsac Avenue roundabout. SR-224 has a five-lane cross section with two travel lanes in each direction with a two-way left-turn lane north of the Marsac Avenue roundabout.
- **Marsac Avenue (SR-224)** is also a state-owned facility and is classified as a principal arterial road and has a posted speed limit of 25 mph. Marsac Avenue has a two-lane cross section with one travel lane in each direction near the project area.
- **Deer Valley Drive West** is classified as a major collector road and has a posted speed limit of 25 mph. Deer Valley Drive West has a two-lane cross section with one travel lane in each direction near the project area.
- **Deer Valley Drive East** this loop section of Deer Valley Drive is classified as a collector road and has a posted speed limit of 25 mph. Deer Valley Drive East has a two-lane cross section with one travel lane in each direction near the project area.
- **Queen Esther Drive** is classified as a collector road and has a posted speed limit of 25 mph. Queen Esther Drive has a two-lane cross section with one unstriped travel lane in each direction near the project area.
- **Solamere Drive** is classified as a collector road and has a posted speed limit of 25 mph. Solamere Drive has a two-lane cross section, with one travel lane in each direction and a landscaped median near the project area.



- **Doe Pass Road** is classified as a collector road and has a posted speed limit of 25 mph. Doe Pass Road has a two-lane cross section with one unstriped travel lane in each direction near the project area.

## 3.2 Traffic Volumes

Intersection turning movement counts were collected at the following study intersections to establish a baseline of existing conditions and operations for this study's original scope of work:

- Deer Valley Drive / Deer Valley Drive East / Deer Valley Drive West
- Deer Valley Drive / Marsac Avenue
- Deer Valley Drive / Bonanza Drive

Intersection turning movement counts were collected at the Deer Valley Drive / Deer Valley Drive East / Deer Valley Drive West intersection on Saturday, February 15, 2020 (President's Day weekend) and Saturday, February 29, 2020 for the Saturday AM peak period (7:45 AM – 9:45 AM) and the Saturday PM peak period (3:30 PM – 5:30 PM). Counts collected on February 29, 2020 showed higher peak-hour traffic volumes, and were therefore used as existing traffic volumes for the analysis presented in this study. While it is highly unusual to analyze operations during absolute peak conditions, due to the risk of over-building infrastructure and exaggerating typical issues, this was the request of the City.

Intersection turning movement counts were collected at the Deer Valley Drive / Marsac Avenue roundabout and the Bonanza Drive / Deer Valley Drive intersection on December 19, 2020 for the Saturday AM and PM peak periods.

The original, City-approved scope for this study included study intersections 5, 6, and 7. As a result of requests from the City and their reviewers for expanded traffic operations analysis beyond that included in the original study. As a result, counts were sourced from other, existing work and adjusted to present conservative results.

Roadway vehicle counts are provided by the Utah Department of Transportation (UDOT) Continuous Count Stations (CCS). Data from the past five years as collected at two CCSs in the vicinity of the project site (one on SR-224 just south of Kimball Junction and one on SR-248 just west of Quinn's Junction) were reviewed to determine when during the ski season peak traffic volumes occur. It was observed from the data that the month of January experienced the highest Average Daily Traffic (ADT) volumes of any month of the year. This is likely due to increases in traffic caused by events in the area including the Sundance Film Festival. While January is likely the busiest month for traffic on the outskirts of Park City, traffic volumes in February are nearly as high, and Presidents' Day Weekend is among the busiest weekend of the year for skier traffic.

To account for this, the intersection volumes collected in December were adjusted by a factor of 1.05 (5% higher) to replicate February conditions.

For study intersections 8 and 9, which were not included in this study's original scope, intersection counts were sourced from previous studies with adjustment factors. For the intersection of Deer Valley Drive / Park Avenue / Empire Avenue, counts were sourced from the *Park City Mountain Resort Traffic Impact Study* (August, 2019). Counts for this study were collected on February 18, 2017 and were adjusted by a factor of 1.14 (14% higher) to account for a peak winter day, as described in the August 2019 study. These adjusted counts were used for this study. For the intersection of Bonanza Drive / Monitor Drive / SR-248, no Saturday counts were available. To overcome this challenge, weekday counts collected on February 6, 2018 as part of the *Park City Arts District Traffic Analysis* (September 2019) were used as a foundation. Through reviewing two years of CCS data, weekday-to-weekend adjustment factors of 0.63 (37% lower) for the AM peak hour, and 0.85 (15% lower) for the PM peak hour were applied for this study.

To address comments from City Staff and community members, turning movement counts were collected at study intersections 3 and 4 to better understand how project-generated traffic might affect local intersections not included in the original study scope. The turning movement counts were collected on Thursday-Saturday, March 3-5, 2022, for the AM and PM peak periods. The highest turning movement counts among the three days at each location were used for conservative results.

Given that they were not included in the original scope of this study, and the substantial changes proposed along Doe Pass Road, no counts for the intersections of Deer Valley Drive East / Doe Pass Road and Deer Valley Drive West / Doe Pass Road were available, and these intersections were only evaluated in the Plus Project conditions.

The existing 2020 background Saturday AM and PM peak hour volumes are shown in **Figure 3**.

Fehr & Peers also collected Saturday daily roadway counts on February 15, 2020 (President's Day weekend) on the internal Deer Valley Drive roadways at the following locations:

- Deer Valley Drive West – between Royal Street and drop-off/pick-up area
- Deer Valley Drive West – south of the Deer Valley Drive East / Deer Valley Drive West intersection
- Deer Valley Drive East – between Queen Esther Drive and parking lot
- Deer Valley Drive East – east of the Deer Valley Drive East / Deer Valley Drive West intersection

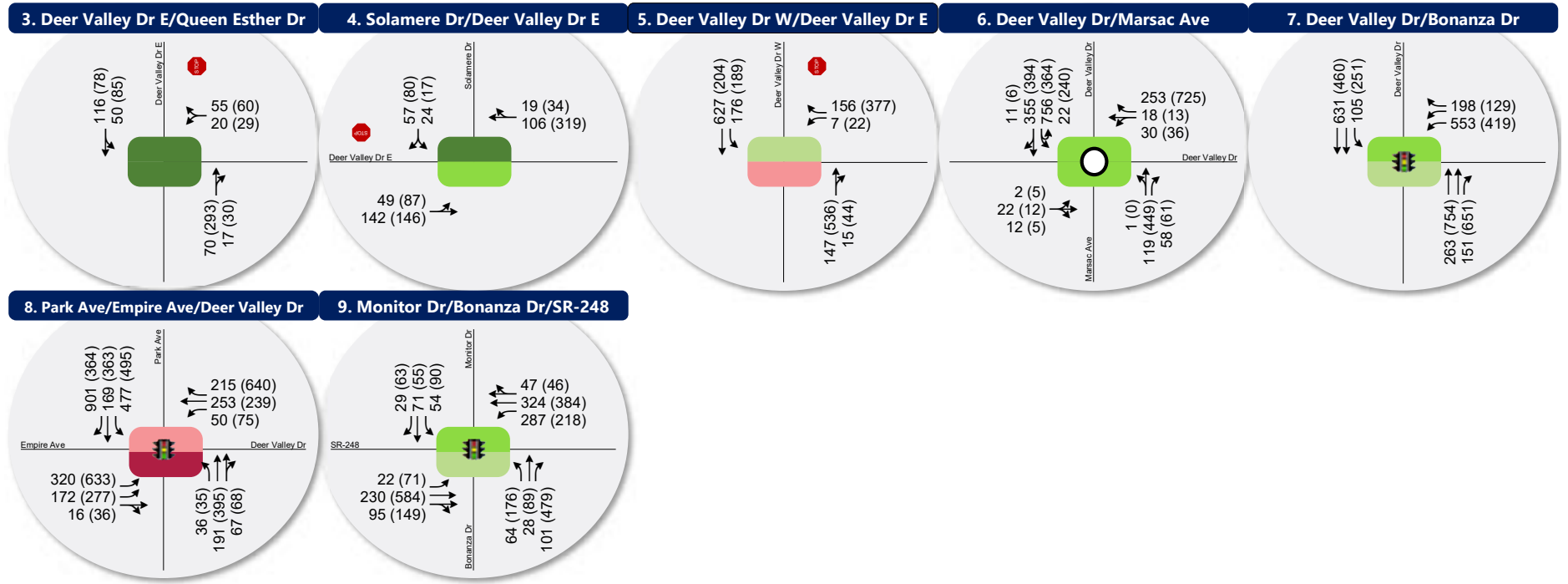

**LEGEND**

Stop Sign    
 Signalized    
 Roundabout

Lane Configuration:
 

- ← AM (PM)
- ← AM (PM)
- ← AM (PM)

 Peak Hour Traffic Volume per lane

Intersection Level of Service (LOS):

**A**    
 **B**    
 **C**    
 **D**    
 **E**    
 **F**

Existing 2020 Background Saturday AM & PM Peak Hour Traffic Conditions 

Figure 3

## 3.3 Level of Service Analysis

Using SimTraffic simulation software (for signalized and unsignalized intersections) and SIDRA software (for the roundabout) and the HCM 6 delay thresholds provided in the Introduction, the existing background Saturday AM and PM peak hour LOS were computed for each study intersection. The results of this analysis for the Saturday AM and PM peak hours are reported in **Table 4** (see Appendix for the detailed LOS report). These results serve as a base for the analysis of the impacts of the proposed Snow Park Village development.

**Table 4: Existing 2020 Background Conditions Saturday AM & PM Peak Hour Level of Service**

Intersection				Worst Movement <sup>1</sup>			Overall Intersection <sup>2</sup>	
ID	Location	Period	Control	Movement <sup>3</sup>	Delay Sec/Veh	LOS	Avg. Delay Sec/Veh	LOS
1	Doe Pass Rd / Deer Valley Dr East	AM	SSSC <sup>4</sup>	-	-	-	-	-
		PM		-	-	-	-	-
2	Doe Pass Rd / Deer Valley Dr West	AM	SSSC	-	-	-	-	-
		PM		-	-	-	-	-
3	Queen Esther Dr / Deer Valley Dr East	AM	SSSC	WB Left	6	A	-	-
		PM		WB Left	9	A	-	-
4	Deer Valley Dr East / Solamere Dr	AM	SSSC	SB Left	7	A	-	-
		PM		SB Left	11	B	-	-
5	Deer Valley Dr / Deer Valley Dr East / Deer Valley Dr West	AM	SSSC	WB Left	15	C	-	-
		PM		WB Left	<b>39</b>	<b>E</b>	-	-
6	Deer Valley Drive / Marsac Avenue	AM	Roundabout	-	-	-	11	B
		PM		-	-	-	11	B
7	Deer Valley Dr / Bonanza Dr	AM	Signal	-	-	-	11	B
		PM		-	-	-	21	C
8	Deer Valley Dr / Park Ave / Empire Ave	AM	Signal	-	-	-	<b>77</b>	<b>E</b>
		PM		-	-	-	<b>84</b>	<b>F</b>
9	Bonanza Dr / Monitor Dr / SR-248	AM	Signal	-	-	-	12	B
		PM		-	-	-	20	C

Notes:

**Bold text** indicates intersections operating below Park City's acceptable LOS threshold.

1. This represents the worst approach LOS and delay (seconds/vehicle) and is only reported for unsignalized intersections.
2. This represents the overall intersection LOS and delay (seconds/vehicle) and is only reported for signalized intersections and roundabouts.
3. NB=Northbound, SB=Southbound, EB=Eastbound, WB=Westbound
4. Side-street stop control.

Source: Fehr & Peers.



As shown in **Table 4**, all study intersections operated within acceptable LOS (LOS C or better), with the exception of the following locations:

- Deer Valley Drive East / Deer Valley Drive West: LOS E in the PM peak hour
  - This is caused by the high volumes of vehicles exiting the Deer Valley Resort area making a westbound right turn onto Deer Valley Drive West. The westbound approach is stop-controlled, making it difficult for vehicles to find a gap and turn onto Deer Valley Drive West.
- Deer Valley Drive / Park Avenue / Empire Avenue: LOS E in the AM peak hour, LOS F in the PM peak hour
  - This is caused by congestion at the signal due to high volumes accessing various ski resorts and downtown Park City.

It should be noted that while the Bonanza Drive / Deer Valley Drive intersection operates within acceptable LOS, it is often impacted by vehicle queues spilling back to this intersection from the upstream intersection at Deer Valley Drive / Park Avenue / Empire Avenue in the PM peak hour.

## 3.4 Mitigation Measures

The concept master plan for Snow Park Village shows reconfiguration and signalization of the Deer Valley Drive / Deer Valley Drive East / Deer Valley Drive West intersection, which will alter the westbound LOS at this intersection. Therefore, Fehr & Peers does not recommend any mitigation measures for existing background conditions.

## 3.5 Origin-Destination Data

To understand the distribution of origins from which travelers access Deer Valley, Fehr & Peers employed origin-destination data provided by StreetLight Data. StreetLight Data collects samples of trips using anonymized mobile phone data (location-based services, or LBS) and aggregates it to provide estimates of travel between origin-destination pairs. In this study, trips to and from surrounding areas (Kamas-Richardson, Kimball-Jeremy, Midway-Heber, North Summit County, Wasatch Front, and Park City Old Town/Mountain Resort) were examined. The data sample used in this study was based on 2019 and 2020 observed travel patterns on weekend days during morning and afternoon peak periods (8:00am-10:00am and 3:00pm-5:00pm, respectively) in January and February (peak ski months). The figure below displays the distributions of origins for visitors of the Deer Valley Resort, as also shown in **Figure 4**.



Traffic to Deer Valley from...  
(AM Peak)

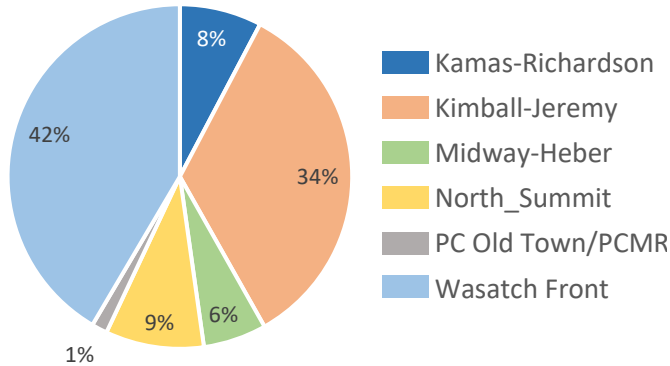

Traffic from Deer Valley to...  
(PM Peak)

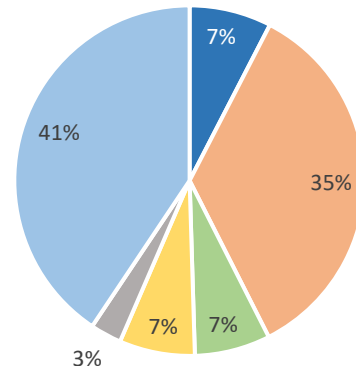

The Wasatch Front contributes the majority of visitors to and from Deer Valley Resort with 42% and 41% in the AM peak and PM peak, respectively. The Kimball-Jeremy area contributes the second-greatest percentage of visitors with 34% and 35% in the AM peak and PM peak, respectively. The vehicular traffic to and from the Kimball-Jeremy area are good candidates to encourage shifting to transit or other modes, especially if improved transit service accessing Deer Valley Resort is provided.

This data represents existing travel patterns and do not account for potential changes in travel following the construction of Snow Park Village; trip distributon and assignment as shown in section 4.4 of this report primarily focuses on new project trips. Furthermore, StreetLight Data can not ditinguish between single-occupancy vehicles and high-occupancy/transit vehicles, and therefor does not account for current carpooling or transit usage.

### 3.6 Vehicle Occupancy Data

In addition to traffic counts and StreetLight Data, Fehr & Peers collected vehicle occupancy counts for AM peak-period, inbound traffic for the Deer Valley Resort. Vehicle occupancy counts were collected for the following three days:

- Saturday, February 13, 2021
- Tuesday, February 23, 2021
- Saturday, February 27, 2021

**Table 5** presents a summary of vehicle occupancy data, calculated from data collected during the three days listed above. It should be noted that the vehicle occupancy counts were collected during the global COVID-19 pandemic, and the data shown in **Table 5** could be skewed because people are less likely to carpool with individuals outside of their immediate home due to risks presented by Covid-19.

In summary, the average vehicle occupancy for Snow Park Village was observed to be 2.02 occupants/vehicle on Saturday (weighted average of the two sample Saturdays), and 1.90 occupants/vehicle on a weekday (from a single weekday). Also, the percent of single-occupant vehicles was observed to be about 36% on Saturday (weighted average of the two sample Saturdays), and about 38% on a weekday (from a single weekday). Vehicle occupancy is a useful metric to have available for baseline conditions, as it can be used in evaluating how future implementation of potential transportation demand management (TDM) strategies and broader transit network improvements could impact travel behavior. It should be noted that, due to the global Covid-19 pandemic, carpooling may be lower than pre-pandemic levels. However, a return to higher rates of carpooling is expected to be achievable in the near future.

**Table 5: Snow Park Village Vehicle Occupancy Summary**

Time Period	Total Vehicle Count	Average Occupancy	Single Occupant Vehicles	Percent Single Occupant Vehicles
<b>Saturday, February 13, 2021</b>				
7:45 – 8:00	45	1.76	19	42%
8:00 – 8:15	58	1.84	23	40%
8:15 – 8:30	59	2.12	17	29%
8:30 – 8:45	68	2.09	19	28%
8:45 – 9:00	74	2.04	26	35%
9:00 – 9:15	26	2.12	12	46%
9:15 – 9:30	22	1.95	10	45%
9:30 – 9:45	20	1.95	7	35%
<b>Sum</b>	<b>372</b>	<b>-</b>	<b>133</b>	<b>-</b>
<b>Weighted Average</b>	<b>-</b>	<b>1.99</b>	<b>-</b>	<b>36%</b>
<b>Tuesday, February 23, 2021</b>				
7:45 – 8:00	15	1.60	6	40%
8:00 – 8:15	32	1.50	22	69%
8:15 – 8:30	48	1.65	24	50%
8:30 – 8:45	56	1.91	17	30%
8:45 – 9:00	63	2.00	23	37%
9:00 – 9:15	48	1.92	16	33%
9:15 – 9:30	43	2.23	11	26%
9:30 – 9:45	24	2.17	5	21%
<b>Sum</b>	<b>329</b>	<b>-</b>	<b>124</b>	<b>-</b>
<b>Weighted Average</b>	<b>-</b>	<b>1.90</b>	<b>-</b>	<b>38%</b>
<b>Saturday, February 27, 2021</b>				
7:45 – 8:00	41	1.66	20	49%
8:00 – 8:15	77	2.04	24	31%
8:15 – 8:30	100	1.91	38	38%
8:30 – 8:45	93	2.11	28	30%
8:45 – 9:00	120	2.28	40	33%
9:00 – 9:15	133	1.98	61	46%
9:15 – 9:30	129	1.97	39	30%
9:30 – 9:45	38	2.13	10	26%
<b>Sum</b>	<b>731</b>	<b>-</b>	<b>260</b>	<b>-</b>
<b>Weighted Average</b>	<b>-</b>	<b>2.03</b>	<b>-</b>	<b>36%</b>

Source: Fehr & Peers.



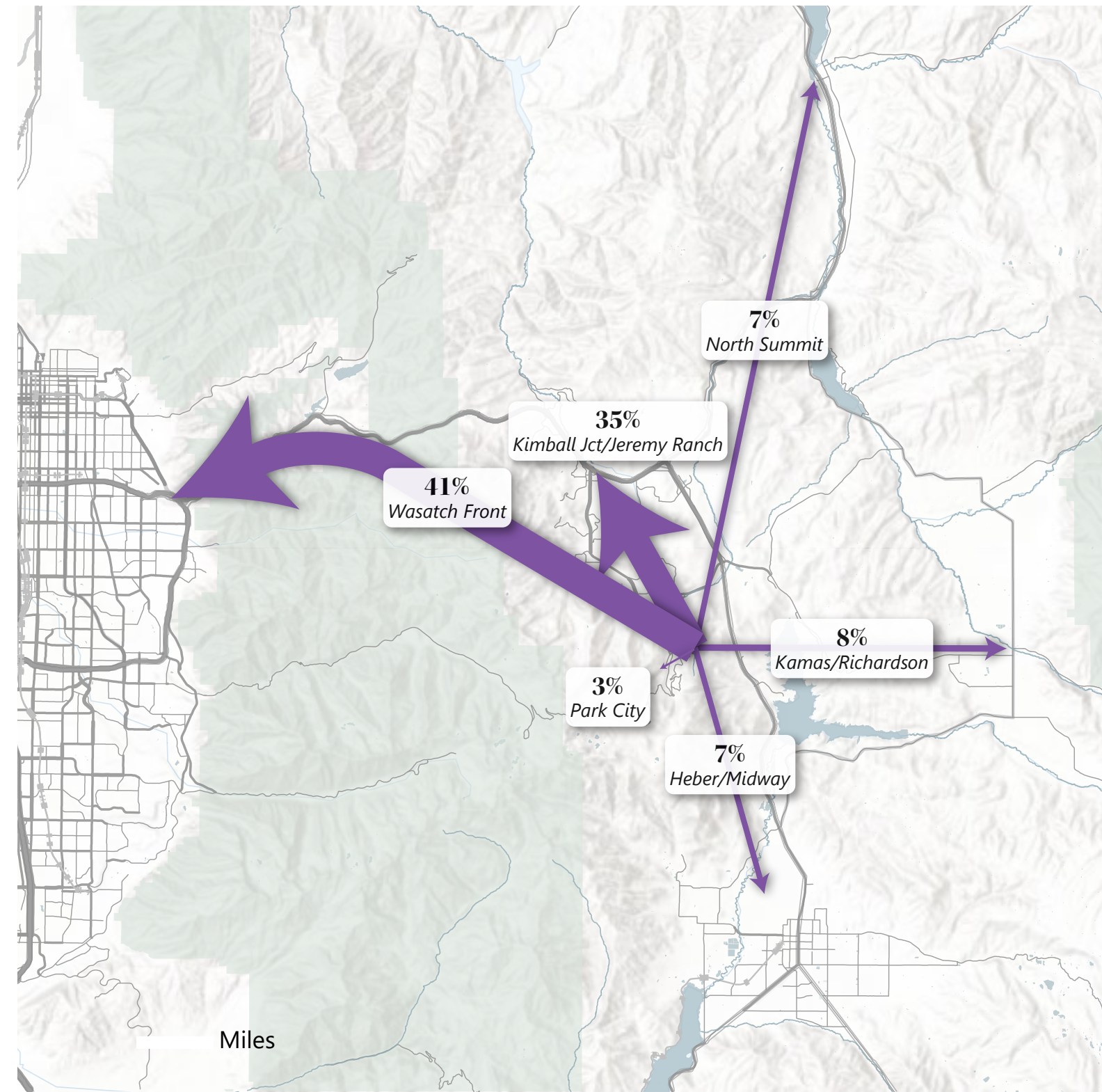
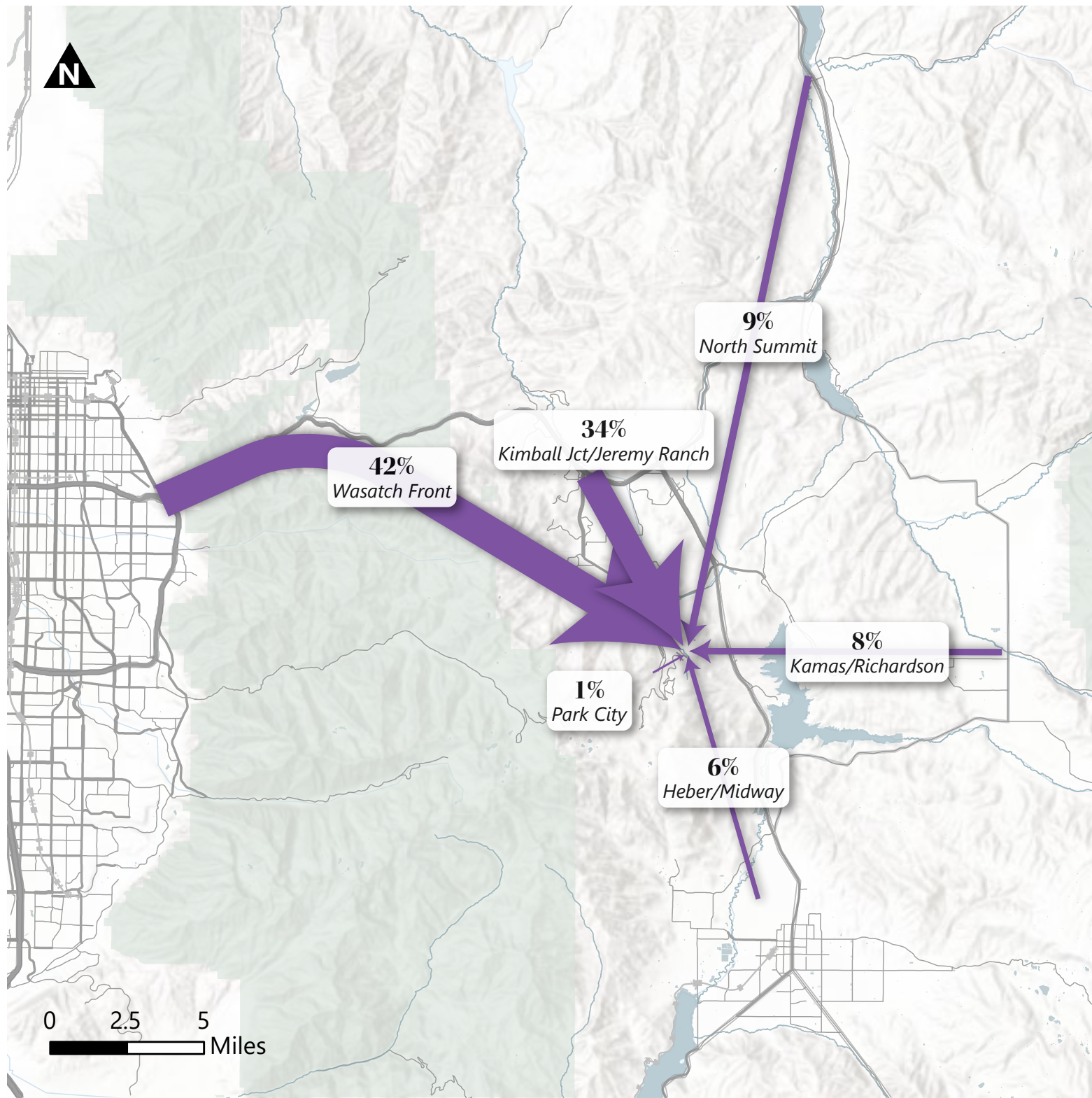

Figure 4  
Deer Valley Origin-Destination AM Incoming - PM Outgoing Trends 

## 4. Project Conditions

The Project conditions analysis evaluates the type and intensity of proposed development. This provides the basis for trip generation, distribution, and assignment of project trips to the surrounding study intersections defined in the Introduction. Additionally, Snow Park includes many proposed updates to the roadway network immediately adjacent to the site.

### 4.1 Project Description

The first phase of the proposed Snow Park Village development will be located at the south parcel of the Deer Valley Resort. The parcel is currently surface parking lots for Deer Valley. Deer Valley resort is in a cul-de-sac type of location, and all trips will access the development through the Deer Valley Drive / Deer Valley Drive East/ Deer Valley Drive West intersections. As a reminder, this traffic report accounts for all future development of the current surface parking lots.

#### 4.1.1 Site Access and Circulation

The Snow Park Village proposal includes mitigations at key intersections to provide better transit access, especially at the transit hub, and improve the traffic flow for visitors traveling by all modes. This circulation plan includes a seasonal one-way transit lane. It will function in a counterclockwise manner. After ski season, the transit lane will be open to bicycle traffic. Management and enforcement, year-round, will be a City responsibility.

**Deer Valley Drive West** will be largely left as it is today. The main entrance for day skiers is the western access off Doe Pass Road into the P2 level. The northbound approach at the Doe Pass Road / Deer Valley Drive West intersection will be stop-controlled. To improve pedestrian and bicycle connections, a continuous multiuse path will be constructed along the west curb to connect Snow Park Village to multimodal facilities along Deer Valley Drive and the broader Park City active transportation network. Adjacent to the Snow Park Village site, Deer Valley Drive West will be gated to control access to the Trails End development and to discourage use of the southern terminus of Deer Valley Drive West as a skier drop off area.

**Doe Pass Road** will be reconfigured to provide access to the parking structure and mobility hub entrances. Doe Pass Road will include two-way general traffic lanes to allow for the movement of public and private vehicles. A continuous sidewalk will be provided on the south side of Doe Pass Road, which will be connected to the multiuse path along the west curb of Deer Valley Drive West by controlled crossings. Two parking accesses, to levels P1 and P2, will be provided on Doe Pass Road. The parking structure will have



internal ramping to allow access between P2 and P3. Both driveways will be controlled with parking management technology, and Deer Valley staff as needed.

**Deer Valley Drive East** Two general traffic lanes and one transit flex lane will be provided on Deer Valley Drive East. A continuous multiuse path will be provided along the west side, which connects to other similar facilities around the Deer valley Drive loop. Deer Valley Drive East will act as the primary route by which day-skiers depart Snow Park Village, which will be supported by the reconfiguration of the Deer Valley Drive / Deer Valley Drive East / Deer Valley Drive West intersection and through intuitive, real-time wayfinding. South of its intersection with Doe Pass Road, Deer Valley Drive East will provide access to P2, P3 and P4 parking levels which will primarily serve day skiers. Driveways to these parking levels will be similarly managed through parking technology and Deer Valley staff during periods of peak demand. At its southern terminus, Deer Valley Drive East will be reconfigured into a turnaround drop-off area for day-skier traffic. This drop-off area will be heavily managed, particularly at peak drop-off and pick-up periods with Deer Valley staff directing traffic to ensure smooth operations and safe conditions for users.

A conceptual site plan, showing driveway locations and conceptual roadway configurations is shown in **Figure 5**.





Figure 5  
Conceptual Site Plan 



## 4.2 Trip Generation

Much research and case studies have been performed to better understand the transportation benefits of mixed-use development and transit-oriented development (TOD) over the past decade. “D” factors affect the way mixed-use developments generate trips. The “D” factors include:

- Density (*dwelling, jobs per acre*)
- Diversity (*mix of housing, jobs, retail*)
- Design (*connectivity, walkability*)
- Destinations (*regional accessibility*)
- Distance to Transit (*rail and bus proximity*)
- Development Scale (*population, jobs*)
- Demographics (*household size, income*)

Because of the “D” factors, mixed-use developments and TOD have a much higher distribution of mode split (split between walk, bike, transit, and vehicle) and generally result in lower single-occupant vehicle trips and parking demand. Research has shown that mixed-use developments and TOD generate one-third to two-thirds fewer trips than typical state-of-the-practice trip generation methodologies.

Trip generation for the proposed Snow Park Village was obtained from the *Institute of Transportation Engineers – 10th Edition Trip Generation Manual* (ITE Manual) and Fehr & Peers’ mixed-use development (MXD+) methodology via MainStreet, a Fehr & Peers web application that captures the traffic benefits of developments by looking at interactions among the mixture of land uses and patron usage of alternative modes (i.e. transit, bicycling, and/or walking). Since the beginning of this effort, a new edition of the *Trip Generation Manual* has been published, however, analyses presented in this report rely on 10<sup>th</sup> Edition trip generation rates. This is to be consistent with previous drafts, and rates presented in the updated *Trip Generation Manual* would likely lead to marginal (“noise”) reductions in trip generation estimates. MXD+ outputs are included in the appendix of this report.

The MXD+ trip generation methodology more accurately captures the trip-reducing benefits of mixed-use development projects and is used throughout the United States to help developers, agencies, and the public to quantify these trip reductions. The MXD+ trip generation model is promoted by the United States Environmental Protection Agency (EPA) and has been adopted by the American Society of Civil Engineers (ASCE), American Planning Association (APA), and many others as a recommended resource for trip generation of smart-growth developments. The MXD+ model uses ITE trip generation rates and applies additional variables to those trip generation rates. Some of the additional variables include:

- Employment

- (Population + Employment) per square mile
- Land area
- Total jobs / population diversity
- Number of intersections per square mile
- Employment within a mile; within
- Employment within a 30-minute trip by transit
- Average household size
- Vehicles owned per capita

Trip generation for the project was computed using trip generation rates published in the Institute of Transportation Engineers (ITE) Trip Generation, 10th Edition, 2017, with trip reductions based on Fehr & Peers' MXD+ methodology to account for the project's many complementary land uses and availability of transit. These reductions were further informed by inputs from the Summit County Travel Demand Model to better tailor results to local travel behavior. Snow Park Village is proposed to include following land uses (taken from the land use program dated October 2021):

- 30,900 square feet of ballroom/event center space
- 143 multifamily housing units
- 193 hotel rooms
- 25,900 square feet of commercial/retail space

The development is proposed to support the current Deer Valley Resort and other land uses in adjacent to the resort. It should be noted that the land uses supporting the ski resort will not be substantial traffic generators; rather, the ski resort will be the primary generator of traffic, and the support land uses serve as accessories to the resort. The current traffic accessing the ski resort were assumed to cover the trip generation for the ski resort and the support land uses independent of the Snow Park Village proposal. **Table 6** presents the Saturday daily, AM peak-hour, and PM peak-hour trip generation estimates for the entirety of the proposed Snow Park Village Project on both parcels north and south of Doe Pass Road, not only the proposed first phase (Village) south of Doe Pass Road.

#### 4.2.1.1 Resort Hotel Trip Generation Rates

Trip Generation estimates for the hotel uses included in the Snow Park Village proposal are based on observed trip generation rates recorded during the development of the 2018 Canyons Village Transportation Master Plan. While there are a handful of key factors that might result in trip generation rates closer to those in the original Snow Park Village Traffic Impact Study, including proximity to the interstate and other complementary land uses, estimates in this memorandum used the local rates recorded at the Canyons.

### 4.2.1.2 Assumed Mode Shift

To avoid double-counting potential reductions, the trip generation estimates in this memorandum rely solely on mode shift derived from the MXD methodology and underlying assumptions from the regional travel demand model. These reductions, which are shown in the columns titled “% Walk/Bike” and “% Transit,” are applied to all proposed land uses. This results in a more conservative and defensible analysis; however, it does not account for potential changes to transit service in Park City, including potential development of remote park and ride lots, and the world-class transit facility proposed as part of the Snow Park Village project. Potential mode shift to transit for those traveling to and from Deer Valley may be higher following such improvements.

### 4.2.1.3 Reduction in Vehicle Trips due to Implementation of Paid Parking

Charging for parking is a reliable method by which to influence mode choice, and Deer Valley intends to implement paid parking as part of the Snow Park Village proposal. Reductions in trip generation due to the implementation of paid parking at Deer Valley have been scaled back to present a more conservative estimate of how parking pricing will affect trip generation. While many Deer Valley clientele may be much less sensitive to additional costs associated with a day’s skiing than the general population, almost 45% of existing trips to and from Deer Valley start and end at points along the Wasatch Front, residents of which are more likely to alter their behavior based on willingness to pay. Lastly, reductions in trip generation due to the implementation of parking pricing are applied only to the resort hotel-, shopping center-, and event center-generated trips, since proposed residential uses at the site are unlikely to require that residents pay for parking on a daily basis.

### 4.2.1.4 Trip Internalization Derived from MXD

A fundamental element of the Snow Park Village proposal is to provide amenities, services, and entertainment options that complement each other and the ski resort itself. This means that peak-hour trips that might occur without complementary land uses are either delayed (so that they do not occur during the peak hours) or do not require a vehicle trip due to proximity of different uses. Trip internalization rates, presented in **Table 6** under the column heading “% Internal Capture” are applied only to the residential-, resort hotel-, and recreational community center-generated trips, and present a more conservative rate of internalization than presented in the original Snow Park Village traffic impact study.

#### 4.2.1.5 Trip Internalization Derived from Squaw Valley (Palisades Tahoe)

While the residential, hotel, and community center uses are expected to be destinations unto themselves that will generate a measurable number of peak-hour vehicle trips, the food service and retail uses (shown in **Table 6** as “Shopping Center”) are expected to almost exclusively serve guests already at Deer Valley rather than guests traveling to Deer Valley explicitly for those services.

To support this assumption, trip generation estimates for the shopping center uses in this memorandum rely on trip internalization estimates derived from an origin-destination survey conducted at the Squaw Valley, California resort in 2011. Surveys conducted showed that 95-97% of customers at dining and retail uses in a similar context (ski resort base village) were already at the village for other purposes, and did not travel solely for the dining/retail use. Reductions based on the data from Squaw Valley are presented under the column heading “% Resort Int. Capt.” And are applied only to the shopping center uses. We assume that employees for these uses will almost exclusively arrive and depart during off-peak periods, resulting in lower reductions for daily trips generated by the shopping center uses.

Trip generation for Snow Park Village is covered in greater detail in **Attachment A**. Detailed MXD+ outputs are also included in the appendix.



**Table 6: Snow Park Village Trip Generation**

Land Use <sup>1</sup>	Number of Units	Unit Type	Rate <sup>2</sup>	Daily Trip Generation <sup>3</sup>	% Entering <sup>4</sup>	% Exiting <sup>4</sup>	% Walk/Bike <sup>5</sup>	% Transit <sup>5</sup>	% Paid Parking <sup>7</sup>	% Internal Capture <sup>6</sup>	% Resort Int. Capt. <sup>9</sup>	Trips Entering	Trips Exiting	New Daily Trips
(220) - Multifamily Housing Low-Rise	143	Dwelling Unit	8.14	1,164	50%	50%	4.6%	3.0%	-	1.9%	-	527	527	<b>1,054</b>
(330) - Resort Hotel	193	Rooms	6.27	1,210	50%	50%	4.6%	3.0%	15.0%	1.9%	-	457	457	<b>914</b>
(820) - Shopping Center	25.9	1,000 Sq. Ft	46.12	1,195	50%	50%	4.6%	3.0%	15.0%	-	90.0%	47	47	<b>94</b>
(495) Recreational Community Center	30.9	1,000 Sq. Ft	9.10	281	50%	50%	4.6%	3.0%	15.0%	1.9%	-	107	107	<b>214</b>
<b>Net Weekday Trips</b>				<b>3,850</b>								<b>1,138</b>	<b>1,138</b>	<b>2,276</b>
Land Use <sup>1</sup>	Number of Units	Unit Type	Rate <sup>2</sup>	AM Peak Hour Trip Generation <sup>3</sup>	% Entering <sup>4</sup>	% Exiting <sup>4</sup>	% Walk/Bike <sup>5</sup>	% Transit <sup>5</sup>	% Paid Parking <sup>7</sup>	% Internal Capture <sup>6</sup>	% Resort Int. Capt. <sup>8</sup>	Trips Entering	Trips Exiting	New AM Peak Hour Trips
(220) - Multifamily Housing Low-Rise	143	Dwelling Unit	0.46	66	23%	77%	5.6%	1.9%	-	3.7%	-	14	45	<b>59</b>
(330) - Resort Hotel	193	Rooms	0.41	79	72%	28%	5.6%	1.9%	15.0%	3.7%	-	43	17	<b>60</b>
(820) - Shopping Center	25.9	1,000 Sq. Ft	0.94	24	62%	38%	5.6%	1.9%	15.0%	-	96.2%	1	1	<b>2</b>
(495) Recreational Community Center	30.9	1,000 Sq. Ft	1.76	54	62%	38%	5.6%	1.9%	15.0%	3.7%	-	25	16	<b>41</b>
<b>Net Saturday AM Peak Hour Trips</b>				<b>224</b>								<b>83</b>	<b>79</b>	<b>162</b>
Land Use <sup>1</sup>	Number of Units	Unit Type	Rate <sup>2</sup>	PM Peak Hour Trip Generation <sup>3</sup>	% Entering <sup>4</sup>	% Exiting <sup>4</sup>	% Walk/Bike <sup>5</sup>	% Transit <sup>5</sup>	% Paid Parking <sup>7</sup>	% Internal Capture <sup>6</sup>	% Resort Int. Capt. <sup>8</sup>	Trips Entering	Trips Exiting	New PM Peak Hour Trips
(220) - Multifamily Housing Low-Rise	143	Dwelling Unit	0.70	100	60%	40%	3.4%	2.9%	-	10.6%	-	50	34	<b>84</b>
(330) - Resort Hotel	193	Rooms	0.70	135	43%	57%	3.4%	2.9%	15.0%	10.6%	-	40	53	<b>93</b>
(820) - Shopping Center	25.9	1,000 Sq. Ft	4.50	117	52%	48%	3.4%	2.9%	15.0%	-	96.2%	2	2	<b>4</b>
(495) Recreational Community Center	30.9	1,000 Sq. Ft	1.07	33	52%	48%	3.4%	2.9%	15.0%	10.6%	-	12	11	<b>23</b>
<b>Net Saturday PM Peak Hour Trips</b>				<b>385</b>								<b>104</b>	<b>100</b>	<b>204</b>

1. (XXX) Indicates ITE Land Use Code. Land Use Code from the Institute of Transportation Engineers - 10th Edition Trip Generation Manual (ITE Manual)
  2. ITE Trip Generation Rates. Hotel rates derived from data collected on Saturday, February 17, 2018, for the Canyons Village Management Association Transportation Master Plan.
  3. Traffic Generated by the development according to trip generation rates provided in the ITE Manual (custom rates for Hotel).
  4. Percentage of trips Entering and Exiting the development according to the ITE Manual.
  5. Percentage of trips that shift to active transportation or transit modes based on data collected by U.S. Census Bureau, 2013-2017 American Community Survey 5-Year Estimates.
  6. Percentage of trips that are captured internally to the site based on rates published in ITE Manual.
  7. Percentage of trips that shift to transit due to parking costs based on Fehr & Peers's Parking Cost Tool. The tool estimates close to 20%; 15% assumed for conservative results.
  8. Percentage of trips that are captured internally to the site for retail/restaurant based on Squaw Valley winter overnight visitor survey conducted in 2011, for weekend AM and PM peak hours.
  9. Daily retail/restaurant internal capture percentage was assumed to be lower than AM and PM peak hours due to employees, which daily travel patterns are not as affected as much as peak hours.
- Source: Fehr & Peers

## 4.3 Trip Distribution and Assignment

Project traffic was assigned to the roadway network based on the proximity to major streets and freeways, population densities, and local and regional attractions. Existing travel patterns revealed in the Streetlight data, Continuous Count Station (CCS) data collection from UDOT, and observed during data collection also provided helpful guidance to establish these distribution percentages, especially close to the site.

The CCS data from UDOT informed the distribution of trips arriving via SR-224 and SR-248. Closer to the project site, Streetlight data informed the distribution of trips arriving via Marsac Avenue and Deer Valley Drive. Overall, the project-generated trips were distributed to and from these directions in the Existing analysis, in the corresponding percentages:

- 50% North (using SR-224)
- 20% East (using SR-248 via Bonanza Drive)
- 15% West (using any of the accesses along Deer Valley Drive between Bonanza and Marsac)
- 5% West (using the Transit Hub access at the Marsac Roundabout)
- 10% South (using Marsac Avenue)

This trip distribution does not fully align with the origin-destination data presented in **Figure 4** due to the expected differences in trip purpose stemming from the change in land use at Snow Park. The distribution and assignment of new, project-generated trips reflects the assumption that residents and guests of Snow Park Village’s hotel and residential uses are more likely to and from Old Town for dining, shopping, or entertainment purposes.

These trip distribution assumptions were used to distribute project-generated traffic to the study area intersections and are shown in **Figure 6**.

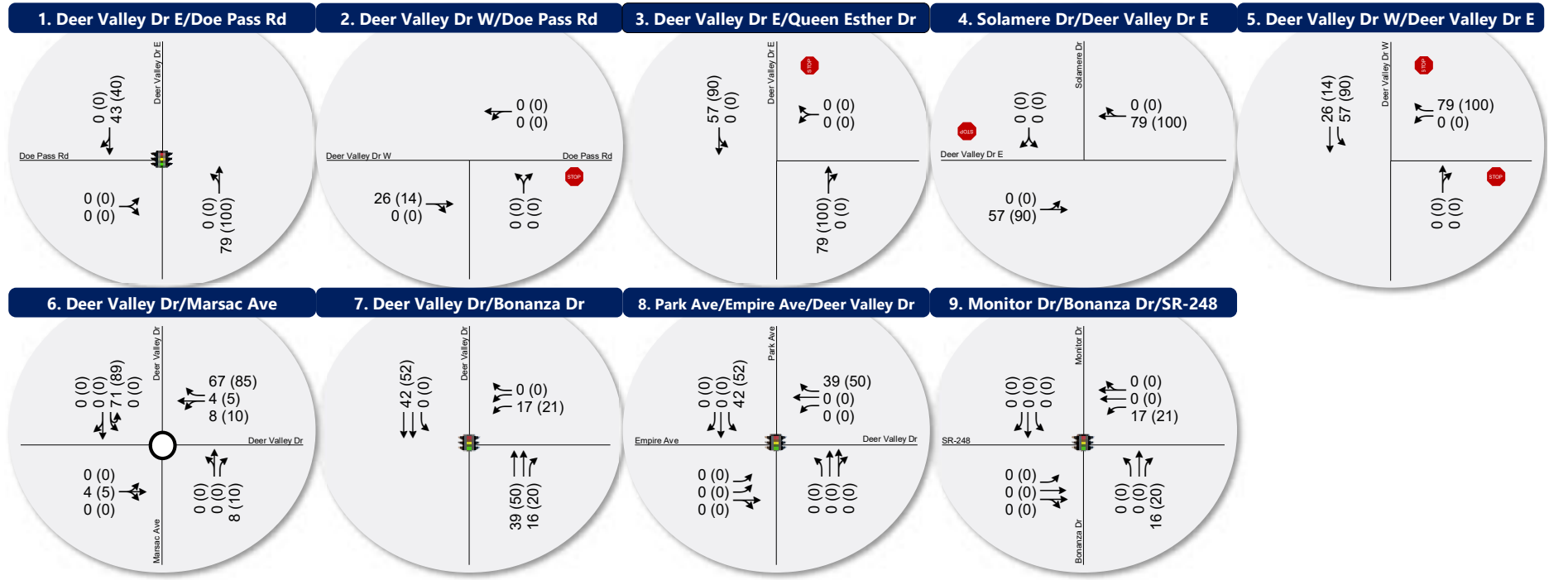

**LEGEND**

Stop Sign    
 Signalized    
 Roundabout

Lane Configuration:
   
 AM (PM)
   
 AM (PM)
   
 AM (PM)

Peak Hour Traffic Volume per lane

Intersection Level of Service (LOS):

Figure 6  
 Saturday AM & PM Peak Hour Trip Generation and Distribution

## 5. Existing 2020 plus Project Conditions

The Existing (2020) Plus Project conditions analysis evaluates the impact of the proposed development-generated traffic on the surrounding roadway network under existing conditions. To analyze this impact, the Saturday peak-hour background traffic volumes were combined with volumes generated by the proposed Project during its Saturday peak hours. Intersection LOS analyses were then performed and compared to the results of the background traffic volumes. This comparison shows the impact of the proposed project.

### 5.1 Traffic Volumes

Vehicle trips in and out of the existing Deer Valley resort are assumed to be for the ski resort users and were not subtracted out from the background volumes. Project-generated traffic for the additional land uses and development was added to the background volumes to yield Existing (2020) Plus Project peak-hour volumes. The Saturday AM and PM peak-hour traffic volumes at the study intersections are shown in **Figure 7**.



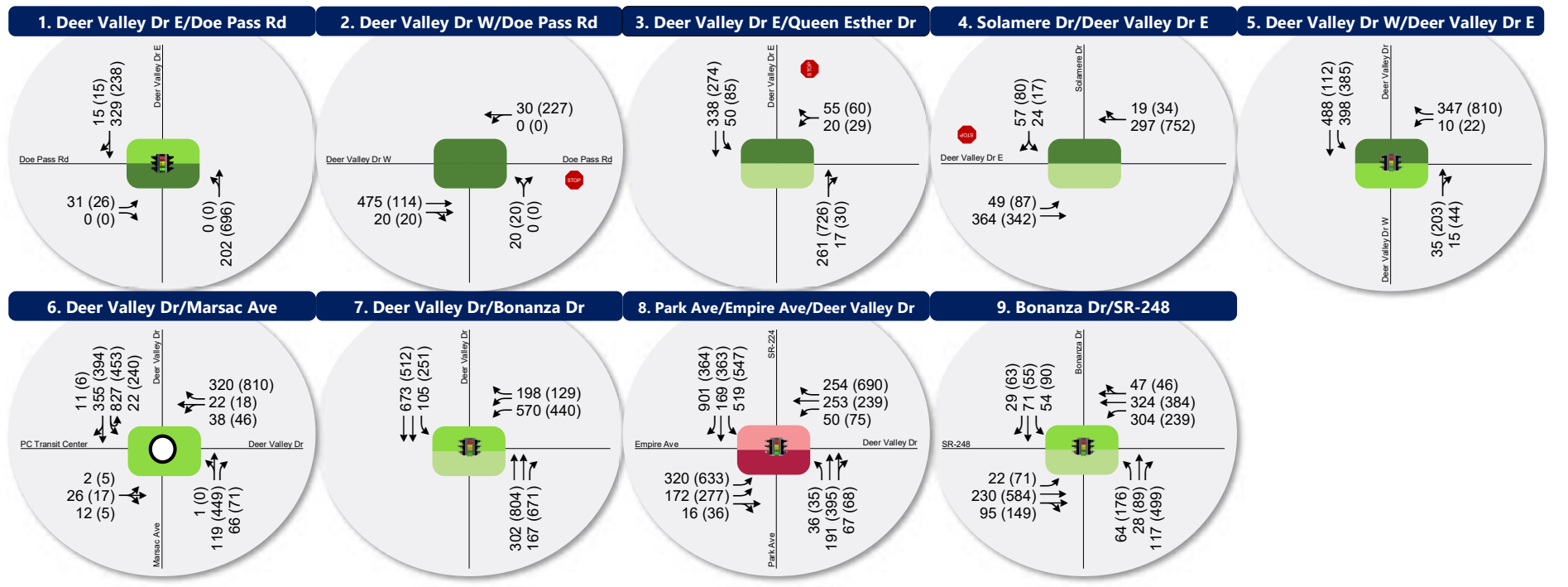

**LEGEND**

Stop Sign    
 Signalized    
 Roundabout

Lane Configuration:
   
 AM (PM)
   
 AM (PM)
   
 AM (PM)

Peak Hour Traffic Volume per lane

Intersection Level of Service (LOS):

A
B
C
D
E
F

Existing 2020 Plus Project Saturday AM & PM Peak Hour Traffic Conditions

## 5.2 Level of Service Analysis

Using SimTraffic simulation software (for signalized and unsignalized intersections) and SIDRA software (for the roundabout) and the HCM 6 delay thresholds provided in the Introduction, the existing 2020 plus project Saturday AM and PM peak hour LOS were computed for each study intersection. The results of the analysis are reported in **Table 7** (see Appendix for the detailed LOS report).

**Table 7: Existing 2020 plus Project Conditions Saturday AM & PM Peak Hour Level of Service**

Intersection				Worst Movement <sup>1</sup>			Overall Intersection <sup>2</sup>	
ID	Location	Period	Control	Movement <sup>3</sup>	Delay Sec/Veh	LOS	Avg. Delay Sec/Veh	LOS
1	Doe Pass Rd / Deer Valley Dr East	AM	Signal	-	-	-	2	A
		PM		-	-	-	2	A
2	Doe Pass Rd / Deer Valley Dr West	AM	SSSC <sup>4</sup>	NB Left	10	B	-	-
		PM		NB Left	12	B	-	-
3	Queen Esther Dr / Deer Valley Dr East	AM	SSSC	WB Left	7	A	-	-
		PM		WB Left	8	A	-	-
4	Deer Valley Dr East / Solamere Dr	AM	SSSC	SB Left	7	A	-	-
		PM		SB Left	13	B	-	-
5	Deer Valley Dr / Bonanza Dr	AM	Signal	-	-	-	11	B
		PM		-	-	-	<b>164</b>	<b>F</b>
6	Deer Valley Drive / Marsac Avenue	AM	Roundabout	-	-	-	12	B
		PM		-	-	-	13	B
7	Deer Valley Dr / Bonanza Dr	AM	Signal	-	-	-	11	B
		PM		-	-	-	26	C
8	Deer Valley Dr / Park Ave / Empire Ave	AM	Signal	-	-	-	<b>78</b>	<b>E</b>
		PM		-	-	-	<b>86</b>	<b>F</b>
9	Bonanza Dr / Monitor Dr / SR-248	AM	Signal	-	-	-	12	B
		PM		-	-	-	20	C

Notes:

**Bold text** indicates intersections operating below Park City's acceptable LOS threshold.

1. This represents the worst approach LOS and delay (seconds/vehicle) and is only reported for unsignalized intersections.
2. This represents the overall intersection LOS and delay (seconds/vehicle).
3. NB=Northbound, SB=Southbound, EB=Eastbound, WB=Westbound
4. Side-street stop control.

Source: Fehr & Peers.



As shown in **Table 7**, all study intersections operated within acceptable LOS (LOS C or better), with the exception of the following locations:

- Deer Valley Drive East / Deer Valley Drive West: LOS F in the PM peak hour
  - This is caused by the high traffic volumes exiting the Deer Valley Resort area making a westbound right turn onto Deer Valley Drive. The westbound approach is stop-controlled, making it difficult for vehicles to find a gap and turn onto Deer Valley Drive West.
- Deer Valley Drive / Park Avenue / Empire Avenue: LOS E in the AM peak hour, LOS F in the PM peak hour
  - This is caused by high congestion at the signal due to high volumes accessing various ski resorts and downtown Park City.

It should be noted that the proposed Snow Park Village development introduces various support land uses intended to attract resort users to stay on-site after the ski resort peak hour. This will help distribute the peaking of traffic, reducing delays at the study intersections and roadways. Therefore, the results shown in **Table 7** are likely overstated.

## 5.3 Mitigation Measures

The Snow Park Village site plan includes realignment of the Deer Valley Drive / Deer Valley Drive East / Deer Valley Drive West intersection. The intersection is currently a “T”-intersection with free-flow movement north/south along Deer Valley Drive West / Deer Valley Drive, and a stop-control on the approach of Deer Valley Drive East. The proposed plan adds a signal at the intersection, as shown in **Figure 8**. Deer Valley Drive West will serve as a primary transit and auto route to access the proposed transit hub and the main P2 parking level entrance on Doe Pass Road and serve private vehicles accessing Royal Street and the Trail’s End community. Deer Valley Drive East will serve as the secondary vehicular route to access the Snow Park drop-off/pick-up area and parking structure accesses that includes day skier spaces, hotel, and residences.

To account for this shift in traffic on Deer Valley Drives East and West stemming from intersection realignment, proposed wayfinding, and the placement of site access along Deer Valley Drive East, analyses presented in this report assume that roughly 40% of the total traffic would use Deer Valley Drive East and roughly 60% of the total traffic would use Deer Valley Drive West inbound in the AM peak hour, and roughly 80% of the traffic would use Deer Valley Drive East and roughly 20% of the traffic would use Deer Valley Drive West outbound in the PM peak hour. This yields conservative results with regards to changes in travel behavior and will rely on various on- and off-site improvements to be realistically achieved. Background traffic was shifted and modified to account for the proposed shift in circulation. Importantly, this distribution of traffic accounts for the relocation of key drop-off points for ski school, other Deer Valley-run programs,



and general skier traffic, as well as the quantity of parking accessible via driveways on Doe Pass Road (presumably accessed via Deer Valley Drive West) and Deer Valley Drive East. This is a change from the existing traffic distribution, but not so drastic a shift that the assumed distribution is unrealistic. Results from a sensitivity analysis on alternative traffic distributions and downstream effects is presented in Section 11 of this report.

Park City has a longstanding position of not mitigating certain deficient intersections within its boundaries due to the impacts of road widening and other potential mitigations to the community. As a result, potential mitigations at the intersections of Deer Valley Drive / Park Avenue / Empire Avenue, Bonanza Drive / Monitor Drive / SR-248 were not analyzed as part of this study, and are therefore not included as recommendations. Further, deficiencies shown at the intersection of Deer Valley Drive / Bonanza Drive are not a result of project-generated trips or operations of the intersection itself; instead they stem from vehicle queues from the intersection of Deer Valley Drive / Park Avenue / Empire Avenue. As a result, mitigations at the intersection of Deer Valley Drive / Bonanza Drive are not recommended as part of this study. As stated earlier, Deer Valley Drive between the roundabout and SR-224 intersection is a UDOT facility. Any efforts to improve traffic will be led by UDOT.

The analysis results with the reconfigured Deer Valley Drive East / Deer Valley Drive West intersection are shown in **Table 8** (see Appendix for the detailed LOS report). As shown in **Table 8**, the Deer Valley Drive / Deer Valley Drive East / Deer Valley Drive West intersection operates at LOS A and LOS B in the AM and PM peak hours, respectively.

With the redistributed traffic due to the proposed circulation, the Deer Valley Drive East / Solamere Drive and Deer Valley Drive East / Queen Esther Drive intersections experience increased delays. As a mitigation, the Snow Park Village site plan includes new left-turn pockets at both the Deer Valley Drive East / Solamere Drive and Deer Valley Drive East / Queen Esther Drive intersections to improve traffic operations during peak periods and better facilitate inbound left turns, as well as a receiving lane to allow for two-stage left turns out of Solamere Drive and Queen Esther Drive.

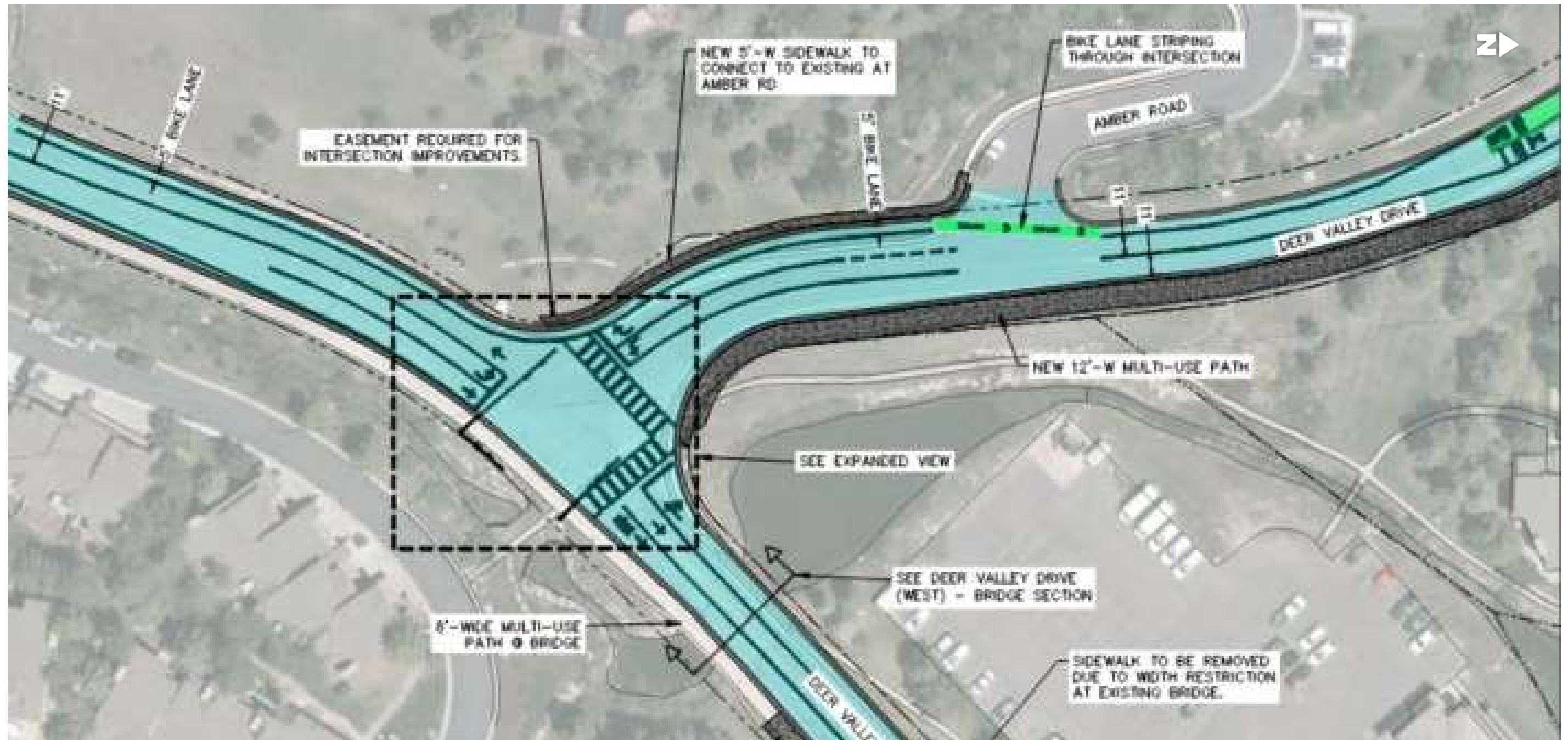

Source: Alliance Engineering Inc

Figure 8  
 Proposed Reconfiguration of Deer Valley Drive East / Deer Valley Drive West Intersection - Transit Priority Alternative

**Table 8: Existing 2020 plus Project Mitigated Conditions Saturday AM & PM Peak Hour Level of Service**

Intersection				Worst Movement <sup>1</sup>			Overall Intersection <sup>2</sup>	
ID	Location	Period	Control	Movement <sup>3</sup>	Delay Sec/Veh	LOS	Avg. Delay Sec/Veh	LOS
1	Doe Pass Rd / Deer Valley Dr East	AM	Signal	-	-	-	15	B
		PM		-	-	-	5	A
2	Doe Pass Rd / Deer Valley Dr West	AM	SSSC <sup>4</sup>	NB Left	7	A	-	-
		PM		NB Left	5	A	-	-
3	Queen Esther Dr / Deer Valley Dr East	AM	SSSC	WB Left	8	A	-	-
		PM		WB Left	15	C	-	-
4	Deer Valley Dr East / Solamere Dr	AM	SSSC	SB Left	8	A	-	-
		PM		SB Left	20	C	-	-
5	Deer Valley Dr / Deer Valley Dr East / Deer Valley Dr West	AM	Signal	-	-	-	7	A
		PM		-	-	-	17	B
6	Deer Valley Drive / Marsac Avenue	AM	Roundabout	-	-	-	12	B
		PM		-	-	-	13	B
7	Deer Valley Dr / Bonanza Dr	AM	Signal	-	-	-	11	B
		PM		-	-	-	24	C
8	Deer Valley Dr / Park Ave / Empire Ave	AM	Signal	-	-	-	<b>76</b>	<b>E</b>
		PM		-	-	-	<b>87</b>	<b>F</b>
9	Bonanza Dr / Monitor Dr / SR-248	AM	Signal	-	-	-	13	B
		PM		-	-	-	20	C

Notes:

**Bold text** indicates intersections operating below Park City's acceptable LOS threshold.

1. This represents the worst approach LOS and delay (seconds/vehicle) and is only reported for unsignalized intersections.
2. This represents the overall intersection LOS and delay (seconds/vehicle).
3. NB=Northbound, SB=Southbound, EB=Eastbound, WB=Westbound

Source: Fehr & Peers.

## 6. Opening Year (2024) Background Conditions

The purpose of the Opening Year (2024) Background conditions analysis is to evaluate the study intersections during the peak travel periods of the day under projected 2024 traffic volumes, when the development is projected to open. This analysis provides a baseline condition for the year 2024, which can be used to determine future Project impacts.

### 6.1 Traffic Volumes

Traffic volumes for 2024 were estimated using traffic counts and forecasted volumes from the Summit/Wasatch Travel Demand Model (September 2020 version) for 2024. This is a regional forecasting model developed with UDOT support to help plan for major infrastructure in the Wasatch Back region. The Summit/Wasatch Travel Demand Model shows a lower annual growth rate in the future by accounting for a higher mode split for non-drive alone modes of transportation – higher usage of transit, walking, and biking than previous versions of travel demand models. The following annual growth rates were used on the following roadways to project 2024 background weekday volumes as shown in **Figure 9**.

- 0.5% on Deer Valley Drive (SR-224) north of Bonanza Drive
- 0.5% on Deer Valley Drive (SR-224) south of Bonanza Drive
- 0.5% on Deer Valley Drive (SR-224) north of Marsac Avenue
- 0.6% on Deer Valley Drive (SR-224) east of Marsac Avenue
- 0.6% on Deer Valley Drive (SR-224) north of Deer Valley Drive West
- 0.4% on Deer Valley Drive (SR-224) south of Deer Valley Drive West
- 1.7% on Bonanza Drive
- 0.3% on Marsac Avenue

### 6.2 Level of Service Analysis

Using SimTraffic simulation software (for signalized and unsignalized intersections) and SIDRA software (for the roundabout) and the HCM 6 delay thresholds provided in the Introduction, opening year 2024 background weekday peak hour LOS was computed for each study intersection. The results of this analysis for the Saturday AM and PM peak hour are reported in **Table 9** (see Appendix for the detailed LOS report).

**Table 9: Opening Year 2024 Background Conditions Saturday AM & PM Peak Hour Level of Service**

Intersection				Worst Movement <sup>1</sup>			Overall Intersection <sup>2</sup>	
ID	Location	Period	Control	Movement <sup>3</sup>	Delay Sec/Veh	LOS	Avg. Delay Sec/Veh	LOS
1	Doe Pass Rd / Deer Valley Dr East	AM	SSSC <sup>4</sup>	-	-	-	-	-
		PM		-	-	-	-	-
2	Doe Pass Rd / Deer Valley Dr West	AM	SSSC	-	-	-	-	-
		PM		-	-	-	-	-
3	Queen Esther Dr / Deer Valley Dr East	AM	SSSC	WB Left	6	A	-	-
		PM		WB Left	8	A	-	-
4	Deer Valley Dr East / Solamere Dr	AM	SSSC	SB Left	6	A	-	-
		PM		SB Left	11	B	-	-
5	Deer Valley Dr / Deer Valley Dr East / Deer Valley Dr West	AM	SSSC	WB Left	14	B	-	-
		PM		WB Left	<b>41</b>	<b>E</b>	-	-
6	Deer Valley Drive / Marsac Avenue	AM	Roundabout	-	-	-	11	B
		PM		-	-	-	11	B
7	Deer Valley Dr / Bonanza Dr	AM	Signal	-	-	-	11	B
		PM		-	-	-	20	C
8	Deer Valley Dr / Park Ave / Empire Ave	AM	Signal	-	-	-	<b>82</b>	<b>F</b>
		PM		-	-	-	<b>85</b>	<b>F</b>
9	Bonanza Dr / Monitor Dr / SR-248	AM	Signal	-	-	-	13	B
		PM		-	-	-	20	C

Notes:

**Bold text** indicates intersections operating below Park City's acceptable LOS threshold.

1. This represents the worst approach LOS and delay (seconds/vehicle) and is only reported for unsignalized intersections.
2. This represents the overall intersection LOS and delay (seconds/vehicle) and is only reported for signalized intersections and roundabouts.
3. NB=Northbound, SB=Southbound, EB=Eastbound, WB=Westbound
4. Side-street stop control.

Source: Fehr & Peers.

As shown in **Table 9**, all study intersections operated within acceptable LOS (LOS C or better), with the exception of the following locations:

- Deer Valley Drive East / Deer Valley Drive West: LOS E in the PM peak hour
  - This is caused by the high volumes of vehicles exiting the Deer Valley Resort area making a westbound right turn onto Deer Valley Drive West. The westbound approach is stop-controlled, making it difficult for vehicles to find a gap and turn onto Deer Valley Drive West.





- Deer Valley Drive / Park Avenue / Empire Avenue: LOS F in both AM and PM peak hours
  - This is caused by high congestion at the signal due to high volumes accessing various ski resorts and downtown Park City.

It should be noted that while the Bonanza Drive / Deer Valley Drive intersection operates within acceptable LOS, it is often impacted by vehicle queues spilling back to this intersection from the upstream intersection at Deer Valley Drive / Park Avenue / Empire Avenue in the PM peak hour.

## 6.3 Mitigation Measures

The concept master plan for Snow Park Village shows re-alignment and signalization of the Deer Valley Drive East / Deer Valley Drive West intersection, which will alter the westbound LOS at this intersection. Therefore, Fehr & Peers does not recommend any mitigation measures for opening year background conditions.

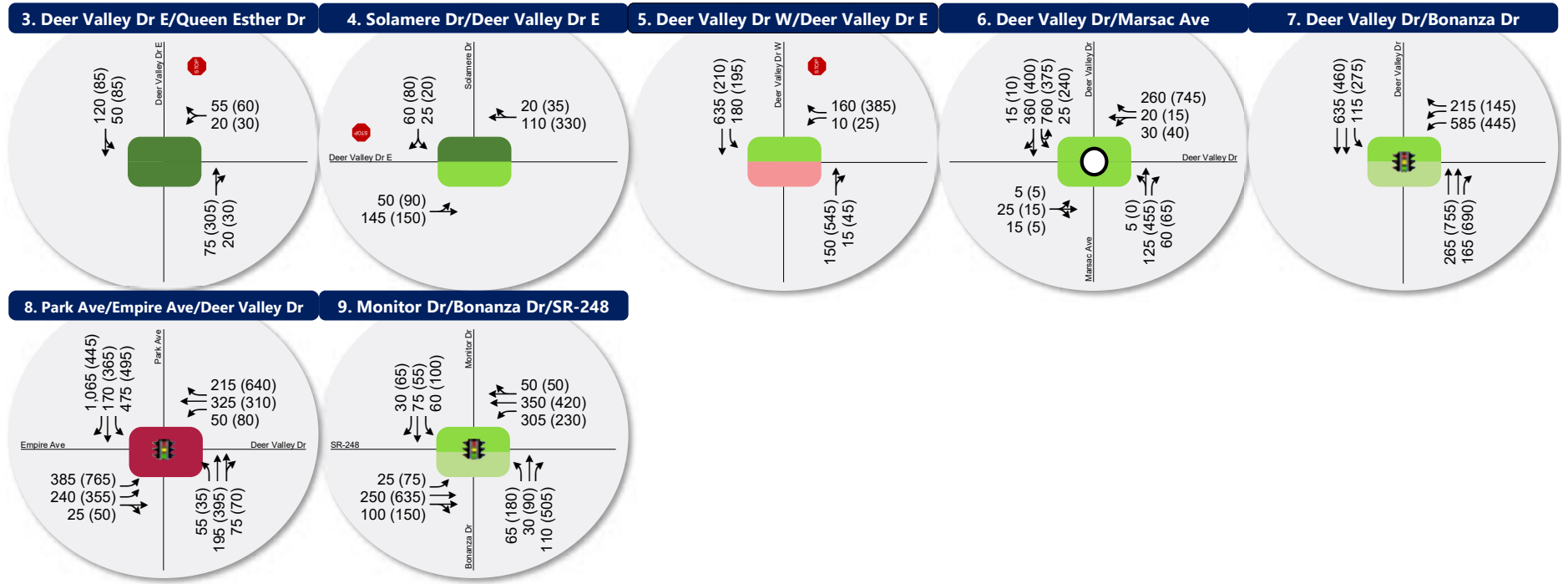

**LEGEND**

Stop Sign    
 Signalized    
 Roundabout

Lane Configuration: AM (PM) Traffic Volume per lane

Intersection Level of Service (LOS):

**A**  
 **B**  
 **C**  
 **D**  
 **E**  
 **F**

Opening Year 2024 Background Saturday AM & PM Peak Hour Traffic Conditions

## 7. Opening Year (2024) Plus Project Conditions

The purpose of the opening year 2024 plus project conditions analysis is to evaluate the impact of the proposed development traffic on the surrounding roadway network in the year 2024, the proposed opening year of the development. To analyze this impact, the projected 2024 Saturday AM and PM peak hour background traffic volumes were combined with volumes generated by the development for the Saturday AM and PM peak hours. Intersection LOS analyses were then performed and compared to the results of the background traffic volumes. This comparison shows the impact of the proposed project in opening year 2024.

### 7.1 Traffic Volumes

Project-generated traffic (**Figure 6**) was added to the opening year 2024 background volumes (**Figure 9**) to yield Opening Year (2024) Plus Project Saturday AM and PM peak-hour traffic volumes at the study intersections as shown in **Figure 10**.

### 7.2 Level of Service Analysis

Using SimTraffic simulation software (for signalized and unsignalized intersections) and SIDRA software (for the roundabout) and the HCM 6 delay thresholds provided in the Introduction, opening year 2024 plus project Saturday AM and PM peak hour LOS were computed for each study intersection. The results of the analysis are reported in **Table 10** (see Appendix for the detailed LOS report).

**Table 10: Opening Year 2024 plus Project Conditions Saturday AM & PM Peak Hour Level of Service**

Intersection				Worst Movement <sup>1</sup>			Overall Intersection <sup>2</sup>	
ID	Location	Period	Control	Movement <sup>3</sup>	Delay Sec/Veh	LOS	Avg. Delay Sec/Veh	LOS
1	Doe Pass Rd / Deer Valley Dr East	AM	Signal	-	-	-	2	A
		PM		-	-	-	2	A
2	Doe Pass Rd / Deer Valley Dr West	AM	SSSC <sup>4</sup>	NB Left	10	B	-	-
		PM		NB Left	15	B	-	-
3	Queen Esther Dr / Deer Valley Dr East	AM	SSSC	WB Left	7	A	-	-
		PM		WB Left	10	B	-	-
4	Deer Valley Dr East / Solamere Dr	AM	SSSC	SB Left	8	A	-	-
		PM		SB Left	12	B	-	-
5	Deer Valley Dr / Deer Valley Dr East / Deer Valley Dr West	AM	SSSC	WB Left	13	B	-	-
		PM		WB Right	<b>74</b>	<b>F</b>	-	-
6	Deer Valley Drive / Marsac Avenue	AM	Roundabout	-	-	-	13	B
		PM		-	-	-	14	B
7	Deer Valley Dr / Bonanza Dr	AM	Signal	-	-	-	12	B
		PM		-	-	-	24	C
8	Deer Valley Dr / Park Ave / Empire Ave	AM	Signal	-	-	-	<b>79</b>	<b>E</b>
		PM		-	-	-	<b>88</b>	<b>F</b>
9	Bonanza Dr / Monitor Dr / SR-248	AM	Signal	-	-	-	13	B
		PM		-	-	-	21	C

Notes:

**Bold text** indicates intersections operating below Park City's acceptable LOS threshold.

1. This represents the worst approach LOS and delay (seconds/vehicle) and is only reported for unsignalized intersections.
2. This represents the overall intersection LOS and delay (seconds/vehicle).
3. NB=Northbound, SB=Southbound, EB=Eastbound, WB=Westbound
4. Side-street stop control.

Source: Fehr & Peers.

As shown in **Table 10**, all study intersections operated within acceptable LOS (LOS C or better), with the exception of the following locations:

- Deer Valley Drive East / Deer Valley Drive West: LOS F in the PM peak hour
  - This is caused by the high traffic volumes exiting the Deer Valley Resort area making a westbound right turn onto Deer Valley Drive. The westbound approach is stop-controlled, making it difficult for vehicles to find a gap and turn onto Deer Valley Drive West.

- Deer Valley Drive / Park Avenue / Empire Avenue: LOS E in the AM peak hour, LOS F in the PM peak hour
  - This is caused by high congestion at the signal due to high volumes accessing various ski resorts and downtown Park City

It should be noted that the proposed Snow Park Village development introduces various support land uses intended to attract resort users to stay on-site after the ski resort peak hour. This will help distribute the peaking of traffic, reducing delays at the study intersections and roadways. Therefore, the results shown in **Table 10** are likely overstated.

## 7.3 Mitigation Measures

The Snow Park Village site plan includes realignment of the Deer Valley Drive / Deer Valley Drive East / Deer Valley Drive West intersection. The intersection is currently a “T”-intersection with free-flow movement north/south along Deer Valley Drive West / Deer Valley Drive, and a stop-control on the approach of Deer Valley Drive East. The proposed plan adds a signal at the intersection as shown in **Figure 8**. Deer Valley Drive West will serve as a primary transit and auto route to access the proposed transit hub and the main P2 parking level entrance on Doe Pass Road, and serve private vehicles accessing Royal Street and the Trail’s End community. Deer Valley Drive East will serve as the secondary vehicular route to access the Snow Park drop-off/pick-up area and parking structure accesses that includes day skier spaces, hotel, and residences.

To account for this shift in traffic on Deer Valley Drives East and West stemming from intersection realignment, proposed wayfinding, and the placement of site access along Deer Valley Drive East, analyses presented in this report assume that roughly 40% of the total traffic would use Deer Valley Drive East and roughly 60% of the total traffic would use Deer Valley Drive West inbound in the AM peak hour, and roughly 80% of the traffic would use Deer Valley Drive East and roughly 20% of the traffic would use Deer Valley Drive West outbound in the PM peak hour. This yields conservative results with regards to changes in travel behavior and will rely on various on- and off-site improvements to be realistically achieved. Background traffic was shifted and modified to account for the proposed shift in circulation.

Park City has a longstanding position of not mitigating certain deficient intersections within its boundaries due to the impacts of road widening and other potential mitigations to the community. As a result, potential mitigations at the intersections of Deer Valley Drive / Park Avenue / Empire Avenue, Bonanza Drive / Monitor Drive / SR-248 were not analyzed as part of this study, and are therefore not included as recommendations. Further, deficiencies shown at the intersection of Deer Valley Drive / Bonanza Drive are not a result of project-generated trips or operations of the intersection itself; instead they stem from vehicle queues from the intersection of Deer Valley Drive / Park Avenue / Empire Avenue. As a result, mitigations at the





intersection of Deer Valley Drive / Bonanza Drive are not recommended as part of this study. As stated earlier, Deer Valley Drive between the roundabout and SR-224 intersection is a UDOT facility. Any efforts to improve traffic will be led by UDOT.

The analysis results with the reconfigured Deer Valley Drive East / Deer Valley Drive West intersection are shown in **Table 11** (see Appendix for the detailed LOS report). As shown in **Table 11**, the Deer Valley Drive / Deer Valley Drive East / Deer Valley Drive West intersection operates at LOS C and LOS B in the AM and PM peak hour, respectively.

With the redistributed traffic due to the proposed circulation, the Deer Valley Drive East / Solamere Drive and Deer Valley Drive East / Queen Esther Drive intersections experience increased delays. As a mitigation, the Snow Park Village site plan includes new left-turn pockets at both the Deer Valley Drive East / Solamere Drive and Deer Valley Drive East / Queen Esther Drive intersections to improve traffic operations during peak periods and better facilitate inbound left turns, as well as a receiving lane to allow for two-stage left turns out of Solamere Drive and Queen Esther Drive.



**Table 11: Opening Year 2024 plus Project Mitigated Conditions Saturday AM & PM Peak Hour Level of Service**

Intersection				Worst Movement <sup>1</sup>			Overall Intersection <sup>2</sup>	
ID	Location	Period	Control	Movement <sup>3</sup>	Delay Sec/Veh	LOS	Avg. Delay Sec/Veh	LOS
1	Doe Pass Rd / Deer Valley Dr East	AM	Signal	-	-	-	16	B
		PM		-	-	-	5	A
2	Doe Pass Rd / Deer Valley Dr West	AM	SSSC <sup>4</sup>	NB Left	8	A	-	-
		PM		NB Left	7	A	-	-
3	Queen Esther Dr / Deer Valley Dr East	AM	SSSC	WB Left	7	A	-	-
		PM		WB Left	16	C	-	-
4	Deer Valley Dr East / Solamere Dr	AM	SSSC	SB Left	7	A	-	-
		PM		SB Left	18	C	-	-
5	Deer Valley Dr / Deer Valley Dr East / Deer Valley Dr West	AM	Signal	-	-	-	7	A
		PM		-	-	-	16	B
6	Deer Valley Drive / Marsac Avenue	AM	Roundabout	-	-	-	13	B
		PM		-	-	-	14	B
7	Deer Valley Dr / Bonanza Dr	AM	Signal	-	-	-	12	B
		PM		-	-	-	24	C
8	Deer Valley Dr / Park Ave / Empire Ave	AM	Signal	-	-	-	<b>78</b>	<b>E</b>
		PM		-	-	-	<b>88</b>	<b>F</b>
9	Bonanza Dr / Monitor Dr / SR-248	AM	Signal	-	-	-	13	B
		PM		-	-	-	23	C

Notes:

**Bold text** indicates intersections operating below Park City's acceptable LOS threshold.

1. This represents the worst approach LOS and delay (seconds/vehicle) and is only reported for unsignalized intersections.
2. This represents the overall intersection LOS and delay (seconds/vehicle).
3. NB=Northbound, SB=Southbound, EB=Eastbound, WB=Westbound

Source: Fehr & Peers.

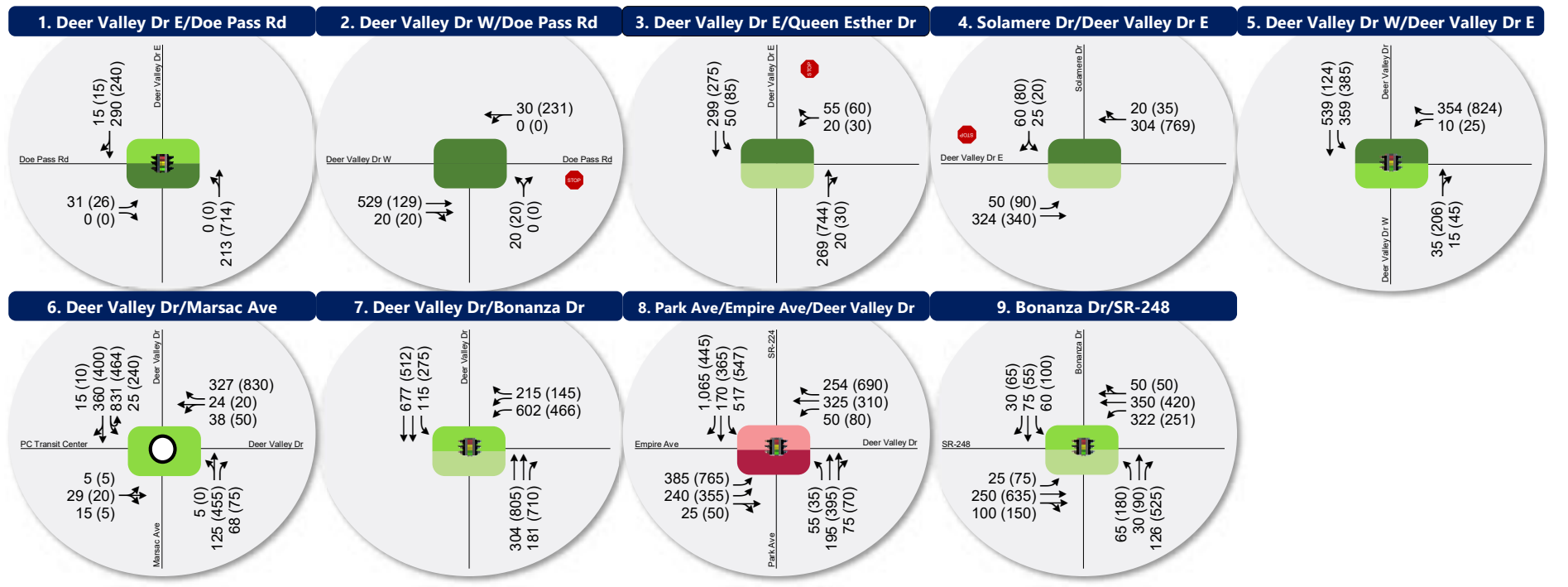

**LEGEND**

Stop Sign    
 Signalized    
 Roundabout

Lane Configuration:
   
 AM (PM) } Peak Hour Traffic Volume per lane
   
 AM (PM) }
   
 AM (PM) }

Intersection Level of Service (LOS):

A
B
C
D
E
F

Opening Year 2024 Plus Project Saturday AM & PM Peak Hour Traffic Conditions



## 8. Future 2040 Background Conditions

The purpose of the future 2040 background conditions analysis is to evaluate the study intersections during peak travel periods under projected 2040 traffic volumes. This analysis provides a baseline condition for the year 2040, which can be used to determine future project impacts.

### 8.1 Traffic Volumes

Traffic volumes for 2040 were estimated using traffic counts and forecasted volumes from the Summit/Wasatch Travel Demand Model (September 2020 version) for 2040. The Summit/Wasatch Travel Demand Model shows a lower annual growth rate in the future by accounting for a higher mode split of transportation – higher usage of transit, walking, and biking than previous versions of travel demand models. The following annual growth rates used on the following roadways to project 2040 background weekday volumes as shown in **Figure 11**.

- 0.3% on Deer Valley Drive (SR-224) north of Bonanza Drive
- 0.7% on Deer Valley Drive (SR-224) south of Bonanza Drive
- 0.6% on Deer Valley Drive (SR-224) north of Marsac Avenue
- 0.9% on Deer Valley Drive (SR-224) east of Marsac Avenue
- 1.0% on Deer Valley Drive (SR-224) north of Deer Valley Drive West
- 0.8% on Deer Valley Drive (SR-224) south of Deer Valley Drive West
- 1.2% on Bonanza Drive
- 0.4% on Marsac Avenue

Based on the understanding that much of the lower Deer Valley is effectively built out, traffic volumes on Solamere Drive and Queen Esther Drive were not increased for future scenarios.

### 8.2 Level of Service Analysis

Using SimTraffic simulation software (for signalized and unsignalized intersections) and SIDRA software (for the roundabout) and the HCM 6 delay thresholds provided in the Introduction, future 2040 background weekday peak hour LOS was computed for each study intersection. The results of this analysis for the AM & PM peak hour are reported in **Table 12** (see Appendix for the detailed LOS report).

**Table 12: Future 2040 Background Conditions Saturday AM & PM Peak Hour Level of Service**

Intersection				Worst Movement <sup>1</sup>			Overall Intersection <sup>2</sup>	
ID	Location	Period	Control	Movement <sup>3</sup>	Delay Sec/Veh	LOS	Avg. Delay Sec/Veh	LOS
1	Doe Pass Rd / Deer Valley Dr East	AM	SSSC <sup>4</sup>	-	-	-	-	-
		PM		-	-	-	-	-
2	Doe Pass Rd / Deer Valley Dr West	AM	SSSC	-	-	-	-	-
		PM		-	-	-	-	-
3	Queen Esther Dr / Deer Valley Dr East	AM	SSSC	WB Left	7	A	-	-
		PM		WB Left	9	A	-	-
4	Deer Valley Dr East / Solamere Dr	AM	SSSC	SB Left	8	A	-	-
		PM		SB Left	15	C	-	-
5	Deer Valley Dr / Deer Valley Dr East / Deer Valley Dr West	AM	SSSC	WB Left	17	C	-	-
		PM		WB Right	<b>112</b>	<b>F</b>	-	-
6	Deer Valley Drive / Marsac Avenue	AM	Roundabout	-	-	-	16	C
		PM		-	-	-	11	B
7	Deer Valley Dr / Bonanza Dr	AM	Signal	-	-	-	18	B
		PM		-	-	-	<b>59</b>	<b>E</b>
8	Deer Valley Dr / Park Ave / Empire Ave	AM	Signal	-	-	-	<b>83</b>	<b>F</b>
		PM		-	-	-	<b>90</b>	<b>F</b>
9	Bonanza Dr / Monitor Dr / SR-248	AM	Signal	-	-	-	16	B
		PM		-	-	-	28	C

Notes:

**Bold text** indicates intersections operating below Park City's acceptable LOS threshold.

1. This represents the worst approach LOS and delay (seconds/vehicle) and is only reported for unsignalized intersections.
2. This represents the overall intersection LOS and delay (seconds/vehicle) and is only reported for signalized intersections and roundabouts.
3. NB=Northbound, SB=Southbound, EB=Eastbound, WB=Westbound
4. Side-street stop control.

Source: Fehr & Peers.

As shown in **Table 12**, all study intersections operated within acceptable LOS (LOS C or better), with the exception of the following locations:

- Deer Valley Drive East / Deer Valley Drive West: LOS F in the PM peak hour
  - This is caused by the high volumes of vehicles exiting the Deer Valley Resort area making a westbound right turn onto Deer Valley Drive West. The westbound approach is stop-controlled, making it difficult for vehicles to find a gap and turn onto Deer Valley Drive West.



- Deer Valley Drive / Bonanza Drive: LOS E in the PM peak hour
  - This is caused by vehicle queues spilling back to this intersection from the upstream intersection at Deer Valley Drive / Park Avenue / Empire Avenue.
- Deer Valley Drive / Park Avenue / Empire Avenue: LOS F in both AM and PM peak hours
  - This is caused by high congestion at the signal due to high volumes accessing various ski resorts and downtown Park City.

## 8.3 Mitigation Measures

The site plan for the concept master plan for Snow Park Village shows re-alignment and signalization of the Deer Valley Drive East / Deer Valley Drive West intersection, which will alter the westbound LOS at this intersection. Therefore, Fehr & Peers does not recommend any mitigation measures for future 2040 background conditions.



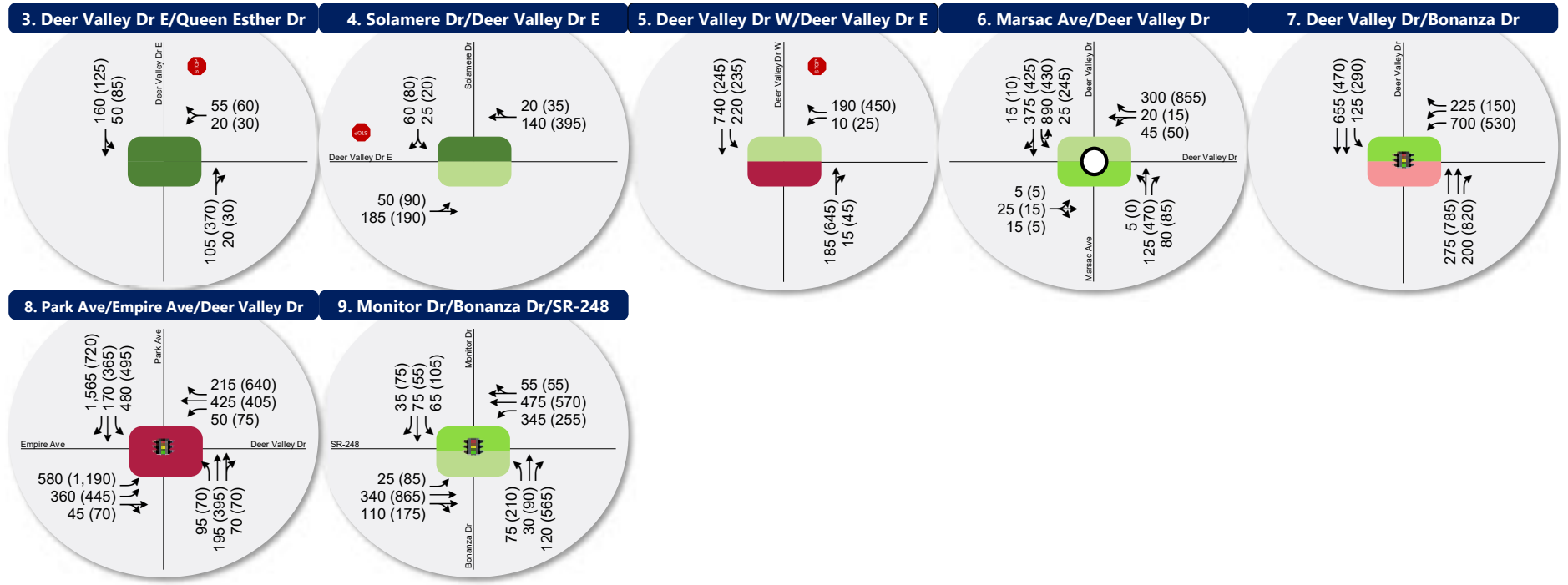

**LEGEND**

Stop Sign    
 Signalized    
 Roundabout

Lane Configuration:
   
 AM (PM)
   
 AM (PM)
   
 AM (PM)

Peak Hour Traffic Volume per lane

Intersection Level of Service (LOS):

AM/PM    
 A    
 B    
 C    
 D    
 E    
 F

Figure 11  
 Future 2040 Background Saturday AM & PM Peak hour Traffic Conditions



## 9. Future 2040 plus Project Conditions

### 9.1 Purpose

The purpose of the future 2040 plus project conditions analysis is to evaluate the impact of the proposed development traffic on the surrounding roadway network in the year 2040. To analyze this impact, the projected 2040 Saturday AM and PM peak hour background traffic volumes were combined with volumes generated by the conceptual development for the Saturday AM and PM peak hours. Intersection LOS analyses were then performed and compared to the results of the background traffic volumes. This comparison shows the impact of the conceptual project in 2040.

### 9.2 Traffic Volumes

Project-generated traffic (**Figure 7**) was added to the future 2040 background volumes (**Figure 11**) to yield “future 2040 plus project” Saturday AM and PM peak hour traffic volumes at the study intersections as shown in **Figure 12**.

### 9.3 Level of Service Analysis

Using SimTraffic simulation software (for signalized and unsignalized intersections) and SIDRA software (for the roundabout) and the HCM 6 delay thresholds provided in the Introduction, future 2040 plus project Saturday AM and PM peak hour LOS were computed for each study intersection for the conceptual site development. The results of the analysis are reported in **Table 13** (see Appendix for the detailed LOS report).

**Table 13: Future 2040 plus Project Conditions Saturday AM & PM Peak Hour Level of Service**

Intersection				Worst Movement <sup>1</sup>			Overall Intersection <sup>2</sup>	
ID	Location	Period	Control	Movement <sup>3</sup>	Delay Sec/Veh	LOS	Avg. Delay Sec/Veh	LOS
1	Doe Pass Rd / Deer Valley Dr East	AM	Signal	-	-	-	2	A
		PM		-	-	-	2	A
2	Doe Pass Rd / Deer Valley Dr West	AM	SSSC <sup>4</sup>	NB Left	10	B	-	-
		PM		NB Left	16	C	-	-
3	Queen Esther Dr / Deer Valley Dr East	AM	SSSC	WB Left	7	A	-	-
		PM		WB Right	<b>&gt;300</b>	<b>F</b>	-	-
4	Deer Valley Dr East / Solamere Dr	AM	SSSC	SB Left	8	A	-	-
		PM		SB Left	<b>&gt;300</b>	<b>F</b>	-	-
5	Deer Valley Dr / Deer Valley Dr East / Deer Valley Dr West	AM	SSSC	WB Left	<b>33</b>	<b>D</b>	-	-
		PM		WB Right	<b>135</b>	<b>F</b>	-	-
6	Deer Valley Drive / Marsac Avenue	AM	Roundabout	-	-	-	20	C
		PM		-	-	-	11	B
7	Deer Valley Dr / Bonanza Dr	AM	Signal	-	-	-	15	B
		PM		-	-	-	<b>97</b>	<b>F</b>
8	Deer Valley Dr / Park Ave / Empire Ave	AM	Signal	-	-	-	<b>82</b>	<b>F</b>
		PM		-	-	-	<b>90</b>	<b>F</b>
9	Bonanza Dr / Monitor Dr / SR-248	AM	Signal	-	-	-	17	B
		PM		-	-	-	32	C

Notes:

**Bold text** indicates intersections operating below Park City's acceptable LOS threshold.

1. This represents the worst approach LOS and delay (seconds/vehicle) and is only reported for unsignalized intersections.
2. This represents the overall intersection LOS and delay (seconds/vehicle).
3. NB=Northbound, SB=Southbound, EB=Eastbound, WB=Westbound
4. Side-street stop control.

Source: Fehr & Peers.

As shown in **Table 13**, all study intersections operated within acceptable LOS (LOS C or better), with the exception of the following locations:

- Queen Esther Drive / Deer Valley Drive East: LOS F in the PM peak hour
  - This is caused by the vehicles attempting to turn left into Queen Esther Drive, trying to find a gap in the opposing traffic of vehicles exiting Deer Valley.
- Deer Valley Drive East / Solamere Drive: LOS F in the PM peak hour

- This is caused by the vehicles attempting to turn left into Solamere Drive, trying to find a gap in the opposing traffic of vehicles exiting Deer Valley.
- Deer Valley Drive East / Deer Valley Drive West: LOS D in the AM peak hour and LOS F in the PM peak hour
  - This is caused by the high volumes of vehicles exiting the Deer Valley Resort area making a westbound right turn onto Deer Valley Drive West. The westbound approach is stop-controlled, making it difficult for vehicles to find a gap and turn onto Deer Valley Drive West.
- Deer Valley Drive / Bonanza Drive: LOS F in the PM peak hour
  - This is caused by vehicle queues spilling back to this intersection from the upstream intersection at Deer Valley Drive / Park Avenue / Empire Avenue.
- Deer Valley Drive / Park Avenue / Empire Avenue: LOS F in both AM and PM peak hours
  - This is caused by congestion at the signal due to high volumes accessing various ski resorts and downtown Park City.

It should be noted that the proposed Snow Park Village development introduces various support land uses intended to attract resort users to stay on-site after the ski resort peak hour. This will help distribute the peaking of traffic, reducing delays at the study intersections and roadways. Therefore, the results shown in **Table 13** are likely overstated.

## 9.4 Mitigation Measures

The Snow Park Village site plan includes realignment of the Deer Valley Drive / Deer Valley Drive East / Deer Valley Drive West intersection. The intersection is currently a “T”-intersection with free-flow movement north/south along Deer Valley Drive West / Deer Valley Drive, and a stop-control on the approach of Deer Valley Drive East. The proposed plan adds a signal at the intersection, as shown in **Figure 8**. Deer Valley Drive West will serve as a primary transit and auto route to access the proposed transit hub and the main P2 parking level entrance on Doe Pass Road and serve private vehicles accessing Royal Street and the Trail’s End community. Deer Valley Drive East will serve as the secondary vehicular route to access the Snow Park drop-off/pick-up area and parking structure accesses that includes day skier spaces, hotel, and residences.

To account for this shift in traffic on Deer Valley Drives East and West stemming from intersection realignment, proposed wayfinding, and the placement of site access along Deer Valley Drive East, analyses presented in this report assume that roughly 40% of the total traffic would use Deer Valley Drive East and roughly 60% of the total traffic would use Deer Valley Drive West inbound in the AM peak hour, and roughly 80% of the traffic would use Deer Valley Drive East and roughly 20% of the traffic would use Deer Valley



Drive West outbound in the PM peak hour. This yields conservative results with regards to changes in travel behavior and will rely on various on- and off-site improvements to be realistically achieved. Background traffic was shifted and modified to account for the proposed shift in circulation.

Park City has a longstanding position of not mitigating certain deficient intersections within its boundaries due to the impacts of road widening and other potential mitigations to the community. As a result, potential mitigations at the intersections of Deer Valley Drive / Park Avenue / Empire Avenue, Bonanza Drive / Monitor Drive / SR-248 were not analyzed as part of this study and are therefore not included as recommendations. Further, deficiencies shown at the intersection of Deer Valley Drive / Bonanza Drive are not a result of project-generated trips or operations of the intersection itself; instead they stem from vehicle queues from the intersection of Deer Valley Drive / Park Avenue / Empire Avenue. As a result, mitigations at the intersection of Deer Valley Drive / Bonanza Drive are not recommended as part of this study. As stated earlier, Deer Valley Drive between the roundabout and SR-224 intersection is a UDOT facility. Any efforts to improve traffic will be led by UDOT.

The analysis results with the reconfigured Deer Valley Drive East / Deer Valley Drive West intersection are shown in **Table 14** (see Appendix for the detailed LOS report). As shown in **Table 14**, the Deer Valley Drive / Deer Valley Drive East / Deer Valley Drive West intersection operates at LOS B in the AM and PM peak hours.

With the redistributed traffic due to the proposed circulation, the Deer Valley Drive East / Solamere Drive and Deer Valley Drive East / Queen Esther Drive intersections experience increased delays. As a mitigation, the Snow Park Village site plan includes new left-turn pockets at both the Deer Valley Drive East / Solamere Drive and Deer Valley Drive East / Queen Esther Drive intersections to improve traffic operations during peak periods and better facilitate inbound left turns, as well as a receiving lane to allow for two-stage left turns out of Solamere Drive and Queen Esther Drive.

The Deer Valley Drive East / Solamere Drive intersection operates at LOS D as a side-street stop-controlled intersection and an additional turn lane and receiving lane, as mentioned above, which is considered unacceptable by Park City standards. A signal at this location will mitigate the intersection to a LOS A. It is recommended that the intersections at Deer Valley Drive East / Solamere Drive and Deer Valley Drive East / Queen Esther Drive be monitored and determine if further traffic control is needed when warranted to improve traffic flow and safety.



**Table 14: Future 2040 plus Project Mitigated Conditions Saturday AM & PM Peak Hour Level of Service**

Intersection				Worst Movement <sup>1</sup>			Overall Intersection <sup>2</sup>	
ID	Location	Period	Control	Movement <sup>3</sup>	Delay Sec/Veh	LOS	Avg. Delay Sec/Veh	LOS
1	Doe Pass Rd / Deer Valley Dr East	AM	Signal	-	-	-	4	A
		PM		-	-	-	7	A
2	Doe Pass Rd / Deer Valley Dr West	AM	SSSC <sup>4</sup>	NB Left	9	A	-	-
		PM		NB Left	6	A	-	-
3	Queen Esther Dr / Deer Valley Dr East	AM	SSSC	WB Left	8	A	-	-
		PM		WB Left	20	C	-	-
4	Deer Valley Dr East / Solamere Dr	AM	SSSC	SB Left	9	A	-	-
		PM		SB Left	<b>32</b>	<b>D<sup>4</sup></b>	-	-
5	Deer Valley Dr / Deer Valley Dr East / Deer Valley Dr West	AM	Signal	-	-	-	8	A
		PM		-	-	-	27	C
6	Deer Valley Drive / Marsac Avenue	AM	Roundabout	-	-	-	20	C
		PM		-	-	-	11	B
7	Deer Valley Dr / Bonanza Dr	AM	Signal	-	-	-	23	C
		PM		-	-	-	<b>67</b>	<b>E</b>
8	Deer Valley Dr / Park Ave / Empire Ave	AM	Signal	-	-	-	<b>83</b>	<b>F</b>
		PM		-	-	-	<b>91</b>	<b>F</b>
9	Bonanza Dr / Monitor Dr / SR-248	AM	Signal	-	-	-	15	B
		PM		-	-	-	31	C

Notes:

**Bold text** indicates intersections operating below Park City's acceptable LOS threshold.

1. This represents the worst approach LOS and delay (seconds/vehicle) and is only reported for unsignalized intersections.
2. This represents the overall intersection LOS and delay (seconds/vehicle).
3. NB=Northbound, SB=Southbound, EB=Eastbound, WB=Westbound
4. Solamere Drive performs at LOS D as a SSSC. Further analysis shows this intersection operates at LOS A as a signalized intersection, when warranted.

Source: Fehr & Peers.

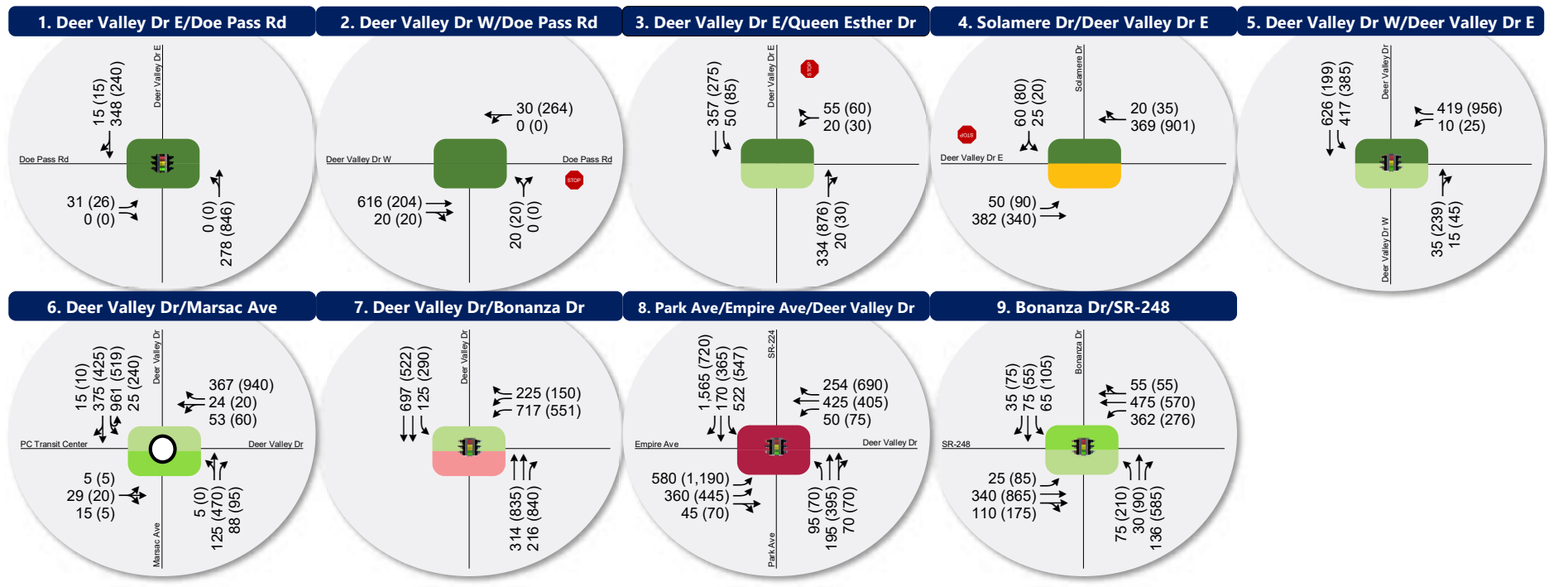

**LEGEND**

Stop Sign    
 Signalized    
 Roundabout

Lane Configuration:
   
 AM (PM)
   
 AM (PM)
   
 AM (PM)

} Peak Hour Traffic Volume per lane

Intersection Level of Service (LOS):

AM/PM    
 A    
 B    
 C    
 D    
 E    
 F

Figure 12  
 Future 2040 Plus Project Saturday AM & PM Peak Hour Traffic Conditions



# 10. Roadway Analysis

The purpose of the roadway analysis is to document the Saturday peak hour roadway volumes to determine the LOS of the internal project roadways.

## 10.1 Analysis Results

The roadway LOS was calculated based on planning level generalized peak hour two-way volumes for roadway capacities, as shown in **Table 15**. These volumes are published by the Florida Department of Transportation (FDOT) based on planning applications of the HCM and are widely used for planning level evaluation of roadway capacity. **Table 15** shows the peak hour two-way capacity estimates for a 2-lane roadway in areas over 5,000 population not in urbanized areas.

**Table 15: Roadway Level of Service Peak Hour Two-Way Traffic Thresholds**

Level of Service	Peak Hour Traffic Capacity Estimates
	2 Lanes
LOS B or better	≤ 820
LOS C	821 – 1,550
LOS D	1,551 – 2,190
LOS E or worse	> 2,190

Source: Fehr & Peers, based on FDOT Generalized Peak Hour Two-Way Volumes for areas over 5,000 not in urbanized areas.

As stated previously, the concept master plan for Snow Park Village shows Deer Valley Drive West as the primary inbound vehicular route, and Deer Valley Drive East as the primary outbound vehicular route. The same assumption used for previous analyses (40% of total traffic using Deer Valley Drive East and 60% of total traffic using Deer Valley Drive West for inbound AM peak, and 80% of total traffic using Deer Valley Drive East and 20% of total traffic using Deer Valley Drive West for outbound PM peak) were applied for the roadway volumes.

**Table 16** shows the peak hour roadway LOS analysis for each scenario. As shown in **Table 16**, all internal roadways are expected to operate at LOS C or better with the current 2-lane configuration for all scenarios.

**Table 16: Snow Park Village Roadway LOS Analysis Summary**

Scenario	Saturday Peak Hour	Deer Valley Dr W (South of Y-Intersection)		Deer Valley Dr E (East of Y-Intersection)	
		Two-Way Volume <sup>1</sup>	LOS	Two-Way Volume <sup>1</sup>	LOS
Existing	AM	650	A/B	400	A/B
	PM	800	A/B	620	A/B
Existing plus Project	AM	550	A/B	770	A/B
	PM	390	A/B	1,270	C
Opening Year 2024 plus Project	AM	600	A/B	740	A/B
	PM	400	A/B	1,280	C
Future 2040 plus Project	AM	690	A/B	870	C
	PM	510	A/B	1,420	C

1. Rounded up to the nearest 10.  
Source: Fehr & Peers.

Existing roadway count sheets are included in the Appendix.

# 11. Site Circulation Analysis

The January 2022 Transportation Analysis reported conditions at external intersections, as well as the two proposed intersections on Doe Pass Road at Deer Valley Drive East and Deer Valley Drive West, which were analyzed in SimTraffic simulation software and SIDRA software. Furthermore, microsimulation analysis was conducted to evaluate on-site circulation as part of the proposed Snow Park Village. Due to the limitations of SimTraffic software in evaluating multimodal conditions and garage access operations, VISSIM microsimulation software was used for on-site circulation analysis.

## 11.1.1 Conditions and Assumptions

The parameters described below were used for analysis as assumptions in the VISSIM model:

### 11.1.1.1 Volumes

The following high-level assumptions were used to assign volumes to individual driveways and approach routing:

- 2040 Peak-hour volumes as presented in Section 9 of this study
- Trip generation as presented in Section 4 of this study
- Assumed roughly 60%/40% split of traffic using Deer Valley Drive West versus Deer Valley Drive East inbound in the AM peak hour
- Assumed roughly 20%/80% split of traffic using Deer Valley Drive West versus Deer Valley Drive East outbound in the PM peak hour
- Proportion of parking supply by garage level

The assumed intersection and driveway volumes are shown in **Figure 13**. Note that the lane configurations shown on the figure reflect proposed conditions, except for at the P2 and P3 garage accesses, which are proposed to have flex lanes that can be ingress or egress, depending on the peak hour and volume demand.

### 11.1.1.2 Parking Garage Gate Transaction

Based on input received from WGI, the parking garage design and operations consultant, the following parking garage gate transaction times were assumed in the model:

- Average of 4 seconds/vehicle for entry
- Average of 10 seconds/vehicle for exit



### 11.1.1.3 Pick-up/Drop-off

The following assumptions were made for the model regarding the proposed new pick-up/drop-off loop in front of Snow Park Lodge at the southern terminus of Deer Valley Drive East:

- 200 vehicles were allocated to use the pick-up/drop-off in both AM and PM peak hours
  - 100 vehicles as pick-up/drop-off
  - 50 vehicles as Transportation Network Company (TNC) users
  - 50 vehicles as Valet users
- The dwell time for the pick-up/drop-off users were modeled ranging between 90 seconds and 180 seconds

### 11.1.1.4 Other Considerations

To evaluate conditions under the most conservative analysis scenario, 2040 weekend AM and PM peak hours were analyzed.

## 11.1.2 Analysis Results

Intersection delay, Level of Service (LOS), and queueing results were evaluated in the VISSIM model at the following locations, as shown in **Figure 13**.

1. Doe Pass Road / P2 Parking Garage Access
2. Doe Pass Road / P1 Parking Garage Access
3. Doe Pass Road / Mobility Hub Entrance
4. Doe Pass Road / Mobility Hub Exit
5. P2 Parking Garage Access / Deer Valley Drive East
6. P3 Parking Garage Access / Deer Valley Drive East
7. P4 Parking Garage Access / Deer Valley Drive East
8. Snow Park Lodge Pick-up/Drop-off

The same analysis methodology (as described in the previous sections) was used for this analysis.

**Table 17** below (see Appendix for the detailed LOS reports) shows the intersection delay and LOS results from the VISSIM simulation model. As shown in **Table 17**, all study intersections operate at acceptable LOS with the exception of the following locations:

- P4 Parking / Deer Valley Drive East: LOS D in the PM peak hour
  - This is caused by vehicles attempting to exit the garage for stop controlled movements onto a queue caused by the pick-up/drop-off area.

**Table 17: Future 2040 Plus Project Conditions Saturday AM & PM Peak Hour Level of Service Site Circulation Results**

Intersection				Worst Movement <sup>1</sup>			Overall Intersection <sup>2</sup>	
ID	Location	Period	Control	Movement <sup>3</sup>	Delay Sec/Veh	LOS	Avg. Delay Sec/Veh	LOS
1	Doe Pass Rd / P2 Parking	AM	SSSC	EB Right	16	C	-	-
		PM		NB Left	10	B	-	-
2	Doe Pass Rd / P1 Parking	AM	SSSC	NB Right	7	A	-	-
		PM		NB Right	7	A	-	-
3	Doe Pass Rd / Mobility Hub Entrance	AM	SSSC	WB Through	1	A	-	-
		PM		WB Through	1	A	-	-
4	Doe Pass Rd / Mobility Hub Exit	AM	SSSC	NB Left	11	B	-	-
		PM		NB Left	12	B	-	-
5	P2 Parking / Deer Valley Dr East	AM	SSSC	EB Left	8	A	-	-
		PM		EB Left	12	B	-	-
6	P3 Parking / Deer Valley Dr East	AM	SSSC	EB Left	10	B	-	-
		PM		EB Left	11	B	-	-
7	P4 Parking / Deer Valley Dr East	AM	SSSC	EB Left	17	C	-	-
		PM		EB Right	<b>34</b>	<b>D</b>	-	-
8	Snow Park Lodge Pick-up/Drop-off	AM	-	SB Through	13	B	-	-
		PM		SB Through	14	B	-	-

Notes:

**Bold text** indicates intersections operating below Park City's acceptable LOS threshold.

1. This represents the worst approach LOS and delay (seconds/vehicle) and is only reported for side-street stop controlled intersections.
2. This represents the overall intersection LOS and delay (seconds/vehicle) and is only reported for signalized intersections and all-way stop controlled intersections.
3. NB=Northbound, SB=Southbound, EB=Eastbound, WB=Westbound
4. Side-street stop control.

Source: Fehr & Peers.

### 11.1.2.1 Sensitivity Analysis

As described throughout this report, assumptions of traffic distribution at the Deer Valley Drive East / Deer Valley Drive West were made based on factors such as land use, pick-up/drop-off locations, as well as the quantity of parking accessible via driveways on Doe Pass Road and Deer Valley Drive East. It is likely that based on driver behavior and expectation, the actual traffic distributions will be different at the time of opening and in subsequent weeks, months, and years as preferences are established and transportation options evolve.



A sensitivity analysis shows that in the AM peak hour, the P2 access on Doe Pass Road becomes a constraint that potentially causes congestion, with inbound queues backing up onto Deer Valley Drive West under traffic conditions similar to the existing conditions (roughly 80% entering via Deer Valley Drive West). Operations at this key driveway also depend on the transaction time for entry (assumed to be 4 seconds for the purpose of microsimulation analysis in this report, which was validated by a national parking operations consultant). As this entry transaction time is reduced due to improved technology or adjustments to when and how parking is paid for and validated, traffic distributions at the “Y” intersection have less affect on traffic operations.

In the PM peak hour, a sensitivity analysis shows that the “Y” intersection is less sensitive to different traffic splits. The assumption of outbound traffic being assigned at 80% Deer Valley Drive East and 20% Deer Valley Drive West is due to the location of most parking exits on Deer Valley Drive East and discouragement of cut-through traffic on Doe Pass Road that presents conflicts between vehicles and buses using the proposed mobility hub. A sensitivity analysis revealed that shifting outbound traffic 40% using Deer Valley Drive West and 60% Deer Valley Drive East, very similar to existing traffic patterns, still leads to the Y functioning at acceptable levels of service.

To provide efficient and safe traffic circulation on-site and on the Deer Valley Drive Loop, Deer Valley and Snow Park Village will be committed to provide extensive wayfinding and traffic monitoring, especially to improve inbound operations where visitors will be informed whether to travel on Deer Valley Drive West or Deer Valley Drive East.

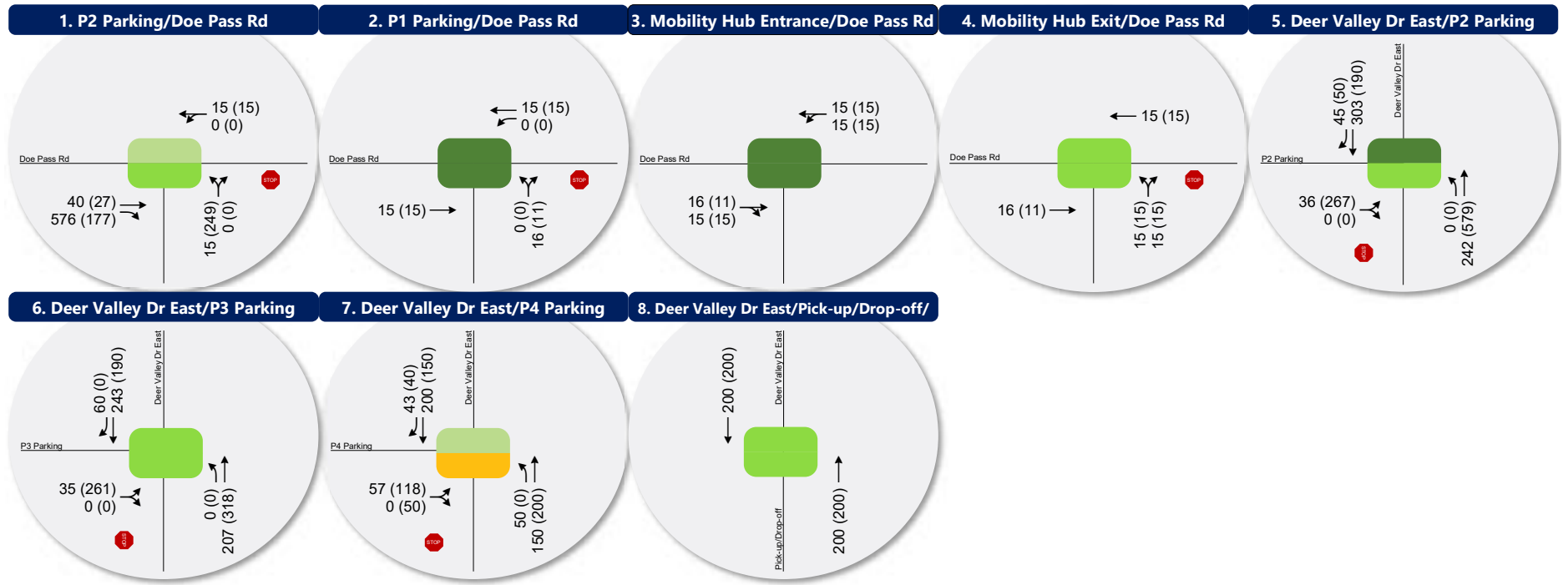

**LEGEND**

Stop Sign    
 Signalized    
 Roundabout

Lane Configuration:
 

- ← AM (PM)
- ← AM (PM)
- ← AM (PM)

 Peak Hour Traffic Volume per lane

Intersection Level of Service (LOS):

A
B
C
D
E
F

Figure 13  
2040 Site Circulation Analysis Intersection LOS Results





**Table 18** (see Appendix for the detailed queue report) below shows the average maximum queue for each approach at the study intersections. The following lists locations that the average maximum queue is expected to exceed the storage length in the AM peak hour:

- Doe Pass Road / P2 Parking
  - Eastbound queues occasionally extend past the Doe Pass Road / Deer Valley Drive West intersection. This queue is caused by queue spillback beginning at the gate to enter the P2 Parking Garage Access and the high inbound volumes in the AM peak hour.
- Doe Pass Road / Mobility Hub Entrance
  - Westbound queues occasionally extend past the mobility hub exit. The average queue, however, is less than 30 feet, and the queue spillback is not expected to be a common occurrence.

The following lists locations that the average maximum queue is expected to exceed the storage length in the PM peak hour:

- Doe Pass Road / Deer Valley Drive East
  - Northbound queues occasionally extend past the P2 Parking Garage Access. The average queue, however, is 96 feet, and the queue spillback is not expected to be a common occurrence.
- Doe Pass Road / Mobility Hub Entrance
  - Westbound queues occasionally extend past the mobility hub exit. The average queue, however, is less than 30 feet, and the queue spillback is not expected to be a common occurrence.
- Deer Valley Drive East / Pick-up and Drop-off
  - Southbound queues occasionally extend past the P4 Parking Garage Access. This is caused by queues due to inefficient pick-up/drop-off that the VISSIM simulation has limitations in. This can likely be mitigated by efficient operations assisted by Deer Valley staff.
- Deer Valley Drive East / Deer Valley Drive West
  - The simulation shows average maximum queues of over 800 feet for the westbound approach at the new signal. This queue however is not expected to reach the Solamere Drive intersection, especially with signal operations to assist in flushing out the heavy outbound movement via Deer Valley Drive East.



**Table 18: Future 2040 Plus Project Conditions Saturday AM & PM Peak Hour Queues Site Circulation Analysis**

Intersection				Average Maximum Queues (feet) <sup>2</sup>
ID	Location	Period	Approach <sup>1</sup>	
1	Doe Pass Rd / Deer Valley Dr East	AM	NB	175
			SB	250
			EB	50
		PM	NB	400
			SB	200
			EB	50
2	Doe Pass Rd / Deer Valley Dr West	AM	NB	50
			EB	325
			WB	0
		PM	NB	50
			EB	25
			WB	0
3	Queen Esther Dr / Deer Valley Dr East	AM	NB	0
			SB	50
			WB	75
		PM	NB	25
			SB	100
			WB	75
4	Deer Valley Dr East / Solamere Dr	AM	SB	75
			EB	50
			WB	0
		PM	SB	75
			EB	100
			WB	25
5	Deer Valley Dr East / Deer Valley Dr West	AM	NB	100
			SB	275
			WB	175
		PM	NB	300
			SB	275
			WB	850
6	Doe Pass Rd / P2 Parking	AM	NB	50
			EB	225
			WB	0



Intersection				Average Maximum Queues (feet) <sup>2</sup>
ID	Location	Period	Approach <sup>1</sup>	
7	Doe Pass Rd / P1 Parking	PM	NB	125
			EB	25
			WB	0
		AM	NB	75
			EB	0
			WB	0
PM	NB	75		
	EB	0		
	WB	0		
8	Doe Pass Rd / Mobility Hub Entrance	AM	EB	0
			WB	125
		PM	EB	0
			WB	125
9	Doe Pass Rd / Mobility Hub Exit	AM	NB	175
			EB	0
			WB	25
		PM	NB	175
			EB	0
			WB	25
10	P2 Parking / Deer Valley Dr East	AM	NB	0
			SB	0
			EB	125
		PM	NB	150
			SB	0
			EB	125
11	P3 Parking / Deer Valley Dr East	AM	NB	100
			SB	125
			EB	100
		PM	NB	125
			SB	100
			EB	100
12	P4 Parking / Deer Valley Dr East	AM	NB	25
			SB	25
			EB	100
		PM	NB	0

Intersection				Average Maximum Queues (feet) <sup>2</sup>
ID	Location	Period	Approach <sup>1</sup>	
13	Snow Park Lodge Pick-up/Drop-off		SB	25
			EB	175
		AM	NB	25
			SB	125
		PM	NB	50
			SB	200

Notes:

1. NB=Northbound, SB=Southbound, EB=Eastbound, WB=Westbound
2. Rounded up to nearest 25'.

Source: Fehr & Peers.

It should be noted that the LOS results and queue results shown in **Table 17** and **Table 18** capture the delays and queues at the side-streets for vehicles turning onto the major road. However, it does not capture the delays and queues for vehicles experienced at the parking gate due to the assumed transaction time. The VISSIM simulation indicates that with the assumed gate transaction times, vehicles are expected to experience over 100 seconds of delay per vehicle to exit the garage in the PM peak hour, with potentially long internal queues.



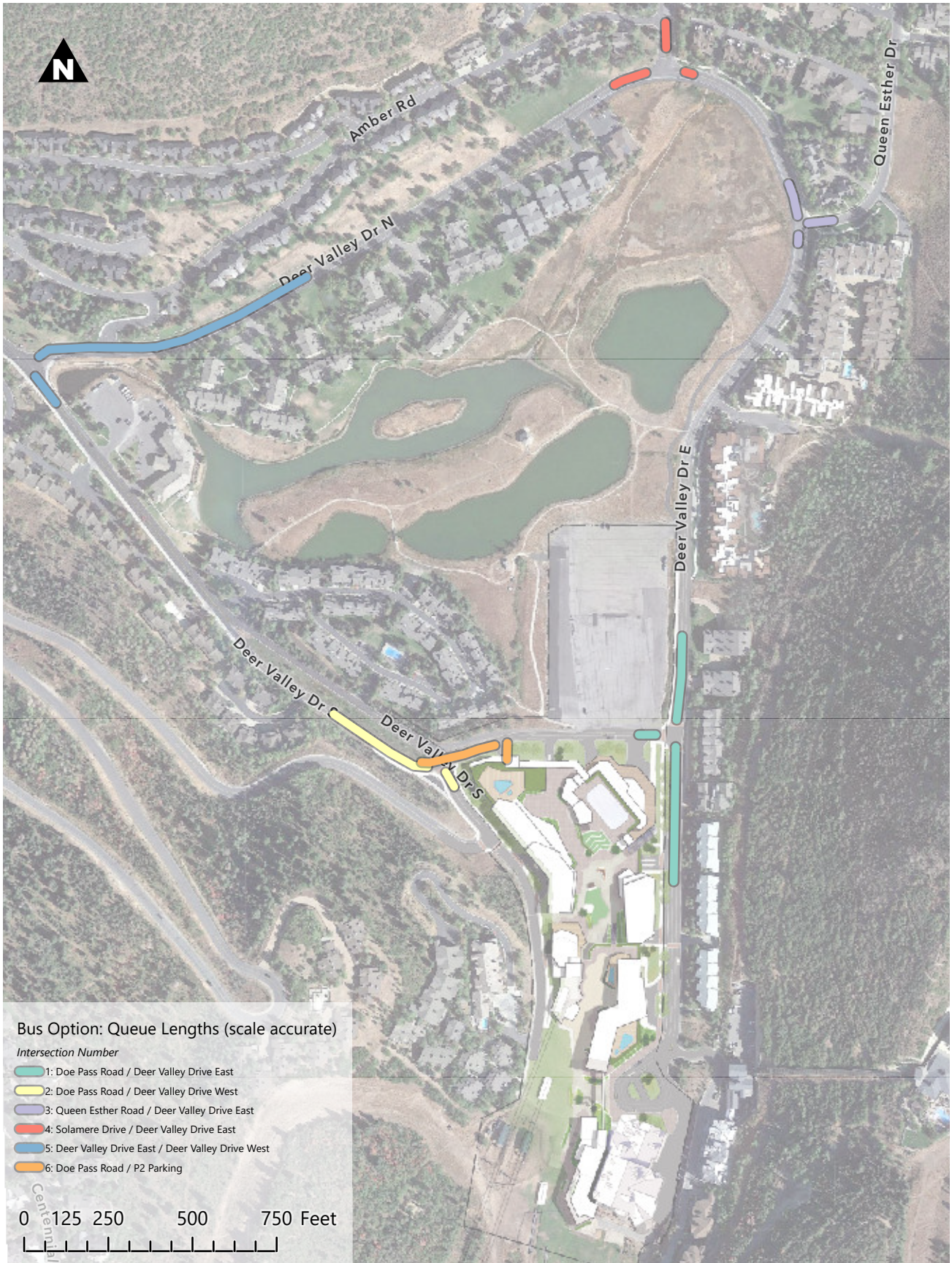

Figure 14  
 2040 Site Circulation Analysis Queue Results: Bus Option 

## 12. Parking Analysis

A fundamental aspect of the Snow Park Village proposal is the implementation of a constrained, structured parking supply that will require parkers to pay a daily fee. This strategy is seen as a key disincentive to traveling in Park City by single-occupant vehicle, and aligns with the City's broader mobility goals.

### 12.1 Analysis Method

For the shared parking analysis of the updated land use plan, the development is proposed to include 11 buildings which include the following land uses (taken from the land use program dated October 26, 2021):

- 30,900 square feet of ballroom/event center space
- 143 multifamily housing units
- 193 hotel rooms with 4,500 square feet of hotel support uses.
- 25,900 square feet of commercial/retail space

The development is also proposed to include the Deer Valley Ski resort and other land uses in support of the resort. It should be noted that the land uses supporting the ski resort will not be parking generators; rather, the ski resort will be the parking generator, and the support land uses serve as accessories to the resort.

Fehr & Peers applied the methodology outlined in Urban Land Institute's (ULI) *Shared Parking Manual, 3<sup>rd</sup> Edition* and its associated spreadsheet tool, to determine the recommended number of parking spaces at Snow Park Village. The methods outlined in *Shared Parking* are considered national state-of-the-practice for right-sizing parking supplies to be shared by multiple land uses. It provides instruction for reducing parking requirements for mixed use developments.

The ULI manual includes baseline parking rates that are informed by parking counts performed across the United States. While these are generally acceptable in many land use contexts, the baseline ULI parking rates are based on nationwide suburban area parking counts and do not consider the unique travel patterns in the study area, nor the atypical land use context (adjacent to a destination ski resort). Therefore, this analysis was performed using parking rates based on the parking requirements outlined in Park City zoning code.

Fehr & Peers estimated the required number of parking spaces at the development using the following factors:





- Proposed land use characteristics as described in the introduction
- Recommended parking rates from IBI Group which are comparable to Park City Zoning Code minima
- Monthly adjustment factors from *Shared Parking*
- Time-of-day adjustment factors from *Shared Parking*
- Noncaptive ratios (internal capture) rates calculated using ULI's *Shared Parking* spreadsheet tool
- Mode adjustment (walking, biking, transit) rates calculated using ULI's *Shared Parking* spreadsheet tool
- Parking counts at the resort collected during ski season from 2015-2016, 2016-2017, 2018-2019, and 2019-2020
  - These counts showed an average February Saturday parking rate of 1,433 stalls at the resort. This was rounded up to assume 1,500 stalls for day skiers and employees

From the proposed land uses that generate parking demand, and the recommended rates from the Park City zoning code, the minimum required parking supply was calculated to be 2,236 stalls. This however does not account for paid parking (which is proposed in future plans for the parking structure) and shared parking among uses. For the shared parking analysis, a reduction of up to 9% was calculated due to the factors listed above, resulting in a parking supply of 2,041 stalls based on shared parking reductions alone.

A reduction of up to 17% in daily parking demand due to paid parking was calculated using methods derived from *The Price Elasticity of Parking: a Meta-Analysis* (Lehner, Peer; 2018), which evaluates price sensitivities to the implementation of paid parking from 50 separate studies. Given that many Deer Valley guests are likely to be less price sensitive than the general public, this study assumes less reduction in demand due to paid parking. It is worth noting, however, that many day skiers visiting from points along the Wasatch Front are more likely to be influenced by the implementation from paid parking.

This results in a potential reduction of up to 26% in recommended parking due to paid parking and shared parking. For this study, to present a more conservative reduction and resulting parking supply, a 20% reduction was assumed to be applicable due to factors such as existing and proposed land uses and expected growth, and was applied to the base required parking. **Table 19** outlines the number of recommended stalls with the reduction due to paid parking and shared parking. Shared parking calculations are attached in the Appendix.

**Table 19: Snow Park Village Parking Analysis Summary**

Base Recommended Stalls	% Reduction (Paid Parking and Shared Parking)	Stalls Reduced (Paid Parking and Shared Parking)	Net Recommended Stalls
2,236	20%	447	<b>1,789</b>

Source: Fehr & Peers



As shown in **Table 19**, with the expected reductions due to paid parking and shared parking, it is recommended that a minimum of 1,789 stalls be provided for the proposed Snow Park Village development. Snow Park Village will provide 1,810 parking stalls, slightly exceeding the minimum recommended supply of parking but also reducing parking supply from what would typically be required by Park City code. It should be noted that phasing and ongoing refinement of the land use program may adjust the base parking rates and recommendations.

## 12.2 Parking Management

An effective and efficient parking management system is essential to maintain both a high-quality user experience and to minimize traffic impacts on adjacent roadways. An essential element to improve the efficiency of structured parking is to provide real time information regarding parking availability. In addition to implementing payment technology that expedites vehicle ingress at all driveways, Deer Valley will work with relevant partners to ensure more complete information is available to parkers.

The Snow Park Parking Management Plan is included in **Attachment B**.

## 13. Transit Evaluation

This section includes an evaluation of existing transit service and infrastructure, proposed transit improvements, and description of how the Snow Park Village proposal aligns with Park City's *Transit First* policy.

### 13.1.1 Existing Transit Service

In addition to a multitude of private shuttles and buses, there are two public transit operators providing transit service to and from Deer Valley: Park City Transit and High-Valley Transit. High Valley Transit operates one route that services Deer Valley:

- 101 – Spiro / 224 Local that services Deer Valley.

Park City Transit operates six routes the service Deer Valley:

- 1 Red: Prospector Square – Deer Valley
- 2 Green: Park Meadows/Thaynes Canyon – Deer Valley
- 3 Blue: Thaynes Canyon/Park Meadows – Deer Valley
- 5 Yellow: Prospector Square – Deer Valley
- 40 Bronze: Main Street – Royal Street – Silver Lake Lodge
- 50 Teal: Prospector Square – Deer Valley

Park City Transit Park City Transit is undergoing a short-range service plan update, with potential changes in transit service to and from Deer Valley expected in the coming year.

Local bus stops are provided along both sides of Deer Valley Drive East and Deer Valley Drive West, allowing transit riders to board buses that are Deer Valley- or Old Town-bound. At the southern end of the Deer Valley Drive loop closest to the existing Snow Park base area, there are bi-directional bus stops that can accommodate up to four buses at once. Aside from the existing bi-directional stops at Snow Park, bus stops do not include shelters. Buses providing service to Deer Valley travel in mixed traffic.

## 13.2 Proposed Transit Improvements

A proposed six bus-bay mobility hub at the northeast corner of Snow Park Village will provide a comfortable and appealing transit facility on-site that provides direct access to the project and relocated ski lift bases. The mobility hub will also include accommodations for cyclists and allow for electric bus charging



infrastructure. This mobility hub will allow for increased frequency of transit service which will be essential to incentivizing transit service.

To further support transit service as part of the Snow Park Village proposal, a new traffic signal with transit preemption capabilities is proposed at the Doe Pass Road / Deer Valley Drive East intersection. This will help ensure that transit vehicles accessing and exiting the proposed mobility hub with limited conflicting traffic.

Furthermore, this circulation plan for the transit priority alternative includes a proposed seasonal one-way transit lane inbound from the Deer Valley Drive East / Deer Valley Drive West intersection along Deer Valley Drive West, accessing the mobility hub. Outbound transit traffic will have a flex transit lane which parallels general purpose traffic around the loop on Deer Valley Drive East to the Deer Valley Drive East / Deer Valley Drive West intersection. After ski season during the summer months, the flex transit lane will be open to bicycle traffic. Management, maintenance, and enforcement, year-round, will be a City responsibility.

The VISSIM simulation presented previously in chapter 11 simulates the transit lane and captures the impacts of the design. The simulation shows traffic circulation with minimal delays with the proposed configuration in peak ski season conditions. Because of the lack of congestion, the buses simulated in both this *Transit Priority Alternative* and the *Bike Priority Alternative* travel in near free-flow conditions. Therefore, no differences in bus travel time were observed through the simulation model between the two alternatives. However, the transit lane proposed in this alternative will likely improve bus travel times in more congested conditions, such as special events, snow conditions, etc.

# 14. Transportation Demand Management

Park City, through its ongoing Transportation Master Plan update, has identified the laudable and ambitious goal of reducing vehicle trips by 20% throughout Park City. The City is tackling this challenge through a variety of strategies, including but not limited to the following:

- Updates to the local and regional transit system
- Coordination with partner agencies to implement greater park-and-ride capacity
- Expansion of high-quality active transportation facilities throughout Park City
- Partnerships with private developments to implement and operate comprehensive Transportation Demand Management (TDM) programs

Furthering the City’s broader trip reduction goal, Deer Valley will continue to operate its TDM program, and expand on current offerings, to better align with the adopted PCMC TDM Plan (2016). A high-level summary of the Deer Valley TDM Plan is shown below in **Table 20**.

**Table 20: Deer Valley TDM Measures**

Measure	Status	Description
Transit pass subsidy	Existing Program	Subsidized UTA transit passes for Deer Valley employees living in Salt Lake Valley and Utah Valley
Bicycle Amenities and Perks	New Program	Bicycle repair tools and dedicated bicycle parking at key locations
Education and Promotion	Existing Program	Educational and promotional events to encourage travelers to use by modes other than driving alone.
Parking Management	New Program	Efficient, constrained, and priced parking to discourage drive-alone trips
Employee Transit	Existing Program	Operate designated employee transit to facilitate efficient employee commutes through an appealing alternative until such time as Park City Transit and/or High Valley Transit meets this need
Real-Time Messaging	New Program	Communicate traffic conditions in real time to travelers
Appoint a TDM Coordinator	New Program	Identify a staff member to oversee the TDM program

Source: Fehr & Peers.



## 14.1 TDM Monitoring

As the transportation landscape in Park City and Summit County changes, monitoring the use and effectiveness of Deer Valley’s TDM program will be crucial to its success. In alignment with requests from Park City staff, Deer Valley will implement an annual monitoring program consisting of the following elements:

- One nine day period of vehicle counts at all Snow Park Village driveways, to be analyzed and summarized by a third-party consultant. This data will be analyzed and summarized by a third-party consultant;
- Average vehicle occupancy collected on one weekday and one weekend day, collected by a third-party vendor, to be analyzed and summarized by a third-party consultant;
- A permanent traffic count station implemented at the Deer Valley Drive / Deer Valley Drive East / Deer Valley Drive West intersection, installed and maintained by Deer Valley for year-round monitoring of traffic conditions;
- Ski season transit ridership, summarized at the stop and daily levels and provided by transit operators, to be analyzed and summarized by a third-party consultant;
- Available data regarding program utilization from the *Ride On Park City* platform, to be analyzed and summarized by a third-party consultant.

Analysis of this data will be submitted in an annual monitoring memorandum for City staff review and will be supported by semiannual coordination meetings with City staff and other major employers in Park City. This monitoring program will be used to enhance program offerings and avoid redundancy of service where public and private options overlap.

## 14.2 Regional Considerations

Park City Municipal Corporation has a stated goal of reducing traffic volumes by 20% from existing traffic volumes (the specific, reference time period is to-be-defined). Deer Valley has operated an effective and comprehensive TDM program for years in support of this goal, and the proposed opening of an additional portal to Deer Valley via Mayflower Resort will improve access to Deer Valley to any skiers visiting from the Wasatch Front or Back and not require a trip through Park City. While this change will not solve all of Park City’s traffic challenges, it will likely divert a substantial portion of traffic destined for Deer Valley.

The Deer Valley TDM Plan is presented in full in **Attachment C**.



## 15. Conclusion/Recommendations

With proposed mitigations in place, all study intersections at which mitigations are feasible and supported by the community operate at acceptable levels of service under all Plus Project analysis scenarios. Through dedicated transit infrastructure, improved active transportation connections between the Project and Park City’s existing active transportation network, a fully reworked parking system, and management of ongoing TDM offerings in addition to new measures, the Snow Park Village proposal aligns with the City’s *Transit First* policy by encouraging travel by means other than driving alone.

Implementing a new traffic signal with transit preemption at the intersection of Doe Pass Road / Deer Valley Drive East will improve traffic operations and support transit. A new traffic signal at the reconfigured Y intersection of Deer Valley Drive / Deer Valley Drive East / Deer Valley Drive West facilitates safer and more efficient movement for all modes. Implementing an off-street, multi-use path around the Deer Valley Drive loop will improve pedestrian and cyclist connectivity adjacent to the project site. Ongoing monitoring of TDM program effectiveness will maintain City-Deer Valley cooperation in pursuit of shared goals.



# Appendix

# L2 Data Collection

L2DataCollection.com  
Idaho (208) 860-7554 Utah (801) 413-2993

Study: FEHR0119  
Intersection: Deer Valley/ Deer Valley N  
City, State: Deer Valley, Utah  
Control: Stop Sign

File Name : Deer Valley Dr & Deer Valley Dr N - D1  
Site Code : Day 1  
Start Date : 2/15/2020  
Page No : 1

### Groups Printed- General Traffic

Start Time	Deer Valley Drive From Northwest				Deer Valley Drive N From East				Deer Valley Drive From Southeast				Int. Total
	Thru	Bear Left	Peds	App. Total	Bear Right	Hard Left	Peds	App. Total	Hard Right	Thru	Peds	App. Total	
07:45 AM	71	123	0	194	19	4	0	23	2	18	0	20	237
Total	71	123	0	194	19	4	0	23	2	18	0	20	237
08:00 AM	110	101	0	211	34	2	0	36	5	21	1	27	274
08:15 AM	124	70	0	194	29	2	0	31	5	26	0	31	256
08:30 AM	117	55	0	172	53	10	0	63	4	29	0	33	268
08:45 AM	125	46	0	171	48	7	0	55	6	32	4	42	268
Total	476	272	0	748	164	21	0	185	20	108	5	133	1066
09:00 AM	111	35	0	146	54	7	0	61	2	31	0	33	240
09:15 AM	94	27	0	121	51	6	0	57	4	31	0	35	213
09:30 AM	77	42	0	119	55	13	0	68	4	43	0	47	234
-----													
Total	282	104	0	386	160	26	0	186	10	105	0	115	687
-----													
03:30 PM	81	47	0	128	67	4	0	71	13	69	0	82	281
03:45 PM	55	50	0	105	81	7	0	88	16	98	3	117	310
Total	136	97	0	233	148	11	0	159	29	167	3	199	591
04:00 PM	66	41	0	107	83	8	0	91	11	130	0	141	339
04:15 PM	46	49	6	101	73	3	0	76	18	155	0	173	350
04:30 PM	46	68	0	114	104	2	0	106	13	109	1	123	343
04:45 PM	54	58	0	112	71	5	0	76	13	91	2	106	294
Total	212	216	6	434	331	18	0	349	55	485	3	543	1326
05:00 PM	42	51	0	93	89	2	0	91	11	95	4	110	294
05:15 PM	30	55	0	85	63	4	0	67	9	78	0	87	239
Grand Total	1249	918	6	2173	974	86	0	1060	136	1056	15	1207	4440
Apprch %	57.5	42.2	0.3		91.9	8.1	0		11.3	87.5	1.2		
Total %	28.1	20.7	0.1	48.9	21.9	1.9	0	23.9	3.1	23.8	0.3	27.2	

# L2 Data Collection

L2DataCollection.com  
 Idaho (208) 860-7554 Utah (801) 413-2993

Study: FEHR0119  
 Intersection: Deer Valley/ Deer Valley N  
 City, State: Deer Valley, Utah  
 Control: Stop Sign

File Name : Deer Valley Dr & Deer Valley Dr N - D1  
 Site Code : Day 1  
 Start Date : 2/15/2020  
 Page No : 2

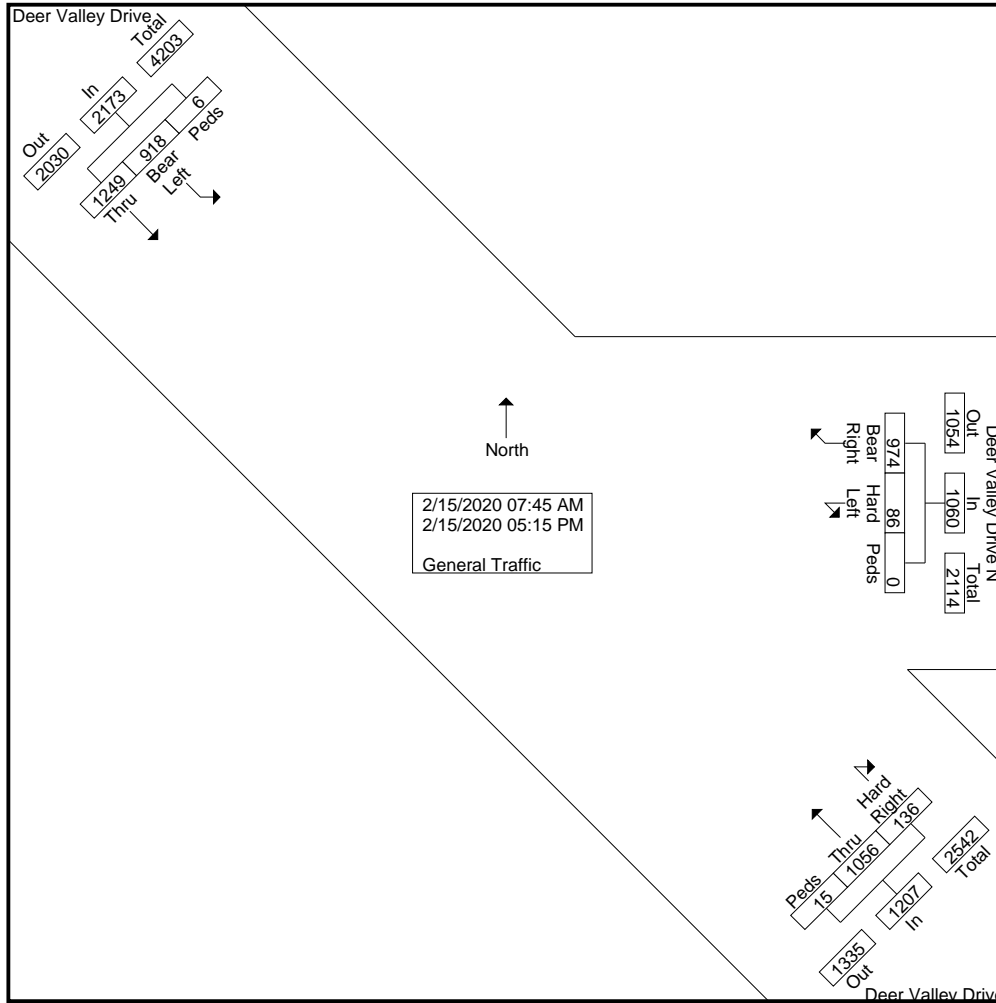



# L2 Data Collection

L2DataCollection.com  
 Idaho (208) 860-7554 Utah (801) 413-2993

Study: FEHR0119  
 Intersection: Deer Valley/ Deer Valley N  
 City, State: Deer Valley, Utah  
 Control: Stop Sign

File Name : Deer Valley Dr & Deer Valley Dr N - D1  
 Site Code : Day 1  
 Start Date : 2/15/2020  
 Page No : 3

Start Time	Deer Valley Drive From Northwest				Deer Valley Drive N From East				Deer Valley Drive From Southeast				Int. Total
	Thru	Bear Left	Peds	App. Total	Bear Right	Hard Left	Peds	App. Total	Hard Right	Thru	Peds	App. Total	
<b>Peak Hour Analysis From 07:45 AM to 11:45 AM - Peak 1 of 1</b>													
Peak Hour for Entire Intersection Begins at 08:00 AM													
08:00 AM	110	101	0	211	34	2	0	36	5	21	1	27	274
08:15 AM	124	70	0	194	29	2	0	31	5	26	0	31	256
08:30 AM	117	55	0	172	53	10	0	63	4	29	0	33	268
08:45 AM	125	46	0	171	48	7	0	55	6	32	4	42	268
Total Volume	476	272	0	748	164	21	0	185	20	108	5	133	1066
% App. Total	63.6	36.4	0		88.6	11.4	0		15	81.2	3.8		
PHF	.952	.673	.000	.886	.774	.525	.000	.734	.833	.844	.313	.792	.973

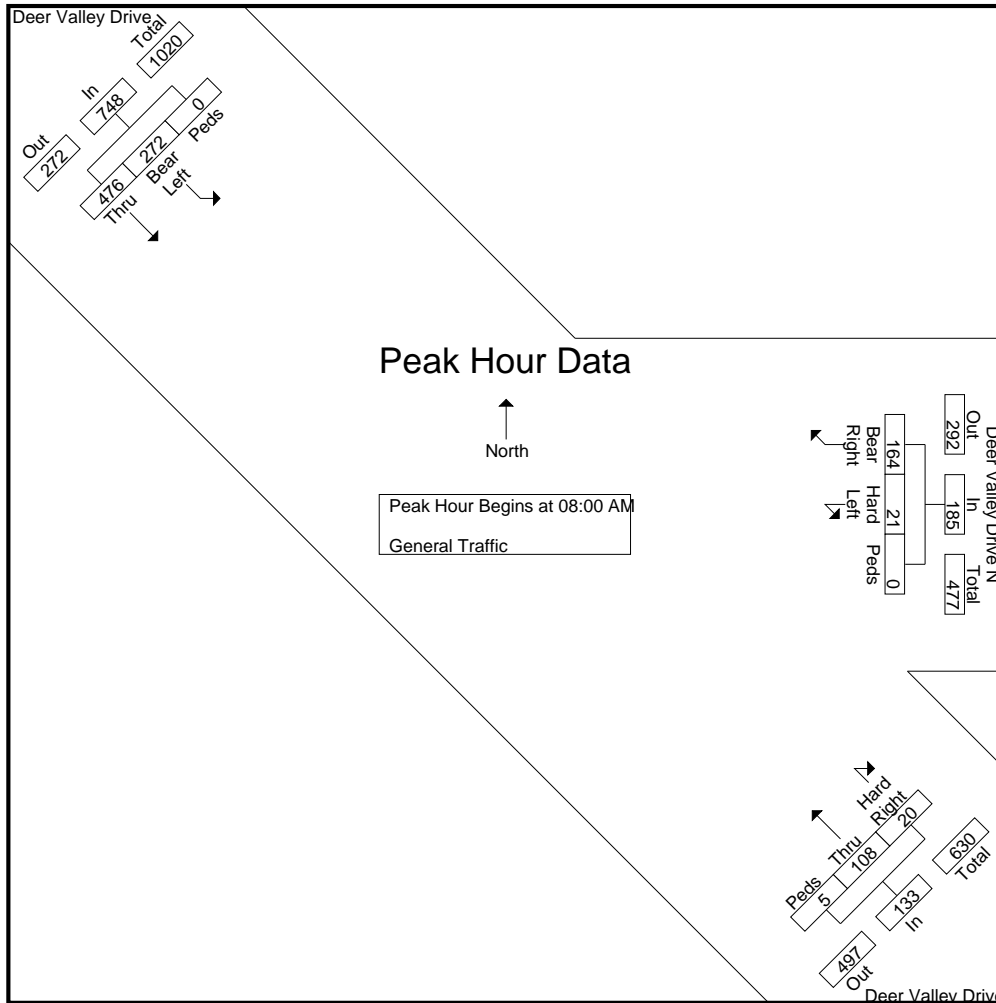

# L2 Data Collection

L2DataCollection.com  
 Idaho (208) 860-7554 Utah (801) 413-2993

Study: FEHR0119  
 Intersection: Deer Valley/ Deer Valley N  
 City, State: Deer Valley, Utah  
 Control: Stop Sign

File Name : Deer Valley Dr & Deer Valley Dr N - D1  
 Site Code : Day 1  
 Start Date : 2/15/2020  
 Page No : 4

Start Time	Deer Valley Drive From Northwest				Deer Valley Drive N From East				Deer Valley Drive From Southeast				Int. Total
	Thru	Bear Left	Peds	App. Total	Bear Right	Hard Left	Peds	App. Total	Hard Right	Thru	Peds	App. Total	

**Peak Hour Analysis From 07:45 AM to 11:45 AM - Peak 1 of 1**

Peak Hour for Each Approach Begins at:

	07:45 AM				08:45 AM				08:45 AM			
+0 mins.	71	123	0	194	48	7	0	55	6	32	4	42
+15 mins.	110	101	0	211	54	7	0	61	2	31	0	33
+30 mins.	124	70	0	194	51	6	0	57	4	31	0	35
+45 mins.	117	55	0	172	55	13	0	68	4	43	0	47
Total Volume	422	349	0	771	208	33	0	241	16	137	4	157
% App. Total	54.7	45.3	0		86.3	13.7	0		10.2	87.3	2.5	
PHF	.851	.709	.000	.914	.945	.635	.000	.886	.667	.797	.250	.835

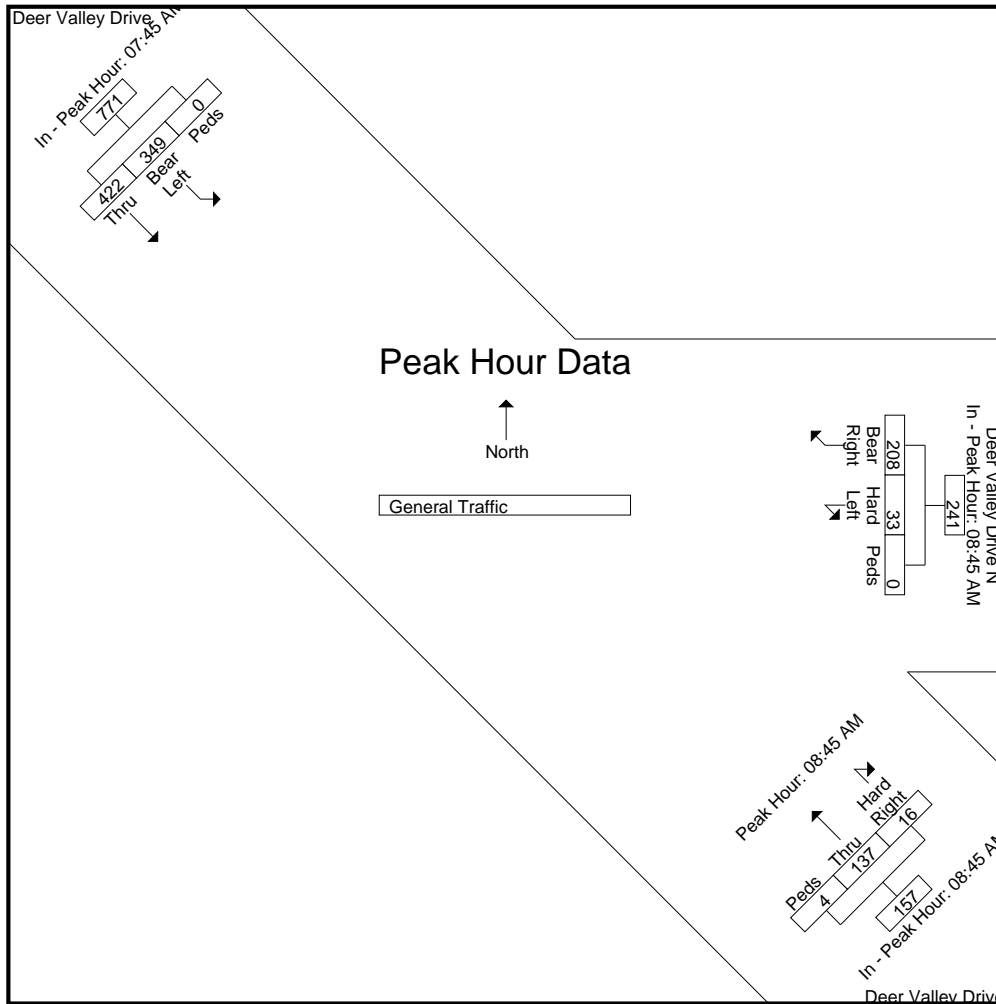

# L2 Data Collection

L2DataCollection.com  
Idaho (208) 860-7554 Utah (801) 413-2993

Study: FEHR0119  
Intersection: Deer Valley/ Deer Valley N  
City, State: Deer Valley, Utah  
Control: Stop Sign

File Name : Deer Valley Dr & Deer Valley Dr N - D1  
Site Code : Day 1  
Start Date : 2/15/2020  
Page No : 5

Start Time	Deer Valley Drive From Northwest				Deer Valley Drive N From East				Deer Valley Drive From Southeast				Int. Total
	Thru	Bear Left	Peds	App. Total	Bear Right	Hard Left	Peds	App. Total	Hard Right	Thru	Peds	App. Total	
<b>Peak Hour Analysis From 12:00 PM to 05:15 PM - Peak 1 of 1</b>													
Peak Hour for Entire Intersection Begins at 03:45 PM													
03:45 PM	55	50	0	105	81	7	0	88	16	98	3	117	310
04:00 PM	66	41	0	107	83	8	0	91	11	130	0	141	339
04:15 PM	46	49	6	101	73	3	0	76	18	155	0	173	350
04:30 PM	46	68	0	114	104	2	0	106	13	109	1	123	343
Total Volume	213	208	6	427	341	20	0	361	58	492	4	554	1342
% App. Total	49.9	48.7	1.4		94.5	5.5	0		10.5	88.8	0.7		
PHF	.807	.765	.250	.936	.820	.625	.000	.851	.806	.794	.333	.801	.959

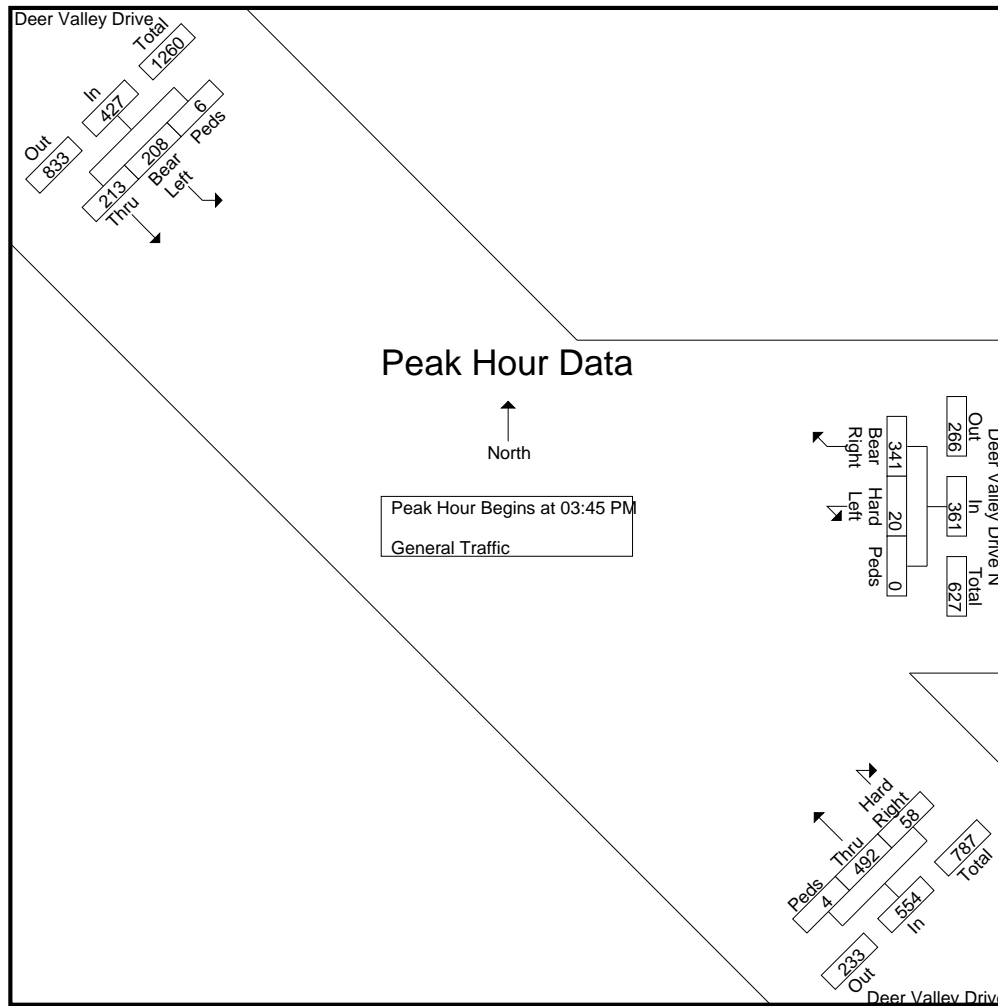

# L2 Data Collection

L2DataCollection.com  
 Idaho (208) 860-7554 Utah (801) 413-2993

Study: FEHR0119  
 Intersection: Deer Valley/ Deer Valley N  
 City, State: Deer Valley, Utah  
 Control: Stop Sign

File Name : Deer Valley Dr & Deer Valley Dr N - D1  
 Site Code : Day 1  
 Start Date : 2/15/2020  
 Page No : 6

Start Time	Deer Valley Drive From Northwest				Deer Valley Drive N From East				Deer Valley Drive From Southeast				Int. Total
	Thru	Bear Left	Peds	App. Total	Bear Right	Hard Left	Peds	App. Total	Hard Right	Thru	Peds	App. Total	

**Peak Hour Analysis From 12:00 PM to 05:15 PM - Peak 1 of 1**

Peak Hour for Each Approach Begins at:

	03:30 PM				03:45 PM				03:45 PM			
+0 mins.	<b>81</b>	47	0	<b>128</b>	81	7	0	88	16	98	<b>3</b>	117
+15 mins.	55	<b>50</b>	0	105	83	<b>8</b>	0	91	11	130	0	141
+30 mins.	66	41	0	107	73	3	0	76	<b>18</b>	<b>155</b>	0	<b>173</b>
+45 mins.	46	49	<b>6</b>	101	<b>104</b>	2	0	<b>106</b>	13	109	1	123
Total Volume	248	187	6	441	341	20	0	361	58	492	4	554
% App. Total	56.2	42.4	1.4		94.5	5.5	0		10.5	88.8	0.7	
PHF	.765	.935	.250	.861	.820	.625	.000	.851	.806	.794	.333	.801

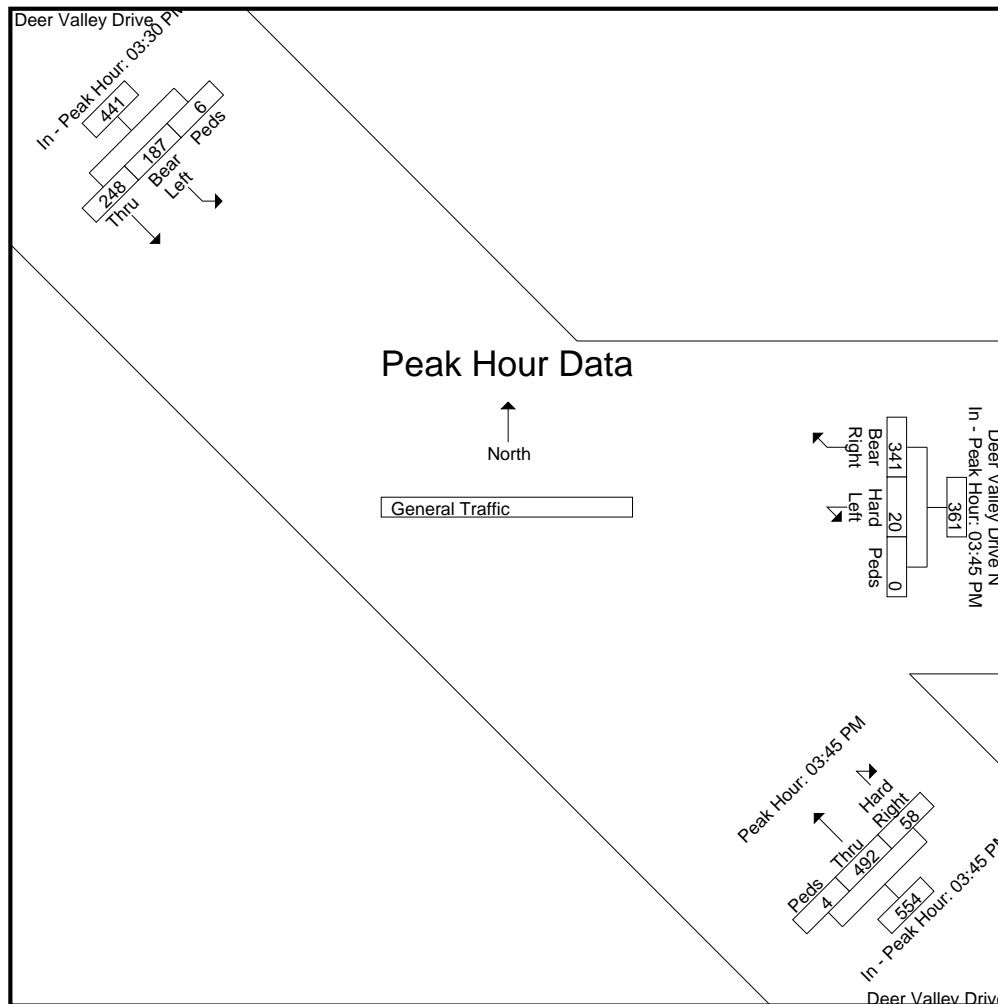

# L2 Data Collection

L2DataCollection.com

Idaho (208) 860-7554 Utah (801) 413-2993

Study: FEHR0119  
Intersection: Deer Valley / Deer Valley N  
City, State: Deer Valley, Utah  
Control: Stop Sign

File Name : Deer Valley Dr & Deer Valley Dr N - D1  
Site Code : Day 1  
Start Date : 2/15/2020  
Page No : 7

Image 1

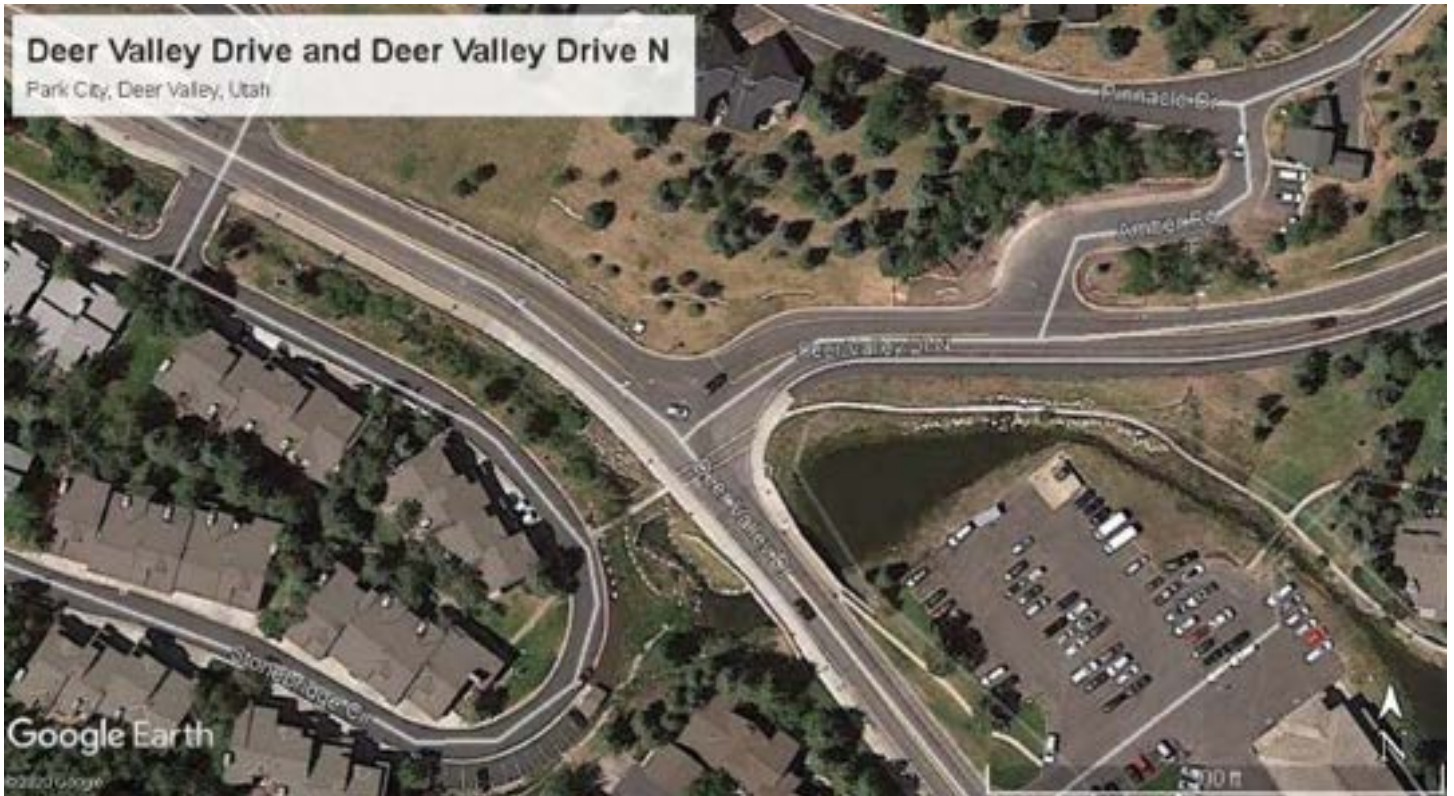



# L2 Data Collection

L2DataCollection.com  
Idaho (208) 860-7554 Utah (801) 413-2993

Study: FEHR0119  
Intersection: Deer Valley/ Deer Valley N  
City, State: Deer Valley, Utah  
Control: Stop Sign

File Name : Deer Valley Dr & Deer Valley Dr N - D2  
Site Code : Day 2  
Start Date : 2/29/2020  
Page No : 1

### Groups Printed- General Traffic

Start Time	Deer Valley Drive From Northwest				Deer Valley Drive N From East				Deer Valley Drive From Southeast				Int. Total	
	Thru	Bear Left	Peds	App. Total	Bear Right	Hard Left	Peds	App. Total	Hard Right	Thru	Peds	App. Total		
07:45 AM	53	73	0	126	21	1	0	22	2	21	0	23	171	
Total	53	73	0	126	21	1	0	22	2	21	0	23	171	
08:00 AM	104	59	0	163	38	0	0	38	2	19	0	21	222	
08:15 AM	150	70	0	220	32	1	0	33	3	19	0	22	275	
08:30 AM	160	35	0	195	36	5	0	41	5	33	0	38	274	
08:45 AM	173	39	0	212	38	1	0	39	2	48	0	50	301	
Total	587	203	0	790	144	7	0	151	12	119	0	131	1072	
09:00 AM	144	32	0	176	50	0	0	50	5	47	1	53	279	
09:15 AM	128	36	0	164	53	4	0	57	2	42	0	44	265	
09:30 AM	149	35	0	184	43	5	0	48	2	31	1	34	266	
-----	Total	421	103	0	524	146	9	0	155	9	120	2	131	810
-----														
03:30 PM	66	48	0	114	103	3	1	107	10	111	0	121	342	
03:45 PM	51	54	0	105	95	4	0	99	10	116	1	127	331	
Total	117	102	0	219	198	7	1	206	20	227	1	248	673	
04:00 PM	43	45	0	88	102	8	0	110	12	159	1	172	370	
04:15 PM	63	52	0	115	76	8	2	86	9	140	0	149	350	
04:30 PM	47	38	0	85	104	2	0	106	13	121	1	135	326	
04:45 PM	57	61	0	118	66	2	0	68	6	97	4	107	293	
Total	210	196	0	406	348	20	2	370	40	517	6	563	1339	
05:00 PM	52	44	0	96	80	4	0	84	11	113	2	126	306	
05:15 PM	31	49	0	80	55	1	0	56	7	89	9	105	241	
Grand Total	1471	770	0	2241	992	49	3	1044	101	1206	20	1327	4612	
Apprch %	65.6	34.4	0		95	4.7	0.3		7.6	90.9	1.5			
Total %	31.9	16.7	0	48.6	21.5	1.1	0.1	22.6	2.2	26.1	0.4	28.8		

# L2 Data Collection

L2DataCollection.com

Idaho (208) 860-7554 Utah (801) 413-2993

Study: FEHR0119  
 Intersection: Deer Valley / Deer Valley N  
 City, State: Deer Valley, Utah  
 Control: Stop Sign

File Name : Deer Valley Dr & Deer Valley Dr N - D2  
 Site Code : Day 2  
 Start Date : 2/29/2020  
 Page No : 2

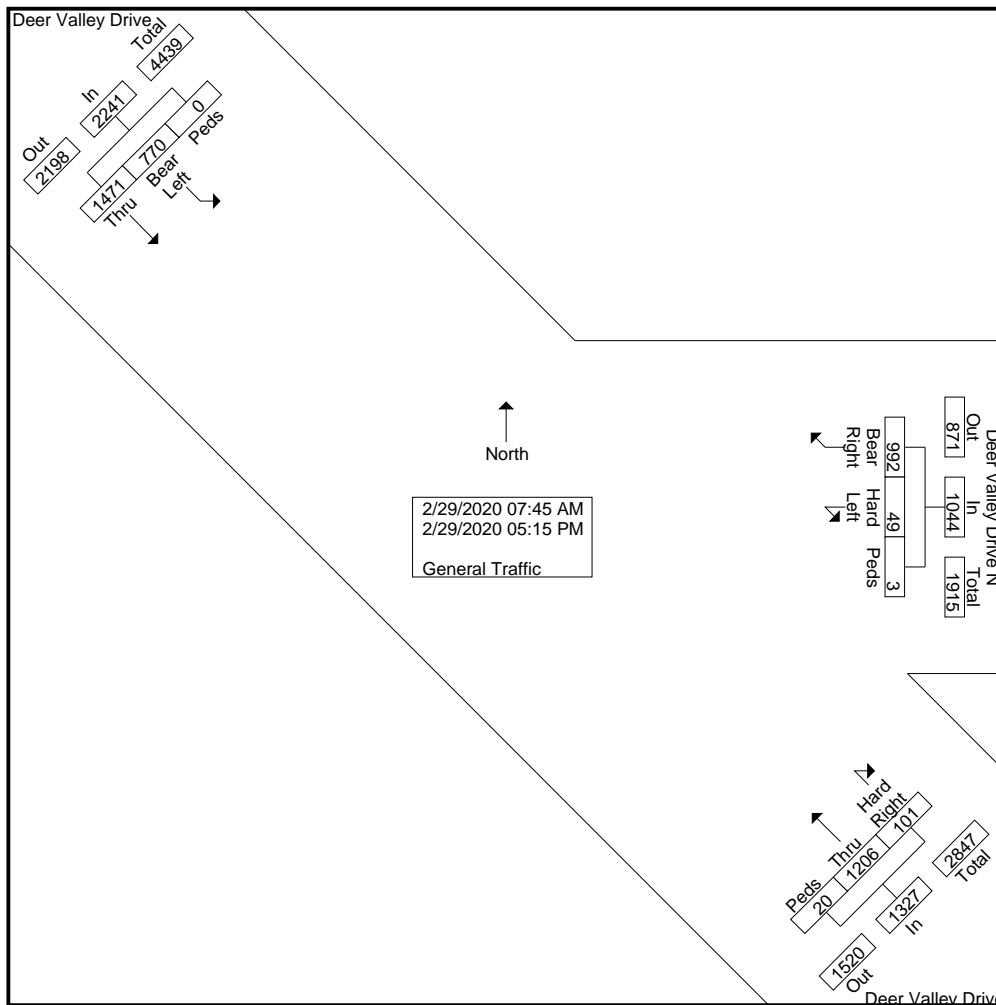

# L2 Data Collection

L2DataCollection.com  
 Idaho (208) 860-7554 Utah (801) 413-2993

Study: FEHR0119  
 Intersection: Deer Valley/ Deer Valley N  
 City, State: Deer Valley, Utah  
 Control: Stop Sign

File Name : Deer Valley Dr & Deer Valley Dr N - D2  
 Site Code : Day 2  
 Start Date : 2/29/2020  
 Page No : 3

Start Time	Deer Valley Drive From Northwest				Deer Valley Drive N From East				Deer Valley Drive From Southeast				Int. Total
	Thru	Bear Left	Peds	App. Total	Bear Right	Hard Left	Peds	App. Total	Hard Right	Thru	Peds	App. Total	
<b>Peak Hour Analysis From 07:45 AM to 11:45 AM - Peak 1 of 1</b>													
Peak Hour for Entire Intersection Begins at 08:15 AM													
08:15 AM	150	70	0	220	32	1	0	33	3	19	0	22	275
08:30 AM	160	35	0	195	36	5	0	41	5	33	0	38	274
08:45 AM	173	39	0	212	38	1	0	39	2	48	0	50	301
09:00 AM	144	32	0	176	50	0	0	50	5	47	1	53	279
Total Volume	627	176	0	803	156	7	0	163	15	147	1	163	1129
% App. Total	78.1	21.9	0		95.7	4.3	0		9.2	90.2	0.6		
PHF	.906	.629	.000	.913	.780	.350	.000	.815	.750	.766	.250	.769	.938

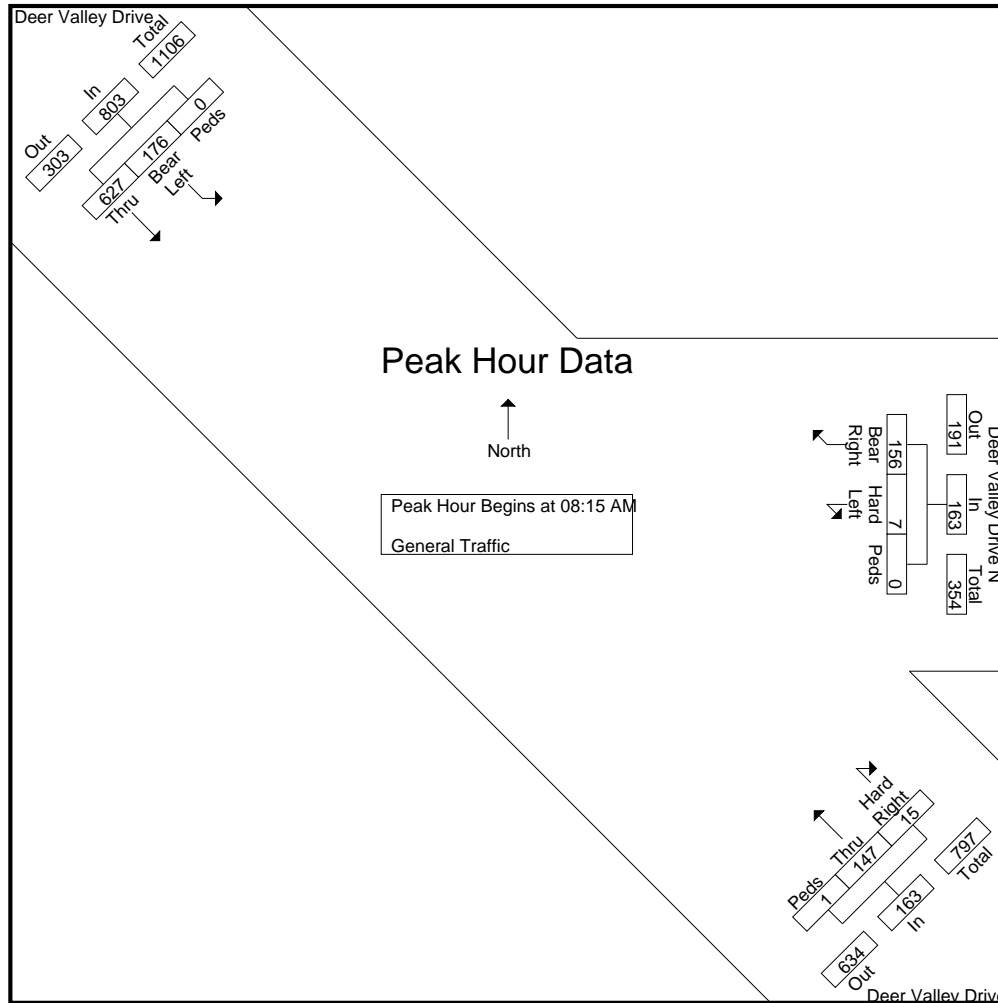

# L2 Data Collection

L2DataCollection.com  
 Idaho (208) 860-7554 Utah (801) 413-2993

Study: FEHR0119  
 Intersection: Deer Valley/ Deer Valley N  
 City, State: Deer Valley, Utah  
 Control: Stop Sign

File Name : Deer Valley Dr & Deer Valley Dr N - D2  
 Site Code : Day 2  
 Start Date : 2/29/2020  
 Page No : 4

Start Time	Deer Valley Drive From Northwest				Deer Valley Drive N From East				Deer Valley Drive From Southeast				Int. Total
	Thru	Bear Left	Peds	App. Total	Bear Right	Hard Left	Peds	App. Total	Hard Right	Thru	Peds	App. Total	

**Peak Hour Analysis From 07:45 AM to 11:45 AM - Peak 1 of 1**

Peak Hour for Each Approach Begins at:

	08:15 AM				08:45 AM				08:30 AM			
+0 mins.	150	<b>70</b>	0	<b>220</b>	38	1	0	39	<b>5</b>	33	0	38
+15 mins.	160	35	0	195	50	0	0	50	2	<b>48</b>	0	50
+30 mins.	<b>173</b>	39	0	212	<b>53</b>	4	0	<b>57</b>	5	47	<b>1</b>	<b>53</b>
+45 mins.	144	32	0	176	43	<b>5</b>	0	48	2	42	0	44
Total Volume	627	176	0	803	184	10	0	194	14	170	1	185
% App. Total	78.1	21.9	0		94.8	5.2	0		7.6	91.9	0.5	
PHF	.906	.629	.000	.913	.868	.500	.000	.851	.700	.885	.250	.873

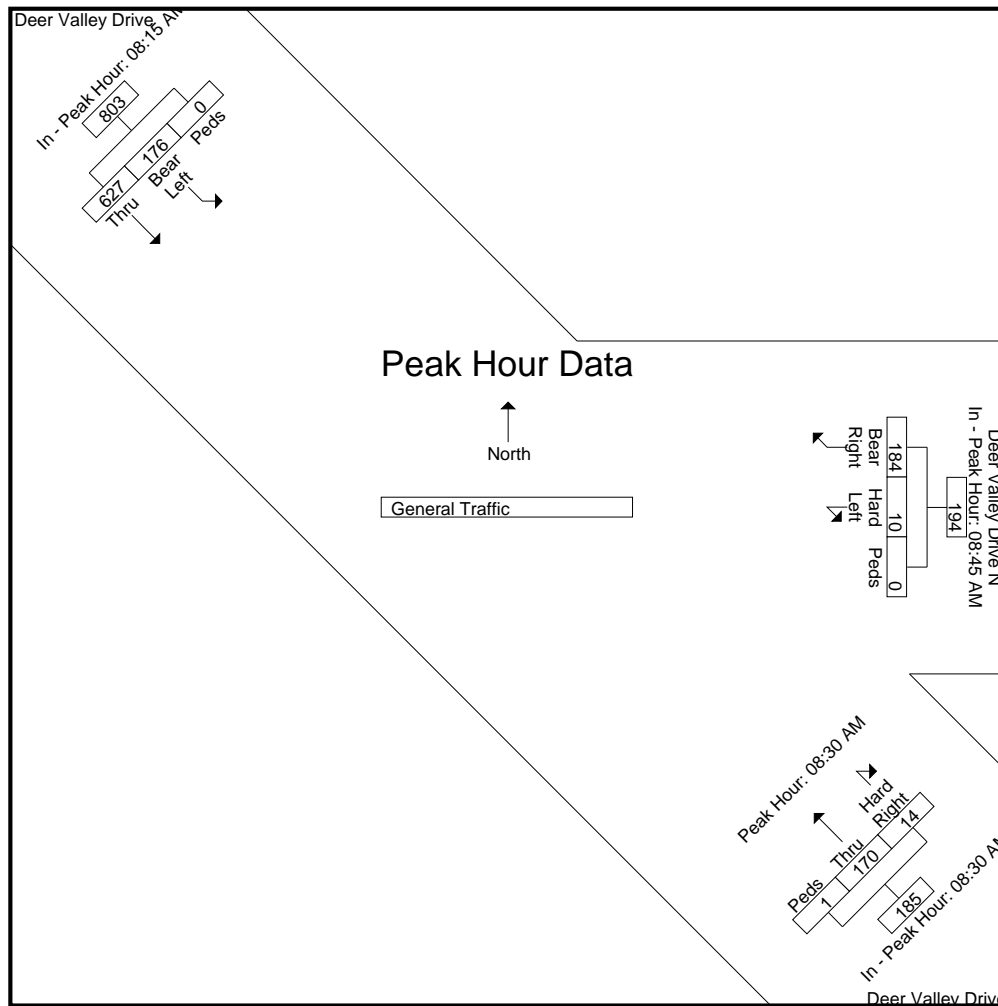

# L2 Data Collection

L2DataCollection.com  
 Idaho (208) 860-7554 Utah (801) 413-2993

Study: FEHR0119  
 Intersection: Deer Valley/ Deer Valley N  
 City, State: Deer Valley, Utah  
 Control: Stop Sign

File Name : Deer Valley Dr & Deer Valley Dr N - D2  
 Site Code : Day 2  
 Start Date : 2/29/2020  
 Page No : 5

Start Time	Deer Valley Drive From Northwest				Deer Valley Drive N From East				Deer Valley Drive From Southeast				Int. Total
	Thru	Bear Left	Peds	App. Total	Bear Right	Hard Left	Peds	App. Total	Hard Right	Thru	Peds	App. Total	
<b>Peak Hour Analysis From 12:00 PM to 05:15 PM - Peak 1 of 1</b>													
Peak Hour for Entire Intersection Begins at 03:30 PM													
03:30 PM	66	48	0	114	103	3	1	107	10	111	0	121	342
03:45 PM	51	54	0	105	95	4	0	99	10	116	1	127	331
04:00 PM	43	45	0	88	102	8	0	110	12	159	1	172	370
04:15 PM	63	52	0	115	76	8	2	86	9	140	0	149	350
Total Volume	223	199	0	422	376	23	3	402	41	526	2	569	1393
% App. Total	52.8	47.2	0		93.5	5.7	0.7		7.2	92.4	0.4		
PHF	.845	.921	.000	.917	.913	.719	.375	.914	.854	.827	.500	.827	.941

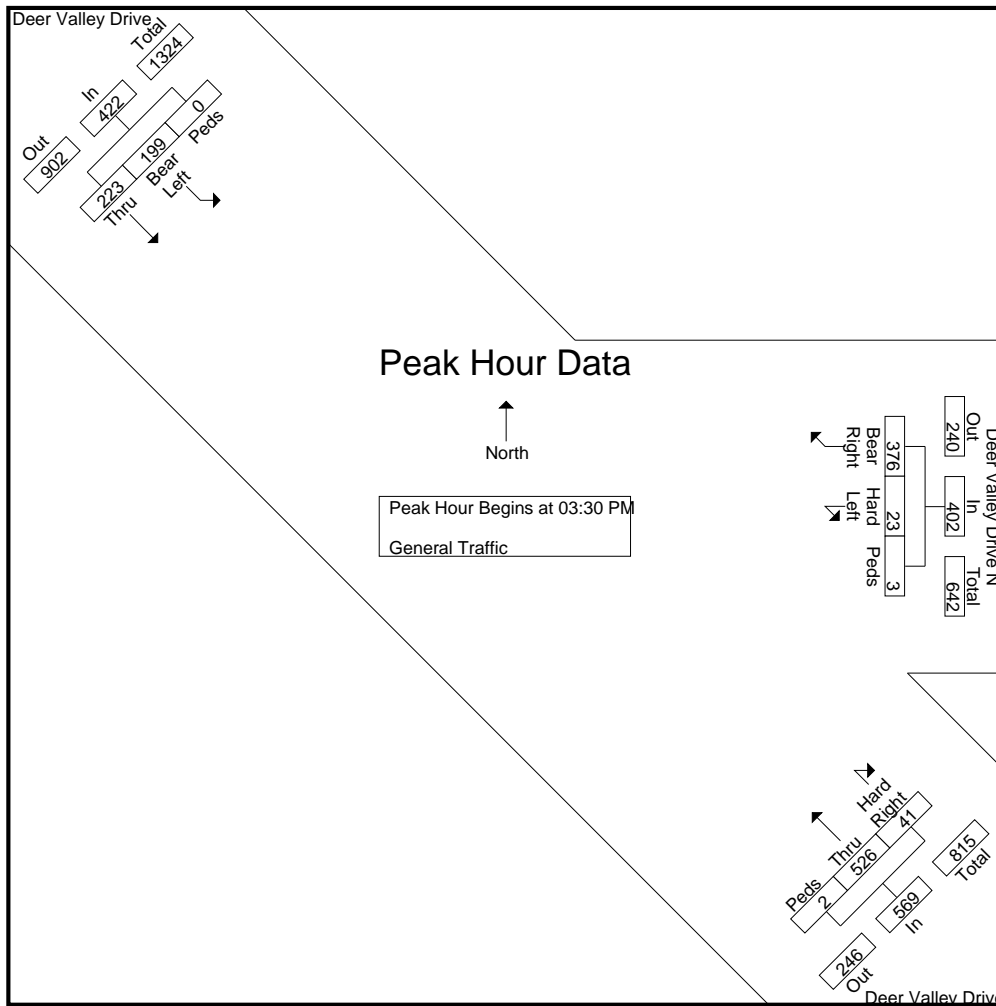



# L2 Data Collection

L2DataCollection.com  
 Idaho (208) 860-7554 Utah (801) 413-2993

Study: FEHR0119  
 Intersection: Deer Valley/ Deer Valley N  
 City, State: Deer Valley, Utah  
 Control: Stop Sign

File Name : Deer Valley Dr & Deer Valley Dr N - D2  
 Site Code : Day 2  
 Start Date : 2/29/2020  
 Page No : 6

Start Time	Deer Valley Drive From Northwest				Deer Valley Drive N From East				Deer Valley Drive From Southeast				Int. Total
	Thru	Bear Left	Peds	App. Total	Bear Right	Hard Left	Peds	App. Total	Hard Right	Thru	Peds	App. Total	

**Peak Hour Analysis From 12:00 PM to 05:15 PM - Peak 1 of 1**

Peak Hour for Each Approach Begins at:

	03:30 PM				03:30 PM				03:45 PM			
+0 mins.	<b>66</b>	48	0	114	<b>103</b>	3	1	107	10	116	<b>1</b>	127
+15 mins.	51	<b>54</b>	0	105	95	4	0	99	12	<b>159</b>	1	<b>172</b>
+30 mins.	43	45	0	88	102	<b>8</b>	0	<b>110</b>	9	140	0	149
+45 mins.	63	52	0	<b>115</b>	76	8	<b>2</b>	86	<b>13</b>	121	1	135
Total Volume	223	199	0	422	376	23	3	402	44	536	3	583
% App. Total	52.8	47.2	0		93.5	5.7	0.7		7.5	91.9	0.5	
PHF	.845	.921	.000	.917	.913	.719	.375	.914	.846	.843	.750	.847

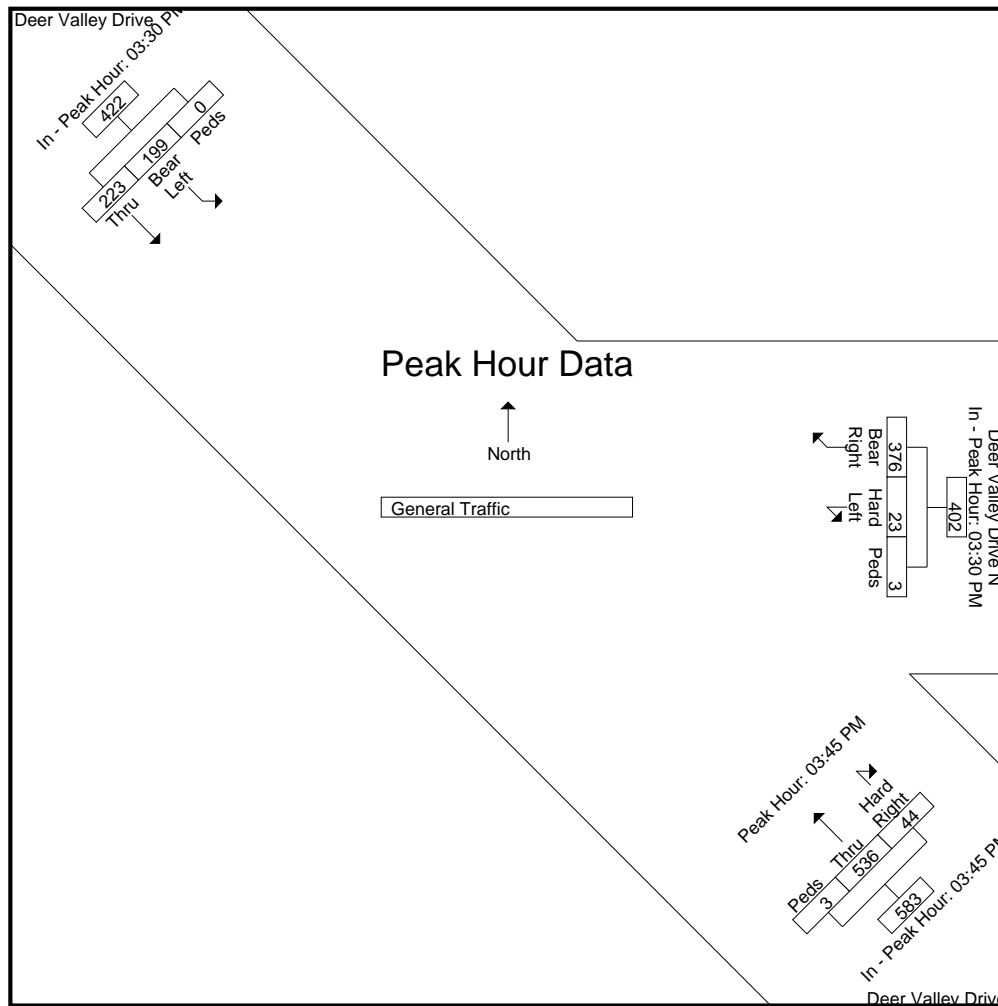

# L2 Data Collection

L2DataCollection.com

Idaho (208) 860-7554 Utah (801) 413-2993

Study: FEHR0119  
Intersection: Deer Valley / Deer Valley N  
City, State: Deer Valley, Utah  
Control: Stop Sign

File Name : Deer Valley Dr & Deer Valley Dr N - D2  
Site Code : Day 2  
Start Date : 2/29/2020  
Page No : 7

Image 1

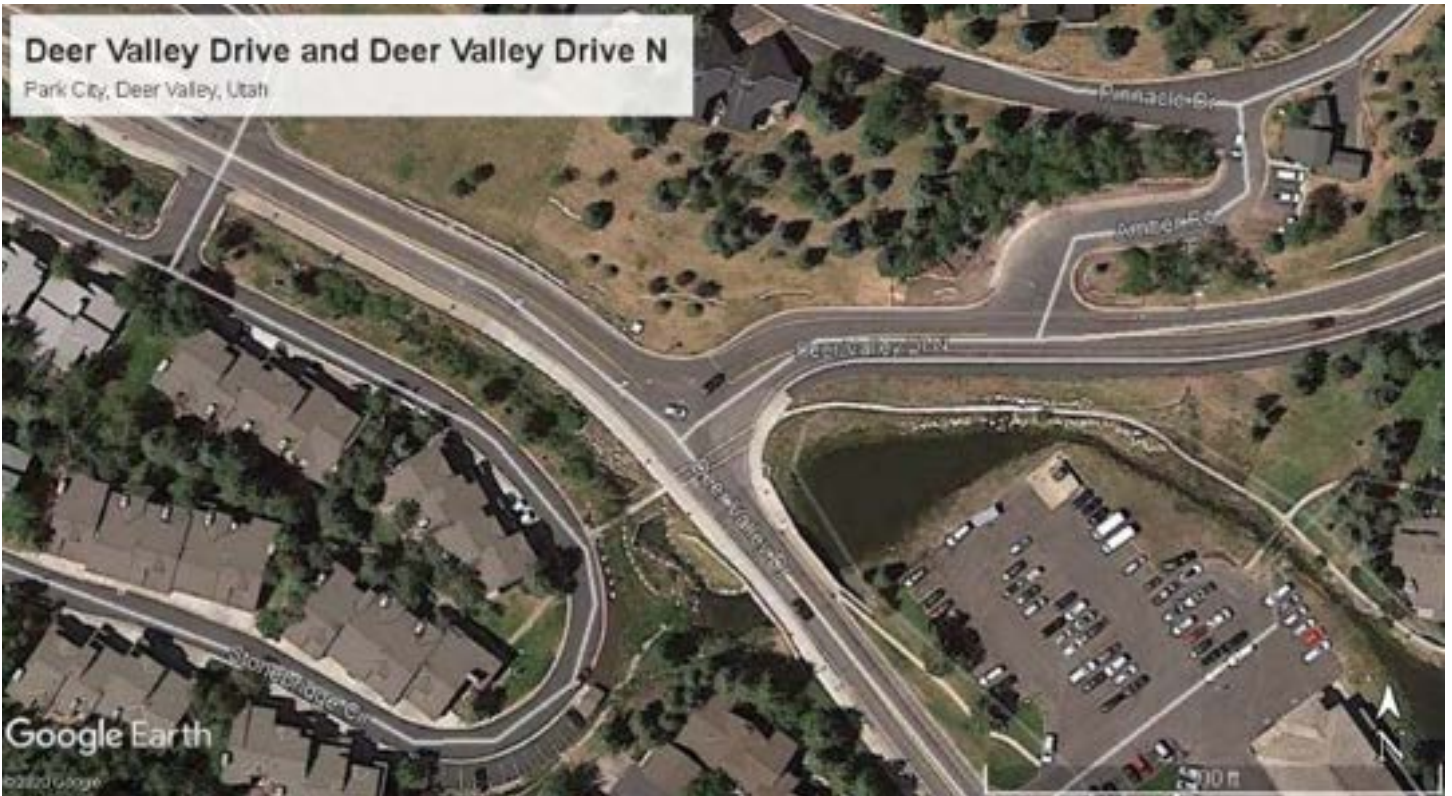

# L2 Data Collection

L2DataCollection.com

Idaho (208) 860-7554 Utah (801) 413-2993

Study: FEHR0124  
 Intersection: Deer Valley Dr / Marsac Av  
 City, State: Park City, Utah  
 Control: Yields

File Name : Deer Valley Dr & Marsac Ave RDBT  
 Site Code : Saturday  
 Start Date : 12/19/2020  
 Page No : 1

### Groups Printed- General Traffic - Turns

Start Time	Deer Valley Drive From North					Deer Valley Drive From East					Marsac Avenue From South					To Swede Alley (Buses Only) From West					Int. Total
	Right	Thru	Left	Peds	App. Total	Right	Thru	Left	Peds	App. Total	Right	Thru	Left	Peds	App. Total	Right	Thru	Left	Peds	App. Total	
07:45 AM	1	105	141	0	247	37	2	5	0	44	3	19	0	1	23	1	3	1	0	5	319
Total	1	105	141	0	247	37	2	5	0	44	3	19	0	1	23	1	3	1	0	5	319
08:00 AM	2	59	173	0	234	30	2	1	0	33	12	23	0	1	36	1	3	0	1	5	308
08:15 AM	3	78	171	0	252	46	3	4	0	53	12	22	0	1	35	0	3	0	2	5	345
08:30 AM	1	79	171	0	251	39	4	11	0	54	13	22	0	2	37	3	7	0	1	11	353
08:45 AM	2	74	178	0	254	55	4	6	2	67	16	26	1	3	46	3	6	1	4	14	381
Total	8	290	693	0	991	170	13	22	2	207	53	93	1	7	154	7	19	1	8	35	1387
09:00 AM	3	70	140	0	213	74	4	4	2	84	8	31	0	8	47	4	3	1	6	14	358
09:15 AM	1	74	114	3	192	63	2	6	2	73	9	31	0	1	41	0	4	0	1	5	311
09:30 AM	1	66	116	0	183	75	0	2	2	79	7	35	0	0	42	0	3	1	1	5	309
Total	5	210	370	3	588	212	6	12	6	236	24	97	0	9	130	4	10	2	8	24	978
03:30 PM	5	97	155	0	257	155	2	7	0	164	18	97	0	5	120	4	0	3	0	7	548
03:45 PM	2	90	162	0	254	157	4	9	0	170	17	116	0	7	140	2	4	1	4	11	575
Total	7	187	317	0	511	312	6	16	0	334	35	213	0	12	260	6	4	4	4	18	1123
04:00 PM	1	101	141	0	243	177	1	12	0	190	9	106	1	7	123	1	2	0	3	6	562
04:15 PM	1	93	129	5	228	180	3	9	1	193	16	106	1	2	125	0	3	0	2	5	551
04:30 PM	2	91	144	0	237	176	4	5	0	185	16	100	0	7	123	2	2	4	1	9	554
04:45 PM	3	83	145	0	231	139	3	10	0	152	16	135	1	3	155	0	4	1	0	5	543
Total	7	368	559	5	939	672	11	36	1	720	57	447	3	19	526	3	11	5	6	25	2210
05:00 PM	1	74	135	0	210	129	3	5	1	138	11	104	0	3	118	1	2	1	2	6	472
05:15 PM	3	95	134	0	232	168	0	4	2	174	15	132	1	3	151	1	2	1	4	8	565
Grand Total	32	1329	2349	8	3718	1700	41	100	12	1853	198	1105	5	54	1362	23	51	15	32	121	7054
Apprch %	0.9	35.7	63.2	0.2		91.7	2.2	5.4	0.6		14.5	81.1	0.4	4		19	42.1	12.4	26.4		
Total %	0.5	18.8	33.3	0.1	52.7	24.1	0.6	1.4	0.2	26.3	2.8	15.7	0.1	0.8	19.3	0.3	0.7	0.2	0.5	1.7	
General Traffic	32	1329	1826	8	3195	1700	41	96	12	1849	198	1105	1	54	1358	23	51	14	32	120	6522
% General Traffic	100	100	77.7	100	85.9	100	100	96	100	99.8	100	100	20	100	99.7	100	100	93.3	100	99.2	92.5
U-Turns	0	0	523	0	523	0	0	4	0	4	0	0	4	0	4	0	0	1	0	1	532
% U-Turns	0	0	22.3	0	14.1	0	0	4	0	0.2	0	0	80	0	0.3	0	0	6.7	0	0.8	7.5

# L2 Data Collection

L2DataCollection.com  
 Idaho (208) 860-7554 Utah (801) 413-2993

Study: FEHR0124  
 Intersection: Deer Valley Dr / Marsac Av  
 City, State: Park City, Utah  
 Control: Yields

File Name : Deer Valley Dr & Marsac Ave RDBT  
 Site Code : Saturday  
 Start Date : 12/19/2020  
 Page No : 2

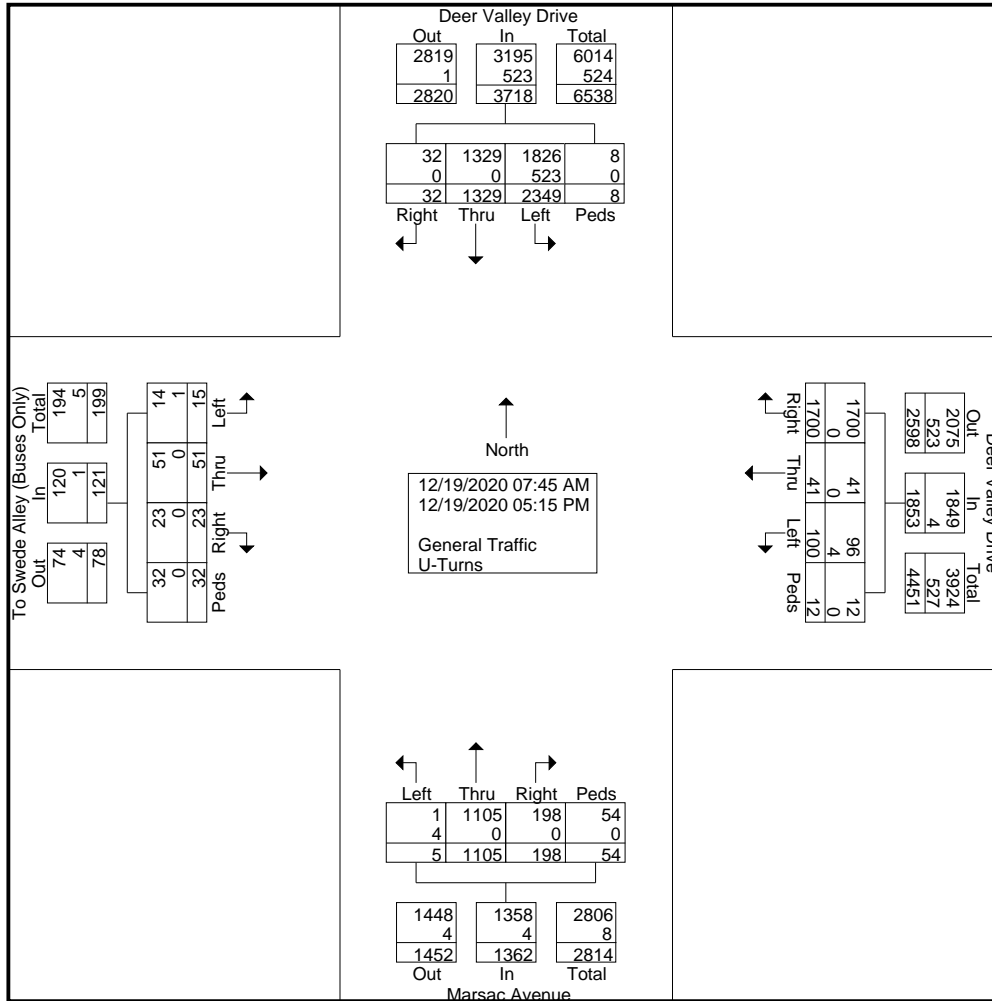

# L2 Data Collection

L2DataCollection.com  
Idaho (208) 860-7554 Utah (801) 413-2993

Study: FEHR0124  
Intersection: Deer Valley Dr / Marsac Av  
City, State: Park City, Utah  
Control: Yields

File Name : Deer Valley Dr & Marsac Ave RDBT  
Site Code : Saturday  
Start Date : 12/19/2020  
Page No : 3

Start Time	Deer Valley Drive From North					Deer Valley Drive From East					Marsac Avenue From South					To Swede Alley (Buses Only) From West					Int. Total
	Right	Thru	Left	Peds	App. Total	Right	Thru	Left	Peds	App. Total	Right	Thru	Left	Peds	App. Total	Right	Thru	Left	Peds	App. Total	

**Peak Hour Analysis From 07:45 AM to 11:45 AM - Peak 1 of 1**

Peak Hour for Entire Intersection Begins at 08:15 AM

08:15 AM	3	78	171	0	252	46	3	4	0	53	12	22	0	1	35	0	3	0	2	5	345
08:30 AM	1	79	171	0	251	39	4	11	0	54	13	22	0	2	37	3	7	0	1	11	353
08:45 AM	2	74	178	0	254	55	4	6	2	67	16	26	1	3	46	3	6	1	4	14	381
09:00 AM	3	70	140	0	213	74	4	4	2	84	8	31	0	8	47	4	3	1	6	14	358
Total Volume	9	301	660	0	970	214	15	25	4	258	49	101	1	14	165	10	19	2	13	44	1437
% App. Total	0.9	31	68	0		82.9	5.8	9.7	1.6		29.7	61.2	0.6	8.5		22.7	43.2	4.5	29.5		
PHF	.750	.953	.927	.000	.955	.723	.938	.568	.500	.768	.766	.815	.250	.438	.878	.625	.679	.500	.542	.786	.943
General Traffic	9	301	641	0	951	214	15	25	4	258	49	101	1	14	165	10	19	2	13	44	1418
% General Traffic	100	100	97.1	0	98.0	100	100	100	100	100	100	100	100	100	100	100	100	100	100	100	98.7
U-Turns	0	0	19	0	19	0	0	0	0	0	0	0	0	0	0	0	0	0	0	0	19
% U-Turns	0	0	2.9	0	2.0	0	0	0	0	0	0	0	0	0	0	0	0	0	0	0	1.3

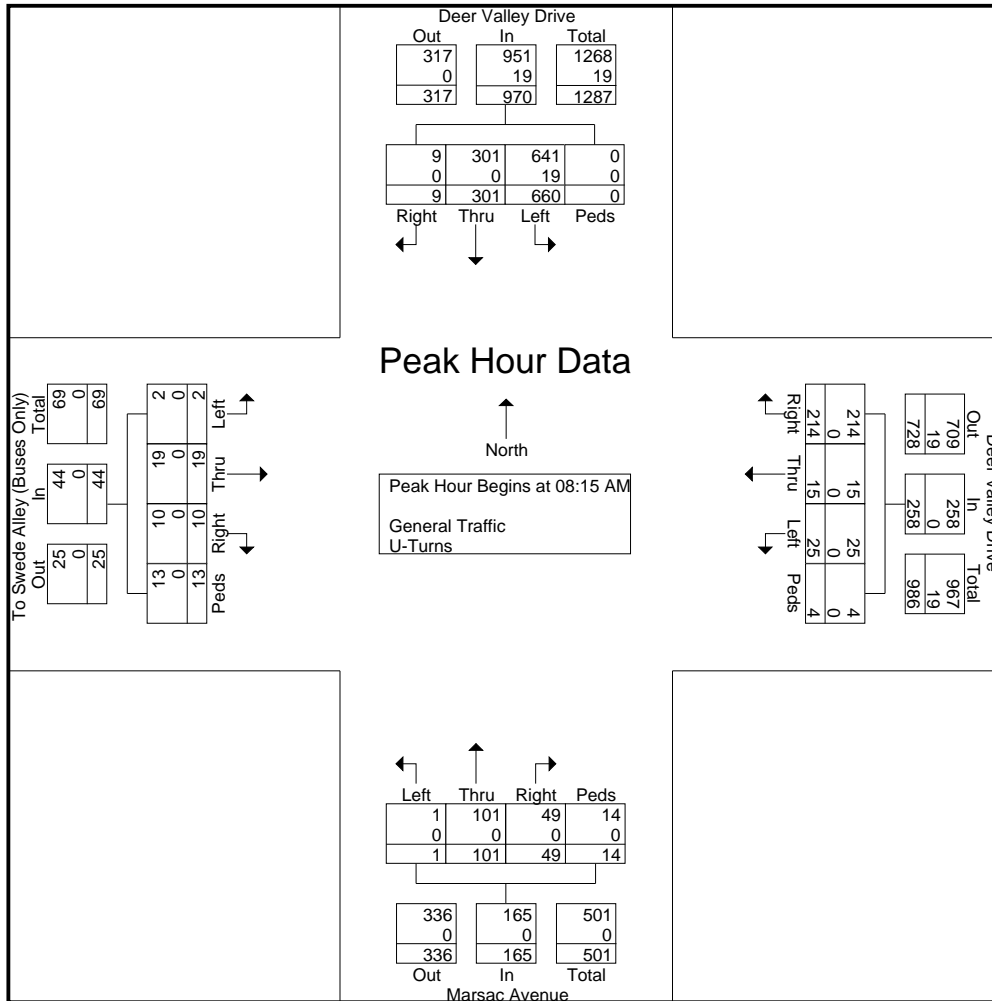

# L2 Data Collection

L2DataCollection.com  
Idaho (208) 860-7554 Utah (801) 413-2993

Study: FEHR0124  
Intersection: Deer Valley Dr / Marsac Av  
City, State: Park City, Utah  
Control: Yields

File Name : Deer Valley Dr & Marsac Ave RDBT  
Site Code : Saturday  
Start Date : 12/19/2020  
Page No : 4

Start Time	Deer Valley Drive From North					Deer Valley Drive From East					Marsac Avenue From South					To Swede Alley (Buses Only) From West					Int. Total
	Right	Thru	Left	Peds	App. Total	Right	Thru	Left	Peds	App. Total	Right	Thru	Left	Peds	App. Total	Right	Thru	Left	Peds	App. Total	

**Peak Hour Analysis From 07:45 AM to 11:45 AM - Peak 1 of 1**

Peak Hour for Each Approach Begins at:

	08:00 AM					08:45 AM					08:45 AM					08:15 AM				
+0 mins.	2	59	173	0	234	55	4	6	2	67	16	26	1	3	46	0	3	0	2	5
+15 mins.	3	78	171	0	252	74	4	4	2	84	8	31	0	8	47	3	7	0	1	11
+30 mins.	1	79	171	0	251	63	2	6	2	73	9	31	0	1	41	3	6	1	4	14
+45 mins.	2	74	178	0	254	75	0	2	2	79	7	35	0	0	42	4	3	1	6	14
Total Volume	8	290	693	0	991	267	10	18	8	303	40	123	1	12	176	10	19	2	13	44
% App. Total	0.8	29.3	69.9	0		88.1	3.3	5.9	2.6		22.7	69.9	0.6	6.8		22.7	43.2	4.5	29.5	
PHF	.667	.918	.973	.000	.975	.890	.625	.750	1.000	.902	.625	.879	.250	.375	.936	.625	.679	.500	.542	.786
General Traffic	8	290	673	0	971	267	10	18	8	303	40	123	1	12	176	10	19	2	13	44
% General Traffic	100	100	97.1	0	98	100	100	100	100	100	100	100	100	100	100	100	100	100	100	100
U-Turns	0	0	20	0	20	0	0	0	0	0	0	0	0	0	0	0	0	0	0	0
% U-Turns	0	0	2.9	0	2	0	0	0	0	0	0	0	0	0	0	0	0	0	0	0

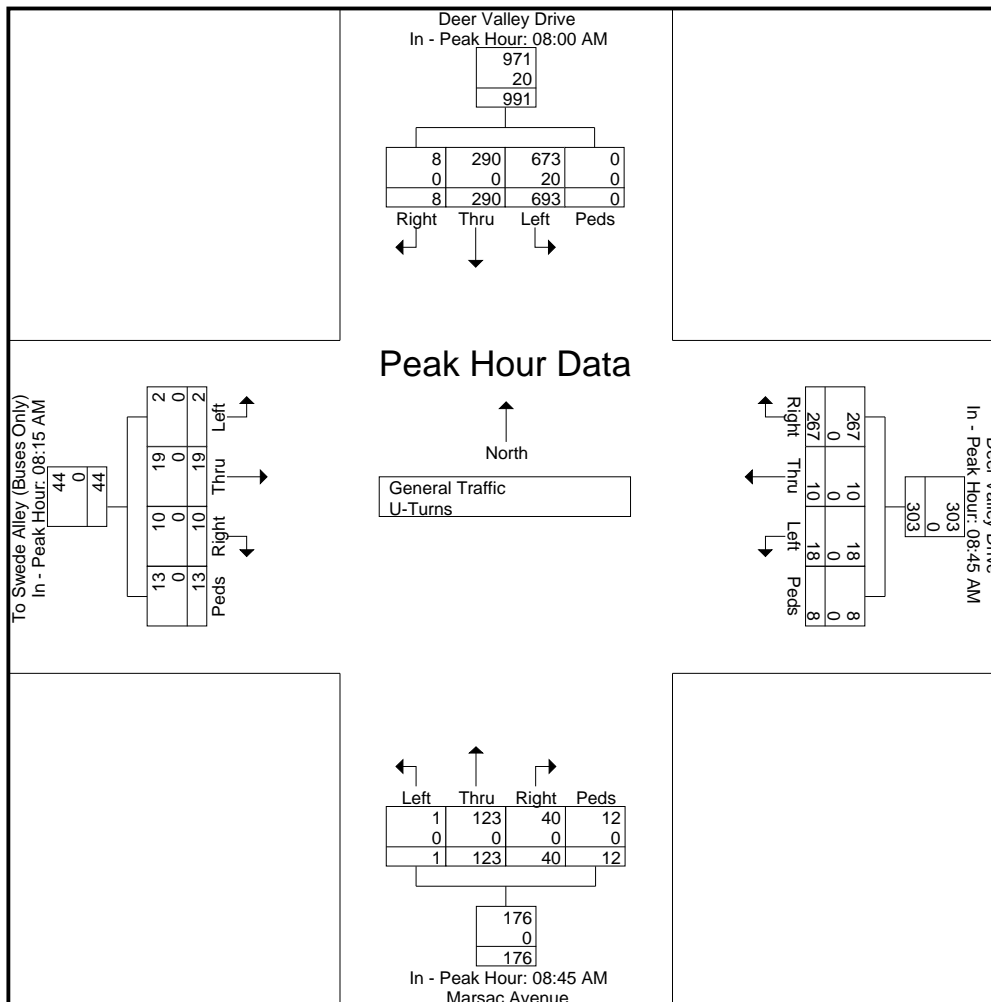



# L2 Data Collection

L2DataCollection.com  
Idaho (208) 860-7554 Utah (801) 413-2993

Study: FEHR0124  
Intersection: Deer Valley Dr / Marsac Av  
City, State: Park City, Utah  
Control: Yields

File Name : Deer Valley Dr & Marsac Ave RDBT  
Site Code : Saturday  
Start Date : 12/19/2020  
Page No : 5

Start Time	Deer Valley Drive From North					Deer Valley Drive From East					Marsac Avenue From South					To Swede Alley (Buses Only) From West					Int. Total
	Right	Thru	Left	Peds	App. Total	Right	Thru	Left	Peds	App. Total	Right	Thru	Left	Peds	App. Total	Right	Thru	Left	Peds	App. Total	

**Peak Hour Analysis From 12:00 PM to 05:15 PM - Peak 1 of 1**

Peak Hour for Entire Intersection Begins at 03:45 PM

03:45 PM	2	90	162	0	254	157	4	9	0	170	17	116	0	7	140	2	4	1	4	11	575
04:00 PM	1	101	141	0	243	177	1	12	0	190	9	106	1	7	123	1	2	0	3	6	562
04:15 PM	1	93	129	5	228	180	3	9	1	193	16	106	1	2	125	0	3	0	2	5	551
04:30 PM	2	91	144	0	237	176	4	5	0	185	16	100	0	7	123	2	2	4	1	9	554
Total Volume	6	375	576	5	962	690	12	35	1	738	58	428	2	23	511	5	11	5	10	31	2242
% App. Total	0.6	39	59.9	0.5		93.5	1.6	4.7	0.1		11.4	83.8	0.4	4.5		16.1	35.5	16.1	32.3		
PHF	.750	.928	.889	.250	.947	.958	.750	.729	.250	.956	.853	.922	.500	.821	.913	.625	.688	.313	.625	.705	.975
General Traffic	6	375	347	5	733	690	12	34	1	737	58	428	0	23	509	5	11	5	10	31	2010
% General Traffic	100	100	60.2	100	76.2	100	100	97.1	100	99.9	100	100	0	100	99.6	100	100	100	100	100	89.7
U-Turns	0	0	229	0	229	0	0	1	0	1	0	0	2	0	2	0	0	0	0	0	232
% U-Turns	0	0	39.8	0	23.8	0	0	2.9	0	0.1	0	0	100	0	0.4	0	0	0	0	0	10.3

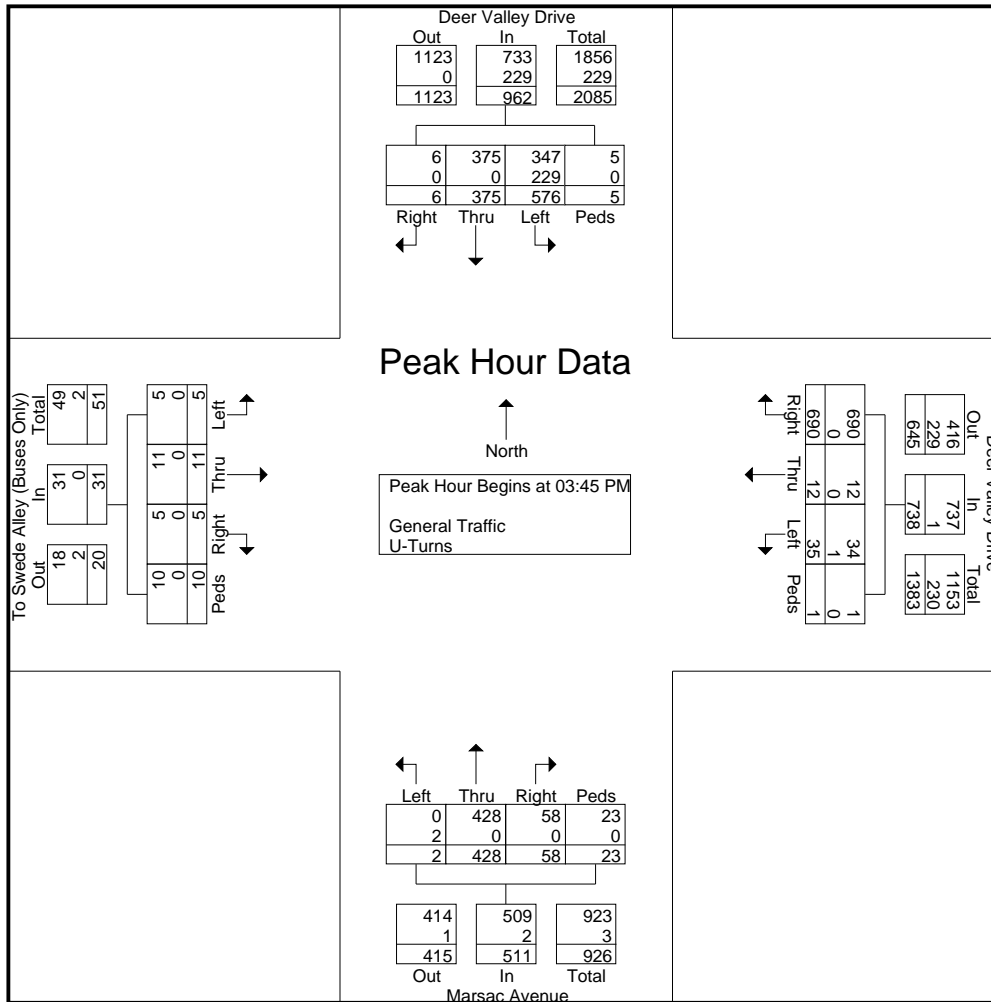

# L2 Data Collection

L2DataCollection.com  
Idaho (208) 860-7554 Utah (801) 413-2993

Study: FEHR0124  
Intersection: Deer Valley Dr / Marsac Av  
City, State: Park City, Utah  
Control: Yields

File Name : Deer Valley Dr & Marsac Ave RDBT  
Site Code : Saturday  
Start Date : 12/19/2020  
Page No : 6

Start Time	Deer Valley Drive From North					Deer Valley Drive From East					Marsac Avenue From South					To Swede Alley (Buses Only) From West					Int. Total
	Right	Thru	Left	Peds	App. Total	Right	Thru	Left	Peds	App. Total	Right	Thru	Left	Peds	App. Total	Right	Thru	Left	Peds	App. Total	

**Peak Hour Analysis From 12:00 PM to 05:15 PM - Peak 1 of 1**

Peak Hour for Each Approach Begins at:

	03:30 PM					03:45 PM					04:30 PM					03:45 PM				
+0 mins.	5	97	155	0	257	157	4	9	0	170	16	100	0	7	123	2	4	1	4	11
+15 mins.	2	90	162	0	254	177	1	12	0	190	16	135	1	3	155	1	2	0	3	6
+30 mins.	1	101	141	0	243	180	3	9	1	193	11	104	0	3	118	0	3	0	2	5
+45 mins.	1	93	129	5	228	176	4	5	0	185	15	132	1	3	151	2	2	4	1	9
Total Volume	9	381	587	5	982	690	12	35	1	738	58	471	2	16	547	5	11	5	10	31
% App. Total	0.9	38.8	59.8	0.5		93.5	1.6	4.7	0.1		10.6	86.1	0.4	2.9		16.1	35.5	16.1	32.3	
PHF	.450	.943	.906	.250	.955	.958	.750	.729	.250	.956	.906	.872	.500	.571	.882	.625	.688	.313	.625	.705
General Traffic	9	381	367	5	762	690	12	34	1	737	58	471	0	16	545	5	11	5	10	31
% General Traffic	100	100	62.5	100	77.6	100	100	97.1	100	99.9	100	100	0	100	99.6	100	100	100	100	100
U-Turns	0	0	220	0	220	0	0	1	0	1	0	0	2	0	2	0	0	0	0	0
% U-Turns	0	0	37.5	0	22.4	0	0	2.9	0	0.1	0	0	100	0	0.4	0	0	0	0	0

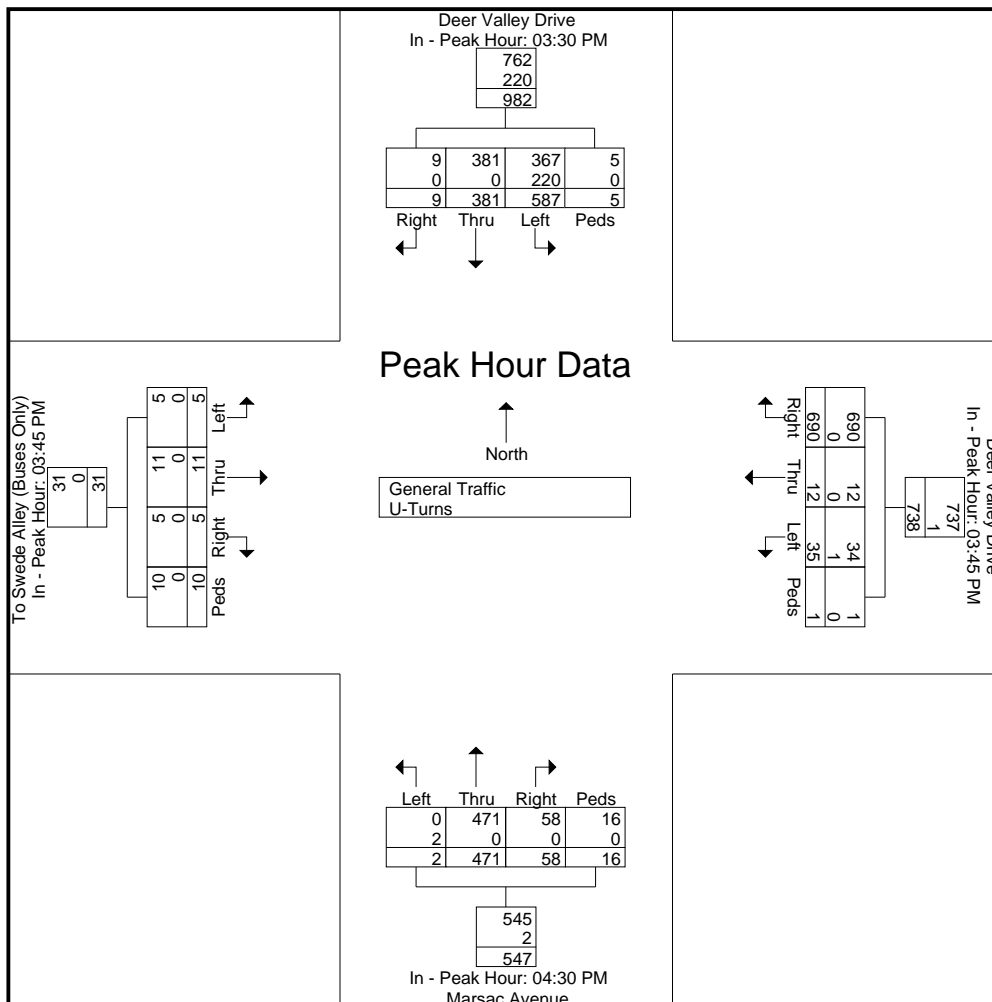

# L2 Data Collection

L2DataCollection.com

Idaho (208) 860-7554 Utah (801) 413-2993

Study: FEHR0124  
Intersection: Deer Valley Dr / Marsac Av  
City, State: Park City, Utah  
Control: Yields

File Name : Deer Valley Dr & Marsac Ave RDBT  
Site Code : Saturday  
Start Date : 12/19/2020  
Page No : 7

Image 1



# L2 Data Collection

L2DataCollection.com  
Idaho (208) 860-7554 Utah (801) 413-2993

Study: FEHR0124  
Intersection: Deer Valley Dr / Bonanza  
City, State: Park City, Utah  
Control: Signalized

File Name : Deer Valley Dr & Bonanza Dr  
Site Code : Saturday  
Start Date : 12/19/2020  
Page No : 1

### Groups Printed- General Traffic

Start Time	Bonanza Drive From Northeast				Deer Valley Drive From South				Deer Valley Drive From West				Int. Total
	Bear Right	Bear Left	Peds	App. Total	Bear Right	Left	Peds	App. Total	Right	Bear Left	Peds	App. Total	
07:45 AM	34	138	0	172	21	37	0	58	137	13	0	150	380
Total	34	138	0	172	21	37	0	58	137	13	0	150	380
08:00 AM	26	111	0	137	30	42	0	72	147	8	0	155	364
08:15 AM	49	115	0	164	24	60	0	84	141	14	0	155	403
08:30 AM	51	113	0	164	23	48	0	71	137	23	0	160	395
08:45 AM	40	130	0	170	32	58	0	90	137	23	0	160	420
Total	166	469	0	635	109	208	0	317	562	68	0	630	1582
09:00 AM	28	111	0	139	49	57	0	106	120	29	0	149	394
09:15 AM	22	85	0	107	27	70	0	97	112	34	0	146	350
09:30 AM	26	90	0	116	38	54	0	92	121	30	0	151	359
-----													
Total	76	286	0	362	114	181	0	295	353	93	0	446	1103
-----													
03:30 PM	23	90	0	113	146	174	0	320	120	58	0	178	611
03:45 PM	41	110	1	152	147	184	0	331	110	67	0	177	660
Total	64	200	1	265	293	358	0	651	230	125	0	355	1271
04:00 PM	25	92	0	117	155	175	0	330	119	59	0	178	625
04:15 PM	26	103	0	129	142	177	0	319	110	63	0	173	621
04:30 PM	31	94	0	125	176	182	0	358	99	50	0	149	632
04:45 PM	17	86	0	103	130	166	0	296	121	44	0	165	564
Total	99	375	0	474	603	700	0	1303	449	216	0	665	2442
05:00 PM	21	81	0	102	136	171	0	307	110	41	0	151	560
05:15 PM	16	93	0	109	139	141	0	280	136	38	0	174	563
Grand Total	476	1642	1	2119	1415	1796	0	3211	1977	594	0	2571	7901
Apprch %	22.5	77.5	0		44.1	55.9	0		76.9	23.1	0		
Total %	6	20.8	0	26.8	17.9	22.7	0	40.6	25	7.5	0	32.5	

# L2 Data Collection

L2DataCollection.com  
 Idaho (208) 860-7554 Utah (801) 413-2993

Study: FEHR0124  
 Intersection: Deer Valley Dr / Bonanza  
 City, State: Park City, Utah  
 Control: Signalized

File Name : Deer Valley Dr & Bonanza Dr  
 Site Code : Saturday  
 Start Date : 12/19/2020  
 Page No : 2

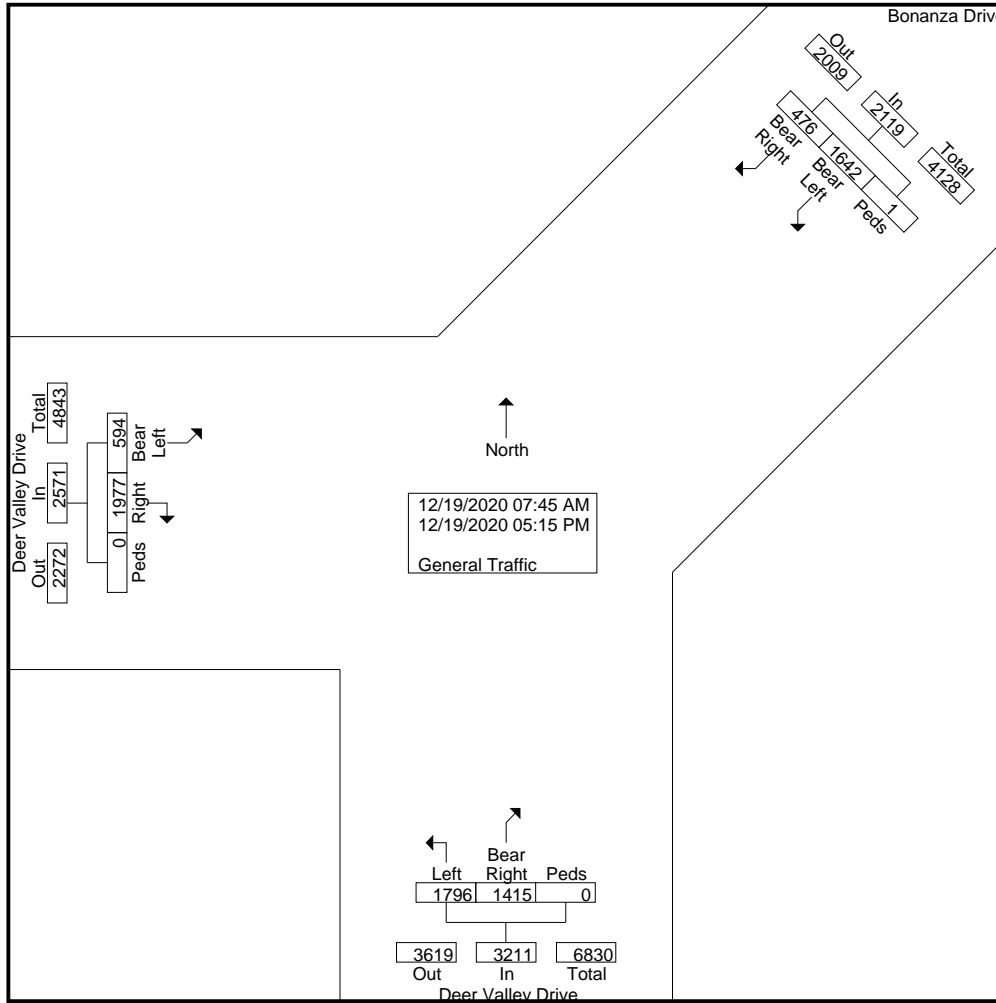

# L2 Data Collection

L2DataCollection.com  
Idaho (208) 860-7554 Utah (801) 413-2993

Study: FEHR0124  
Intersection: Deer Valley Dr / Bonanza  
City, State: Park City, Utah  
Control: Signalized

File Name : Deer Valley Dr & Bonanza Dr  
Site Code : Saturday  
Start Date : 12/19/2020  
Page No : 3

Start Time	Bonanza Drive From Northeast				Deer Valley Drive From South				Deer Valley Drive From West				Int. Total
	Bear Right	Bear Left	Peds	App. Total	Bear Right	Left	Peds	App. Total	Right	Bear Left	Peds	App. Total	
<b>Peak Hour Analysis From 07:45 AM to 11:45 AM - Peak 1 of 1</b>													
Peak Hour for Entire Intersection Begins at 08:15 AM													
08:15 AM	49	115	0	164	24	<b>60</b>	0	84	<b>141</b>	14	0	155	403
08:30 AM	<b>51</b>	113	0	164	23	48	0	71	137	23	0	<b>160</b>	395
08:45 AM	40	<b>130</b>	0	<b>170</b>	32	58	0	90	137	23	0	160	<b>420</b>
09:00 AM	28	111	0	139	<b>49</b>	57	0	<b>106</b>	120	<b>29</b>	0	149	394
Total Volume	168	469	0	637	128	223	0	351	535	89	0	624	1612
% App. Total	26.4	73.6	0		36.5	63.5	0		85.7	14.3	0		
PHF	.824	.902	.000	.937	.653	.929	.000	.828	.949	.767	.000	.975	.960

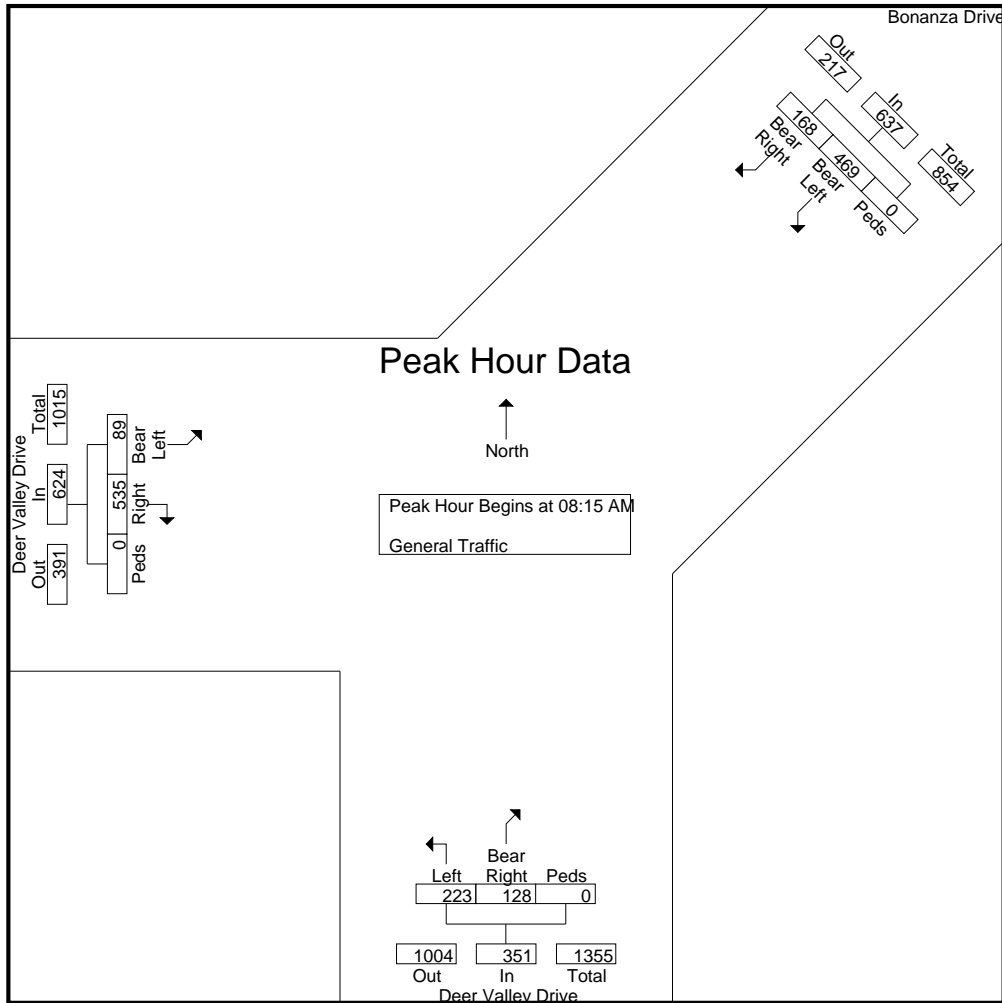



# L2 Data Collection

L2DataCollection.com  
Idaho (208) 860-7554 Utah (801) 413-2993

Study: FEHR0124  
Intersection: Deer Valley Dr / Bonanza  
City, State: Park City, Utah  
Control: Signalized

File Name : Deer Valley Dr & Bonanza Dr  
Site Code : Saturday  
Start Date : 12/19/2020  
Page No : 4

Start Time	Bonanza Drive From Northeast				Deer Valley Drive From South				Deer Valley Drive From West				Int. Total
	Bear Right	Bear Left	Peds	App. Total	Bear Right	Left	Peds	App. Total	Right	Bear Left	Peds	App. Total	
<b>Peak Hour Analysis From 07:45 AM to 11:45 AM - Peak 1 of 1</b>													
Peak Hour for Each Approach Begins at:													
	07:45 AM				08:45 AM				08:00 AM				
+0 mins.	34	138	0	172	32	58	0	90	147	8	0	155	
+15 mins.	26	111	0	137	49	57	0	106	141	14	0	155	
+30 mins.	49	115	0	164	27	70	0	97	137	23	0	160	
+45 mins.	51	113	0	164	38	54	0	92	137	23	0	160	
Total Volume	160	477	0	637	146	239	0	385	562	68	0	630	
% App. Total	25.1	74.9	0		37.9	62.1	0		89.2	10.8	0		
PHF	.784	.864	.000	.926	.745	.854	.000	.908	.956	.739	.000	.984	

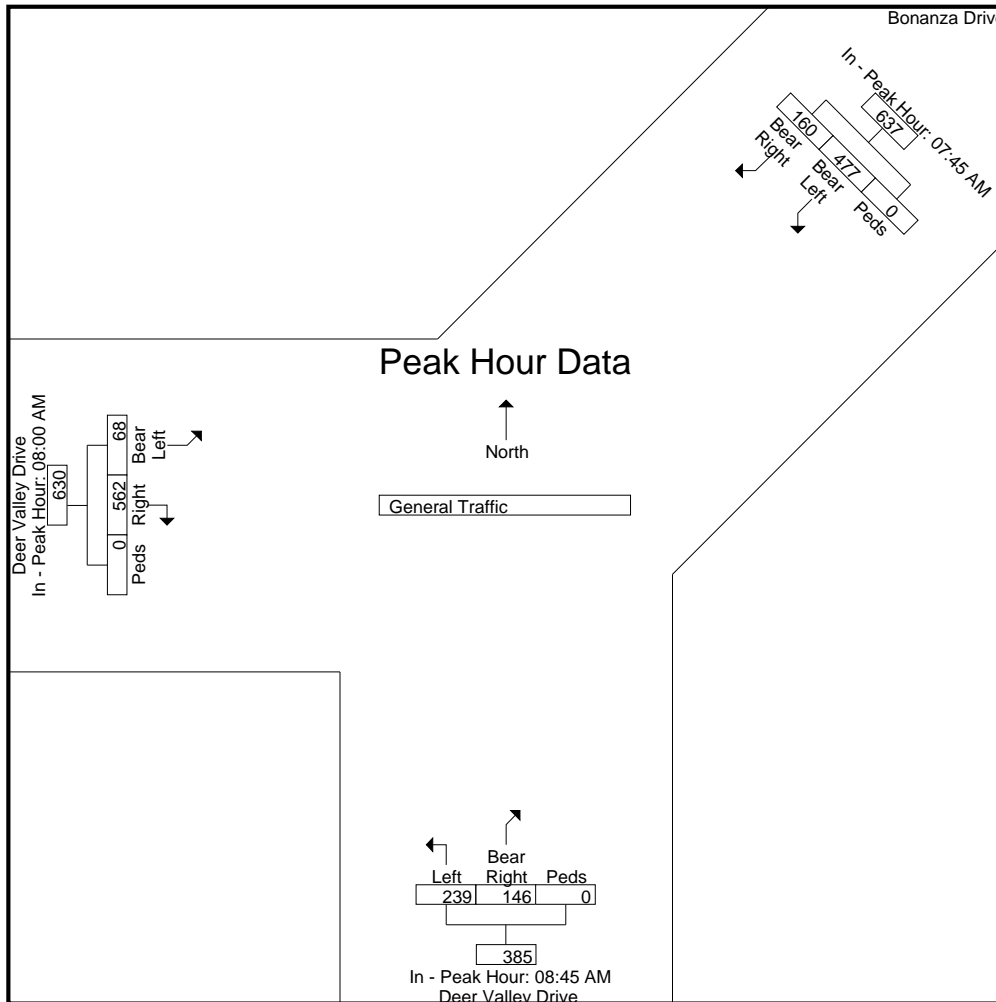

# L2 Data Collection

L2DataCollection.com  
Idaho (208) 860-7554 Utah (801) 413-2993

Study: FEHR0124  
Intersection: Deer Valley Dr / Bonanza  
City, State: Park City, Utah  
Control: Signalized

File Name : Deer Valley Dr & Bonanza Dr  
Site Code : Saturday  
Start Date : 12/19/2020  
Page No : 5

Start Time	Bonanza Drive From Northeast				Deer Valley Drive From South				Deer Valley Drive From West				Int. Total
	Bear Right	Bear Left	Peds	App. Total	Bear Right	Left	Peds	App. Total	Right	Bear Left	Peds	App. Total	
<b>Peak Hour Analysis From 12:00 PM to 05:15 PM - Peak 1 of 1</b>													
Peak Hour for Entire Intersection Begins at 03:45 PM													
03:45 PM	41	110	1	152	147	184	0	331	110	67	0	177	660
04:00 PM	25	92	0	117	155	175	0	330	119	59	0	178	625
04:15 PM	26	103	0	129	142	177	0	319	110	63	0	173	621
04:30 PM	31	94	0	125	176	182	0	358	99	50	0	149	632
Total Volume	123	399	1	523	620	718	0	1338	438	239	0	677	2538
% App. Total	23.5	76.3	0.2		46.3	53.7	0		64.7	35.3	0		
PHF	.750	.907	.250	.860	.881	.976	.000	.934	.920	.892	.000	.951	.961

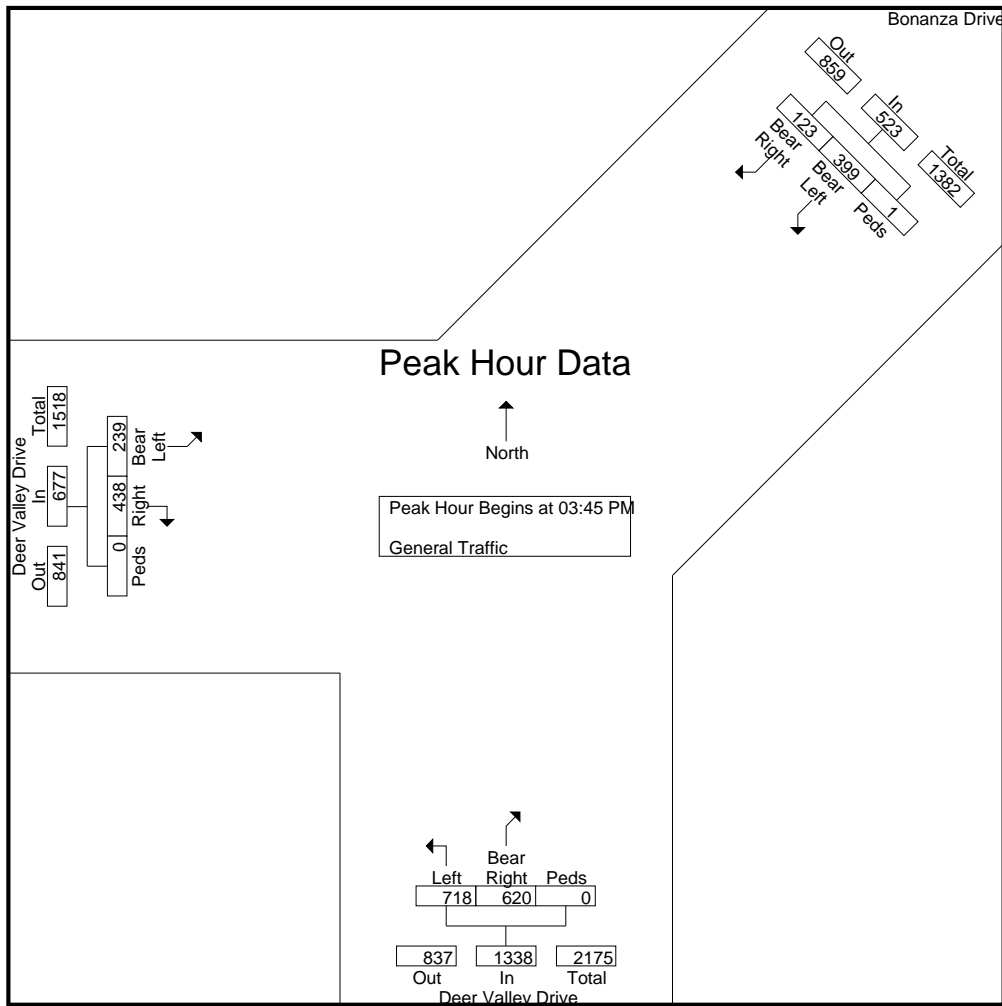

# L2 Data Collection

L2DataCollection.com  
Idaho (208) 860-7554 Utah (801) 413-2993

Study: FEHR0124  
Intersection: Deer Valley Dr / Bonanza  
City, State: Park City, Utah  
Control: Signalized

File Name : Deer Valley Dr & Bonanza Dr  
Site Code : Saturday  
Start Date : 12/19/2020  
Page No : 6

Start Time	Bonanza Drive From Northeast				Deer Valley Drive From South				Deer Valley Drive From West				Int. Total
	Bear Right	Bear Left	Peds	App. Total	Bear Right	Left	Peds	App. Total	Right	Bear Left	Peds	App. Total	
<b>Peak Hour Analysis From 12:00 PM to 05:15 PM - Peak 1 of 1</b>													
Peak Hour for Each Approach Begins at:													
	03:45 PM				03:45 PM				03:30 PM				
+0 mins.	41	110	1	152	147	184	0	331	120	58	0	178	
+15 mins.	25	92	0	117	155	175	0	330	110	67	0	177	
+30 mins.	26	103	0	129	142	177	0	319	119	59	0	178	
+45 mins.	31	94	0	125	176	182	0	358	110	63	0	173	
Total Volume	123	399	1	523	620	718	0	1338	459	247	0	706	
% App. Total	23.5	76.3	0.2		46.3	53.7	0		65	35	0		
PHF	.750	.907	.250	.860	.881	.976	.000	.934	.956	.922	.000	.992	

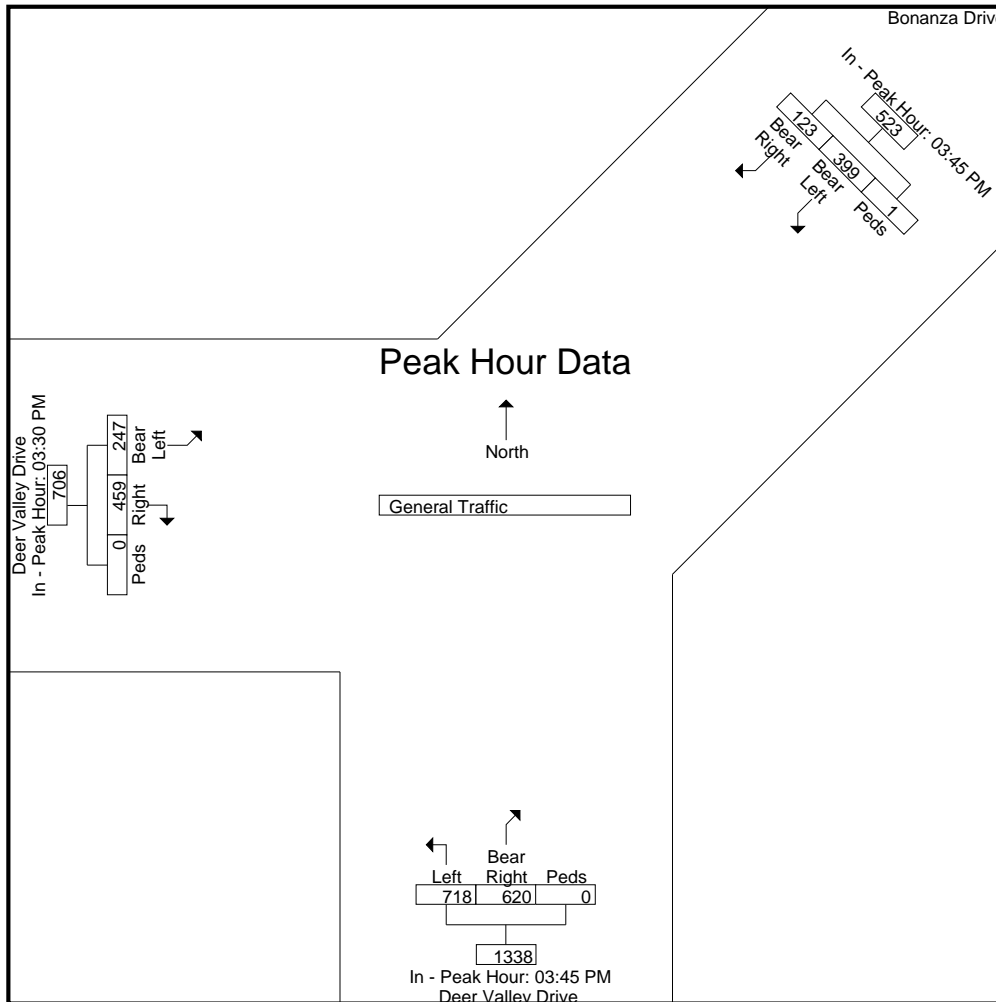

# L2 Data Collection

L2DataCollection.com

Idaho (208) 860-7554 Utah (801) 413-2993

Study: FEHR0124  
Intersection: Deer Valley Dr / Bonanza  
City, State: Park City, Utah  
Control: Signalized

File Name : Deer Valley Dr & Bonanza Dr  
Site Code : Saturday  
Start Date : 12/19/2020  
Page No : 7

Image 1



## Intersection Turning Movement Summary

<b>Intersection:</b>	Deer Valley Drive East/Queen Esther Drive	<b>Date:</b>	3-3-22, Thu
<b>North/South:</b>	Deer Valley Drive East	<b>Day of Week Adjustment:</b>	100.0%
<b>East/West:</b>	Queen Esther Drive	<b>Month of Year Adjustment:</b>	100.0%
<b>Jurisdiction:</b>	Park City	<b>Adjustment Station #:</b>	
<b>Project Title:</b>	Snow Park Development	<b>Growth Rate:</b>	0.0%
<b>Project No:</b>	UT20-2245	<b>Number of Years:</b>	0
<b>Weather:</b>			

AM PEAK HOUR PERIOD: **9:00-10:00**  
 AM PEAK 15 MINUTE PERIOD: **9:15-9:30**  
 AM PHF: **0.99**

NOON PEAK HOUR PERIOD:  
 NOON PEAK 15 MINUTE PERIOD:  
 NOON PHF: **####**

PM PEAK HOUR PERIOD: **15:00-16:00**  
 PM PEAK 15 MINUTE PERIOD: **15:15-15:30**  
 PM PHF: **0.81**

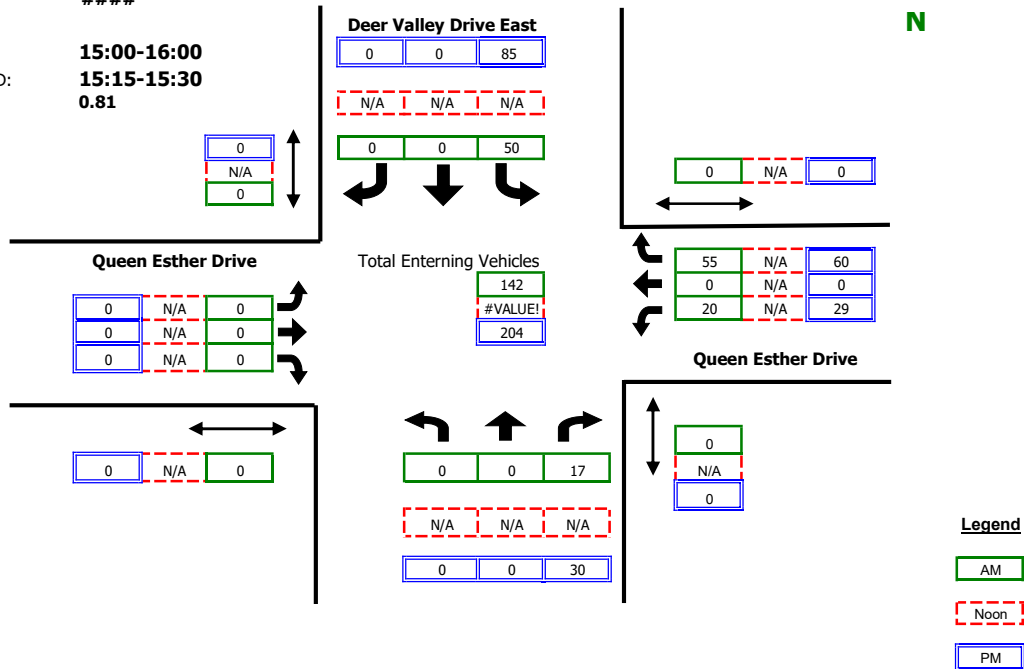

RAW COUNT SUMMARIES	Deer Valley Drive East Northbound				Deer Valley Drive East Southbound				Queen Esther Drive Eastbound				Queen Esther Drive Westbound			
	Left	Thru	Right	Peds	Left	Thru	Right	Peds	Left	Thru	Right	Peds	Left	Thru	Right	Peds

AM PERIOD COUNTS																	
Period	A	B	C	D	E	F	G	H	I	J	K	L	M	N	O	P	TOTAL
8:00-8:15	0	0	0	0	4	0	0	0	0	0	0	0	5	0	4	0	13
8:15-8:30	0	0	8	0	7	0	0	0	0	0	0	0	9	0	13	0	37
8:30-8:45	0	0	6	0	6	0	0	0	0	0	0	0	5	0	11	0	28
8:45-9:00	0	0	2	0	11	0	0	0	0	0	0	0	10	0	9	0	32
9:00-9:15	0	0	5	0	9	0	0	0	0	0	0	0	7	0	14	0	35
9:15-9:30	0	0	5	0	17	0	0	0	0	0	0	0	4	0	10	0	36
9:30-9:45	0	0	2	0	10	0	0	0	0	0	0	0	6	0	18	0	36
9:45-10:00	0	0	5	0	14	0	0	0	0	0	0	0	3	0	13	0	35

NOON PERIOD COUNTS																	
Period	A	B	C	D	E	F	G	H	I	J	K	L	M	N	O	P	TOTAL
14:00-14:15	0	0	0	0	0	0	0	0	0	0	0	0	0	0	0	0	0
14:15-14:30	0	0	0	0	0	0	0	0	0	0	0	0	0	0	0	0	0
14:30-14:45	0	0	0	0	0	0	0	0	0	0	0	0	0	0	0	0	0
14:45-15:00	0	0	0	0	0	0	0	0	0	0	0	0	0	0	0	0	0
15:00-15:15	0	0	0	0	0	0	0	0	0	0	0	0	0	0	0	0	0
15:15-15:30	0	0	0	0	0	0	0	0	0	0	0	0	0	0	0	0	0
15:30-15:45	0	0	0	0	0	0	0	0	0	0	0	0	0	0	0	0	0
15:45-14:00	0	0	0	0	0	0	0	0	0	0	0	0	0	0	0	0	0

PM PERIOD COUNTS																	
Period	A	B	C	D	E	F	G	H	I	J	K	L	M	N	O	P	TOTAL
14:30-14:45	0	0	9	0	9	0	0	0	0	0	0	0	5	0	14	0	37
14:45-15:00	0	0	5	0	21	0	0	0	0	0	0	0	3	0	17	0	46
15:00-15:15	0	0	5	0	23	0	0	0	0	0	0	0	3	0	18	0	49
15:15-15:30	0	0	9	0	26	0	0	0	0	0	0	0	11	0	17	0	63
15:30-15:45	0	0	6	0	19	0	0	0	0	0	0	0	8	0	9	0	42
15:45-16:00	0	0	10	0	17	0	0	0	0	0	0	0	7	0	16	0	50
16:00-16:15	0	0	5	0	18	0	0	0	0	0	0	0	4	0	13	0	40
16:15-16:30	0	0	7	0	25	0	0	0	0	0	0	0	4	0	8	0	44

## Intersection Turning Movement Summary

<b>Intersection:</b>	Deer Valley Drive East/Queen Esther Drive	<b>Date:</b>	3-4-22, Fri
<b>North/South:</b>	Deer Valley Drive East	<b>Day of Week Adjustment:</b>	100.0%
<b>East/West:</b>	Queen Esther Drive	<b>Month of Year Adjustment:</b>	100.0%
<b>Jurisdiction:</b>	Park City	<b>Adjustment Station #:</b>	
<b>Project Title:</b>	Snow Park Development	<b>Growth Rate:</b>	0.0%
<b>Project No:</b>	UT20-2245	<b>Number of Years:</b>	0
<b>Weather:</b>			

AM PEAK HOUR PERIOD: **8:45-9:45**  
 AM PEAK 15 MINUTE PERIOD: **8:45-9:00**  
 AM PHF: **0.77**

NOON PEAK HOUR PERIOD:  
 NOON PEAK 15 MINUTE PERIOD:  
 NOON PHF: **####**

PM PEAK HOUR PERIOD: **15:30-16:30**  
 PM PEAK 15 MINUTE PERIOD: **16:00-16:15**  
 PM PHF: **0.94**

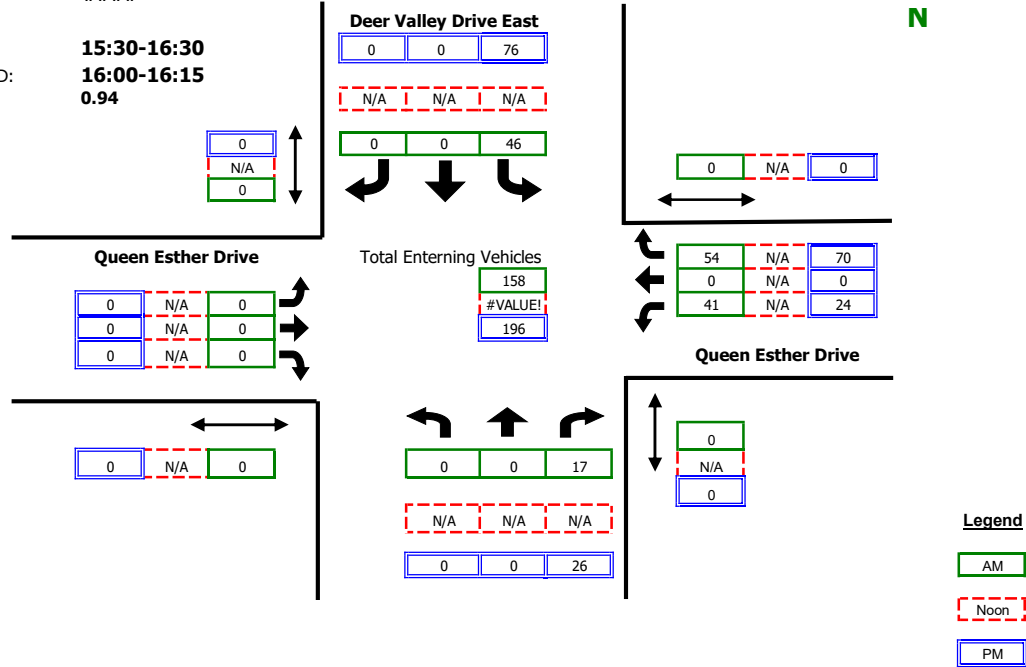

RAW COUNT SUMMARIES	Deer Valley Drive East Northbound				Deer Valley Drive East Southbound				Queen Esther Drive Eastbound				Queen Esther Drive Westbound			
	Left	Thru	Right	Peds	Left	Thru	Right	Peds	Left	Thru	Right	Peds	Left	Thru	Right	Peds

AM PERIOD COUNTS																	
Period	A	B	C	D	E	F	G	H	I	J	K	L	M	N	O	P	TOTAL
8:00-8:15	0	0	4	0	12	0	0	0	0	0	0	0	3	0	18	0	37
8:15-8:30	0	0	3	0	11	0	0	0	0	0	0	0	10	0	9	0	33
8:30-8:45	0	0	5	0	11	0	0	0	0	0	0	0	6	0	10	0	32
8:45-9:00	0	0	2	0	16	0	0	0	0	0	0	0	13	0	20	0	51
9:00-9:15	0	0	5	0	5	0	0	0	0	0	0	0	7	0	9	0	26
9:15-9:30	0	0	6	0	10	0	0	0	0	0	0	0	5	0	10	0	31
9:30-9:45	0	0	4	0	15	0	0	0	0	0	0	0	16	0	15	0	50
9:45-10:00	0	0	10	0	10	0	0	0	0	0	0	0	7	0	15	0	42

NOON PERIOD COUNTS																	
Period	A	B	C	D	E	F	G	H	I	J	K	L	M	N	O	P	TOTAL
14:00-14:15	0	0	0	0	0	0	0	0	0	0	0	0	0	0	0	0	0
14:15-14:30	0	0	0	0	0	0	0	0	0	0	0	0	0	0	0	0	0
14:30-14:45	0	0	0	0	0	0	0	0	0	0	0	0	0	0	0	0	0
14:45-15:00	0	0	0	0	0	0	0	0	0	0	0	0	0	0	0	0	0
15:00-15:15	0	0	0	0	0	0	0	0	0	0	0	0	0	0	0	0	0
15:15-15:30	0	0	0	0	0	0	0	0	0	0	0	0	0	0	0	0	0
15:30-15:45	0	0	0	0	0	0	0	0	0	0	0	0	0	0	0	0	0
15:45-14:00	0	0	0	0	0	0	0	0	0	0	0	0	0	0	0	0	0

PM PERIOD COUNTS																	
Period	A	B	C	D	E	F	G	H	I	J	K	L	M	N	O	P	TOTAL
14:30-14:45	0	0	6	0	14	0	0	0	0	0	0	0	5	0	9	0	34
14:45-15:00	0	0	8	0	19	0	0	0	0	0	0	0	6	0	23	0	56
15:00-15:15	0	0	8	0	11	0	0	0	0	0	0	0	8	0	18	0	45
15:15-15:30	0	0	8	0	16	0	0	0	0	0	0	0	7	0	15	0	46
15:30-15:45	0	0	2	0	10	0	0	0	0	0	0	0	8	0	21	0	41
15:45-16:00	0	0	7	0	26	0	0	0	0	0	0	0	3	0	15	0	51
16:00-16:15	0	0	7	0	18	0	0	0	0	0	0	0	7	0	20	0	52
16:15-16:30	0	0	10	0	22	0	0	0	0	0	0	0	6	0	14	0	52



## Intersection Turning Movement Summary

<b>Intersection:</b>	Deer Valley Drive East/Queen Esther Drive	<b>Date:</b>	3-5-22, Sat
<b>North/South:</b>	Deer Valley Drive East	<b>Day of Week Adjustment:</b>	100.0%
<b>East/West:</b>	Queen Esther Drive	<b>Month of Year Adjustment:</b>	100.0%
<b>Jurisdiction:</b>	Park City	<b>Adjustment Station #:</b>	
<b>Project Title:</b>	Snow Park Development	<b>Growth Rate:</b>	0.0%
<b>Project No:</b>	UT20-2245	<b>Number of Years:</b>	0
<b>Weather:</b>			

AM PEAK HOUR PERIOD: **8:45-9:45**  
 AM PEAK 15 MINUTE PERIOD: **8:45-9:00**  
 AM PHF: **0.86**

NOON PEAK HOUR PERIOD:  
 NOON PEAK 15 MINUTE PERIOD:  
 NOON PHF: **####**

PM PEAK HOUR PERIOD: **15:30-16:30**  
 PM PEAK 15 MINUTE PERIOD: **16:15-16:30**  
 PM PHF: **0.68**

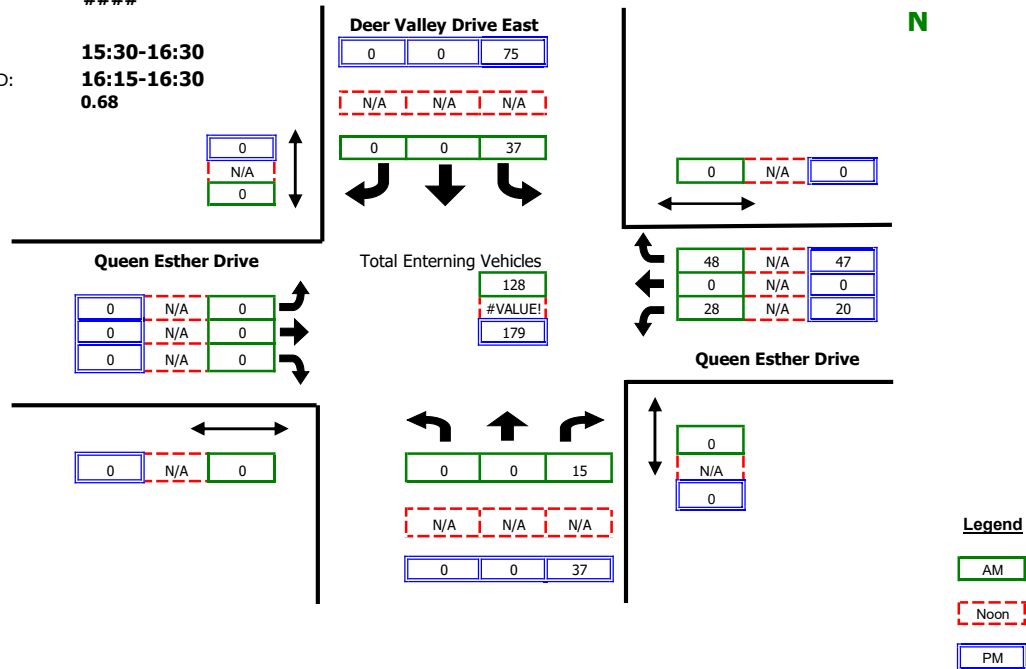

RAW COUNT SUMMARIES	Deer Valley Drive East Northbound				Deer Valley Drive East Southbound				Queen Esther Drive Eastbound				Queen Esther Drive Westbound			
	Left	Thru	Right	Peds	Left	Thru	Right	Peds	Left	Thru	Right	Peds	Left	Thru	Right	Peds

AM PERIOD COUNTS																	
Period	A	B	C	D	E	F	G	H	I	J	K	L	M	N	O	P	TOTAL
8:00-8:15	0	0	6	0	10	0	0	0	0	0	0	0	4	0	4	0	24
8:15-8:30	0	0	1	0	7	0	0	0	0	0	0	0	10	0	4	0	22
8:30-8:45	0	0	7	0	6	0	0	0	0	0	0	0	10	0	10	0	33
8:45-9:00	0	0	5	0	12	0	0	0	0	0	0	0	10	0	10	0	37
9:00-9:15	0	0	4	0	9	0	0	0	0	0	0	0	6	0	10	0	29
9:15-9:30	0	0	3	0	10	0	0	0	0	0	0	0	4	0	9	0	26
9:30-9:45	0	0	3	0	6	0	0	0	0	0	0	0	8	0	19	0	36
9:45-10:00	0	0	4	0	10	0	0	0	0	0	0	0	7	0	9	0	30

NOON PERIOD COUNTS																	
Period	A	B	C	D	E	F	G	H	I	J	K	L	M	N	O	P	TOTAL
14:00-14:15	0	0	0	0	0	0	0	0	0	0	0	0	0	0	0	0	0
14:15-14:30	0	0	0	0	0	0	0	0	0	0	0	0	0	0	0	0	0
14:30-14:45	0	0	0	0	0	0	0	0	0	0	0	0	0	0	0	0	0
14:45-15:00	0	0	0	0	0	0	0	0	0	0	0	0	0	0	0	0	0
15:00-15:15	0	0	0	0	0	0	0	0	0	0	0	0	0	0	0	0	0
15:15-15:30	0	0	0	0	0	0	0	0	0	0	0	0	0	0	0	0	0
15:30-15:45	0	0	0	0	0	0	0	0	0	0	0	0	0	0	0	0	0
15:45-14:00	0	0	0	0	0	0	0	0	0	0	0	0	0	0	0	0	0

PM PERIOD COUNTS																	
Period	A	B	C	D	E	F	G	H	I	J	K	L	M	N	O	P	TOTAL
14:30-14:45	0	0	7	0	23	0	0	0	0	0	0	0	4	0	10	0	44
14:45-15:00	0	0	4	0	16	0	0	0	0	0	0	0	7	0	15	0	42
15:00-15:15	0	0	2	0	9	0	0	0	0	0	0	0	6	0	7	0	24
15:15-15:30	0	0	4	0	12	0	0	0	0	0	0	0	2	0	11	0	29
15:30-15:45	0	0	6	0	14	0	0	0	0	0	0	0	7	0	9	0	36
15:45-16:00	0	0	5	0	14	0	0	0	0	0	0	0	4	0	11	0	34
16:00-16:15	0	0	11	0	16	0	0	0	0	0	0	0	6	0	10	0	43
16:15-16:30	0	0	15	0	31	0	0	0	0	0	0	0	3	0	17	0	66

## Intersection Turning Movement Summary

<b>Intersection:</b>	<b>Solamere Drive/Deer Valley Drive East</b>	<b>Date:</b>	<b>3-3-22, Thu</b>
<b>North/South:</b>	<b>Solamere Drive</b>	<b>Day of Week Adjustment:</b>	<b>100.0%</b>
<b>East/West:</b>	<b>Deer Valley Drive East</b>	<b>Month of Year Adjustment:</b>	<b>100.0%</b>
<b>Jurisdiction:</b>	<b>Park City</b>	<b>Adjustment Station #:</b>	
<b>Project Title:</b>	<b>Snow Park Development</b>	<b>Growth Rate:</b>	<b>0.0%</b>
<b>Project No:</b>	<b>UT20-2245</b>	<b>Number of Years:</b>	<b>0</b>
<b>Weather:</b>			

AM PEAK HOUR PERIOD: **8:30-9:30**  
 AM PEAK 15 MINUTE PERIOD: **8:30-8:45**  
 AM PHF: **0.83**

NOON PEAK HOUR PERIOD:  
 NOON PEAK 15 MINUTE PERIOD:  
 NOON PHF: **####**

PM PEAK HOUR PERIOD: **15:30-16:30**  
 PM PEAK 15 MINUTE PERIOD: **15:30-15:45**  
 PM PHF: **0.96**

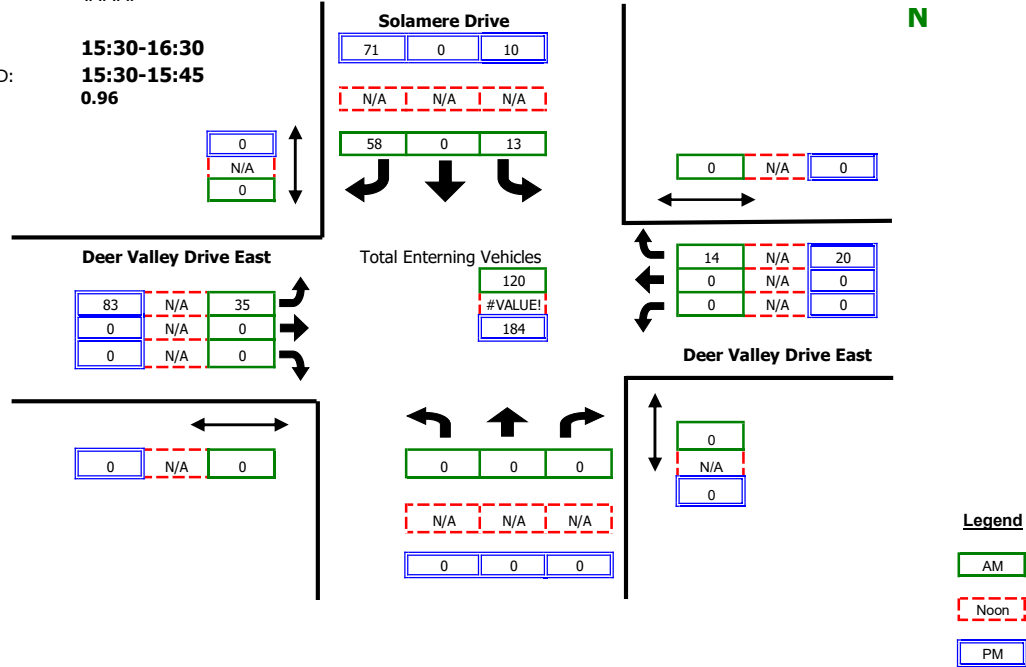

RAW COUNT SUMMARIES	Solamere Drive Northbound				Solamere Drive Southbound				Deer Valley Drive East Eastbound				Deer Valley Drive East Westbound			
	Left	Thru	Right	Peds	Left	Thru	Right	Peds	Left	Thru	Right	Peds	Left	Thru	Right	Peds

AM PERIOD COUNTS																	
Period	A	B	C	D	E	F	G	H	I	J	K	L	M	N	O	P	TOTAL
8:00-8:15	0	0	0	0	4	0	7	0	11	0	0	0	0	0	0	0	22
8:15-8:30	0	0	0	0	2	0	10	0	10	0	0	0	0	0	1	0	23
8:30-8:45	0	0	0	0	2	0	24	0	7	0	0	0	0	0	3	0	36
8:45-9:00	0	0	0	0	4	0	12	0	9	0	0	0	0	0	3	0	28
9:00-9:15	0	0	0	0	3	0	12	0	7	0	0	0	0	0	5	0	27
9:15-9:30	0	0	0	0	4	0	10	0	12	0	0	0	0	0	3	0	29
9:30-9:45	0	0	0	0	1	0	10	0	17	0	0	0	0	0	3	0	31
9:45-10:00	0	0	0	0	4	0	8	0	9	0	0	0	0	0	4	0	25

NOON PERIOD COUNTS																	
Period	A	B	C	D	E	F	G	H	I	J	K	L	M	N	O	P	TOTAL
14:00-14:15	0	0	0	0	0	0	0	0	0	0	0	0	0	0	0	0	0
14:15-14:30	0	0	0	0	0	0	0	0	0	0	0	0	0	0	0	0	0
14:30-14:45	0	0	0	0	0	0	0	0	0	0	0	0	0	0	0	0	0
14:45-15:00	0	0	0	0	0	0	0	0	0	0	0	0	0	0	0	0	0
15:00-15:15	0	0	0	0	0	0	0	0	0	0	0	0	0	0	0	0	0
15:15-15:30	0	0	0	0	0	0	0	0	0	0	0	0	0	0	0	0	0
15:30-15:45	0	0	0	0	0	0	0	0	0	0	0	0	0	0	0	0	0
15:45-14:00	0	0	0	0	0	0	0	0	0	0	0	0	0	0	0	0	0

PM PERIOD COUNTS																	
Period	A	B	C	D	E	F	G	H	I	J	K	L	M	N	O	P	TOTAL
14:30-14:45	0	0	0	0	3	0	23	0	16	0	0	0	0	0	6	0	48
14:45-15:00	0	0	0	0	2	0	17	0	16	0	0	0	0	0	4	0	39
15:00-15:15	0	0	0	0	1	0	20	0	19	0	0	0	0	0	3	0	43
15:15-15:30	0	0	0	0	5	0	17	0	18	0	0	0	0	0	7	0	47
15:30-15:45	0	0	0	0	3	0	24	0	14	0	0	0	0	0	7	0	48
15:45-16:00	0	0	0	0	2	0	15	0	25	0	0	0	0	0	2	0	44
16:00-16:15	0	0	0	0	5	0	15	0	20	0	0	0	0	0	4	0	44
16:15-16:30	0	0	0	0	0	0	17	0	24	0	0	0	0	0	7	0	48

## Intersection Turning Movement Summary

<b>Intersection:</b>	<b>Solamere Drive/Deer Valley Drive East</b>	<b>Date:</b>	<b>3-4-22, Fri</b>
<b>North/South:</b>	<b>Solamere Drive</b>	<b>Day of Week Adjustment:</b>	<b>100.0%</b>
<b>East/West:</b>	<b>Deer Valley Drive East</b>	<b>Month of Year Adjustment:</b>	<b>100.0%</b>
<b>Jurisdiction:</b>	<b>Park City</b>	<b>Adjustment Station #:</b>	
<b>Project Title:</b>	<b>Snow Park Development</b>	<b>Growth Rate:</b>	<b>0.0%</b>
<b>Project No:</b>	<b>UT20-2245</b>	<b>Number of Years:</b>	<b>0</b>
<b>Weather:</b>			

AM PEAK HOUR PERIOD: **8:45-9:45**  
 AM PEAK 15 MINUTE PERIOD: **9:15-9:30**  
 AM PHF: **0.93**

NOON PEAK HOUR PERIOD:  
 NOON PEAK 15 MINUTE PERIOD:  
 NOON PHF: **####**

PM PEAK HOUR PERIOD: **15:30-16:30**  
 PM PEAK 15 MINUTE PERIOD: **15:30-15:45**  
 PM PHF: **0.89**

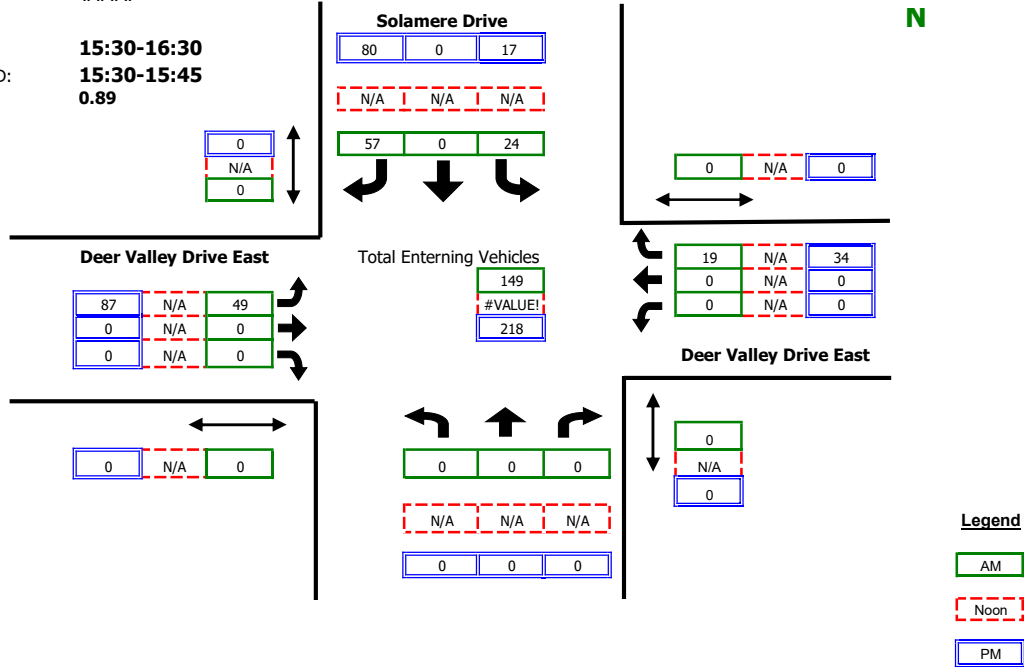

RAW COUNT SUMMARIES	Solamere Drive Northbound				Solamere Drive Southbound				Deer Valley Drive East Eastbound				Deer Valley Drive East Westbound			
	Left	Thru	Right	Peds	Left	Thru	Right	Peds	Left	Thru	Right	Peds	Left	Thru	Right	Peds

AM PERIOD COUNTS																		
Period	A	B	C	D	E	F	G	H	I	J	K	L	M	N	O	P	TOTAL	
8:00-8:15	0	0	0	0	2	0	6	0	6	0	0	0	0	0	0	1	0	15
8:15-8:30	0	0	0	0	5	0	13	0	9	0	0	0	0	0	2	0	29	
8:30-8:45	0	0	0	0	7	0	8	0	9	0	0	0	0	0	2	0	26	
8:45-9:00	0	0	0	0	8	0	11	0	11	0	0	0	0	0	7	0	37	
9:00-9:15	0	0	0	0	6	0	13	0	11	0	0	0	0	0	3	0	33	
9:15-9:30	0	0	0	0	4	0	17	0	16	0	0	0	0	0	3	0	40	
9:30-9:45	0	0	0	0	6	0	16	0	11	0	0	0	0	0	6	0	39	
9:45-10:00	0	0	0	0	4	0	19	0	10	0	0	0	0	0	2	0	35	

NOON PERIOD COUNTS																	
Period	A	B	C	D	E	F	G	H	I	J	K	L	M	N	O	P	TOTAL
14:00-14:15	0	0	0	0	0	0	0	0	0	0	0	0	0	0	0	0	0
14:15-14:30	0	0	0	0	0	0	0	0	0	0	0	0	0	0	0	0	0
14:30-14:45	0	0	0	0	0	0	0	0	0	0	0	0	0	0	0	0	0
14:45-15:00	0	0	0	0	0	0	0	0	0	0	0	0	0	0	0	0	0
15:00-15:15	0	0	0	0	0	0	0	0	0	0	0	0	0	0	0	0	0
15:15-15:30	0	0	0	0	0	0	0	0	0	0	0	0	0	0	0	0	0
15:30-15:45	0	0	0	0	0	0	0	0	0	0	0	0	0	0	0	0	0
15:45-14:00	0	0	0	0	0	0	0	0	0	0	0	0	0	0	0	0	0

PM PERIOD COUNTS																	
Period	A	B	C	D	E	F	G	H	I	J	K	L	M	N	O	P	TOTAL
14:30-14:45	0	0	0	0	0	0	21	0	15	0	0	0	0	0	1	0	37
14:45-15:00	0	0	0	0	6	0	11	0	20	0	0	0	0	0	1	0	38
15:00-15:15	0	0	0	0	2	0	16	0	17	0	0	0	0	0	7	0	42
15:15-15:30	0	0	0	0	4	0	15	0	19	0	0	0	0	0	1	0	39
15:30-15:45	0	0	0	0	5	0	24	0	20	0	0	0	0	0	12	0	61
15:45-16:00	0	0	0	0	3	0	16	0	17	0	0	0	0	0	5	0	41
16:00-16:15	0	0	0	0	4	0	21	0	21	0	0	0	0	0	8	0	54
16:15-16:30	0	0	0	0	5	0	19	0	29	0	0	0	0	0	9	0	62

## Intersection Turning Movement Summary

<b>Intersection:</b>	<b>Solamere Drive/Deer Valley Drive East</b>	<b>Date:</b>	<b>3-5-22, Sat</b>
<b>North/South:</b>	<b>Solamere Drive</b>	<b>Day of Week Adjustment:</b>	<b>100.0%</b>
<b>East/West:</b>	<b>Deer Valley Drive East</b>	<b>Month of Year Adjustment:</b>	<b>100.0%</b>
<b>Jurisdiction:</b>	<b>Park City</b>	<b>Adjustment Station #:</b>	
<b>Project Title:</b>	<b>Snow Park Development</b>	<b>Growth Rate:</b>	<b>0.0%</b>
<b>Project No:</b>	<b>UT20-2245</b>	<b>Number of Years:</b>	<b>0</b>
<b>Weather:</b>			

AM PEAK HOUR PERIOD: **9:00-10:00**  
 AM PEAK 15 MINUTE PERIOD: **9:45-10:00**  
 AM PHF: **0.76**

NOON PEAK HOUR PERIOD:  
 NOON PEAK 15 MINUTE PERIOD:  
 NOON PHF: **####**

PM PEAK HOUR PERIOD: **15:30-16:30**  
 PM PEAK 15 MINUTE PERIOD: **15:30-15:45**  
 PM PHF: **1.29**

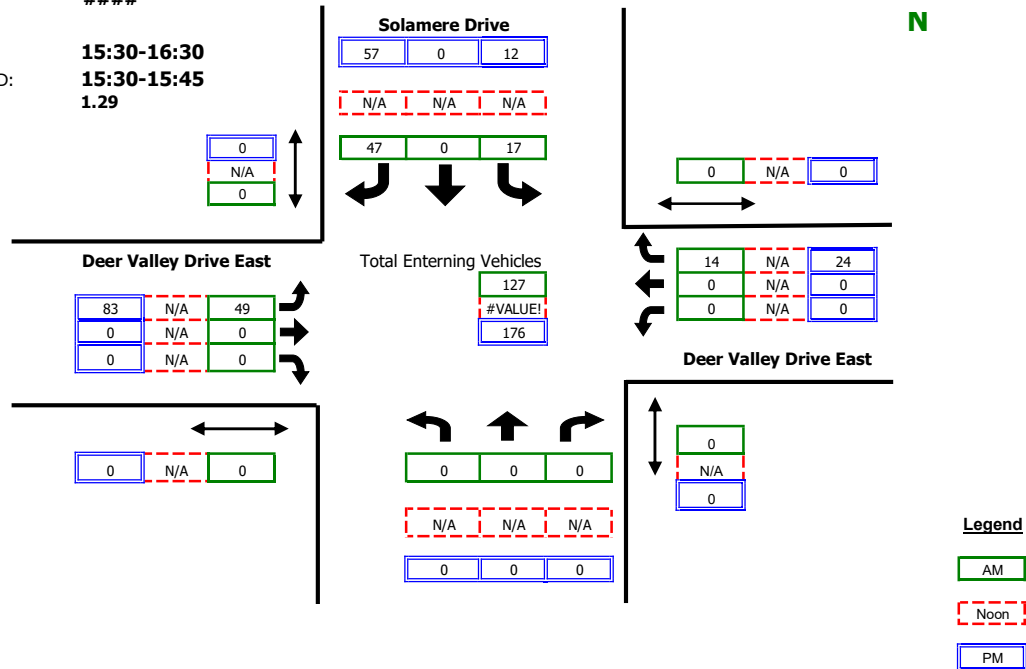

RAW COUNT SUMMARIES	Solamere Drive Northbound				Solamere Drive Southbound				Deer Valley Drive East Eastbound				Deer Valley Drive East Westbound			
	Left	Thru	Right	Peds	Left	Thru	Right	Peds	Left	Thru	Right	Peds	Left	Thru	Right	Peds

AM PERIOD COUNTS																		
Period	A	B	C	D	E	F	G	H	I	J	K	L	M	N	O	P	TOTAL	
8:00-8:15	0	0	0	0	2	0	12	0	4	0	0	0	0	0	0	2	0	20
8:15-8:30	0	0	0	0	5	0	6	0	5	0	0	0	0	0	0	1	0	17
8:30-8:45	0	0	0	0	9	0	15	0	8	0	0	0	0	0	0	0	0	32
8:45-9:00	0	0	0	0	6	0	15	0	4	0	0	0	0	0	0	6	0	31
9:00-9:15	0	0	0	0	5	0	4	0	8	0	0	0	0	0	0	2	0	19
9:15-9:30	0	0	0	0	1	0	12	0	13	0	0	0	0	0	0	5	0	31
9:30-9:45	0	0	0	0	8	0	9	0	14	0	0	0	0	0	0	4	0	35
9:45-10:00	0	0	0	0	3	0	22	0	14	0	0	0	0	0	0	3	0	42

NOON PERIOD COUNTS																		
Period	A	B	C	D	E	F	G	H	I	J	K	L	M	N	O	P	TOTAL	
14:00-14:15	0	0	0	0	0	0	0	0	0	0	0	0	0	0	0	0	0	0
14:15-14:30	0	0	0	0	0	0	0	0	0	0	0	0	0	0	0	0	0	0
14:30-14:45	0	0	0	0	0	0	0	0	0	0	0	0	0	0	0	0	0	0
14:45-15:00	0	0	0	0	0	0	0	0	0	0	0	0	0	0	0	0	0	0
15:00-15:15	0	0	0	0	0	0	0	0	0	0	0	0	0	0	0	0	0	0
15:15-15:30	0	0	0	0	0	0	0	0	0	0	0	0	0	0	0	0	0	0
15:30-15:45	0	0	0	0	0	0	0	0	0	0	0	0	0	0	0	0	0	0
15:45-14:00	0	0	0	0	0	0	0	0	0	0	0	0	0	0	0	0	0	0

PM PERIOD COUNTS																		
Period	A	B	C	D	E	F	G	H	I	J	K	L	M	N	O	P	TOTAL	
14:30-14:45	0	0	0	0	4	0	9	0	17	0	0	0	0	0	0	6	0	36
14:45-15:00	0	0	0	0	3	0	12	0	2	0	0	0	0	0	2	0	19	
15:00-15:15	0	0	0	0	3	0	8	0	7	0	0	0	0	0	7	0	25	
15:15-15:30	0	0	0	0	2	0	11	0	16	0	0	0	0	0	1	0	30	
15:30-15:45	0	0	0	0	2	0	11	0	17	0	0	0	0	0	4	0	34	
15:45-16:00	0	0	0	0	5	0	13	0	20	0	0	0	0	0	10	0	48	
16:00-16:15	0	0	0	0	3	0	15	0	25	0	0	0	0	0	9	0	52	
16:15-16:30	0	0	0	0	2	0	18	0	21	0	0	0	0	0	1	0	42	

MXD+ Vehicle Trip Generation Reduction Percent			
	Daily	AM Peak Hour	PM Peak Hour
Internal Capture	1.9%	3.7%	10.6%
Shift to Transit	3%	1.9%	2.9%
Shift to Walk/Bike	4.6%	5.6%	3.4%

**Advanced MXD+ Results**

Predicted Probabilities	Daily			AM			PM		
	HBW	HBO	NHB	HBW	HBO	NHB	HBW	HBO	NHB
<b>Productions</b>									
Internal Capture	4.35%	1.53%	1.45%	5.00%	2.88%	1.52%	21.06%	7.42%	7.04%
Walking External	2.59%	6.40%	0.30%	3.11%	8.32%	0.30%	2.59%	6.40%	0.30%
Transit External	0.25%	3.38%	4.43%	0.35%	3.72%	4.43%	0.35%	3.38%	4.43%
<b>Attractions</b>									
Internal Capture	4.28%	1.51%	1.45%	5.00%	2.88%	1.52%	21.06%	7.42%	7.04%
Walking External	2.56%	6.38%	0.30%	3.07%	7.66%	0.30%	2.56%	6.38%	0.30%
Transit External	0.25%	3.35%	4.44%	0.34%	4.69%	6.21%	0.34%	3.35%	4.44%

Number of Trips	Daily			AM			PM		
	HBW	HBO	NHB	HBW	HBO	NHB	HBW	HBO	NHB
<b>Productions</b>									
Internal Capture	7	9	2	1	1	0	4	5	2
Walking External	5	35	0	1	2	0	0	2	0
Transit External	0	18	8	0	1	0	0	1	1
<b>Attractions</b>									
Internal Capture	7	9	2	1	1	0	4	5	2
Walking External	2	43	1	0	3	0	0	5	0
Transit External	0	23	9	0	1	0	0	3	1

**SimTraffic Post-Processor**  
**Average Results from 10 Runs**  
**Volume and Delay by Movement**

**Snow Park Village**  
**Existing**  
**AM Peak Hour**

**Intersection 3**                      **Deer Valley Drive East/Queen Esther Drive**                      **Side-street Stop**

Direction	Movement	Demand Volume (vph)	Served Volume (vph)		Total Delay (sec/veh)		
			Average	Percent	Average	Std. Dev.	LOS
NB	Left Turn						
	Through	70	74	105.4%	0.3	0.2	A
	Right Turn	17	19	112.4%	0.3	0.6	A
	Subtotal	87	93	106.8%	0.3	0.2	A
SB	Left Turn	50	50	99.4%	4.1	0.3	A
	Through	116	116	99.6%	0.9	0.3	A
	Right Turn						
	Subtotal	166	165	99.5%	1.8	0.4	A
EB	Left Turn						
	Through						
	Right Turn						
	Subtotal						
WB	Left Turn	20	18	91.0%	5.8	1.2	A
	Through						
	Right Turn	55	56	101.6%	5.2	0.6	A
	Subtotal	75	74	98.8%	5.4	0.5	A
<b>Total</b>		<b>328</b>	<b>332</b>	<b>101.3%</b>	<b>2.3</b>	<b>0.3</b>	<b>A</b>

**Intersection 4**                      **Solamere Drive/Deer Valley Drive East**                      **Side-street Stop**

Direction	Movement	Demand Volume (vph)	Served Volume (vph)		Total Delay (sec/veh)		
			Average	Percent	Average	Std. Dev.	LOS
NB	Left Turn						
	Through						
	Right Turn						
	Subtotal						
SB	Left Turn	24	23	95.4%	6.8	2.3	A
	Through						
	Right Turn	57	60	104.6%	5.8	0.4	A
	Subtotal	81	83	101.9%	5.9	0.4	A
EB	Left Turn	49	49	100.0%	4.2	0.8	A
	Through	142	144	101.1%	1.3	0.4	A
	Right Turn						
	Subtotal	191	193	100.8%	2.0	0.5	A
WB	Left Turn						
	Through	106	108	101.7%	1.1	0.2	A
	Right Turn	19	21	110.0%	1.3	0.6	A
	Subtotal	125	129	103.0%	1.1	0.2	A
<b>Total</b>		<b>397</b>	<b>404</b>	<b>101.7%</b>	<b>2.6</b>	<b>0.2</b>	<b>A</b>



**SimTraffic Post-Processor**  
**Average Results from 10 Runs**  
**Volume and Delay by Movement**

**Snow Park Village**  
**Existing**  
**AM Peak Hour**

**Intersection 5**                      **Deer Valley Drive West/Deer Valley Drive East**                      **Side-street Stop**

Direction	Movement	Demand Volume (vph)	Served Volume (vph)		Total Delay (sec/veh)		
			Average	Percent	Average	Std. Dev.	LOS
NB	Left Turn						
	Through	147	148	100.6%	1.1	0.6	A
	Right Turn	15	15	98.7%	1.0	1.7	A
	Subtotal	162	163	100.4%	1.1	0.5	A
SB	Left Turn	176	176	100.2%	5.3	0.9	A
	Through	627	645	102.9%	3.7	0.6	A
	Right Turn						
	Subtotal	803	822	102.3%	4.0	0.6	A
EB	Left Turn						
	Through						
	Right Turn						
	Subtotal						
WB	Left Turn	7	7	97.1%	15.3	8.3	C
	Through						
	Right Turn	156	161	103.2%	4.2	0.9	A
	Subtotal	163	168	102.9%	4.9	0.8	A
<b>Total</b>		<b>1,128</b>	<b>1,152</b>	<b>102.1%</b>	<b>3.8</b>	<b>0.5</b>	<b>A</b>

**Intersection 7**                      **Deer Valley Drive/Bonanza Drive**                      **Signal**

Direction	Movement	Demand Volume (vph)	Served Volume (vph)		Total Delay (sec/veh)		
			Average	Percent	Average	Std. Dev.	LOS
NB	Left Turn						
	Through	263	266	101.2%	13.0	2.4	B
	Right Turn	151	158	104.8%	3.7	0.8	A
	Subtotal	414	424	102.5%	9.5	1.7	A
SB	Left Turn	105	101	96.4%	12.9	1.8	B
	Through	631	635	100.7%	8.9	1.2	A
	Right Turn						
	Subtotal	736	737	100.1%	9.4	1.1	A
EB	Left Turn						
	Through						
	Right Turn						
	Subtotal						
WB	Left Turn	553	558	101.0%	15.8	1.5	B
	Through						
	Right Turn	198	196	98.7%	5.4	1.5	A
	Subtotal	751	754	100.4%	13.0	1.5	B
<b>Total</b>		<b>1,901</b>	<b>1,915</b>	<b>100.7%</b>	<b>10.8</b>	<b>1.0</b>	<b>B</b>

**SimTraffic Post-Processor**  
**Average Results from 10 Runs**  
**Volume and Delay by Movement**

**Snow Park Village**  
**Existing**  
**AM Peak Hour**

**Intersection 8**

**SR-224-Park Avenue/Empire Avenue-Deer Valley Drive**

**Signal**

Direction	Movement	Demand Volume (vph)	Served Volume (vph)		Total Delay (sec/veh)		
			Average	Percent	Average	Std. Dev.	LOS
NB	Left Turn	36	35	96.1%	32.0	10.4	C
	Through	191	196	102.4%	52.3	3.8	D
	Right Turn	67	74	110.0%	17.5	6.3	B
	Subtotal	294	304	103.3%	42.7	4.9	D
SB	Left Turn	477	429	90.0%	206.7	15.7	F
	Through	169	154	90.8%	173.8	18.6	F
	Right Turn	901	853	94.6%	62.6	9.2	E
	Subtotal	1,547	1,436	92.8%	117.7	10.8	F
EB	Left Turn	320	316	98.7%	40.5	6.2	D
	Through	172	175	101.7%	26.9	8.7	C
	Right Turn	16	17	104.4%	19.7	18.3	B
	Subtotal	508	508	99.9%	35.2	5.4	D
WB	Left Turn	50	49	98.2%	53.8	9.2	D
	Through	253	281	110.9%	42.0	6.4	D
	Right Turn	215	215	99.9%	8.4	1.3	A
	Subtotal	518	545	105.1%	29.9	4.1	C
Total		2,867	2,791	97.4%	77.1	4.5	E

**Intersection 9**

**Monitor Drive-Bonanza Drive/SR-248**

**Signal**

Direction	Movement	Demand Volume (vph)	Served Volume (vph)		Total Delay (sec/veh)		
			Average	Percent	Average	Std. Dev.	LOS
NB	Left Turn	64	64	99.8%	22.0	4.6	C
	Through	28	30	106.4%	23.3	7.8	C
	Right Turn	101	100	98.9%	3.2	0.9	A
	Subtotal	193	194	100.3%	12.7	2.6	B
SB	Left Turn	54	54	100.6%	16.7	4.9	B
	Through	71	71	99.4%	26.4	5.1	C
	Right Turn	29	30	101.7%	4.3	1.0	A
	Subtotal	154	154	100.3%	18.4	3.0	B
EB	Left Turn	22	20	92.7%	12.9	3.6	B
	Through	230	234	101.6%	16.4	2.4	B
	Right Turn	95	98	103.2%	8.2	2.5	A
	Subtotal	347	352	101.5%	13.9	2.2	B
WB	Left Turn	287	284	98.9%	13.8	1.7	B
	Through	324	323	99.7%	7.7	1.7	A
	Right Turn	47	47	100.2%	3.7	1.9	A
	Subtotal	658	654	99.4%	10.0	1.3	B
Total		1,352	1,354	100.1%	12.4	1.5	B

# MOVEMENT SUMMARY

 Site: 101 [Existing AM]

Deer Valley Drive / Marsac Avenue Roundabout  
 Site Category: (None)  
 Roundabout

Movement Performance - Vehicles												
Mov ID	Turn	Demand Total	Flows HV %	Deg. Satn v/c	Average Delay sec	Level of Service	95% Back of Queue Vehicles veh	Distance ft	Prop. Queued	Effective Stop Rate	Aver. No. Cycles	Average Speed mph
South: Marsac Avenue												
3	L2	1	100.0	0.157	13.4	LOS B	0.6	14.5	0.63	0.63	0.63	33.7
8	T1	127	3.0	0.157	7.8	LOS A	0.6	14.5	0.63	0.63	0.63	34.3
18b	R3	62	3.0	0.157	7.8	LOS A	0.6	14.5	0.63	0.63	0.63	32.5
Approach		189	3.5	0.157	7.9	LOS A	0.6	14.5	0.63	0.63	0.63	33.7
SouthEast: RoadName												
3bx	L3	32	3.0	0.142	4.3	LOS A	0.5	14.7	0.29	0.17	0.29	35.9
3ax	L1	19	100.0	0.142	7.1	LOS A	0.5	14.7	0.29	0.17	0.29	34.5
18ax	R1	269	3.0	0.142	4.3	LOS A	0.6	15.2	0.29	0.17	0.29	35.6
Approach		320	8.8	0.142	4.4	LOS A	0.6	15.2	0.29	0.17	0.29	35.5
North: Deer Valley Drive												
7u	U	23	3.0	0.748	14.3	LOS B	8.6	221.4	0.52	0.26	0.52	30.4
7a	L1	804	3.0	0.748	14.3	LOS B	8.6	221.4	0.52	0.26	0.52	29.5
4	T1	378	3.0	0.748	8.1	LOS A	8.6	221.4	0.32	0.15	0.32	33.5
14	R2	12	100.0	0.204	7.2	LOS A	0.9	23.5	0.20	0.09	0.20	34.5
Approach		1217	3.9	0.748	12.3	LOS B	8.6	221.4	0.45	0.23	0.45	30.7
West: Transit Center												
5	L2	2	100.0	0.159	18.6	LOS C	0.3	11.7	0.68	0.68	0.68	29.6
12a	R1	23	100.0	0.159	18.6	LOS C	0.3	11.7	0.68	0.68	0.68	29.2
12	R2	13	100.0	0.159	18.6	LOS C	0.3	11.7	0.68	0.68	0.68	28.6
Approach		38	100.0	0.159	18.6	LOS C	0.3	11.7	0.68	0.68	0.68	29.0
All Vehicles		1765	6.9	0.748	10.5	LOS B	8.6	221.4	0.45	0.27	0.45	31.7

Site Level of Service (LOS) Method: Delay & v/c (HCM 6). Site LOS Method is specified in the Parameter Settings dialog (Site tab).

Roundabout LOS Method: Same as Sign Control.

Vehicle movement LOS values are based on average delay and v/c ratio (degree of saturation) per movement.

LOS F will result if v/c > 1 irrespective of movement delay value (does not apply for approaches and intersection).

Intersection and Approach LOS values are based on average delay for all movements (v/c not used as specified in HCM 6).

Roundabout Capacity Model: US HCM 6.

HCM Delay Formula option is used. Control Delay does not include Geometric Delay since Exclude Geometric Delay option applies.

Gap-Acceptance Capacity: Traditional M1.

HV (%) values are calculated for All Movement Classes of All Heavy Vehicle Model Designation.

**SimTraffic Post-Processor**  
**Average Results from 10 Runs**  
**Volume and Delay by Movement**

**Snow Park Village**  
**Existing**  
**PM Peak Hour**

**Intersection 3**                      **Deer Valley Drive East/Queen Esther Drive**                      **Side-street Stop**

Direction	Movement	Demand Volume (vph)	Served Volume (vph)		Total Delay (sec/veh)		
			Average	Percent	Average	Std. Dev.	LOS
NB	Left Turn						
	Through	293	298	101.6%	1.0	0.3	A
	Right Turn	30	33	111.3%	0.8	0.6	A
	Subtotal	323	331	102.5%	1.0	0.3	A
SB	Left Turn	85	81	95.4%	4.6	0.7	A
	Through	78	78	99.9%	1.2	0.4	A
	Right Turn						
	Subtotal	163	159	97.5%	2.9	0.5	A
EB	Left Turn						
	Through						
	Right Turn						
	Subtotal						
WB	Left Turn	29	29	100.7%	8.5	4.0	A
	Through						
	Right Turn	60	60	100.7%	6.0	0.9	A
	Subtotal	89	90	100.7%	6.6	1.4	A
<b>Total</b>		<b>575</b>	<b>580</b>	<b>100.8%</b>	<b>2.4</b>	<b>0.3</b>	<b>A</b>

**Intersection 4**                      **Solamere Drive/Deer Valley Drive East**                      **Side-street Stop**

Direction	Movement	Demand Volume (vph)	Served Volume (vph)		Total Delay (sec/veh)		
			Average	Percent	Average	Std. Dev.	LOS
NB	Left Turn						
	Through						
	Right Turn						
	Subtotal						
SB	Left Turn	17	19	112.4%	10.6	4.9	B
	Through						
	Right Turn	80	87	108.6%	7.1	2.1	A
	Subtotal	97	106	109.3%	7.7	2.2	A
EB	Left Turn	87	84	96.4%	5.3	0.9	A
	Through	146	138	94.7%	1.9	0.8	A
	Right Turn						
	Subtotal	233	222	95.3%	3.3	0.9	A
WB	Left Turn						
	Through	319	324	101.6%	1.2	0.2	A
	Right Turn	34	35	102.1%	1.0	0.5	A
	Subtotal	353	359	101.6%	1.2	0.2	A
<b>Total</b>		<b>683</b>	<b>687</b>	<b>100.6%</b>	<b>3.0</b>	<b>0.6</b>	<b>A</b>

**SimTraffic Post-Processor**  
**Average Results from 10 Runs**  
**Volume and Delay by Movement**

**Snow Park Village**  
**Existing**  
**PM Peak Hour**

**Intersection 5**                      **Deer Valley Drive West/Deer Valley Drive East**                      **Side-street Stop**

Direction	Movement	Demand Volume (vph)	Served Volume (vph)		Total Delay (sec/veh)		
			Average	Percent	Average	Std. Dev.	LOS
NB	Left Turn						
	Through	536	536	100.0%	3.4	0.3	A
	Right Turn	44	45	102.3%	3.2	1.3	A
	Subtotal	580	581	100.2%	3.4	0.3	A
SB	Left Turn	189	178	94.2%	8.5	2.0	A
	Through	204	205	100.6%	2.0	0.5	A
	Right Turn						
	Subtotal	393	383	97.5%	5.0	1.2	A
EB	Left Turn						
	Through						
	Right Turn						
	Subtotal						
WB	Left Turn	22	25	113.6%	39.3	37.1	E
	Through						
	Right Turn	377	382	101.2%	31.9	17.5	D
	Subtotal	399	407	101.9%	32.3	18.3	D
<b>Total</b>		<b>1,372</b>	<b>1,371</b>	<b>99.9%</b>	<b>12.2</b>	<b>5.4</b>	<b>B</b>

**Intersection 7**                      **Deer Valley Drive/Bonanza Drive**                      **Signal**

Direction	Movement	Demand Volume (vph)	Served Volume (vph)		Total Delay (sec/veh)		
			Average	Percent	Average	Std. Dev.	LOS
NB	Left Turn						
	Through	754	744	98.6%	29.8	7.7	C
	Right Turn	651	660	101.4%	20.8	8.4	C
	Subtotal	1,405	1,404	99.9%	25.6	7.8	C
SB	Left Turn	251	205	81.6%	19.8	1.7	B
	Through	460	431	93.6%	7.8	1.0	A
	Right Turn						
	Subtotal	711	635	89.4%	11.5	1.5	B
EB	Left Turn						
	Through						
	Right Turn						
	Subtotal						
WB	Left Turn	419	415	99.0%	23.4	4.0	C
	Through						
	Right Turn	129	129	99.8%	13.3	8.1	B
	Subtotal	548	544	99.2%	20.8	5.1	C
<b>Total</b>		<b>2,664</b>	<b>2,583</b>	<b>96.9%</b>	<b>21.2</b>	<b>5.2</b>	<b>C</b>

**SimTraffic Post-Processor**  
**Average Results from 10 Runs**  
**Volume and Delay by Movement**

**Snow Park Village**  
**Existing**  
**PM Peak Hour**

**Intersection 8 SR-224-Park Avenue/Empire Avenue-Deer Valley Drive Signal**

Direction	Movement	Demand Volume (vph)	Served Volume (vph)		Total Delay (sec/veh)		
			Average	Percent	Average	Std. Dev.	LOS
NB	Left Turn	35	34	96.3%	26.9	5.4	C
	Through	395	387	98.1%	48.2	4.5	D
	Right Turn	68	74	108.1%	26.7	8.6	C
	Subtotal	498	495	99.3%	44.0	4.2	D
SB	Left Turn	495	389	78.7%	208.5	18.4	F
	Through	363	286	78.8%	164.0	18.2	F
	Right Turn	364	294	80.9%	44.7	5.1	D
	Subtotal	1,222	970	79.4%	147.7	13.7	F
EB	Left Turn	633	526	83.1%	87.2	7.4	F
	Through	277	240	86.5%	70.2	16.8	E
	Right Turn	36	30	83.6%	65.0	22.4	E
	Subtotal	946	796	84.1%	81.4	10.3	F
WB	Left Turn	75	74	98.9%	73.7	14.1	E
	Through	239	285	119.4%	56.1	8.1	E
	Right Turn	640	624	97.6%	40.2	5.9	D
	Subtotal	954	984	103.1%	47.7	3.3	D
<b>Total</b>		<b>3,620</b>	<b>3,244</b>	<b>89.6%</b>	<b>84.3</b>	<b>3.4</b>	<b>F</b>

**Intersection 9 Monitor Drive-Bonanza Drive/SR-248 Signal**

Direction	Movement	Demand Volume (vph)	Served Volume (vph)		Total Delay (sec/veh)		
			Average	Percent	Average	Std. Dev.	LOS
NB	Left Turn	176	166	94.4%	34.5	8.0	C
	Through	89	93	104.5%	29.9	6.0	C
	Right Turn	479	455	95.0%	11.2	2.4	B
	Subtotal	744	714	96.0%	19.4	2.8	B
SB	Left Turn	90	88	98.2%	30.0	5.6	C
	Through	55	50	91.5%	34.5	7.9	C
	Right Turn	63	59	92.9%	5.5	1.2	A
	Subtotal	208	197	94.8%	23.9	3.5	C
EB	Left Turn	71	68	96.3%	15.8	3.5	B
	Through	584	589	100.9%	26.4	3.4	C
	Right Turn	149	148	99.3%	21.2	4.8	C
	Subtotal	804	805	100.2%	24.6	3.1	C
WB	Left Turn	218	216	99.1%	17.7	3.0	B
	Through	384	386	100.5%	11.3	2.2	B
	Right Turn	46	49	106.3%	6.8	4.2	A
	Subtotal	648	651	100.4%	13.1	1.7	B
<b>Total</b>		<b>2,404</b>	<b>2,367</b>	<b>98.5%</b>	<b>19.7</b>	<b>1.9</b>	<b>B</b>



# MOVEMENT SUMMARY

 Site: 101 [Existing PM]

Deer Valley Drive / Marsac Avenue Roundabout  
 Site Category: (None)  
 Roundabout

Movement Performance - Vehicles												
Mov ID	Turn	Demand Total	Flows HV %	Deg. Satn v/c	Average Delay sec	Level of Service	95% Back of Queue Vehicles veh	Distance ft	Prop. Queued	Effective Stop Rate	Aver. No. Cycles	Average Speed mph
South: Marsac Avenue												
3	L2	1	100.0	0.344	13.5	LOS B	1.5	38.8	0.64	0.65	0.68	32.9
8	T1	454	3.0	0.344	9.0	LOS A	1.5	38.8	0.64	0.65	0.68	33.8
18b	R3	62	3.0	0.344	9.0	LOS A	1.5	38.8	0.64	0.65	0.68	32.1
Approach		516	3.2	0.344	9.0	LOS A	1.5	38.8	0.64	0.65	0.68	33.6
SouthEast: RoadName												
3bx	L3	36	3.0	0.559	14.3	LOS B	3.7	97.6	0.74	0.91	1.23	31.7
3ax	L1	13	100.0	0.559	19.1	LOS C	3.7	97.6	0.74	0.91	1.23	30.4
18ax	R1	732	3.0	0.559	14.2	LOS B	3.8	98.4	0.75	0.91	1.23	31.0
Approach		782	4.6	0.559	14.3	LOS B	3.8	98.4	0.75	0.91	1.23	31.0
North: Deer Valley Drive												
7u	U	242	3.0	0.617	10.2	LOS B	5.3	134.5	0.36	0.17	0.36	31.9
7a	L1	368	3.0	0.617	10.2	LOS B	5.3	134.5	0.36	0.17	0.36	31.0
4	T1	398	3.0	0.617	7.1	LOS A	5.3	134.5	0.27	0.12	0.27	33.7
14	R2	6	100.0	0.169	6.8	LOS A	0.7	18.8	0.18	0.08	0.18	34.6
Approach		1014	3.6	0.617	9.0	LOS A	5.3	134.5	0.32	0.15	0.32	32.2
West: Transit Center												
5	L2	5	100.0	0.078	14.1	LOS B	0.1	5.8	0.61	0.61	0.61	31.0
12a	R1	12	100.0	0.078	14.1	LOS B	0.1	5.8	0.61	0.61	0.61	30.5
12	R2	5	100.0	0.078	14.1	LOS B	0.1	5.8	0.61	0.61	0.61	29.9
Approach		22	100.0	0.078	14.1	LOS B	0.1	5.8	0.61	0.61	0.61	30.5
All Vehicles		2334	4.8	0.617	10.8	LOS B	5.3	134.5	0.54	0.52	0.71	32.1

Site Level of Service (LOS) Method: Delay & v/c (HCM 6). Site LOS Method is specified in the Parameter Settings dialog (Site tab).

Roundabout LOS Method: Same as Sign Control.

Vehicle movement LOS values are based on average delay and v/c ratio (degree of saturation) per movement.

LOS F will result if v/c > 1 irrespective of movement delay value (does not apply for approaches and intersection).

Intersection and Approach LOS values are based on average delay for all movements (v/c not used as specified in HCM 6).

Roundabout Capacity Model: US HCM 6.

HCM Delay Formula option is used. Control Delay does not include Geometric Delay since Exclude Geometric Delay option applies.

Gap-Acceptance Capacity: Traditional M1.

HV (%) values are calculated for All Movement Classes of All Heavy Vehicle Model Designation.

SimTraffic Post-Processor  
Average Results from 10 Runs  
Volume and Delay by Movement

Snow Park Village  
Existing Plus Project  
AM Peak Hour

**Intersection 1**                      **Deer Valley Drive East/Doe Pass Road**                      **Signal**

Direction	Movement	Demand Volume (vph)	Served Volume (vph)		Total Delay (sec/veh)		LOS
			Average	Percent	Average	Std. Dev.	
NB	Left Turn	90	88	97.6%	1.5	1.1	A
	Through						
	Right Turn						
	Subtotal						
SB	Left Turn	164	165	100.7%	1.5	0.7	A
	Through						
	Right Turn						
	Subtotal						
EB	Left Turn	31	31	99.0%	8.0	1.2	A
	Through						
	Right Turn						
	Subtotal						
WB	Left Turn						
	Through						
	Right Turn						
	Subtotal						
Total		300	298	99.4%	2.1	0.7	A

**Intersection 2**                      **Deer Valley Drive West/Doe Pass Road**                      **Side-street Stop**

Direction	Movement	Demand Volume (vph)	Served Volume (vph)		Total Delay (sec/veh)		LOS
			Average	Percent	Average	Std. Dev.	
NB	Left Turn	20	20	100.5%	9.7	3.5	A
	Through						
	Right Turn						
	Subtotal						
SB	Left Turn						
	Through						
	Right Turn						
	Subtotal						
EB	Left Turn	640	644	100.6%	3.7	0.4	A
	Through						
	Right Turn						
	Subtotal						
WB	Left Turn	142	143	100.6%	0.3	0.1	A
	Through						
	Right Turn						
	Subtotal						
Total		822	824	100.2%	3.3	0.4	A

SimTraffic Post-Processor  
Average Results from 10 Runs  
Volume and Delay by Movement

Snow Park Village  
Existing Plus Project  
AM Peak Hour

**Intersection 3**                      **Deer Valley Drive East/Queen Esther Drive**                      **Side-street Stop**

Direction	Movement	Demand Volume (vph)	Served Volume (vph)		Total Delay (sec/veh)		
			Average	Percent	Average	Std. Dev.	LOS
NB	Left Turn						
	Through	149	150	100.3%	0.8	0.2	A
	Right Turn	17	16	93.5%	1.1	0.7	A
	Subtotal	166	165	99.6%	0.8	0.2	A
SB	Left Turn	50	49	97.2%	4.3	0.4	A
	Through	173	173	99.9%	1.1	0.3	A
	Right Turn						
	Subtotal	223	222	99.3%	1.7	0.4	A
EB	Left Turn						
	Through						
	Right Turn						
	Subtotal						
WB	Left Turn	20	21	105.0%	6.9	2.0	A
	Through						
	Right Turn	55	57	103.1%	5.8	0.9	A
	Subtotal	75	78	103.6%	6.1	0.9	A
<b>Total</b>		<b>464</b>	<b>465</b>	<b>100.1%</b>	<b>2.1</b>	<b>0.3</b>	<b>A</b>

**Intersection 4**                      **Solamere Drive/Deer Valley Drive East**                      **Side-street Stop**

Direction	Movement	Demand Volume (vph)	Served Volume (vph)		Total Delay (sec/veh)		
			Average	Percent	Average	Std. Dev.	LOS
NB	Left Turn						
	Through						
	Right Turn						
	Subtotal						
SB	Left Turn	24	23	95.0%	7.3	1.6	A
	Through						
	Right Turn	57	60	105.6%	5.9	0.9	A
	Subtotal	81	83	102.5%	6.3	1.1	A
EB	Left Turn	49	45	91.6%	4.0	0.6	A
	Through	199	197	99.0%	1.5	0.5	A
	Right Turn						
	Subtotal	248	242	97.5%	2.0	0.4	A
WB	Left Turn						
	Through	185	187	100.9%	0.9	0.2	A
	Right Turn	19	19	100.0%	0.5	0.5	A
	Subtotal	204	206	100.8%	0.8	0.2	A
<b>Total</b>		<b>533</b>	<b>531</b>	<b>99.5%</b>	<b>2.2</b>	<b>0.3</b>	<b>A</b>

SimTraffic Post-Processor  
Average Results from 10 Runs  
Volume and Delay by Movement

Snow Park Village  
Existing Plus Project  
AM Peak Hour

**Intersection 5**                      **Deer Valley Drive West/Deer Valley Drive East**                      **Side-street Stop**

Direction	Movement	Demand Volume (vph)	Served Volume (vph)		Total Delay (sec/veh)		
			Average	Percent	Average	Std. Dev.	LOS
NB	Left Turn						
	Through	147	149	101.2%	1.0	0.3	A
	Right Turn	15	15	96.7%	0.6	1.0	A
	Subtotal	162	163	100.7%	1.0	0.3	A
SB	Left Turn	233	226	97.0%	5.8	0.6	A
	Through	653	651	99.8%	3.7	0.3	A
	Right Turn						
	Subtotal	886	877	99.0%	4.2	0.3	A
EB	Left Turn						
	Through						
	Right Turn						
	Subtotal						
WB	Left Turn	7	6	85.7%	16.7	13.8	C
	Through						
	Right Turn	235	238	101.4%	5.4	1.0	A
	Subtotal	242	244	100.9%	5.7	1.2	A
Total		1,290	1,285	99.6%	4.1	0.3	A

**Intersection 7**                      **Deer Valley Drive/Bonanza Drive**                      **Signal**

Direction	Movement	Demand Volume (vph)	Served Volume (vph)		Total Delay (sec/veh)		
			Average	Percent	Average	Std. Dev.	LOS
NB	Left Turn						
	Through	302	303	100.4%	13.2	2.9	B
	Right Turn	167	169	101.3%	2.8	0.7	A
	Subtotal	469	472	100.7%	9.5	2.1	A
SB	Left Turn	105	93	88.6%	13.2	2.3	B
	Through	673	644	95.7%	9.2	1.8	A
	Right Turn						
	Subtotal	778	737	94.7%	9.8	1.8	A
EB	Left Turn						
	Through						
	Right Turn						
	Subtotal						
WB	Left Turn	570	569	99.8%	15.8	1.7	B
	Through						
	Right Turn	198	192	97.2%	4.9	0.6	A
	Subtotal	768	761	99.1%	12.9	1.5	B
Total		2,015	1,971	97.8%	11.0	1.5	B

SimTraffic Post-Processor  
Average Results from 10 Runs  
Volume and Delay by Movement

Snow Park Village  
Existing Plus Project  
AM Peak Hour

**Intersection 8**                      **SR-224-Park Avenue/Empire Avenue-Deer Valley Drive**                      **Signal**

Direction	Movement	Demand Volume (vph)	Served Volume (vph)		Total Delay (sec/veh)		LOS
			Average	Percent	Average	Std. Dev.	
NB	Left Turn	36	37	103.3%	35.5	8.5	D
	Through	191	189	99.1%	52.9	5.9	D
	Right Turn	67	68	101.9%	17.6	9.5	B
	Subtotal	294	295	100.2%	42.0	4.7	D
SB	Left Turn	519	434	83.7%	211.5	15.3	F
	Through	169	142	84.0%	177.8	16.0	F
	Right Turn	901	773	85.8%	57.3	10.5	E
	Subtotal	1,589	1,349	84.9%	120.8	10.5	F
EB	Left Turn	320	319	99.7%	39.0	6.0	D
	Through	172	170	98.9%	30.1	8.8	C
	Right Turn	16	18	111.9%	23.3	15.1	C
	Subtotal	508	507	99.8%	35.2	6.4	D
WB	Left Turn	50	51	101.6%	65.8	13.5	E
	Through	253	280	110.6%	47.2	5.2	D
	Right Turn	254	249	98.1%	9.1	2.4	A
	Subtotal	557	580	104.1%	33.0	4.6	C
Total		2,948	2,731	92.6%	77.9	3.3	E

**Intersection 9**                      **Monitor Drive-Bonanza Drive/SR-248**                      **Signal**

Direction	Movement	Demand Volume (vph)	Served Volume (vph)		Total Delay (sec/veh)		LOS
			Average	Percent	Average	Std. Dev.	
NB	Left Turn	64	59	92.5%	20.6	3.0	C
	Through	28	29	102.9%	24.3	4.9	C
	Right Turn	117	111	94.7%	3.2	0.6	A
	Subtotal	209	199	95.1%	10.9	1.4	B
SB	Left Turn	54	53	97.4%	19.8	2.9	B
	Through	71	73	103.1%	22.9	4.2	C
	Right Turn	29	28	96.2%	4.2	1.0	A
	Subtotal	154	154	99.8%	18.2	1.7	B
EB	Left Turn	22	22	99.5%	12.0	3.8	B
	Through	230	233	101.4%	15.7	2.1	B
	Right Turn	95	99	103.8%	7.5	2.0	A
	Subtotal	347	354	102.0%	13.3	2.2	B
WB	Left Turn	304	296	97.2%	13.4	1.6	B
	Through	324	336	103.6%	8.1	1.2	A
	Right Turn	47	51	108.9%	3.8	1.4	A
	Subtotal	675	682	101.1%	10.2	1.0	B
Total		1,385	1,389	100.3%	12.0	0.9	B

# MOVEMENT SUMMARY

 Site: 101 [Existing Plus Project AM]

Deer Valley Drive / Marsac Avenue Roundabout  
 Site Category: (None)  
 Roundabout

Movement Performance - Vehicles												
Mov ID	Turn	Demand Total	Flows HV %	Deg. Satn v/c	Average Delay sec	Level of Service	95% Back of Queue Vehicles	Distance ft	Prop. Queued	Effective Stop Rate	Aver. No. Cycles	Average Speed mph
South: Marsac Avenue												
3	L2	1	100.0	0.178	14.8	LOS B	0.6	16.2	0.65	0.65	0.65	33.2
8	T1	127	3.0	0.178	8.7	LOS A	0.6	16.3	0.65	0.65	0.65	33.9
18b	R3	70	3.0	0.178	8.7	LOS A	0.6	16.3	0.65	0.65	0.65	32.1
Approach		198	3.5	0.178	8.7	LOS A	0.6	16.3	0.65	0.65	0.65	33.2
SouthEast: RoadName												
3bx	L3	40	3.0	0.179	4.6	LOS A	0.7	19.1	0.30	0.18	0.30	35.8
3ax	L1	23	100.0	0.179	7.5	LOS A	0.7	19.1	0.30	0.18	0.30	34.3
18ax	R1	340	3.0	0.179	4.6	LOS A	0.8	19.8	0.30	0.18	0.30	35.4
Approach		404	8.6	0.179	4.8	LOS A	0.8	19.8	0.30	0.18	0.30	35.4
North: Deer Valley Drive												
7u	U	23	3.0	0.806	17.4	LOS C	10.7	273.9	0.67	0.37	0.67	29.2
7a	L1	880	3.0	0.806	17.4	LOS C	10.7	273.9	0.67	0.37	0.67	28.4
4	T1	378	3.0	0.806	8.8	LOS A	10.7	273.9	0.37	0.20	0.37	33.2
14	R2	12	100.0	0.220	7.4	LOS A	1.0	25.6	0.23	0.11	0.23	34.3
Approach		1293	3.9	0.806	14.8	LOS B	10.7	273.9	0.58	0.32	0.58	29.7
West: Transit Center												
5	L2	2	100.0	0.191	20.8	LOS C	0.3	13.9	0.71	0.71	0.71	28.8
12a	R1	28	100.0	0.191	20.8	LOS C	0.3	13.9	0.71	0.71	0.71	28.4
12	R2	13	100.0	0.191	20.8	LOS C	0.3	13.9	0.71	0.71	0.71	27.8
Approach		43	100.0	0.191	20.8	LOS C	0.3	13.9	0.71	0.71	0.71	28.2
All Vehicles		1937	6.9	0.806	12.2	LOS B	10.7	273.9	0.53	0.33	0.53	31.0

Site Level of Service (LOS) Method: Delay & v/c (HCM 6). Site LOS Method is specified in the Parameter Settings dialog (Site tab).

Roundabout LOS Method: Same as Sign Control.

Vehicle movement LOS values are based on average delay and v/c ratio (degree of saturation) per movement.

LOS F will result if v/c > 1 irrespective of movement delay value (does not apply for approaches and intersection).

Intersection and Approach LOS values are based on average delay for all movements (v/c not used as specified in HCM 6).

Roundabout Capacity Model: US HCM 6.

HCM Delay Formula option is used. Control Delay does not include Geometric Delay since Exclude Geometric Delay option applies.

Gap-Acceptance Capacity: Traditional M1.

HV (%) values are calculated for All Movement Classes of All Heavy Vehicle Model Designation.



SimTraffic Post-Processor  
Average Results from 10 Runs  
Volume and Delay by Movement

Snow Park Village  
Existing Plus Project  
PM Peak Hour

**Intersection 1**                      **Deer Valley Drive East/Doe Pass Road**                      **Signal**

Direction	Movement	Demand Volume (vph)	Served Volume (vph)		Total Delay (sec/veh)		LOS
			Average	Percent	Average	Std. Dev.	
NB	Left Turn	363	357	98.5%	1.3	0.7	A
	Through						
	Right Turn						
	Subtotal	363	357	98.5%	1.3	0.7	A
SB	Left Turn	132	137	103.5%	1.3	0.3	A
	Through						
	Right Turn						
	Subtotal	147	152	103.1%	1.2	0.4	A
EB	Left Turn	26	25	96.9%	7.9	1.1	A
	Through						
	Right Turn						
	Subtotal	26	25	96.9%	7.9	1.1	A
WB	Left Turn						
	Through						
	Right Turn						
	Subtotal						
<b>Total</b>		<b>536</b>	<b>534</b>	<b>99.6%</b>	<b>1.6</b>	<b>0.6</b>	<b>A</b>

**Intersection 2**                      **Deer Valley Drive West/Doe Pass Road**                      **Side-street Stop**

Direction	Movement	Demand Volume (vph)	Served Volume (vph)		Total Delay (sec/veh)		LOS
			Average	Percent	Average	Std. Dev.	
NB	Left Turn	20	22	109.0%	12.4	3.1	B
	Through						
	Right Turn						
	Subtotal	20	22	109.0%	12.4	3.1	B
SB	Left Turn						
	Through						
	Right Turn						
	Subtotal						
EB	Left Turn	220	225	102.0%	1.4	0.3	A
	Through						
	Right Turn						
	Subtotal	240	244	101.8%	1.4	0.3	A
WB	Left Turn	560	566	101.1%	2.4	0.1	A
	Through						
	Right Turn						
	Subtotal	560	566	101.1%	2.4	0.1	A
<b>Total</b>		<b>820</b>	<b>832</b>	<b>101.5%</b>	<b>2.4</b>	<b>0.2</b>	<b>A</b>

SimTraffic Post-Processor  
Average Results from 10 Runs  
Volume and Delay by Movement

Snow Park Village  
Existing Plus Project  
PM Peak Hour

**Intersection 3**                      **Deer Valley Drive East/Queen Esther Drive**                      **Side-street Stop**

Direction	Movement	Demand Volume (vph)	Served Volume (vph)		Total Delay (sec/veh)		
			Average	Percent	Average	Std. Dev.	LOS
NB	Left Turn						
	Through	393	393	100.1%	1.2	0.3	A
	Right Turn	30	32	106.0%	1.3	0.7	A
	Subtotal	423	425	100.5%	1.2	0.3	A
SB	Left Turn	85	82	96.1%	4.9	0.4	A
	Through	168	177	105.6%	1.6	0.6	A
	Right Turn						
	Subtotal	253	259	102.4%	2.7	0.6	A
EB	Left Turn						
	Through						
	Right Turn						
	Subtotal						
WB	Left Turn	29	27	91.7%	8.3	1.8	A
	Through						
	Right Turn	60	65	108.3%	6.7	0.8	A
	Subtotal	89	92	102.9%	7.3	0.6	A
Total		765	776	101.4%	2.5	0.3	A

**Intersection 4**                      **Solamere Drive/Deer Valley Drive East**                      **Side-street Stop**

Direction	Movement	Demand Volume (vph)	Served Volume (vph)		Total Delay (sec/veh)		
			Average	Percent	Average	Std. Dev.	LOS
NB	Left Turn						
	Through						
	Right Turn						
	Subtotal						
SB	Left Turn	17	18	107.6%	13.1	5.2	B
	Through						
	Right Turn	80	80	99.4%	8.2	1.8	A
	Subtotal	97	98	100.8%	9.0	2.0	A
EB	Left Turn	87	79	90.7%	6.1	1.1	A
	Through	236	240	101.5%	2.1	0.8	A
	Right Turn						
	Subtotal	323	318	98.6%	3.0	0.8	A
WB	Left Turn						
	Through	419	422	100.8%	1.2	0.2	A
	Right Turn	34	35	102.4%	1.0	0.6	A
	Subtotal	453	457	100.9%	1.2	0.1	A
Total		873	873	100.0%	2.7	0.4	A

SimTraffic Post-Processor  
Average Results from 10 Runs  
Volume and Delay by Movement

Snow Park Village  
Existing Plus Project  
PM Peak Hour

**Intersection 5**                      **Deer Valley Drive West/Deer Valley Drive East**                      **Side-street Stop**

Direction	Movement	Demand Volume (vph)	Served Volume (vph)		Total Delay (sec/veh)		
			Average	Percent	Average	Std. Dev.	LOS
NB	Left Turn						
	Through	536	546	101.9%	2.7	0.3	A
	Right Turn	44	45	102.5%	1.9	0.8	A
	Subtotal	580	592	102.0%	2.7	0.3	A
SB	Left Turn	279	272	97.4%	9.4	2.3	A
	Through	218	221	101.3%	1.9	0.4	A
	Right Turn						
	Subtotal	497	493	99.1%	6.1	1.4	A
EB	Left Turn						
	Through						
	Right Turn						
	Subtotal						
WB	Left Turn	22	23	105.5%	78.8	35.7	F
	Through						
	Right Turn	477	465	97.4%	78.8	38.6	F
	Subtotal	499	488	97.8%	78.8	38.5	F
<b>Total</b>		<b>1,576</b>	<b>1,572</b>	<b>99.7%</b>	<b>28.3</b>	<b>12.5</b>	<b>D</b>

**Intersection 7**                      **Deer Valley Drive/Bonanza Drive**                      **Signal**

Direction	Movement	Demand Volume (vph)	Served Volume (vph)		Total Delay (sec/veh)		
			Average	Percent	Average	Std. Dev.	LOS
NB	Left Turn						
	Through	804	792	98.5%	35.4	16.9	D
	Right Turn	671	687	102.4%	29.5	22.9	C
	Subtotal	1,475	1,479	100.3%	32.7	19.6	C
SB	Left Turn	251	197	78.6%	19.0	2.2	B
	Through	512	433	84.6%	8.5	1.6	A
	Right Turn						
	Subtotal	763	630	82.6%	11.8	1.3	B
EB	Left Turn						
	Through						
	Right Turn						
	Subtotal						
WB	Left Turn	440	434	98.7%	26.2	7.2	C
	Through						
	Right Turn	129	132	102.6%	12.4	5.0	B
	Subtotal	569	567	99.6%	23.1	6.6	C
<b>Total</b>		<b>2,807</b>	<b>2,676</b>	<b>95.3%</b>	<b>25.9</b>	<b>11.6</b>	<b>C</b>

SimTraffic Post-Processor  
Average Results from 10 Runs  
Volume and Delay by Movement

Snow Park Village  
Existing Plus Project  
PM Peak Hour

**Intersection 8**                      **SR-224-Park Avenue/Empire Avenue-Deer Valley Drive**                      **Signal**

Direction	Movement	Demand Volume (vph)	Served Volume (vph)		Total Delay (sec/veh)		LOS
			Average	Percent	Average	Std. Dev.	
NB	Left Turn	35	34	96.3%	33.4	9.2	C
	Through	395	388	98.3%	50.2	6.5	D
	Right Turn	68	70	102.2%	30.1	7.8	C
	Subtotal	498	491	98.7%	46.1	5.6	D
SB	Left Turn	547	388	70.9%	219.3	16.6	F
	Through	363	259	71.3%	173.1	10.9	F
	Right Turn	364	251	69.1%	49.7	7.7	D
	Subtotal	1,274	898	70.5%	157.9	13.8	F
EB	Left Turn	633	529	83.5%	83.1	5.9	F
	Through	277	238	86.0%	60.9	11.1	E
	Right Turn	36	33	92.2%	63.7	15.2	E
	Subtotal	946	800	84.6%	75.5	7.4	E
WB	Left Turn	75	71	94.9%	67.7	13.3	E
	Through	239	293	122.5%	46.6	7.8	D
	Right Turn	690	659	95.5%	50.5	4.9	D
	Subtotal	1,004	1,023	101.9%	50.7	4.7	D
<b>Total</b>		<b>3,722</b>	<b>3,213</b>	<b>86.3%</b>	<b>86.0</b>	<b>3.9</b>	<b>F</b>

**Intersection 9**                      **Monitor Drive-Bonanza Drive/SR-248**                      **Signal**

Direction	Movement	Demand Volume (vph)	Served Volume (vph)		Total Delay (sec/veh)		LOS
			Average	Percent	Average	Std. Dev.	
NB	Left Turn	176	177	100.7%	32.0	4.1	C
	Through	89	95	107.0%	33.6	4.2	C
	Right Turn	499	469	93.9%	11.1	2.5	B
	Subtotal	764	741	97.0%	19.3	1.9	B
SB	Left Turn	90	92	101.9%	27.3	6.9	C
	Through	55	52	94.5%	35.4	4.5	D
	Right Turn	63	66	104.3%	5.2	1.1	A
	Subtotal	208	209	100.7%	22.7	3.4	C
EB	Left Turn	71	69	96.6%	13.6	2.9	B
	Through	584	592	101.4%	25.6	2.6	C
	Right Turn	149	150	100.9%	19.0	4.5	B
	Subtotal	804	811	100.8%	23.4	2.4	C
WB	Left Turn	239	232	97.0%	20.4	2.7	C
	Through	384	393	102.4%	12.3	2.4	B
	Right Turn	46	46	100.4%	7.0	2.9	A
	Subtotal	669	671	100.3%	14.8	1.6	B
<b>Total</b>		<b>2,445</b>	<b>2,433</b>	<b>99.5%</b>	<b>19.7</b>	<b>1.4</b>	<b>B</b>

# MOVEMENT SUMMARY

 Site: 101 [Existing Plus Project PM]

Deer Valley Drive / Marsac Avenue Roundabout  
 Site Category: (None)  
 Roundabout

Movement Performance - Vehicles												
Mov ID	Turn	Demand Total	Flows HV %	Deg. Satn v/c	Average Delay sec	Level of Service	95% Back of Queue Vehicles veh	Distance ft	Prop. Queued	Effective Stop Rate	Aver. No. Cycles	Average Speed mph
South: Marsac Avenue												
3	L2	1	100.0	0.385	15.4	LOS C	1.8	47.1	0.68	0.73	0.84	32.3
8	T1	454	3.0	0.385	10.4	LOS B	1.8	47.1	0.68	0.73	0.84	33.1
18b	R3	72	3.0	0.385	10.4	LOS B	1.8	47.1	0.68	0.73	0.84	31.5
Approach		526	3.2	0.385	10.4	LOS B	1.8	47.1	0.68	0.73	0.84	32.9
SouthEast: RoadName												
3bx	L3	46	3.0	0.634	16.9	LOS C	4.9	129.2	0.78	1.00	1.44	30.6
3ax	L1	18	100.0	0.634	21.7	LOS C	4.9	129.2	0.78	1.00	1.44	29.3
18ax	R1	818	3.0	0.634	16.7	LOS C	5.1	130.4	0.79	1.00	1.44	29.9
Approach		883	5.0	0.634	16.8	LOS C	5.1	130.4	0.79	1.00	1.44	30.0
North: Deer Valley Drive												
7u	U	242	3.0	0.684	12.1	LOS B	6.6	168.0	0.47	0.25	0.47	31.1
7a	L1	458	3.0	0.684	12.1	LOS B	6.6	168.0	0.47	0.25	0.47	30.2
4	T1	398	3.0	0.684	7.7	LOS A	6.6	168.0	0.33	0.17	0.33	33.4
14	R2	6	100.0	0.187	7.1	LOS A	0.8	21.1	0.22	0.10	0.22	34.4
Approach		1104	3.5	0.684	10.5	LOS B	6.6	168.0	0.42	0.22	0.42	31.5
West: Transit Center												
5	L2	5	100.0	0.105	15.9	LOS C	0.2	7.7	0.65	0.65	0.65	30.4
12a	R1	17	100.0	0.105	15.9	LOS C	0.2	7.7	0.65	0.65	0.65	29.9
12	R2	5	100.0	0.105	15.9	LOS C	0.2	7.7	0.65	0.65	0.65	29.3
Approach		27	100.0	0.105	15.9	LOS C	0.2	7.7	0.65	0.65	0.65	29.9
All Vehicles		2540	5.0	0.684	12.7	LOS B	6.6	168.0	0.60	0.60	0.86	31.2

Site Level of Service (LOS) Method: Delay & v/c (HCM 6). Site LOS Method is specified in the Parameter Settings dialog (Site tab).

Roundabout LOS Method: Same as Sign Control.

Vehicle movement LOS values are based on average delay and v/c ratio (degree of saturation) per movement.

LOS F will result if v/c > 1 irrespective of movement delay value (does not apply for approaches and intersection).

Intersection and Approach LOS values are based on average delay for all movements (v/c not used as specified in HCM 6).

Roundabout Capacity Model: US HCM 6.

HCM Delay Formula option is used. Control Delay does not include Geometric Delay since Exclude Geometric Delay option applies.

Gap-Acceptance Capacity: Traditional M1.

HV (%) values are calculated for All Movement Classes of All Heavy Vehicle Model Designation.

**SimTraffic Post-Processor**  
**Average Results from 10 Runs**  
**Volume and Delay by Movement**

**Snow Park Village**  
**Existing Plus Project - Bus Option - Mitigated**  
**AM Peak Hour**

**Intersection 1**                      **Deer Valley Drive East/Doe Pass Road**                      **Signal**

Direction	Movement	Demand Volume (vph)	Served Volume (vph)		Total Delay (sec/veh)		LOS
			Average	Percent	Average	Std. Dev.	
NB	Left Turn	202	207	102.7%	13.1	1.6	B
	Through						
	Right Turn						
	Subtotal	202	207	102.7%	13.1	1.6	B
SB	Left Turn	329	334	101.6%	15.0	2.0	B
	Through						
	Right Turn						
	Subtotal	344	349	101.5%	14.9	1.8	B
EB	Left Turn	31	29	92.3%	29.1	6.8	C
	Through						
	Right Turn						
	Subtotal	31	29	92.3%	29.1	6.8	C
WB	Left Turn						
	Through						
	Right Turn						
	Subtotal						
<b>Total</b>		<b>577</b>	<b>585</b>	<b>101.4%</b>	<b>14.9</b>	<b>1.0</b>	<b>B</b>

**Intersection 2**                      **Deer Valley Drive West/Doe Pass Road**                      **Side-street Stop**

Direction	Movement	Demand Volume (vph)	Served Volume (vph)		Total Delay (sec/veh)		LOS
			Average	Percent	Average	Std. Dev.	
NB	Left Turn	20	19	94.0%	7.1	2.2	A
	Through						
	Right Turn						
	Subtotal	20	19	94.0%	7.1	2.2	A
SB	Left Turn						
	Through						
	Right Turn						
	Subtotal						
EB	Left Turn	475	484	101.9%	1.1	0.1	A
	Through						
	Right Turn						
	Subtotal	495	502	101.5%	1.1	0.1	A
WB	Left Turn	30	30	98.3%	0.9	0.2	A
	Through						
	Right Turn						
	Subtotal	30	30	98.3%	0.9	0.2	A
<b>Total</b>		<b>545</b>	<b>551</b>	<b>101.0%</b>	<b>1.3</b>	<b>0.2</b>	<b>A</b>



**SimTraffic Post-Processor**  
**Average Results from 10 Runs**  
**Volume and Delay by Movement**

**Snow Park Village**  
**Existing Plus Project - Bus Option - Mitigated**  
**AM Peak Hour**

**Intersection 3**                      **Deer Valley Drive East/Queen Esther Drive**                      **Side-street Stop**

Direction	Movement	Demand Volume (vph)	Served Volume (vph)		Total Delay (sec/veh)		
			Average	Percent	Average	Std. Dev.	LOS
NB	Left Turn						
	Through	261	267	102.4%	0.3	0.1	A
	Right Turn	17	16	92.9%	0.1	0.1	A
	Subtotal	278	283	101.8%	0.3	0.1	A
SB	Left Turn	50	50	99.8%	4.2	0.5	A
	Through	338	345	102.2%	0.5	0.1	A
	Right Turn						
	Subtotal	388	395	101.9%	1.0	0.2	A
EB	Left Turn						
	Through						
	Right Turn						
	Subtotal						
WB	Left Turn	20	21	102.5%	8.3	2.6	A
	Through						
	Right Turn	55	56	101.8%	6.1	0.7	A
	Subtotal	75	77	102.0%	6.5	0.7	A
<b>Total</b>		<b>741</b>	<b>755</b>	<b>101.8%</b>	<b>1.4</b>	<b>0.2</b>	<b>A</b>

**Intersection 4**                      **Solamere Drive/Deer Valley Drive East**                      **Side-street Stop**

Direction	Movement	Demand Volume (vph)	Served Volume (vph)		Total Delay (sec/veh)		
			Average	Percent	Average	Std. Dev.	LOS
NB	Left Turn						
	Through						
	Right Turn						
	Subtotal						
SB	Left Turn	24	24	101.7%	7.7	1.4	A
	Through						
	Right Turn	57	58	100.9%	6.7	0.8	A
	Subtotal	81	82	101.1%	7.0	0.7	A
EB	Left Turn	49	47	96.5%	6.0	1.3	A
	Through	364	368	101.1%	2.2	0.3	A
	Right Turn						
	Subtotal	413	415	100.6%	2.7	0.4	A
WB	Left Turn						
	Through	297	301	101.3%	0.4	0.1	A
	Right Turn	19	19	101.6%	0.3	0.3	A
	Subtotal	316	320	101.4%	0.4	0.1	A
<b>Total</b>		<b>810</b>	<b>818</b>	<b>100.9%</b>	<b>2.3</b>	<b>0.2</b>	<b>A</b>

**SimTraffic Post-Processor**  
**Average Results from 10 Runs**  
**Volume and Delay by Movement**

**Snow Park Village**  
**Existing Plus Project - Bus Option - Mitigated**  
**AM Peak Hour**

**Intersection 5**                      **Deer Valley Drive West/Deer Valley Drive East**                      **Signal**

Direction	Movement	Demand Volume (vph)	Served Volume (vph)		Total Delay (sec/veh)		LOS
			Average	Percent	Average	Std. Dev.	
NB	Left Turn						
	Through	35	32	92.0%	16.0	7.3	B
	Right Turn	15	15	100.0%	6.3	4.7	A
	Subtotal	50	47	94.4%	13.6	6.9	B
SB	Left Turn	398	399	100.2%	9.1	1.3	A
	Through	488	489	100.2%	6.4	0.9	A
	Right Turn						
	Subtotal	886	888	100.2%	7.6	0.8	A
EB	Left Turn						
	Through						
	Right Turn						
	Subtotal						
WB	Left Turn	10	11	114.0%	16.7	11.3	B
	Through						
	Right Turn	347	348	100.2%	4.1	0.4	A
	Subtotal	357	359	100.6%	4.5	0.4	A
<b>Total</b>		<b>1,293</b>	<b>1,294</b>	<b>100.1%</b>	<b>7.0</b>	<b>0.7</b>	<b>A</b>

**Intersection 7**                      **Deer Valley Drive/Bonanza Drive**                      **Signal**

Direction	Movement	Demand Volume (vph)	Served Volume (vph)		Total Delay (sec/veh)		LOS
			Average	Percent	Average	Std. Dev.	
NB	Left Turn						
	Through	302	306	101.2%	14.4	2.0	B
	Right Turn	167	166	99.5%	3.7	0.9	A
	Subtotal	469	472	100.6%	10.6	1.5	B
SB	Left Turn	105	94	89.0%	13.6	3.4	B
	Through	673	634	94.2%	8.8	1.8	A
	Right Turn						
	Subtotal	778	728	93.5%	9.4	1.7	A
EB	Left Turn						
	Through						
	Right Turn						
	Subtotal						
WB	Left Turn	570	574	100.7%	16.1	2.4	B
	Through						
	Right Turn	198	202	101.9%	6.1	1.2	A
	Subtotal	768	776	101.0%	13.4	2.1	B
<b>Total</b>		<b>2,015</b>	<b>1,975</b>	<b>98.0%</b>	<b>11.3</b>	<b>1.0</b>	<b>B</b>

**SimTraffic Post-Processor**  
**Average Results from 10 Runs**  
**Volume and Delay by Movement**

**Snow Park Village**  
**Existing Plus Project - Bus Option - Mitigated**  
**AM Peak Hour**

**Intersection 8 SR-224-Park Avenue/Empire Avenue-Deer Valley Drive Signal**

Direction	Movement	Demand Volume (vph)	Served Volume (vph)		Total Delay (sec/veh)		
			Average	Percent	Average	Std. Dev.	LOS
NB	Left Turn	36	37	103.9%	30.1	11.2	C
	Through	191	187	98.0%	48.4	4.6	D
	Right Turn	67	68	100.9%	13.0	7.2	B
	Subtotal	294	292	99.4%	37.4	4.2	D
SB	Left Turn	519	435	83.7%	213.2	12.3	F
	Through	169	147	87.2%	177.6	19.9	F
	Right Turn	901	775	86.0%	49.4	14.7	D
	Subtotal	1,589	1,357	85.4%	118.5	5.8	F
EB	Left Turn	320	324	101.2%	40.6	4.7	D
	Through	172	168	97.5%	26.0	3.6	C
	Right Turn	16	16	102.5%	15.1	8.3	B
	Subtotal	508	508	100.0%	35.2	3.3	D
WB	Left Turn	50	51	102.2%	67.0	26.5	E
	Through	253	286	113.1%	49.7	8.4	D
	Right Turn	254	252	99.1%	10.1	3.0	B
	Subtotal	557	589	105.7%	33.5	7.8	C
Total		2,948	2,746	93.1%	75.7	4.0	E

**Intersection 9 Monitor Drive-Bonanza Drive/SR-248 Signal**

Direction	Movement	Demand Volume (vph)	Served Volume (vph)		Total Delay (sec/veh)		
			Average	Percent	Average	Std. Dev.	LOS
NB	Left Turn	64	56	87.3%	20.2	6.0	C
	Through	28	30	105.4%	23.5	5.5	C
	Right Turn	117	114	97.3%	3.2	0.8	A
	Subtotal	209	199	95.3%	10.9	1.4	B
SB	Left Turn	54	54	99.1%	22.2	3.5	C
	Through	71	74	103.5%	22.2	4.1	C
	Right Turn	29	30	103.4%	4.7	1.4	A
	Subtotal	154	157	101.9%	19.1	2.6	B
EB	Left Turn	22	20	90.9%	8.4	3.9	A
	Through	230	234	101.9%	17.5	2.6	B
	Right Turn	95	97	102.0%	11.2	3.8	B
	Subtotal	347	351	101.2%	15.3	2.5	B
WB	Left Turn	304	299	98.4%	14.1	2.4	B
	Through	324	331	102.0%	8.3	1.0	A
	Right Turn	47	45	94.7%	3.9	1.9	A
	Subtotal	675	674	99.9%	10.7	1.3	B
Total		1,385	1,382	99.8%	12.9	1.4	B

**SimTraffic Post-Processor**  
**Average Results from 10 Runs**  
**Volume and Delay by Movement**

**Snow Park Village**  
**Existing Plus Project - Bus Option - Mitigated**  
**PM Peak Hour**

**Intersection 1**                      **Deer Valley Drive East/Doe Pass Road**                      **Signal**

Direction	Movement	Demand Volume (vph)	Served Volume (vph)		Total Delay (sec/veh)		LOS
			Average	Percent	Average	Std. Dev.	
NB	Left Turn	696	692	99.4%	5.5	2.1	A
	Through						
	Right Turn						
	Subtotal						
SB	Left Turn	238	239	100.4%	3.2	1.4	A
	Through						
	Right Turn						
	Subtotal						
EB	Left Turn	26	26	101.5%	14.4	6.7	B
	Through						
	Right Turn						
	Subtotal						
WB	Left Turn						
	Through						
	Right Turn						
	Subtotal						
<b>Total</b>		<b>975</b>	<b>970</b>	<b>99.5%</b>	<b>5.1</b>	<b>1.8</b>	<b>A</b>

**Intersection 2**                      **Deer Valley Drive West/Doe Pass Road**                      **Side-street Stop**

Direction	Movement	Demand Volume (vph)	Served Volume (vph)		Total Delay (sec/veh)		LOS
			Average	Percent	Average	Std. Dev.	
NB	Left Turn	20	20	100.0%	5.2	0.7	A
	Through						
	Right Turn						
	Subtotal						
SB	Left Turn						
	Through						
	Right Turn						
	Subtotal						
EB	Left Turn	114	118	103.3%	0.3	0.2	A
	Through						
	Right Turn						
	Subtotal						
WB	Left Turn	227	223	98.2%	2.0	0.1	A
	Through						
	Right Turn						
	Subtotal						
<b>Total</b>		<b>381</b>	<b>380</b>	<b>99.7%</b>	<b>1.5</b>	<b>0.1</b>	<b>A</b>

**SimTraffic Post-Processor**  
**Average Results from 10 Runs**  
**Volume and Delay by Movement**

**Snow Park Village**  
**Existing Plus Project - Bus Option - Mitigated**  
**PM Peak Hour**

**Intersection 3**                      **Deer Valley Drive East/Queen Esther Drive**                      **Side-street Stop**

Direction	Movement	Demand Volume (vph)	Served Volume (vph)		Total Delay (sec/veh)		
			Average	Percent	Average	Std. Dev.	LOS
NB	Left Turn						
	Through	726	729	100.5%	0.7	0.1	A
	Right Turn	30	31	103.7%	0.5	0.1	A
	Subtotal	756	760	100.6%	0.6	0.1	A
SB	Left Turn	85	92	108.5%	7.7	1.4	A
	Through	274	273	99.6%	0.4	0.1	A
	Right Turn						
	Subtotal	359	365	101.7%	2.4	0.5	A
EB	Left Turn						
	Through						
	Right Turn						
	Subtotal						
WB	Left Turn	29	26	89.3%	15.4	4.8	C
	Through						
	Right Turn	60	60	99.5%	11.1	6.5	B
	Subtotal	89	86	96.2%	12.9	5.3	B
<b>Total</b>		<b>1,204</b>	<b>1,211</b>	<b>100.6%</b>	<b>2.0</b>	<b>0.7</b>	<b>A</b>

**Intersection 4**                      **Solamere Drive/Deer Valley Drive East**                      **Side-street Stop**

Direction	Movement	Demand Volume (vph)	Served Volume (vph)		Total Delay (sec/veh)		
			Average	Percent	Average	Std. Dev.	LOS
NB	Left Turn						
	Through						
	Right Turn						
	Subtotal						
SB	Left Turn	17	15	87.6%	20.4	17.6	C
	Through						
	Right Turn	80	83	103.4%	15.4	5.5	C
	Subtotal	97	98	100.6%	16.4	6.2	C
EB	Left Turn	87	82	93.7%	10.4	2.8	B
	Through	342	346	101.3%	2.0	0.3	A
	Right Turn						
	Subtotal	429	428	99.7%	3.6	0.7	A
WB	Left Turn						
	Through	752	751	99.8%	1.0	0.1	A
	Right Turn	34	37	109.1%	0.6	0.1	A
	Subtotal	786	788	100.2%	1.0	0.1	A
<b>Total</b>		<b>1,312</b>	<b>1,313</b>	<b>100.1%</b>	<b>2.9</b>	<b>0.8</b>	<b>A</b>

**SimTraffic Post-Processor**  
**Average Results from 10 Runs**  
**Volume and Delay by Movement**

**Snow Park Village**  
**Existing Plus Project - Bus Option - Mitigated**  
**PM Peak Hour**

**Intersection 5**                      **Deer Valley Drive West/Deer Valley Drive East**                      **Signal**

Direction	Movement	Demand Volume (vph)	Served Volume (vph)		Total Delay (sec/veh)		
			Average	Percent	Average	Std. Dev.	LOS
NB	Left Turn						
	Through	203	198	97.4%	36.8	6.7	D
	Right Turn	44	47	106.1%	27.7	11.2	C
	Subtotal	247	245	99.0%	34.8	7.0	C
SB	Left Turn	385	380	98.6%	9.3	3.1	A
	Through	112	115	102.7%	3.2	1.2	A
	Right Turn						
	Subtotal	497	495	99.5%	7.8	2.6	A
EB	Left Turn						
	Through						
	Right Turn						
	Subtotal						
WB	Left Turn	22	21	97.3%	49.7	15.9	D
	Through						
	Right Turn	810	805	99.4%	16.0	5.7	B
	Subtotal	832	827	99.3%	16.9	6.0	B
<b>Total</b>		<b>1,576</b>	<b>1,566</b>	<b>99.3%</b>	<b>16.8</b>	<b>4.4</b>	<b>B</b>

**Intersection 7**                      **Deer Valley Drive/Bonanza Drive**                      **Signal**

Direction	Movement	Demand Volume (vph)	Served Volume (vph)		Total Delay (sec/veh)		
			Average	Percent	Average	Std. Dev.	LOS
NB	Left Turn						
	Through	804	791	98.4%	34.5	8.1	C
	Right Turn	671	671	100.0%	23.4	8.4	C
	Subtotal	1,475	1,463	99.2%	29.4	8.2	C
SB	Left Turn	251	198	79.0%	20.8	3.0	C
	Through	512	436	85.1%	8.1	1.1	A
	Right Turn						
	Subtotal	763	634	83.1%	12.0	1.5	B
EB	Left Turn						
	Through						
	Right Turn						
	Subtotal						
WB	Left Turn	440	445	101.2%	24.7	2.8	C
	Through						
	Right Turn	129	127	98.3%	10.8	3.1	B
	Subtotal	569	572	100.5%	21.7	2.8	C
<b>Total</b>		<b>2,807</b>	<b>2,669</b>	<b>95.1%</b>	<b>23.6</b>	<b>5.4</b>	<b>C</b>

SimTraffic Post-Processor  
Average Results from 10 Runs  
Volume and Delay by Movement

Snow Park Village  
Existing Plus Project - Bus Option - Mitigated  
PM Peak Hour

Intersection 8 SR-224-Park Avenue/Empire Avenue-Deer Valley Drive Signal

Direction	Movement	Demand Volume (vph)	Served Volume (vph)		Total Delay (sec/veh)		
			Average	Percent	Average	Std. Dev.	LOS
NB	Left Turn	35	35	100.6%	33.6	8.7	C
	Through	395	400	101.2%	50.3	3.2	D
	Right Turn	68	66	97.5%	31.6	11.3	C
	Subtotal	498	501	100.6%	46.7	3.8	D
SB	Left Turn	547	388	70.9%	225.4	13.0	F
	Through	363	263	72.3%	177.2	11.9	F
	Right Turn	364	265	72.9%	48.7	7.0	D
	Subtotal	1,274	916	71.9%	161.9	8.6	F
EB	Left Turn	633	536	84.7%	84.6	5.2	F
	Through	277	233	84.2%	64.2	12.6	E
	Right Turn	36	29	79.2%	51.0	12.6	D
	Subtotal	946	798	84.3%	77.5	5.9	E
WB	Left Turn	75	68	90.5%	72.5	7.9	E
	Through	239	287	120.0%	45.1	7.8	D
	Right Turn	690	643	93.2%	49.1	5.0	D
	Subtotal	1,004	998	99.4%	49.5	3.8	D
Total		3,722	3,212	86.3%	86.7	2.3	F

Intersection 9 Monitor Drive-Bonanza Drive/SR-248 Signal

Direction	Movement	Demand Volume (vph)	Served Volume (vph)		Total Delay (sec/veh)		
			Average	Percent	Average	Std. Dev.	LOS
NB	Left Turn	176	166	94.2%	37.8	12.8	D
	Through	89	95	107.2%	33.2	8.0	C
	Right Turn	499	470	94.1%	11.6	3.3	B
	Subtotal	764	731	95.6%	20.4	5.6	C
SB	Left Turn	90	86	95.2%	28.3	7.1	C
	Through	55	55	100.5%	38.5	8.9	D
	Right Turn	63	62	98.7%	4.5	0.4	A
	Subtotal	208	203	97.7%	24.2	4.2	C
EB	Left Turn	71	65	91.0%	13.6	3.1	B
	Through	584	599	102.6%	26.5	2.7	C
	Right Turn	149	149	100.2%	20.3	1.5	C
	Subtotal	804	813	101.1%	24.3	2.2	C
WB	Left Turn	239	237	99.2%	19.2	2.8	B
	Through	384	394	102.6%	9.9	1.3	A
	Right Turn	46	48	103.5%	7.7	3.0	A
	Subtotal	669	679	101.4%	13.1	1.6	B
Total		2,445	2,426	99.2%	19.9	2.1	B



**SimTraffic Post-Processor**  
**Average Results from 10 Runs**  
**Volume and Delay by Movement**

**Snow Park Village**  
**Opening Year Background**  
**AM Peak Hour**

**Intersection 3**                      **Deer Valley Drive East/Queen Esther Drive**                      **Side-street Stop**

Direction	Movement	Demand Volume (vph)	Served Volume (vph)		Total Delay (sec/veh)		
			Average	Percent	Average	Std. Dev.	LOS
NB	Left Turn						
	Through	75	75	99.6%	0.2	0.2	A
	Right Turn	20	18	90.0%	0.5	1.0	A
	Subtotal	95	93	97.6%	0.2	0.3	A
SB	Left Turn	50	50	99.8%	4.0	0.4	A
	Through	120	126	105.3%	1.0	0.2	A
	Right Turn						
	Subtotal	170	176	103.7%	1.9	0.3	A
EB	Left Turn						
	Through						
	Right Turn						
	Subtotal						
WB	Left Turn	20	22	111.0%	5.9	1.1	A
	Through						
	Right Turn	55	55	100.2%	5.1	0.3	A
	Subtotal	75	77	103.1%	5.3	0.5	A
<b>Total</b>		<b>340</b>	<b>346</b>	<b>101.9%</b>	<b>2.2</b>	<b>0.2</b>	<b>A</b>

**Intersection 4**                      **Solamere Drive/Deer Valley Drive East**                      **Side-street Stop**

Direction	Movement	Demand Volume (vph)	Served Volume (vph)		Total Delay (sec/veh)		
			Average	Percent	Average	Std. Dev.	LOS
NB	Left Turn						
	Through						
	Right Turn						
	Subtotal						
SB	Left Turn	25	24	94.8%	6.2	1.6	A
	Through						
	Right Turn	60	62	104.0%	5.8	0.8	A
	Subtotal	85	86	101.3%	5.9	0.9	A
EB	Left Turn	50	51	101.0%	4.3	0.6	A
	Through	145	153	105.4%	1.5	0.5	A
	Right Turn						
	Subtotal	195	203	104.3%	2.3	0.5	A
WB	Left Turn						
	Through	110	109	99.2%	1.0	0.3	A
	Right Turn	20	21	104.0%	0.8	0.6	A
	Subtotal	130	130	99.9%	1.0	0.2	A
<b>Total</b>		<b>410</b>	<b>419</b>	<b>102.3%</b>	<b>2.6</b>	<b>0.4</b>	<b>A</b>

**SimTraffic Post-Processor**  
**Average Results from 10 Runs**  
**Volume and Delay by Movement**

**Snow Park Village**  
**Opening Year Background**  
**AM Peak Hour**

**Intersection 5**                      **Deer Valley Drive West/Deer Valley Drive East**                      **Side-street Stop**

Direction	Movement	Demand Volume (vph)	Served Volume (vph)		Total Delay (sec/veh)		
			Average	Percent	Average	Std. Dev.	LOS
NB	Left Turn						
	Through	150	151	100.9%	1.2	0.3	A
	Right Turn	15	15	101.3%	0.7	0.8	A
	Subtotal	165	167	100.9%	1.2	0.3	A
SB	Left Turn	180	186	103.6%	5.7	0.5	A
	Through	635	636	100.2%	3.6	0.4	A
	Right Turn						
	Subtotal	815	823	100.9%	4.1	0.2	A
EB	Left Turn						
	Through						
	Right Turn						
	Subtotal						
WB	Left Turn	10	9	90.0%	14.2	10.1	B
	Through						
	Right Turn	160	162	101.2%	4.5	0.6	A
	Subtotal	170	171	100.5%	5.0	1.0	A
<b>Total</b>		<b>1,150</b>	<b>1,160</b>	<b>100.9%</b>	<b>3.8</b>	<b>0.2</b>	<b>A</b>

**Intersection 7**                      **Deer Valley Drive/Bonanza Drive**                      **Signal**

Direction	Movement	Demand Volume (vph)	Served Volume (vph)		Total Delay (sec/veh)		
			Average	Percent	Average	Std. Dev.	LOS
NB	Left Turn						
	Through	265	263	99.3%	12.8	2.3	B
	Right Turn	165	170	102.7%	2.7	0.9	A
	Subtotal	430	433	100.6%	9.1	1.6	A
SB	Left Turn	115	102	89.0%	11.7	2.9	B
	Through	635	620	97.6%	9.7	1.8	A
	Right Turn						
	Subtotal	750	722	96.3%	10.0	1.9	B
EB	Left Turn						
	Through						
	Right Turn						
	Subtotal						
WB	Left Turn	585	591	101.0%	15.6	0.8	B
	Through						
	Right Turn	215	222	103.4%	5.4	1.3	A
	Subtotal	800	813	101.6%	12.8	0.9	B
<b>Total</b>		<b>1,980</b>	<b>1,968</b>	<b>99.4%</b>	<b>11.0</b>	<b>1.1</b>	<b>B</b>

**SimTraffic Post-Processor**  
**Average Results from 10 Runs**  
**Volume and Delay by Movement**

**Snow Park Village**  
**Opening Year Background**  
**AM Peak Hour**

**Intersection 8 SR-224-Park Avenue/Empire Avenue-Deer Valley Drive Signal**

Direction	Movement	Demand Volume (vph)	Served Volume (vph)		Total Delay (sec/veh)		
			Average	Percent	Average	Std. Dev.	LOS
NB	Left Turn	55	51	93.5%	34.8	3.8	C
	Through	195	198	101.3%	51.8	5.3	D
	Right Turn	75	73	96.9%	19.4	5.8	B
	Subtotal	325	322	99.0%	41.9	4.6	D
SB	Left Turn	475	404	85.1%	212.0	13.3	F
	Through	170	146	85.7%	173.4	18.6	F
	Right Turn	1,065	917	86.1%	72.5	16.1	E
	Subtotal	1,710	1,467	85.8%	121.5	7.1	F
EB	Left Turn	385	392	101.7%	44.4	7.5	D
	Through	240	238	99.0%	28.5	5.7	C
	Right Turn	25	28	111.6%	28.3	14.5	C
	Subtotal	650	657	101.1%	38.2	7.0	D
WB	Left Turn	50	48	96.2%	75.9	14.9	E
	Through	325	355	109.3%	68.7	15.7	E
	Right Turn	215	218	101.2%	10.0	1.9	B
	Subtotal	590	621	105.2%	49.4	9.8	D
Total		3,275	3,067	93.6%	81.9	6.0	F

**Intersection 9 Monitor Drive-Bonanza Drive/SR-248 Signal**

Direction	Movement	Demand Volume (vph)	Served Volume (vph)		Total Delay (sec/veh)		
			Average	Percent	Average	Std. Dev.	LOS
NB	Left Turn	65	58	89.4%	22.8	5.7	C
	Through	30	30	99.0%	23.4	6.9	C
	Right Turn	110	106	96.5%	3.1	0.7	A
	Subtotal	205	194	94.6%	12.2	2.4	B
SB	Left Turn	60	56	93.2%	18.4	7.3	B
	Through	75	75	99.9%	25.4	4.2	C
	Right Turn	30	31	103.0%	4.8	1.0	A
	Subtotal	165	162	98.0%	18.9	3.0	B
EB	Left Turn	25	24	95.6%	14.8	1.9	B
	Through	250	247	98.9%	18.6	2.4	B
	Right Turn	100	99	98.6%	8.5	2.4	A
	Subtotal	375	370	98.6%	15.8	2.2	B
WB	Left Turn	305	309	101.3%	14.0	2.3	B
	Through	350	344	98.4%	8.6	1.3	A
	Right Turn	50	49	98.8%	4.8	2.0	A
	Subtotal	705	703	99.7%	10.7	1.3	B
Total		1,450	1,428	98.5%	13.1	1.2	B

# MOVEMENT SUMMARY

 Site: 101 [2024 BG AM]

Deer Valley Drive / Marsac Avenue Roundabout  
 Site Category: (None)  
 Roundabout

Movement Performance - Vehicles												
Mov ID	Turn	Demand Total	Flows HV %	Deg. Satn v/c	Average Delay sec	Level of Service	95% Back of Queue Vehicles veh	of Queue Distance ft	Prop. Queued	Effective Stop Rate	Aver. No. Cycles	Average Speed mph
South: Marsac Avenue												
3	L2	5	100.0	0.174	14.0	LOS B	0.6	15.9	0.63	0.63	0.63	33.7
8	T1	133	3.0	0.174	8.2	LOS A	0.6	16.1	0.63	0.63	0.63	33.9
18b	R3	64	3.0	0.174	8.2	LOS A	0.6	16.1	0.64	0.64	0.64	32.4
Approach		202	5.6	0.174	8.4	LOS A	0.6	16.1	0.63	0.63	0.63	33.4
SouthEast: RoadName												
3bx	L3	32	3.0	0.150	4.5	LOS A	0.5	15.5	0.32	0.19	0.32	35.8
3ax	L1	21	100.0	0.150	7.4	LOS A	0.5	15.5	0.32	0.19	0.32	34.4
18ax	R1	277	3.0	0.150	4.4	LOS A	0.6	16.1	0.32	0.20	0.32	35.5
Approach		330	9.3	0.150	4.6	LOS A	0.6	16.1	0.32	0.20	0.32	35.4
North: Deer Valley Drive												
7u	U	27	3.0	0.769	15.4	LOS C	9.2	236.0	0.59	0.32	0.59	30.0
7a	L1	809	3.0	0.769	15.4	LOS C	9.2	236.0	0.59	0.32	0.59	29.1
4	T1	383	3.0	0.769	8.7	LOS A	9.2	236.0	0.36	0.19	0.36	33.1
14	R2	16	100.0	0.210	7.3	LOS A	0.9	24.1	0.22	0.11	0.22	34.4
Approach		1234	4.3	0.769	13.2	LOS B	9.2	236.0	0.51	0.27	0.51	30.3
West: Transit Center												
5	L2	5	100.0	0.201	19.9	LOS C	0.3	14.9	0.69	0.69	0.69	28.9
12a	R1	27	100.0	0.201	19.9	LOS C	0.3	14.9	0.69	0.69	0.69	28.6
12	R2	16	100.0	0.201	19.9	LOS C	0.3	14.9	0.69	0.69	0.69	28.0
Approach		48	100.0	0.201	19.9	LOS C	0.3	14.9	0.69	0.69	0.69	28.4
All Vehicles		1814	7.8	0.769	11.3	LOS B	9.2	236.0	0.50	0.31	0.50	31.4

Site Level of Service (LOS) Method: Delay & v/c (HCM 6). Site LOS Method is specified in the Parameter Settings dialog (Site tab).

Roundabout LOS Method: Same as Sign Control.

Vehicle movement LOS values are based on average delay and v/c ratio (degree of saturation) per movement.

LOS F will result if v/c > 1 irrespective of movement delay value (does not apply for approaches and intersection).

Intersection and Approach LOS values are based on average delay for all movements (v/c not used as specified in HCM 6).

Roundabout Capacity Model: US HCM 6.

HCM Delay Formula option is used. Control Delay does not include Geometric Delay since Exclude Geometric Delay option applies.

Gap-Acceptance Capacity: Traditional M1.

HV (%) values are calculated for All Movement Classes of All Heavy Vehicle Model Designation.

**SimTraffic Post-Processor**  
**Average Results from 10 Runs**  
**Volume and Delay by Movement**

**Snow Park Village**  
**Opening Year Background**  
**PM Peak Hour**

**Intersection 3**                      **Deer Valley Drive East/Queen Esther Drive**                      **Side-street Stop**

Direction	Movement	Demand Volume (vph)	Served Volume (vph)		Total Delay (sec/veh)		
			Average	Percent	Average	Std. Dev.	LOS
NB	Left Turn						
	Through	305	317	103.8%	1.0	0.2	A
	Right Turn	30	32	108.0%	0.9	0.7	A
	Subtotal	335	349	104.1%	1.0	0.2	A
SB	Left Turn	85	86	100.8%	5.1	0.7	A
	Through	85	84	99.3%	1.8	0.9	A
	Right Turn						
	Subtotal	170	170	100.1%	3.3	0.7	A
EB	Left Turn						
	Through						
	Right Turn						
	Subtotal						
WB	Left Turn	30	25	83.7%	8.2	2.8	A
	Through						
	Right Turn	60	61	102.3%	5.8	0.5	A
	Subtotal	90	87	96.1%	6.5	0.9	A
<b>Total</b>		<b>595</b>	<b>606</b>	<b>101.8%</b>	<b>2.4</b>	<b>0.3</b>	<b>A</b>

**Intersection 4**                      **Solamere Drive/Deer Valley Drive East**                      **Side-street Stop**

Direction	Movement	Demand Volume (vph)	Served Volume (vph)		Total Delay (sec/veh)		
			Average	Percent	Average	Std. Dev.	LOS
NB	Left Turn						
	Through						
	Right Turn						
	Subtotal						
SB	Left Turn	20	19	93.0%	11.2	4.5	B
	Through						
	Right Turn	80	80	99.9%	6.5	0.7	A
	Subtotal	100	99	98.5%	7.3	1.1	A
EB	Left Turn	90	89	99.1%	5.8	1.1	A
	Through	150	149	99.3%	1.8	0.6	A
	Right Turn						
	Subtotal	240	238	99.3%	3.3	0.8	A
WB	Left Turn						
	Through	330	339	102.6%	1.1	0.1	A
	Right Turn	35	38	108.6%	1.4	0.5	A
	Subtotal	365	377	103.2%	1.1	0.1	A
<b>Total</b>		<b>705</b>	<b>713</b>	<b>101.2%</b>	<b>2.7</b>	<b>0.3</b>	<b>A</b>

SimTraffic Post-Processor  
Average Results from 10 Runs  
Volume and Delay by Movement

Snow Park Village  
Opening Year Background  
PM Peak Hour

Intersection 5                      Deer Valley Drive West/Deer Valley Drive East                      Side-street Stop

Direction	Movement	Demand Volume (vph)	Served Volume (vph)		Total Delay (sec/veh)		
			Average	Percent	Average	Std. Dev.	LOS
NB	Left Turn						
	Through	545	547	100.3%	3.6	0.4	A
	Right Turn	45	45	100.9%	1.8	0.7	A
	Subtotal	590	592	100.3%	3.5	0.3	A
SB	Left Turn	195	191	98.1%	8.7	2.1	A
	Through	210	209	99.6%	1.7	0.4	A
	Right Turn						
	Subtotal	405	401	98.9%	5.1	1.3	A
EB	Left Turn						
	Through						
	Right Turn						
	Subtotal						
WB	Left Turn	25	27	108.0%	41.3	27.9	E
	Through						
	Right Turn	385	390	101.3%	36.6	16.7	E
	Subtotal	410	417	101.7%	36.7	16.9	E
Total		1,405	1,410	100.3%	13.6	5.5	B

Intersection 7                      Deer Valley Drive/Bonanza Drive                      Signal

Direction	Movement	Demand Volume (vph)	Served Volume (vph)		Total Delay (sec/veh)		
			Average	Percent	Average	Std. Dev.	LOS
NB	Left Turn						
	Through	755	743	98.4%	27.5	2.6	C
	Right Turn	690	696	100.9%	17.7	1.5	B
	Subtotal	1,445	1,440	99.6%	22.9	1.9	C
SB	Left Turn	275	204	74.3%	20.6	3.6	C
	Through	460	376	81.8%	7.6	1.8	A
	Right Turn						
	Subtotal	735	581	79.0%	12.2	1.6	B
EB	Left Turn						
	Through						
	Right Turn						
	Subtotal						
WB	Left Turn	445	444	99.7%	25.4	4.0	C
	Through						
	Right Turn	145	148	101.7%	10.0	2.0	A
	Subtotal	590	591	100.2%	21.6	3.2	C
Total		2,770	2,611	94.3%	20.1	1.3	C

SimTraffic Post-Processor  
Average Results from 10 Runs  
Volume and Delay by Movement

Snow Park Village  
Opening Year Background  
PM Peak Hour

Intersection 8 SR-224-Park Avenue/Empire Avenue-Deer Valley Drive Signal

Direction	Movement	Demand Volume (vph)	Served Volume (vph)		Total Delay (sec/veh)		
			Average	Percent	Average	Std. Dev.	LOS
NB	Left Turn	35	34	97.1%	33.2	6.1	C
	Through	395	399	101.0%	50.8	4.0	D
	Right Turn	70	77	110.6%	29.5	7.9	C
	Subtotal	500	510	102.0%	46.6	3.9	D
SB	Left Turn	495	370	74.7%	223.0	17.6	F
	Through	365	274	75.2%	174.9	13.5	F
	Right Turn	445	334	75.0%	47.8	7.2	D
	Subtotal	1,305	978	75.0%	151.2	13.7	F
EB	Left Turn	765	500	65.3%	84.9	4.7	F
	Through	355	231	65.1%	62.3	12.7	E
	Right Turn	50	37	73.6%	54.3	17.3	D
	Subtotal	1,170	768	65.6%	77.0	6.3	E
WB	Left Turn	80	76	94.8%	81.2	17.1	F
	Through	310	357	115.0%	63.5	15.9	E
	Right Turn	640	630	98.4%	37.7	7.7	D
	Subtotal	1,030	1,062	103.1%	49.3	9.0	D
Total		4,005	3,318	82.8%	84.7	2.6	F

Intersection 9 Monitor Drive-Bonanza Drive/SR-248 Signal

Direction	Movement	Demand Volume (vph)	Served Volume (vph)		Total Delay (sec/veh)		
			Average	Percent	Average	Std. Dev.	LOS
NB	Left Turn	180	175	97.0%	32.9	5.9	C
	Through	90	93	103.3%	31.5	5.6	C
	Right Turn	505	468	92.6%	12.2	2.4	B
	Subtotal	775	735	94.9%	19.7	2.1	B
SB	Left Turn	100	99	99.4%	34.1	6.9	C
	Through	55	58	105.6%	39.6	4.9	D
	Right Turn	65	66	101.5%	6.1	1.7	A
	Subtotal	220	224	101.6%	28.0	3.2	C
EB	Left Turn	75	76	101.2%	16.2	3.3	B
	Through	635	642	101.0%	25.9	2.6	C
	Right Turn	150	147	97.9%	20.9	3.6	C
	Subtotal	860	864	100.5%	24.3	2.2	C
WB	Left Turn	230	223	97.0%	19.6	3.8	B
	Through	420	430	102.4%	11.5	2.2	B
	Right Turn	50	51	102.8%	8.4	3.4	A
	Subtotal	700	705	100.7%	13.8	1.9	B
Total		2,555	2,528	98.9%	20.4	1.5	C



# MOVEMENT SUMMARY

 Site: 101 [2024 BG PM]

Deer Valley Drive / Marsac Avenue Roundabout  
 Site Category: (None)  
 Roundabout

Movement Performance - Vehicles												
Mov ID	Turn	Demand Total	Flows HV %	Deg. Satn v/c	Average Delay sec	Level of Service	95% Back Vehicles veh	of Queue Distance ft	Prop. Queued	Effective Stop Rate	Aver. No. Cycles	Average Speed mph
South: Marsac Avenue												
3	L2	1	100.0	0.356	13.9	LOS B	1.6	41.4	0.65	0.67	0.73	32.8
8	T1	460	3.0	0.356	9.3	LOS A	1.6	41.5	0.65	0.67	0.73	33.6
18b	R3	66	3.0	0.356	9.3	LOS A	1.6	41.5	0.65	0.67	0.73	32.0
Approach		526	3.2	0.356	9.3	LOS A	1.6	41.5	0.65	0.67	0.73	33.4
SouthEast: RoadName												
3bx	L3	40	3.0	0.582	15.1	LOS C	4.0	106.0	0.75	0.94	1.29	31.4
3ax	L1	15	100.0	0.582	19.9	LOS C	4.0	106.0	0.75	0.94	1.29	30.0
18ax	R1	753	3.0	0.582	15.0	LOS B	4.2	107.0	0.76	0.94	1.29	30.7
Approach		808	4.8	0.582	15.1	LOS C	4.2	107.0	0.76	0.94	1.29	30.7
North: Deer Valley Drive												
7u	U	242	3.0	0.636	10.7	LOS B	5.6	143.3	0.40	0.20	0.40	31.7
7a	L1	379	3.0	0.636	10.7	LOS B	5.6	143.3	0.40	0.20	0.40	30.8
4	T1	404	3.0	0.636	7.5	LOS A	5.6	143.3	0.30	0.14	0.30	33.4
14	R2	10	100.0	0.174	6.9	LOS A	0.7	19.3	0.20	0.09	0.20	34.6
Approach		1035	3.9	0.636	9.4	LOS A	5.6	143.3	0.35	0.17	0.35	32.0
West: Transit Center												
5	L2	5	100.0	0.090	14.6	LOS B	0.1	6.7	0.62	0.62	0.62	30.9
12a	R1	15	100.0	0.090	14.6	LOS B	0.1	6.7	0.62	0.62	0.62	30.4
12	R2	5	100.0	0.090	14.6	LOS B	0.1	6.7	0.62	0.62	0.62	29.8
Approach		25	100.0	0.090	14.6	LOS B	0.1	6.7	0.62	0.62	0.62	30.4
All Vehicles		2395	5.1	0.636	11.4	LOS B	5.6	143.3	0.56	0.55	0.75	31.8

Site Level of Service (LOS) Method: Delay & v/c (HCM 6). Site LOS Method is specified in the Parameter Settings dialog (Site tab).

Roundabout LOS Method: Same as Sign Control.

Vehicle movement LOS values are based on average delay and v/c ratio (degree of saturation) per movement.

LOS F will result if v/c > 1 irrespective of movement delay value (does not apply for approaches and intersection).

Intersection and Approach LOS values are based on average delay for all movements (v/c not used as specified in HCM 6).

Roundabout Capacity Model: US HCM 6.

HCM Delay Formula option is used. Control Delay does not include Geometric Delay since Exclude Geometric Delay option applies.

Gap-Acceptance Capacity: Traditional M1.

HV (%) values are calculated for All Movement Classes of All Heavy Vehicle Model Designation.

SimTraffic Post-Processor  
Average Results from 10 Runs  
Volume and Delay by Movement

Snow Park Village  
Opening Year Plus Project  
AM Peak Hour

**Intersection 1**                      **Deer Valley Drive East/Doe Pass Road**                      **Signal**

Direction	Movement	Demand Volume (vph)	Served Volume (vph)		Total Delay (sec/veh)		LOS
			Average	Percent	Average	Std. Dev.	
NB	Left Turn	98	100	101.6%	1.0	0.9	A
	Through						
	Right Turn						
	Subtotal						
SB	Left Turn	168	168	100.1%	1.4	0.5	A
	Through						
	Right Turn						
	Subtotal						
EB	Left Turn	31	29	92.9%	7.3	0.8	A
	Through						
	Right Turn						
	Subtotal						
WB	Left Turn						
	Through						
	Right Turn						
	Subtotal						
Total		312	310	99.3%	1.8	0.7	A

**Intersection 2**                      **Deer Valley Drive West/Doe Pass Road**                      **Side-street Stop**

Direction	Movement	Demand Volume (vph)	Served Volume (vph)		Total Delay (sec/veh)		LOS
			Average	Percent	Average	Std. Dev.	
NB	Left Turn	20	20	99.5%	10.0	4.2	B
	Through						
	Right Turn						
	Subtotal						
SB	Left Turn						
	Through						
	Right Turn						
	Subtotal						
EB	Left Turn	651	653	100.4%	3.2	0.3	A
	Through						
	Right Turn						
	Subtotal						
WB	Left Turn	145	146	100.8%	1.8	0.5	A
	Through						
	Right Turn						
	Subtotal						
Total		836	840	100.5%	3.2	0.2	A

SimTraffic Post-Processor  
Average Results from 10 Runs  
Volume and Delay by Movement

Snow Park Village  
Opening Year Plus Project  
AM Peak Hour

**Intersection 3**                      **Deer Valley Drive East/Queen Esther Drive**                      **Side-street Stop**

Direction	Movement	Demand Volume (vph)	Served Volume (vph)		Total Delay (sec/veh)		
			Average	Percent	Average	Std. Dev.	LOS
NB	Left Turn						
	Through	154	155	100.6%	0.4	0.2	A
	Right Turn	20	20	99.0%	0.5	0.7	A
	Subtotal	174	175	100.4%	0.4	0.2	A
SB	Left Turn	50	51	101.6%	4.2	0.5	A
	Through	177	176	99.5%	1.2	0.3	A
	Right Turn						
	Subtotal	227	227	100.0%	1.9	0.3	A
EB	Left Turn						
	Through						
	Right Turn						
	Subtotal						
WB	Left Turn	20	21	104.0%	7.1	3.5	A
	Through						
	Right Turn	55	55	99.5%	5.7	0.9	A
	Subtotal	75	76	100.7%	6.3	1.0	A
Total		476	477	100.2%	2.0	0.4	A

**Intersection 4**                      **Solamere Drive/Deer Valley Drive East**                      **Side-street Stop**

Direction	Movement	Demand Volume (vph)	Served Volume (vph)		Total Delay (sec/veh)		
			Average	Percent	Average	Std. Dev.	LOS
NB	Left Turn						
	Through						
	Right Turn						
	Subtotal						
SB	Left Turn	25	27	106.0%	7.9	2.1	A
	Through						
	Right Turn	60	62	103.0%	5.4	0.3	A
	Subtotal	85	88	103.9%	6.2	0.8	A
EB	Left Turn	50	49	98.8%	4.2	1.1	A
	Through	202	199	98.4%	1.5	0.4	A
	Right Turn						
	Subtotal	252	248	98.5%	2.0	0.6	A
WB	Left Turn						
	Through	189	186	98.4%	0.9	0.1	A
	Right Turn	20	21	104.0%	0.8	0.6	A
	Subtotal	209	207	98.9%	0.9	0.1	A
Total		546	543	99.5%	2.3	0.4	A

SimTraffic Post-Processor  
Average Results from 10 Runs  
Volume and Delay by Movement

Snow Park Village  
Opening Year Plus Project  
AM Peak Hour

**Intersection 5**                      **Deer Valley Drive West/Deer Valley Drive East**                      **Side-street Stop**

Direction	Movement	Demand Volume (vph)	Served Volume (vph)		Total Delay (sec/veh)		
			Average	Percent	Average	Std. Dev.	LOS
NB	Left Turn						
	Through	150	152	101.1%	1.2	0.4	A
	Right Turn	15	15	98.7%	0.6	0.7	A
	Subtotal	165	167	100.9%	1.1	0.3	A
SB	Left Turn	237	233	98.1%	6.0	0.7	A
	Through	661	661	100.1%	3.7	0.2	A
	Right Turn						
	Subtotal	898	894	99.5%	4.3	0.3	A
EB	Left Turn						
	Through						
	Right Turn						
	Subtotal						
WB	Left Turn	10	10	98.0%	13.4	11.0	B
	Through						
	Right Turn	239	236	98.6%	5.1	0.4	A
	Subtotal	249	245	98.6%	5.6	0.7	A
<b>Total</b>		<b>1,312</b>	<b>1,306</b>	<b>99.5%</b>	<b>4.1</b>	<b>0.3</b>	<b>A</b>

**Intersection 7**                      **Deer Valley Drive/Bonanza Drive**                      **Signal**

Direction	Movement	Demand Volume (vph)	Served Volume (vph)		Total Delay (sec/veh)		
			Average	Percent	Average	Std. Dev.	LOS
NB	Left Turn						
	Through	304	305	100.4%	14.0	1.8	B
	Right Turn	181	176	97.2%	3.2	0.7	A
	Subtotal	485	481	99.2%	10.2	1.3	B
SB	Left Turn	115	100	86.9%	13.5	3.6	B
	Through	677	641	94.7%	9.4	1.8	A
	Right Turn						
	Subtotal	792	741	93.5%	9.9	1.8	A
EB	Left Turn						
	Through						
	Right Turn						
	Subtotal						
WB	Left Turn	602	604	100.4%	17.1	2.9	B
	Through						
	Right Turn	215	212	98.4%	6.2	1.5	A
	Subtotal	817	816	99.9%	14.2	2.7	B
<b>Total</b>		<b>2,094</b>	<b>2,038</b>	<b>97.3%</b>	<b>11.7</b>	<b>1.7</b>	<b>B</b>

SimTraffic Post-Processor  
Average Results from 10 Runs  
Volume and Delay by Movement

Snow Park Village  
Opening Year Plus Project  
AM Peak Hour

**Intersection 8**                      **SR-224-Park Avenue/Empire Avenue-Deer Valley Drive**                      **Signal**

Direction	Movement	Demand Volume (vph)	Served Volume (vph)		Total Delay (sec/veh)		LOS
			Average	Percent	Average	Std. Dev.	
NB	Left Turn	55	58	104.5%	29.4	9.7	C
	Through	195	199	102.0%	51.1	5.7	D
	Right Turn	75	75	99.7%	18.5	5.4	B
	Subtotal	325	331	101.9%	39.7	5.7	D
SB	Left Turn	517	414	80.0%	214.0	13.8	F
	Through	170	135	79.6%	182.7	10.5	F
	Right Turn	1,065	859	80.6%	64.2	14.8	E
	Subtotal	1,752	1,408	80.4%	121.5	10.6	F
EB	Left Turn	385	369	95.9%	42.2	8.6	D
	Through	240	230	95.8%	27.8	12.6	C
	Right Turn	25	25	101.2%	23.3	30.1	C
	Subtotal	650	624	96.0%	36.1	9.9	D
WB	Left Turn	50	45	90.4%	82.7	18.0	F
	Through	325	354	108.9%	59.7	15.8	E
	Right Turn	254	252	99.0%	11.5	1.6	B
	Subtotal	629	651	103.4%	42.3	10.3	D
<b>Total</b>		<b>3,356</b>	<b>3,014</b>	<b>89.8%</b>	<b>78.5</b>	<b>5.3</b>	<b>E</b>

**Intersection 9**                      **Monitor Drive-Bonanza Drive/SR-248**                      **Signal**

Direction	Movement	Demand Volume (vph)	Served Volume (vph)		Total Delay (sec/veh)		LOS
			Average	Percent	Average	Std. Dev.	
NB	Left Turn	65	55	84.3%	22.5	4.9	C
	Through	30	27	91.3%	30.1	7.4	C
	Right Turn	126	124	98.7%	3.1	0.6	A
	Subtotal	221	207	93.4%	11.5	3.2	B
SB	Left Turn	60	58	96.3%	19.3	3.5	B
	Through	75	71	94.7%	24.7	4.7	C
	Right Turn	30	32	107.3%	5.1	0.8	A
	Subtotal	165	161	97.6%	18.8	3.2	B
EB	Left Turn	25	25	101.6%	10.1	2.9	B
	Through	250	248	99.0%	17.8	3.2	B
	Right Turn	100	99	99.1%	9.3	3.4	A
	Subtotal	375	372	99.2%	15.2	3.0	B
WB	Left Turn	322	320	99.4%	13.8	1.2	B
	Through	350	339	96.7%	8.2	1.6	A
	Right Turn	50	53	106.4%	4.6	1.4	A
	Subtotal	722	712	98.6%	10.5	1.0	B
<b>Total</b>		<b>1,483</b>	<b>1,451</b>	<b>97.9%</b>	<b>12.7</b>	<b>1.4</b>	<b>B</b>

# MOVEMENT SUMMARY

 Site: 101 [2024 Plus Project AM]

Deer Valley Drive / Marsac Avenue Roundabout  
 Site Category: (None)  
 Roundabout

Movement Performance - Vehicles												
Mov ID	Turn	Demand Total	Flows HV %	Deg. Satn v/c	Average Delay sec	Level of Service	95% Back of Queue Vehicles veh	of Queue Distance ft	Prop. Queued	Effective Stop Rate	Aver. No. Cycles	Average Speed mph
South: Marsac Avenue												
3	L2	5	100.0	0.196	15.4	LOS C	0.7	17.8	0.65	0.65	0.65	33.2
8	T1	133	3.0	0.196	9.2	LOS A	0.7	18.0	0.65	0.65	0.65	33.5
18b	R3	72	3.0	0.196	9.1	LOS A	0.7	18.0	0.66	0.66	0.66	31.9
Approach		211	5.4	0.196	9.3	LOS A	0.7	18.0	0.66	0.66	0.66	32.9
SouthEast: RoadName												
3bx	L3	40	3.0	0.188	4.8	LOS A	0.7	20.1	0.33	0.20	0.33	35.6
3ax	L1	26	100.0	0.188	7.7	LOS A	0.7	20.1	0.33	0.20	0.33	34.2
18ax	R1	348	3.0	0.188	4.8	LOS A	0.8	20.8	0.33	0.21	0.33	35.3
Approach		414	9.0	0.188	5.0	LOS A	0.8	20.8	0.33	0.21	0.33	35.2
North: Deer Valley Drive												
7u	U	27	3.0	0.829	19.0	LOS C	11.5	293.3	0.76	0.44	0.76	28.6
7a	L1	884	3.0	0.829	19.0	LOS C	11.5	293.3	0.76	0.44	0.76	27.8
4	T1	383	3.0	0.829	9.7	LOS A	11.5	293.3	0.42	0.23	0.42	32.8
14	R2	16	100.0	0.227	7.6	LOS A	1.0	26.3	0.25	0.13	0.25	34.3
Approach		1310	4.2	0.829	16.1	LOS C	11.5	293.3	0.65	0.38	0.65	29.2
West: Transit Center												
5	L2	5	100.0	0.236	22.5	LOS C	0.4	17.5	0.72	0.72	0.73	28.1
12a	R1	31	100.0	0.236	22.5	LOS C	0.4	17.5	0.72	0.72	0.73	27.7
12	R2	16	100.0	0.236	22.5	LOS C	0.4	17.5	0.72	0.72	0.73	27.2
Approach		52	100.0	0.236	22.5	LOS C	0.4	17.5	0.72	0.72	0.73	27.6
All Vehicles		1986	7.8	0.829	13.3	LOS B	11.5	293.3	0.59	0.38	0.59	30.6

Site Level of Service (LOS) Method: Delay & v/c (HCM 6). Site LOS Method is specified in the Parameter Settings dialog (Site tab).

Roundabout LOS Method: Same as Sign Control.

Vehicle movement LOS values are based on average delay and v/c ratio (degree of saturation) per movement.

LOS F will result if v/c > 1 irrespective of movement delay value (does not apply for approaches and intersection).

Intersection and Approach LOS values are based on average delay for all movements (v/c not used as specified in HCM 6).

Roundabout Capacity Model: US HCM 6.

HCM Delay Formula option is used. Control Delay does not include Geometric Delay since Exclude Geometric Delay option applies.

Gap-Acceptance Capacity: Traditional M1.

HV (%) values are calculated for All Movement Classes of All Heavy Vehicle Model Designation.

**SimTraffic Post-Processor**  
**Average Results from 10 Runs**  
**Volume and Delay by Movement**

**Snow Park Village**  
**Opening Year Plus Project**  
**PM Peak Hour**

**Intersection 1**                      **Deer Valley Drive East/Doe Pass Road**                      **Signal**

Direction	Movement	Demand Volume (vph)	Served Volume (vph)		Total Delay (sec/veh)		LOS
			Average	Percent	Average	Std. Dev.	
NB	Left Turn	375	369	98.4%	1.3	0.5	A
	Through						
	Right Turn						
	Subtotal	375	369	98.4%	1.3	0.5	A
SB	Left Turn	140	138	98.3%	1.1	0.7	A
	Through						
	Right Turn						
	Subtotal	155	153	98.6%	1.1	0.7	A
EB	Left Turn	26	24	91.9%	8.2	1.6	A
	Through						
	Right Turn						
	Subtotal	26	24	91.9%	8.2	1.6	A
WB	Left Turn						
	Through						
	Right Turn						
	Subtotal						
<b>Total</b>		<b>556</b>	<b>546</b>	<b>98.2%</b>	<b>1.6</b>	<b>0.5</b>	<b>A</b>

**Intersection 2**                      **Deer Valley Drive West/Doe Pass Road**                      **Side-street Stop**

Direction	Movement	Demand Volume (vph)	Served Volume (vph)		Total Delay (sec/veh)		LOS
			Average	Percent	Average	Std. Dev.	
NB	Left Turn	20	19	95.5%	14.5	5.7	B
	Through						
	Right Turn						
	Subtotal	20	19	95.5%	14.5	5.7	B
SB	Left Turn						
	Through						
	Right Turn						
	Subtotal						
EB	Left Turn	229	227	99.3%	1.6	0.4	A
	Through						
	Right Turn						
	Subtotal	249	246	98.8%	1.5	0.4	A
WB	Left Turn	570	568	99.6%	2.4	0.1	A
	Through						
	Right Turn						
	Subtotal	570	568	99.6%	2.4	0.1	A
<b>Total</b>		<b>839</b>	<b>833</b>	<b>99.2%</b>	<b>2.5</b>	<b>0.2</b>	<b>A</b>



SimTraffic Post-Processor  
Average Results from 10 Runs  
Volume and Delay by Movement

Snow Park Village  
Opening Year Plus Project  
PM Peak Hour

**Intersection 3**                      **Deer Valley Drive East/Queen Esther Drive**                      **Side-street Stop**

Direction	Movement	Demand Volume (vph)	Served Volume (vph)		Total Delay (sec/veh)		
			Average	Percent	Average	Std. Dev.	LOS
NB	Left Turn						
	Through	405	398	98.2%	1.2	0.2	A
	Right Turn	30	35	116.3%	1.1	0.7	A
	Subtotal	435	433	99.5%	1.2	0.2	A
SB	Left Turn	85	84	99.3%	5.4	0.5	A
	Through	175	180	102.6%	1.9	0.5	A
	Right Turn						
	Subtotal	260	264	101.5%	3.0	0.5	A
EB	Left Turn						
	Through						
	Right Turn						
	Subtotal						
WB	Left Turn	30	29	96.0%	10.0	3.5	A
	Through						
	Right Turn	60	59	99.0%	7.2	1.5	A
	Subtotal	90	88	98.0%	8.2	2.0	A
Total		785	785	100.0%	2.6	0.4	A

**Intersection 4**                      **Solamere Drive/Deer Valley Drive East**                      **Side-street Stop**

Direction	Movement	Demand Volume (vph)	Served Volume (vph)		Total Delay (sec/veh)		
			Average	Percent	Average	Std. Dev.	LOS
NB	Left Turn						
	Through						
	Right Turn						
	Subtotal						
SB	Left Turn	20	20	98.0%	11.8	4.9	B
	Through						
	Right Turn	80	82	102.6%	8.2	1.7	A
	Subtotal	100	102	101.7%	8.9	1.6	A
EB	Left Turn	90	90	99.9%	6.7	1.6	A
	Through	240	242	100.7%	2.7	0.6	A
	Right Turn						
	Subtotal	330	332	100.5%	3.7	0.8	A
WB	Left Turn						
	Through	430	421	97.9%	1.2	0.2	A
	Right Turn	35	34	96.6%	1.0	0.3	A
	Subtotal	465	455	97.8%	1.2	0.2	A
Total		895	888	99.2%	3.0	0.6	A

SimTraffic Post-Processor  
Average Results from 10 Runs  
Volume and Delay by Movement

Snow Park Village  
Opening Year Plus Project  
PM Peak Hour

**Intersection 5**                      **Deer Valley Drive West/Deer Valley Drive East**                      **Side-street Stop**

Direction	Movement	Demand Volume (vph)	Served Volume (vph)		Total Delay (sec/veh)		
			Average	Percent	Average	Std. Dev.	LOS
NB	Left Turn						
	Through	545	540	99.0%	2.5	0.4	A
	Right Turn	45	47	104.9%	1.6	0.8	A
	Subtotal	590	587	99.4%	2.5	0.4	A
SB	Left Turn	285	283	99.3%	8.5	1.2	A
	Through	224	223	99.6%	1.9	0.5	A
	Right Turn						
	Subtotal	509	506	99.4%	5.6	1.2	A
EB	Left Turn						
	Through						
	Right Turn						
	Subtotal						
WB	Left Turn	25	22	88.4%	70.1	29.9	F
	Through						
	Right Turn	485	475	97.8%	73.8	26.4	F
	Subtotal	510	497	97.4%	73.7	26.4	F
Total		1,609	1,590	98.8%	26.4	8.3	D

**Intersection 7**                      **Deer Valley Drive/Bonanza Drive**                      **Signal**

Direction	Movement	Demand Volume (vph)	Served Volume (vph)		Total Delay (sec/veh)		
			Average	Percent	Average	Std. Dev.	LOS
NB	Left Turn						
	Through	805	798	99.1%	32.8	6.7	C
	Right Turn	710	708	99.7%	25.2	6.5	C
	Subtotal	1,515	1,506	99.4%	29.3	6.2	C
SB	Left Turn	275	201	73.0%	19.9	3.8	B
	Through	512	415	81.1%	7.8	1.0	A
	Right Turn						
	Subtotal	787	616	78.2%	11.9	1.3	B
EB	Left Turn						
	Through						
	Right Turn						
	Subtotal						
WB	Left Turn	466	461	98.9%	26.2	4.0	C
	Through						
	Right Turn	145	150	103.7%	13.6	3.3	B
	Subtotal	611	611	100.0%	23.2	3.5	C
Total		2,913	2,733	93.8%	24.0	3.7	C

SimTraffic Post-Processor  
Average Results from 10 Runs  
Volume and Delay by Movement

Snow Park Village  
Opening Year Plus Project  
PM Peak Hour

**Intersection 8**                      **SR-224-Park Avenue/Empire Avenue-Deer Valley Drive**                      **Signal**

Direction	Movement	Demand Volume (vph)	Served Volume (vph)		Total Delay (sec/veh)		LOS
			Average	Percent	Average	Std. Dev.	
NB	Left Turn	35	35	99.4%	30.4	6.5	C
	Through	395	392	99.2%	55.8	4.1	E
	Right Turn	70	74	105.1%	34.2	10.3	C
	Subtotal	500	500	100.1%	50.9	4.8	D
SB	Left Turn	547	378	69.2%	234.7	15.2	F
	Through	365	237	65.0%	183.4	14.0	F
	Right Turn	445	301	67.5%	53.1	7.5	D
	Subtotal	1,357	916	67.5%	162.2	8.0	F
EB	Left Turn	765	516	67.4%	86.1	3.5	F
	Through	355	244	68.6%	56.4	7.9	E
	Right Turn	50	34	67.0%	42.7	9.9	D
	Subtotal	1,170	793	67.7%	75.3	4.1	E
WB	Left Turn	80	77	96.0%	87.3	25.5	F
	Through	310	356	114.8%	59.4	14.6	E
	Right Turn	690	654	94.8%	47.8	7.1	D
	Subtotal	1,080	1,087	100.6%	55.2	7.2	E
<b>Total</b>		<b>4,107</b>	<b>3,296</b>	<b>80.2%</b>	<b>87.8</b>	<b>2.3</b>	<b>F</b>

**Intersection 9**                      **Monitor Drive-Bonanza Drive/SR-248**                      **Signal**

Direction	Movement	Demand Volume (vph)	Served Volume (vph)		Total Delay (sec/veh)		LOS
			Average	Percent	Average	Std. Dev.	
NB	Left Turn	180	175	97.1%	40.9	7.6	D
	Through	90	92	101.9%	31.0	6.1	C
	Right Turn	525	471	89.8%	13.0	2.5	B
	Subtotal	795	738	92.8%	22.1	2.1	C
SB	Left Turn	100	94	94.4%	34.6	9.2	C
	Through	55	55	99.6%	42.8	7.3	D
	Right Turn	65	69	106.0%	5.9	1.2	A
	Subtotal	220	218	99.1%	27.8	4.6	C
EB	Left Turn	75	74	98.7%	14.5	2.2	B
	Through	635	645	101.5%	26.7	1.8	C
	Right Turn	150	145	96.9%	21.3	2.1	C
	Subtotal	860	864	100.5%	24.7	1.6	C
WB	Left Turn	251	250	99.5%	21.1	2.3	C
	Through	420	419	99.7%	11.3	2.6	B
	Right Turn	50	51	101.2%	6.4	2.1	A
	Subtotal	721	719	99.7%	14.3	1.5	B
<b>Total</b>		<b>2,596</b>	<b>2,539</b>	<b>97.8%</b>	<b>21.3</b>	<b>1.1</b>	<b>C</b>

# MOVEMENT SUMMARY

 Site: 101 [2024 Plus Project PM]

Deer Valley Drive / Marsac Avenue Roundabout  
 Site Category: (None)  
 Roundabout

Movement Performance - Vehicles												
Mov ID	Turn	Demand Total	Flows HV %	Deg. Satn v/c	Average Delay sec	Level of Service	95% Back of Queue Vehicles veh	Distance ft	Prop. Queued	Effective Stop Rate	Aver. No. Cycles	Average Speed mph
South: Marsac Avenue												
3	L2	1	100.0	0.398	15.9	LOS C	1.9	49.8	0.69	0.75	0.88	32.1
8	T1	460	3.0	0.398	10.8	LOS B	1.9	49.9	0.69	0.75	0.88	32.9
18b	R3	76	3.0	0.398	10.8	LOS B	1.9	49.9	0.69	0.75	0.88	31.3
Approach		536	3.2	0.398	10.8	LOS B	1.9	49.9	0.69	0.75	0.88	32.7
SouthEast: RoadName												
3bx	L3	51	3.0	0.657	18.0	LOS C	5.3	140.5	0.79	1.04	1.53	30.1
3ax	L1	20	100.0	0.657	22.8	LOS C	5.3	140.5	0.79	1.04	1.53	28.9
18ax	R1	838	3.0	0.657	17.8	LOS C	5.5	141.8	0.80	1.04	1.52	29.5
Approach		909	5.2	0.657	17.9	LOS C	5.5	141.8	0.80	1.04	1.52	29.5
North: Deer Valley Drive												
7u	U	242	3.0	0.704	12.8	LOS B	7.0	179.3	0.52	0.29	0.52	30.8
7a	L1	469	3.0	0.704	12.8	LOS B	7.0	179.3	0.52	0.29	0.52	29.9
4	T1	404	3.0	0.704	8.2	LOS A	7.0	179.3	0.36	0.19	0.36	33.2
14	R2	10	100.0	0.193	7.2	LOS A	0.8	21.7	0.23	0.11	0.23	34.5
Approach		1125	3.9	0.704	11.1	LOS B	7.0	179.3	0.46	0.25	0.46	31.2
West: Transit Center												
5	L2	5	100.0	0.118	16.5	LOS C	0.2	8.7	0.65	0.65	0.65	30.2
12a	R1	20	100.0	0.118	16.5	LOS C	0.2	8.7	0.65	0.65	0.65	29.7
12	R2	5	100.0	0.118	16.5	LOS C	0.2	8.7	0.65	0.65	0.65	29.1
Approach		30	100.0	0.118	16.5	LOS C	0.2	8.7	0.65	0.65	0.65	29.7
All Vehicles		2601	5.3	0.704	13.5	LOS B	7.0	179.3	0.63	0.63	0.92	30.9

Site Level of Service (LOS) Method: Delay & v/c (HCM 6). Site LOS Method is specified in the Parameter Settings dialog (Site tab).

Roundabout LOS Method: Same as Sign Control.

Vehicle movement LOS values are based on average delay and v/c ratio (degree of saturation) per movement.

LOS F will result if v/c > 1 irrespective of movement delay value (does not apply for approaches and intersection).

Intersection and Approach LOS values are based on average delay for all movements (v/c not used as specified in HCM 6).

Roundabout Capacity Model: US HCM 6.

HCM Delay Formula option is used. Control Delay does not include Geometric Delay since Exclude Geometric Delay option applies.

Gap-Acceptance Capacity: Traditional M1.

HV (%) values are calculated for All Movement Classes of All Heavy Vehicle Model Designation.

SIDRA INTERSECTION 8.0 | Copyright © 2000-2019 Akcelik and Associates Pty Ltd | sidrasolutions.com

Organisation: FEHR AND PEERS | Processed: Saturday, July 23, 2022 11:29:21 AM

Project: C:\Users\syamagata\Desktop\Projects\Snow Park Village\July 2022 TIS Update\SIDRA\DeerValleyDrRoundabout.sip8

**SimTraffic Post-Processor**  
**Average Results from 10 Runs**  
**Volume and Delay by Movement**

**Snow Park Village**  
**Opening Year Plus Project - Mitigated**  
**AM Peak Hour**

**Intersection 1**                      **Deer Valley Drive East/Doe Pass Road**                      **Signal**

Direction	Movement	Demand Volume (vph)	Served Volume (vph)		Total Delay (sec/veh)		
			Average	Percent	Average	Std. Dev.	LOS
NB	Left Turn	213	207	97.4%	13.7	1.5	B
	Through						
	Right Turn						
	Subtotal	213	207	97.4%	13.7	1.5	B
SB	Left Turn	290	292	100.6%	15.7	2.9	B
	Through						
	Right Turn						
	Subtotal	305	308	100.8%	15.4	2.9	B
EB	Left Turn	31	29	94.2%	28.4	6.1	C
	Through						
	Right Turn						
	Subtotal	31	29	94.2%	28.4	6.1	C
WB	Left Turn						
	Through						
	Right Turn						
	Subtotal						
<b>Total</b>		<b>549</b>	<b>544</b>	<b>99.1%</b>	<b>15.6</b>	<b>1.7</b>	<b>B</b>

**Intersection 2**                      **Deer Valley Drive West/Doe Pass Road**                      **Side-street Stop**

Direction	Movement	Demand Volume (vph)	Served Volume (vph)		Total Delay (sec/veh)		
			Average	Percent	Average	Std. Dev.	LOS
NB	Left Turn	20	19	94.5%	7.9	3.0	A
	Through						
	Right Turn						
	Subtotal	20	19	94.5%	7.9	3.0	A
SB	Left Turn						
	Through						
	Right Turn						
	Subtotal						
EB	Left Turn	529	538	101.7%	1.2	0.2	A
	Through						
	Right Turn						
	Subtotal	549	557	101.4%	1.2	0.2	A
WB	Left Turn	30	32	106.7%	0.9	0.3	A
	Through						
	Right Turn						
	Subtotal	30	32	106.7%	0.9	0.3	A
<b>Total</b>		<b>599</b>	<b>607</b>	<b>101.4%</b>	<b>1.4</b>	<b>0.2</b>	<b>A</b>

**SimTraffic Post-Processor**  
**Average Results from 10 Runs**  
**Volume and Delay by Movement**

**Snow Park Village**  
**Opening Year Plus Project - Mitigated**  
**AM Peak Hour**

**Intersection 3**                      **Deer Valley Drive East/Queen Esther Drive**                      **Side-street Stop**

Direction	Movement	Demand Volume (vph)	Served Volume (vph)		Total Delay (sec/veh)		
			Average	Percent	Average	Std. Dev.	LOS
NB	Left Turn						
	Through	269	268	99.7%	0.3	0.1	A
	Right Turn	20	22	111.0%	0.2	0.2	A
	Subtotal	289	290	100.5%	0.3	0.1	A
SB	Left Turn	50	51	101.0%	4.3	0.7	A
	Through	299	303	101.5%	0.5	0.1	A
	Right Turn						
	Subtotal	349	354	101.4%	1.0	0.1	A
EB	Left Turn						
	Through						
	Right Turn						
	Subtotal						
WB	Left Turn	20	20	99.0%	6.5	2.0	A
	Through						
	Right Turn	55	58	105.3%	6.0	1.2	A
	Subtotal	75	78	103.6%	6.2	1.2	A
<b>Total</b>		<b>713</b>	<b>722</b>	<b>101.3%</b>	<b>1.3</b>	<b>0.2</b>	<b>A</b>

**Intersection 4**                      **Solamere Drive/Deer Valley Drive East**                      **Side-street Stop**

Direction	Movement	Demand Volume (vph)	Served Volume (vph)		Total Delay (sec/veh)		
			Average	Percent	Average	Std. Dev.	LOS
NB	Left Turn						
	Through						
	Right Turn						
	Subtotal						
SB	Left Turn	25	25	99.6%	7.4	1.9	A
	Through						
	Right Turn	60	59	97.8%	7.1	1.5	A
	Subtotal	85	84	98.4%	7.0	1.1	A
EB	Left Turn	50	47	93.8%	6.5	1.5	A
	Through	324	327	101.0%	1.9	0.4	A
	Right Turn						
	Subtotal	374	374	100.0%	2.5	0.5	A
WB	Left Turn						
	Through	304	307	101.1%	0.4	0.1	A
	Right Turn	20	19	92.5%	0.2	0.1	A
	Subtotal	324	326	100.6%	0.4	0.1	A
<b>Total</b>		<b>783</b>	<b>784</b>	<b>100.1%</b>	<b>2.1</b>	<b>0.3</b>	<b>A</b>

**SimTraffic Post-Processor**  
**Average Results from 10 Runs**  
**Volume and Delay by Movement**

**Snow Park Village**  
**Opening Year Plus Project - Mitigated**  
**AM Peak Hour**

**Intersection 5**                      **Deer Valley Drive West/Deer Valley Drive East**                      **Signal**

Direction	Movement	Demand Volume (vph)	Served Volume (vph)		Total Delay (sec/veh)		
			Average	Percent	Average	Std. Dev.	LOS
NB	Left Turn						
	Through	35	32	92.0%	12.8	6.4	B
	Right Turn	15	18	120.7%	5.8	2.4	A
	Subtotal	50	50	100.6%	9.7	4.3	A
SB	Left Turn	359	354	98.5%	8.9	1.6	A
	Through	539	541	100.3%	7.0	1.0	A
	Right Turn						
	Subtotal	898	894	99.6%	7.7	1.0	A
EB	Left Turn						
	Through						
	Right Turn						
	Subtotal						
WB	Left Turn	10	10	103.0%	11.3	10.8	B
	Through						
	Right Turn	354	353	99.8%	4.2	0.8	A
	Subtotal	364	364	99.9%	4.7	0.7	A
<b>Total</b>		<b>1,312</b>	<b>1,308</b>	<b>99.7%</b>	<b>7.0</b>	<b>0.9</b>	<b>A</b>

**Intersection 7**                      **Deer Valley Drive/Bonanza Drive**                      **Signal**

Direction	Movement	Demand Volume (vph)	Served Volume (vph)		Total Delay (sec/veh)		
			Average	Percent	Average	Std. Dev.	LOS
NB	Left Turn						
	Through	304	307	101.1%	12.7	2.4	B
	Right Turn	181	186	102.8%	3.2	0.4	A
	Subtotal	485	493	101.7%	9.1	1.5	A
SB	Left Turn	115	99	85.9%	13.1	2.5	B
	Through	677	633	93.4%	9.5	0.9	A
	Right Turn						
	Subtotal	792	731	92.3%	10.0	0.8	B
EB	Left Turn						
	Through						
	Right Turn						
	Subtotal						
WB	Left Turn	602	614	101.9%	16.9	1.7	B
	Through						
	Right Turn	215	208	96.7%	6.1	1.4	A
	Subtotal	817	822	100.6%	14.2	1.6	B
<b>Total</b>		<b>2,094</b>	<b>2,046</b>	<b>97.7%</b>	<b>11.5</b>	<b>0.9</b>	<b>B</b>



**SimTraffic Post-Processor**  
**Average Results from 10 Runs**  
**Volume and Delay by Movement**

**Snow Park Village**  
**Opening Year Plus Project - Mitigated**  
**AM Peak Hour**

**Intersection 8 SR-224-Park Avenue/Empire Avenue-Deer Valley Drive Signal**

Direction	Movement	Demand Volume (vph)	Served Volume (vph)		Total Delay (sec/veh)		
			Average	Percent	Average	Std. Dev.	LOS
NB	Left Turn	55	56	102.4%	31.7	7.7	C
	Through	195	193	98.8%	51.7	4.2	D
	Right Turn	75	72	95.3%	21.0	6.1	C
	Subtotal	325	321	98.6%	41.5	3.4	D
SB	Left Turn	517	415	80.2%	213.1	13.2	F
	Through	170	135	79.1%	183.3	15.2	F
	Right Turn	1,065	852	80.0%	63.6	12.3	E
	Subtotal	1,752	1,401	80.0%	120.7	5.5	F
EB	Left Turn	385	383	99.5%	48.6	8.0	D
	Through	240	238	99.1%	30.7	8.5	C
	Right Turn	25	29	115.6%	23.9	14.8	C
	Subtotal	650	650	100.0%	41.1	6.9	D
WB	Left Turn	50	48	96.4%	83.5	12.5	F
	Through	325	352	108.3%	61.7	17.7	E
	Right Turn	254	255	100.5%	10.9	2.1	B
	Subtotal	629	656	104.2%	44.8	11.9	D
Total		3,356	3,027	90.2%	78.3	3.6	E

**Intersection 9 Monitor Drive-Bonanza Drive/SR-248 Signal**

Direction	Movement	Demand Volume (vph)	Served Volume (vph)		Total Delay (sec/veh)		
			Average	Percent	Average	Std. Dev.	LOS
NB	Left Turn	65	61	94.2%	22.5	4.0	C
	Through	30	27	89.7%	22.2	8.0	C
	Right Turn	126	122	96.9%	3.2	0.6	A
	Subtotal	221	210	95.1%	10.8	1.4	B
SB	Left Turn	60	58	96.7%	19.2	3.2	B
	Through	75	77	102.8%	23.1	3.8	C
	Right Turn	30	31	102.7%	4.3	1.0	A
	Subtotal	165	166	100.5%	18.4	3.0	B
EB	Left Turn	25	24	97.2%	13.2	4.3	B
	Through	250	257	102.6%	18.2	3.0	B
	Right Turn	100	99	99.1%	9.5	2.0	A
	Subtotal	375	380	101.3%	15.6	2.2	B
WB	Left Turn	322	318	98.8%	14.0	1.4	B
	Through	350	358	102.2%	8.0	1.6	A
	Right Turn	50	50	100.4%	6.2	2.5	A
	Subtotal	722	726	100.6%	10.5	1.1	B
Total		1,483	1,482	99.9%	12.7	0.7	B

**SimTraffic Post-Processor**  
**Average Results from 10 Runs**  
**Volume and Delay by Movement**

**Snow Park Village**  
**Opening Year Plus Project - Mitigated**  
**PM Peak Hour**

**Intersection 1**                      **Deer Valley Drive East/Doe Pass Road**                      **Signal**

Direction	Movement	Demand Volume (vph)	Served Volume (vph)		Total Delay (sec/veh)		
			Average	Percent	Average	Std. Dev.	LOS
NB	Left Turn	714	704	98.6%	4.9	2.2	A
	Through						
	Right Turn						
	Subtotal	714	704	98.6%	4.9	2.2	A
SB	Left Turn	240	247	103.1%	3.4	1.9	A
	Through						
	Right Turn						
	Subtotal	255	265	104.0%	3.3	1.8	A
EB	Left Turn	26	26	101.2%	13.8	6.1	B
	Through						
	Right Turn						
	Subtotal	26	26	101.2%	13.8	6.1	B
WB	Left Turn						
	Through						
	Right Turn						
	Subtotal						
<b>Total</b>		<b>995</b>	<b>995</b>	<b>100.0%</b>	<b>4.7</b>	<b>2.0</b>	<b>A</b>

**Intersection 2**                      **Deer Valley Drive West/Doe Pass Road**                      **Side-street Stop**

Direction	Movement	Demand Volume (vph)	Served Volume (vph)		Total Delay (sec/veh)		
			Average	Percent	Average	Std. Dev.	LOS
NB	Left Turn	20	19	97.0%	6.6	1.9	A
	Through						
	Right Turn						
	Subtotal	20	19	97.0%	6.6	1.9	A
SB	Left Turn						
	Through						
	Right Turn						
	Subtotal						
EB	Left Turn	129	132	102.3%	0.3	0.2	A
	Through						
	Right Turn						
	Subtotal	149	152	101.8%	0.3	0.1	A
WB	Left Turn	231	232	100.5%	2.1	0.1	A
	Through						
	Right Turn						
	Subtotal	231	232	100.5%	2.1	0.1	A
<b>Total</b>		<b>400</b>	<b>403</b>	<b>100.8%</b>	<b>1.6</b>	<b>0.2</b>	<b>A</b>

**SimTraffic Post-Processor**  
**Average Results from 10 Runs**  
**Volume and Delay by Movement**

**Snow Park Village**  
**Opening Year Plus Project - Mitigated**  
**PM Peak Hour**

**Intersection 3**                      **Deer Valley Drive East/Queen Esther Drive**                      **Side-street Stop**

Direction	Movement	Demand Volume (vph)	Served Volume (vph)		Total Delay (sec/veh)		
			Average	Percent	Average	Std. Dev.	LOS
NB	Left Turn						
	Through	744	746	100.2%	0.6	0.1	A
	Right Turn	30	28	93.0%	0.5	0.2	A
	Subtotal	774	773	99.9%	0.6	0.1	A
SB	Left Turn	85	85	100.1%	7.7	1.1	A
	Through	275	287	104.3%	0.4	0.1	A
	Right Turn						
	Subtotal	360	372	103.3%	2.0	0.4	A
EB	Left Turn						
	Through						
	Right Turn						
	Subtotal						
WB	Left Turn	30	31	101.7%	16.0	5.6	C
	Through						
	Right Turn	60	60	99.7%	10.7	2.5	B
	Subtotal	90	90	100.3%	12.6	2.7	B
<b>Total</b>		<b>1,224</b>	<b>1,236</b>	<b>100.9%</b>	<b>1.9</b>	<b>0.2</b>	<b>A</b>

**Intersection 4**                      **Solamere Drive/Deer Valley Drive East**                      **Side-street Stop**

Direction	Movement	Demand Volume (vph)	Served Volume (vph)		Total Delay (sec/veh)		
			Average	Percent	Average	Std. Dev.	LOS
NB	Left Turn						
	Through						
	Right Turn						
	Subtotal						
SB	Left Turn	20	19	93.5%	17.9	7.6	C
	Through						
	Right Turn	80	80	100.4%	13.7	3.7	B
	Subtotal	100	99	99.0%	15.0	3.7	B
EB	Left Turn	90	84	93.2%	11.1	2.2	B
	Through	340	349	102.7%	2.1	0.5	A
	Right Turn						
	Subtotal	430	433	100.7%	3.7	0.5	A
WB	Left Turn						
	Through	769	769	99.9%	1.0	0.1	A
	Right Turn	35	34	97.4%	0.6	0.1	A
	Subtotal	804	803	99.8%	1.0	0.1	A
<b>Total</b>		<b>1,334</b>	<b>1,335</b>	<b>100.1%</b>	<b>2.8</b>	<b>0.4</b>	<b>A</b>

**SimTraffic Post-Processor**  
**Average Results from 10 Runs**  
**Volume and Delay by Movement**

**Snow Park Village**  
**Opening Year Plus Project - Mitigated**  
**PM Peak Hour**

**Intersection 5**                      **Deer Valley Drive West/Deer Valley Drive East**                      **Signal**

Direction	Movement	Demand Volume (vph)	Served Volume (vph)		Total Delay (sec/veh)		
			Average	Percent	Average	Std. Dev.	LOS
NB	Left Turn						
	Through	206	204	99.2%	36.1	4.5	D
	Right Turn	45	47	104.2%	26.1	5.7	C
	Subtotal	251	251	100.1%	34.2	3.6	C
SB	Left Turn	385	386	100.3%	10.1	2.4	B
	Through	124	124	100.3%	3.5	1.1	A
	Right Turn						
	Subtotal	509	510	100.3%	8.5	2.1	A
EB	Left Turn						
	Through						
	Right Turn						
	Subtotal						
WB	Left Turn	25	27	106.4%	47.1	14.7	D
	Through						
	Right Turn	824	816	99.1%	14.4	2.6	B
	Subtotal	849	843	99.3%	15.4	2.5	B
<b>Total</b>		<b>1,609</b>	<b>1,605</b>	<b>99.7%</b>	<b>16.2</b>	<b>1.6</b>	<b>B</b>

**Intersection 7**                      **Deer Valley Drive/Bonanza Drive**                      **Signal**

Direction	Movement	Demand Volume (vph)	Served Volume (vph)		Total Delay (sec/veh)		
			Average	Percent	Average	Std. Dev.	LOS
NB	Left Turn						
	Through	805	786	97.6%	30.7	5.5	C
	Right Turn	710	721	101.6%	25.2	10.6	C
	Subtotal	1,515	1,507	99.5%	28.1	7.9	C
SB	Left Turn	275	197	71.7%	20.7	2.3	C
	Through	512	407	79.6%	9.9	1.9	A
	Right Turn						
	Subtotal	787	605	76.8%	13.6	1.7	B
EB	Left Turn						
	Through						
	Right Turn						
	Subtotal						
WB	Left Turn	466	461	98.9%	25.0	3.6	C
	Through						
	Right Turn	145	149	102.8%	12.7	4.6	B
	Subtotal	611	610	99.9%	22.2	3.4	C
<b>Total</b>		<b>2,913</b>	<b>2,722</b>	<b>93.4%</b>	<b>23.6</b>	<b>4.9</b>	<b>C</b>

**SimTraffic Post-Processor**  
**Average Results from 10 Runs**  
**Volume and Delay by Movement**

**Snow Park Village**  
**Opening Year Plus Project - Mitigated**  
**PM Peak Hour**

**Intersection 8 SR-224-Park Avenue/Empire Avenue-Deer Valley Drive Signal**

Direction	Movement	Demand Volume (vph)	Served Volume (vph)		Total Delay (sec/veh)		
			Average	Percent	Average	Std. Dev.	LOS
NB	Left Turn	35	37	106.6%	34.5	9.5	C
	Through	395	394	99.8%	49.1	4.6	D
	Right Turn	70	68	97.3%	34.6	8.5	C
	Subtotal	500	500	99.9%	46.1	4.2	D
SB	Left Turn	547	383	69.9%	235.5	15.7	F
	Through	365	248	67.9%	179.1	10.5	F
	Right Turn	445	300	67.3%	48.7	5.5	D
	Subtotal	1,357	930	68.5%	161.5	7.3	F
EB	Left Turn	765	523	68.3%	87.5	5.4	F
	Through	355	236	66.6%	67.4	14.1	E
	Right Turn	50	36	72.4%	60.4	15.7	E
	Subtotal	1,170	795	68.0%	80.8	8.1	F
WB	Left Turn	80	76	94.5%	75.6	18.7	E
	Through	310	344	110.9%	54.3	10.4	D
	Right Turn	690	658	95.3%	47.3	3.0	D
	Subtotal	1,080	1,077	99.7%	51.5	5.0	D
Total		4,107	3,302	80.4%	88.3	3.8	F

**Intersection 9 Monitor Drive-Bonanza Drive/SR-248 Signal**

Direction	Movement	Demand Volume (vph)	Served Volume (vph)		Total Delay (sec/veh)		
			Average	Percent	Average	Std. Dev.	LOS
NB	Left Turn	180	166	92.1%	41.0	12.5	D
	Through	90	96	107.1%	31.8	5.3	C
	Right Turn	525	496	94.5%	13.3	3.1	B
	Subtotal	795	758	95.4%	21.7	4.0	C
SB	Left Turn	100	100	100.1%	34.9	3.9	C
	Through	55	57	102.9%	40.1	8.9	D
	Right Turn	65	62	95.7%	5.8	0.8	A
	Subtotal	220	219	99.5%	28.2	4.2	C
EB	Left Turn	75	71	95.1%	17.2	3.9	B
	Through	635	642	101.1%	30.1	4.0	C
	Right Turn	150	156	103.8%	25.5	6.7	C
	Subtotal	860	869	101.0%	28.3	4.1	C
WB	Left Turn	251	256	101.8%	20.7	2.9	C
	Through	420	422	100.5%	12.0	2.1	B
	Right Turn	50	49	98.6%	8.9	4.2	A
	Subtotal	721	727	100.8%	14.7	1.8	B
Total		2,596	2,572	99.1%	22.5	2.5	C

**SimTraffic Post-Processor**  
**Average Results from 10 Runs**  
**Volume and Delay by Movement**

**Snow Park Village**  
**2040 Background**  
**AM Peak Hour**

**Intersection 3**                      **Deer Valley Drive East/Queen Esther Drive**                      **Side-street Stop**

Direction	Movement	Demand Volume (vph)	Served Volume (vph)		Total Delay (sec/veh)		
			Average	Percent	Average	Std. Dev.	LOS
NB	Left Turn						
	Through	105	110	104.8%	0.3	0.2	A
	Right Turn	20	20	100.0%	0.1	0.2	A
	Subtotal	125	130	104.0%	0.3	0.2	A
SB	Left Turn	50	49	97.6%	3.9	0.6	A
	Through	160	169	105.3%	1.2	0.4	A
	Right Turn						
	Subtotal	210	217	103.5%	1.8	0.3	A
EB	Left Turn						
	Through						
	Right Turn						
	Subtotal						
WB	Left Turn	20	21	104.0%	6.9	2.0	A
	Through						
	Right Turn	55	56	100.9%	5.1	0.4	A
	Subtotal	75	76	101.7%	5.5	0.5	A
<b>Total</b>		<b>410</b>	<b>424</b>	<b>103.3%</b>	<b>2.1</b>	<b>0.3</b>	<b>A</b>

**Intersection 4**                      **Solamere Drive/Deer Valley Drive East**                      **Side-street Stop**

Direction	Movement	Demand Volume (vph)	Served Volume (vph)		Total Delay (sec/veh)		
			Average	Percent	Average	Std. Dev.	LOS
NB	Left Turn						
	Through						
	Right Turn						
	Subtotal						
SB	Left Turn	25	23	92.0%	7.5	2.2	A
	Through						
	Right Turn	60	64	106.5%	5.6	0.7	A
	Subtotal	85	87	102.2%	6.1	0.7	A
EB	Left Turn	50	49	97.8%	4.5	0.9	A
	Through	185	195	105.6%	1.5	0.4	A
	Right Turn						
	Subtotal	235	244	103.9%	2.2	0.4	A
WB	Left Turn						
	Through	140	145	103.7%	0.9	0.2	A
	Right Turn	20	19	97.0%	1.3	0.6	A
	Subtotal	160	165	102.9%	1.0	0.2	A
<b>Total</b>		<b>480</b>	<b>496</b>	<b>103.3%</b>	<b>2.5</b>	<b>0.3</b>	<b>A</b>

**SimTraffic Post-Processor**  
**Average Results from 10 Runs**  
**Volume and Delay by Movement**

**Snow Park Village**  
**2040 Background**  
**AM Peak Hour**

**Intersection 5**                      **Deer Valley Drive West/Deer Valley Drive East**                      **Side-street Stop**

Direction	Movement	Demand Volume (vph)	Served Volume (vph)		Total Delay (sec/veh)		
			Average	Percent	Average	Std. Dev.	LOS
NB	Left Turn						
	Through	185	188	101.4%	1.6	0.5	A
	Right Turn	15	17	110.7%	1.2	0.8	A
	Subtotal	200	204	102.1%	1.5	0.4	A
SB	Left Turn	220	227	103.3%	6.6	0.8	A
	Through	740	735	99.4%	4.3	0.4	A
	Right Turn						
	Subtotal	960	963	100.3%	4.8	0.4	A
EB	Left Turn						
	Through						
	Right Turn						
	Subtotal						
WB	Left Turn	10	11	106.0%	17.3	16.7	C
	Through						
	Right Turn	190	195	102.7%	4.8	0.4	A
	Subtotal	200	206	102.9%	5.5	0.9	A
<b>Total</b>		<b>1,360</b>	<b>1,373</b>	<b>100.9%</b>	<b>4.4</b>	<b>0.3</b>	<b>A</b>

**Intersection 7**                      **Deer Valley Drive/Bonanza Drive**                      **Signal**

Direction	Movement	Demand Volume (vph)	Served Volume (vph)		Total Delay (sec/veh)		
			Average	Percent	Average	Std. Dev.	LOS
NB	Left Turn						
	Through	275	273	99.4%	28.7	16.6	C
	Right Turn	200	195	97.7%	3.4	1.0	A
	Subtotal	475	469	98.7%	18.4	9.9	B
SB	Left Turn	125	102	81.6%	14.8	3.6	B
	Through	655	546	83.3%	10.3	1.2	B
	Right Turn						
	Subtotal	780	648	83.0%	11.0	1.2	B
EB	Left Turn						
	Through						
	Right Turn						
	Subtotal						
WB	Left Turn	700	707	101.0%	24.9	7.6	C
	Through						
	Right Turn	225	220	97.7%	14.7	9.5	B
	Subtotal	925	927	100.2%	22.5	7.9	C
<b>Total</b>		<b>2,180</b>	<b>2,043</b>	<b>93.7%</b>	<b>18.0</b>	<b>5.9</b>	<b>B</b>



**SimTraffic Post-Processor**  
**Average Results from 10 Runs**  
**Volume and Delay by Movement**

**Snow Park Village**  
**2040 Background**  
**AM Peak Hour**

**Intersection 8**

**SR-224-Park Avenue/Empire Avenue-Deer Valley Drive**

**Signal**

Direction	Movement	Demand Volume (vph)	Served Volume (vph)		Total Delay (sec/veh)		LOS
			Average	Percent	Average	Std. Dev.	
NB	Left Turn	95	98	102.8%	31.5	5.0	C
	Through	195	194	99.3%	52.6	5.4	D
	Right Turn	70	69	98.9%	24.0	9.8	C
	Subtotal	360	361	100.1%	41.3	4.6	D
SB	Left Turn	480	305	63.5%	80.6	11.6	F
	Through	170	111	65.1%	76.7	11.0	E
	Right Turn	1,565	1,004	64.1%	122.1	2.4	F
	Subtotal	2,215	1,419	64.1%	109.3	3.2	F
EB	Left Turn	580	545	94.0%	73.7	6.0	E
	Through	360	335	93.0%	50.4	7.6	D
	Right Turn	45	43	95.8%	39.4	8.5	D
	Subtotal	985	923	93.7%	63.6	6.0	E
WB	Left Turn	50	44	88.6%	105.3	10.8	F
	Through	425	412	96.8%	99.5	8.2	F
	Right Turn	215	192	89.3%	14.7	4.5	B
	Subtotal	690	648	93.9%	74.9	6.9	E
Total		4,250	3,350	78.8%	83.0	2.5	F

**Intersection 9**

**Monitor Drive-Bonanza Drive/SR-248**

**Signal**

Direction	Movement	Demand Volume (vph)	Served Volume (vph)		Total Delay (sec/veh)		LOS
			Average	Percent	Average	Std. Dev.	
NB	Left Turn	75	67	89.3%	29.5	5.9	C
	Through	30	31	102.0%	25.6	4.5	C
	Right Turn	120	111	92.2%	4.7	1.3	A
	Subtotal	225	208	92.5%	15.7	2.7	B
SB	Left Turn	65	65	99.4%	27.1	7.1	C
	Through	75	74	98.0%	29.9	3.3	C
	Right Turn	35	36	102.0%	4.8	1.3	A
	Subtotal	175	174	99.3%	23.6	3.9	C
EB	Left Turn	25	25	98.4%	13.1	4.4	B
	Through	340	342	100.6%	21.6	2.7	C
	Right Turn	110	112	101.4%	12.9	3.8	B
	Subtotal	475	478	100.7%	19.0	2.7	B
WB	Left Turn	345	352	102.1%	17.2	2.1	B
	Through	475	473	99.6%	9.5	1.4	A
	Right Turn	55	57	103.5%	5.9	2.7	A
	Subtotal	875	883	100.9%	12.2	1.7	B
Total		1,750	1,743	99.6%	15.7	1.7	B

# MOVEMENT SUMMARY

 Site: 101 [2040 BG AM]

Deer Valley Drive / Marsac Avenue Roundabout  
 Site Category: (None)  
 Roundabout

Movement Performance - Vehicles												
Mov ID	Turn	Demand Total	Flows HV %	Deg. Satn v/c	Average Delay sec	Level of Service	95% Back of Queue Vehicles veh	Distance ft	Prop. Queued	Effective Stop Rate	Aver. No. Cycles	Average Speed mph
South: Marsac Avenue												
3	L2	5	100.0	0.219	16.5	LOS C	0.7	19.8	0.67	0.67	0.67	32.8
8	T1	133	3.0	0.219	10.0	LOS A	0.8	20.0	0.67	0.67	0.67	33.1
18b	R3	85	3.0	0.219	9.9	LOS A	0.8	20.0	0.68	0.68	0.68	31.5
Approach		223	5.3	0.219	10.1	LOS B	0.8	20.0	0.67	0.67	0.67	32.5
SouthEast: RoadName												
3bx	L3	48	3.0	0.175	4.7	LOS A	0.7	18.6	0.32	0.20	0.32	35.6
3ax	L1	21	100.0	0.175	7.6	LOS A	0.7	18.6	0.32	0.20	0.32	34.1
18ax	R1	319	3.0	0.175	4.6	LOS A	0.8	19.2	0.33	0.20	0.33	35.3
Approach		388	8.3	0.175	4.8	LOS A	0.8	19.2	0.33	0.20	0.33	35.3
North: Deer Valley Drive												
7u	U	27	3.0	0.877	23.2	LOS C	14.5	370.9	0.90	0.53	0.90	27.2
7a	L1	947	3.0	0.877	23.2	LOS C	14.5	370.9	0.90	0.53	0.90	26.5
4	T1	399	3.0	0.877	10.9	LOS B	14.5	370.9	0.46	0.26	0.46	32.3
14	R2	16	100.0	0.240	7.7	LOS A	1.1	28.2	0.25	0.13	0.25	34.2
Approach		1388	4.1	0.877	19.4	LOS C	14.5	370.9	0.77	0.44	0.77	28.0
West: Transit Center												
5	L2	5	100.0	0.234	24.0	LOS C	0.4	17.2	0.74	0.75	0.77	27.5
12a	R1	27	100.0	0.234	24.0	LOS C	0.4	17.2	0.74	0.75	0.77	27.2
12	R2	16	100.0	0.234	24.0	LOS C	0.4	17.2	0.74	0.75	0.77	26.6
Approach		48	100.0	0.234	24.0	LOS C	0.4	17.2	0.74	0.75	0.77	27.0
All Vehicles		2048	7.3	0.877	15.8	LOS C	14.5	370.9	0.67	0.43	0.67	29.6

Site Level of Service (LOS) Method: Delay & v/c (HCM 6). Site LOS Method is specified in the Parameter Settings dialog (Site tab).

Roundabout LOS Method: Same as Sign Control.

Vehicle movement LOS values are based on average delay and v/c ratio (degree of saturation) per movement.

LOS F will result if v/c > 1 irrespective of movement delay value (does not apply for approaches and intersection).

Intersection and Approach LOS values are based on average delay for all movements (v/c not used as specified in HCM 6).

Roundabout Capacity Model: US HCM 6.

HCM Delay Formula option is used. Control Delay does not include Geometric Delay since Exclude Geometric Delay option applies.

Gap-Acceptance Capacity: Traditional M1.

HV (%) values are calculated for All Movement Classes of All Heavy Vehicle Model Designation.

**SIDRA INTERSECTION 8.0 | Copyright © 2000-2019 Akcelik and Associates Pty Ltd | sidrasolutions.com**

Organisation: FEHR AND PEERS | Processed: Friday, July 22, 2022 4:18:58 PM

Project: C:\Users\syamagata\Desktop\Projects\Snow Park Village\July 2022 TIS Update\SIDRA\DeerValleyDrRoundabout.sip8

**SimTraffic Post-Processor**  
**Average Results from 10 Runs**  
**Volume and Delay by Movement**

**Snow Park Village**  
**2040 Background**  
**PM Peak Hour**

**Intersection 3**                      **Deer Valley Drive East/Queen Esther Drive**                      **Side-street Stop**

Direction	Movement	Demand Volume (vph)	Served Volume (vph)		Total Delay (sec/veh)		
			Average	Percent	Average	Std. Dev.	LOS
NB	Left Turn						
	Through	370	385	104.1%	1.2	0.2	A
	Right Turn	30	32	107.7%	0.6	0.5	A
	Subtotal	400	418	104.4%	1.2	0.2	A
SB	Left Turn	85	88	103.6%	5.2	0.6	A
	Through	125	121	97.0%	1.8	0.5	A
	Right Turn						
	Subtotal	210	209	99.7%	3.2	0.4	A
EB	Left Turn						
	Through						
	Right Turn						
	Subtotal						
WB	Left Turn	30	30	98.3%	9.1	3.8	A
	Through						
	Right Turn	60	63	104.8%	7.3	2.1	A
	Subtotal	90	92	102.7%	8.1	2.2	A
<b>Total</b>		<b>700</b>	<b>719</b>	<b>102.8%</b>	<b>2.6</b>	<b>0.5</b>	<b>A</b>

**Intersection 4**                      **Solamere Drive/Deer Valley Drive East**                      **Side-street Stop**

Direction	Movement	Demand Volume (vph)	Served Volume (vph)		Total Delay (sec/veh)		
			Average	Percent	Average	Std. Dev.	LOS
NB	Left Turn						
	Through						
	Right Turn						
	Subtotal						
SB	Left Turn	20	21	104.5%	15.0	6.1	B
	Through						
	Right Turn	80	79	98.1%	8.5	1.7	A
	Subtotal	100	99	99.4%	10.1	3.0	B
EB	Left Turn	90	94	104.8%	6.4	1.0	A
	Through	190	186	97.7%	2.1	0.5	A
	Right Turn						
	Subtotal	280	280	100.0%	3.6	0.6	A
WB	Left Turn						
	Through	395	412	104.4%	1.3	0.2	A
	Right Turn	35	37	105.1%	1.4	0.3	A
	Subtotal	430	449	104.4%	1.3	0.2	A
<b>Total</b>		<b>810</b>	<b>828</b>	<b>102.3%</b>	<b>3.0</b>	<b>0.4</b>	<b>A</b>

**SimTraffic Post-Processor**  
**Average Results from 10 Runs**  
**Volume and Delay by Movement**

**Snow Park Village**  
**2040 Background**  
**PM Peak Hour**

**Intersection 5**                      **Deer Valley Drive West/Deer Valley Drive East**                      **Side-street Stop**

Direction	Movement	Demand Volume (vph)	Served Volume (vph)		Total Delay (sec/veh)		
			Average	Percent	Average	Std. Dev.	LOS
NB	Left Turn						
	Through	645	641	99.4%	4.0	0.7	A
	Right Turn	45	48	107.6%	2.9	0.7	A
	Subtotal	690	690	100.0%	3.9	0.7	A
SB	Left Turn	235	232	98.6%	9.3	1.6	A
	Through	245	246	100.2%	1.8	0.4	A
	Right Turn						
	Subtotal	480	477	99.4%	5.4	1.0	A
EB	Left Turn						
	Through						
	Right Turn						
	Subtotal						
WB	Left Turn	25	27	106.4%	107.4	23.1	F
	Through						
	Right Turn	450	447	99.4%	111.6	22.5	F
	Subtotal	475	474	99.7%	111.5	22.3	F
<b>Total</b>		<b>1,645</b>	<b>1,641</b>	<b>99.7%</b>	<b>35.5</b>	<b>4.8</b>	<b>E</b>

**Intersection 7**                      **Deer Valley Drive/Bonanza Drive**                      **Signal**

Direction	Movement	Demand Volume (vph)	Served Volume (vph)		Total Delay (sec/veh)		
			Average	Percent	Average	Std. Dev.	LOS
NB	Left Turn						
	Through	785	771	98.2%	78.6	50.6	E
	Right Turn	820	786	95.9%	92.1	74.1	F
	Subtotal	1,605	1,558	97.0%	85.7	62.8	F
SB	Left Turn	290	189	65.2%	20.6	2.6	C
	Through	470	335	71.2%	8.6	2.2	A
	Right Turn						
	Subtotal	760	524	68.9%	12.8	2.1	B
EB	Left Turn						
	Through						
	Right Turn						
	Subtotal						
WB	Left Turn	530	526	99.2%	37.2	15.3	D
	Through						
	Right Turn	150	144	95.8%	20.4	8.7	C
	Subtotal	680	670	98.5%	33.5	14.1	C
<b>Total</b>		<b>3,045</b>	<b>2,751</b>	<b>90.3%</b>	<b>59.2</b>	<b>37.7</b>	<b>E</b>

**SimTraffic Post-Processor**  
**Average Results from 10 Runs**  
**Volume and Delay by Movement**

**Snow Park Village**  
**2040 Background**  
**PM Peak Hour**

**Intersection 8**                      **SR-224-Park Avenue/Empire Avenue-Deer Valley Drive**                      **Signal**

Direction	Movement	Demand Volume (vph)	Served Volume (vph)		Total Delay (sec/veh)		
			Average	Percent	Average	Std. Dev.	LOS
NB	Left Turn	70	71	101.3%	35.7	8.6	D
	Through	395	396	100.4%	54.8	5.5	D
	Right Turn	70	74	105.0%	41.2	9.5	D
	Subtotal	535	541	101.1%	50.6	5.6	D
SB	Left Turn	495	355	71.8%	216.3	16.0	F
	Through	365	259	71.1%	177.6	10.4	F
	Right Turn	720	524	72.7%	55.9	7.5	E
	Subtotal	1,580	1,138	72.0%	135.6	10.3	F
EB	Left Turn	1,190	527	44.3%	96.1	7.7	F
	Through	445	201	45.2%	75.2	18.2	E
	Right Turn	70	32	45.9%	64.1	23.0	E
	Subtotal	1,705	761	44.6%	89.7	9.7	F
WB	Left Turn	75	64	85.7%	122.1	17.2	F
	Through	405	396	97.7%	88.9	5.2	F
	Right Turn	640	546	85.3%	37.1	5.8	D
	Subtotal	1,120	1,006	89.8%	63.6	3.7	E
<b>Total</b>		<b>4,940</b>	<b>3,445</b>	<b>69.7%</b>	<b>90.0</b>	<b>3.0</b>	<b>F</b>

**Intersection 9**                      **Monitor Drive-Bonanza Drive/SR-248**                      **Signal**

Direction	Movement	Demand Volume (vph)	Served Volume (vph)		Total Delay (sec/veh)		
			Average	Percent	Average	Std. Dev.	LOS
NB	Left Turn	210	181	86.3%	51.9	15.5	D
	Through	90	85	94.4%	43.4	12.4	D
	Right Turn	565	508	89.8%	18.1	4.9	B
	Subtotal	865	774	89.5%	29.4	7.6	C
SB	Left Turn	105	103	97.7%	35.5	11.6	D
	Through	55	56	101.3%	47.5	6.9	D
	Right Turn	75	76	101.9%	6.4	1.6	A
	Subtotal	235	235	99.9%	28.6	4.7	C
EB	Left Turn	85	90	105.8%	18.2	2.9	B
	Through	865	882	101.9%	37.7	7.4	D
	Right Turn	175	172	98.2%	34.7	9.8	C
	Subtotal	1,125	1,144	101.6%	35.8	7.3	D
WB	Left Turn	255	252	98.6%	25.9	2.6	C
	Through	570	561	98.4%	12.7	1.8	B
	Right Turn	55	54	98.9%	8.3	2.7	A
	Subtotal	880	867	98.5%	16.4	1.3	B
<b>Total</b>		<b>3,105</b>	<b>3,019</b>	<b>97.2%</b>	<b>28.1</b>	<b>3.0</b>	<b>C</b>

# MOVEMENT SUMMARY

 Site: 101 [2040 BG PM]

Deer Valley Drive / Marsac Avenue Roundabout  
 Site Category: (None)  
 Roundabout

Movement Performance - Vehicles												
Mov ID	Turn	Demand Total	Flows HV %	Deg. Satn v/c	Average Delay sec	Level of Service	95% Back of Queue Vehicles veh	Distance ft	Prop. Queued	Effective Stop Rate	Aver. No. Cycles	Average Speed mph
South: Marsac Avenue												
3	L2	1	100.0	0.402	15.4	LOS C	2.0	51.3	0.68	0.74	0.87	32.2
8	T1	475	3.0	0.402	10.6	LOS B	2.0	51.3	0.68	0.74	0.87	33.0
18b	R3	86	3.0	0.402	10.6	LOS B	2.0	51.3	0.68	0.74	0.87	31.4
Approach		562	3.2	0.402	10.6	LOS B	2.0	51.3	0.68	0.74	0.87	32.8
SouthEast: RoadName												
3bx	L3	51	3.0	0.681	19.2	LOS C	5.8	151.3	0.81	1.08	1.61	29.7
3ax	L1	15	100.0	0.681	24.1	LOS C	5.8	151.3	0.81	1.08	1.61	28.4
18ax	R1	864	3.0	0.681	19.1	LOS C	6.0	152.4	0.82	1.08	1.61	29.1
Approach		929	4.6	0.681	19.2	LOS C	6.0	152.4	0.82	1.08	1.61	29.1
North: Deer Valley Drive												
7u	U	247	3.0	0.695	12.5	LOS B	6.9	176.1	0.48	0.26	0.48	31.0
7a	L1	434	3.0	0.695	12.5	LOS B	6.9	176.1	0.48	0.26	0.48	30.1
4	T1	429	3.0	0.695	8.3	LOS A	6.9	176.1	0.34	0.17	0.34	33.1
14	R2	10	100.0	0.190	7.1	LOS A	0.8	21.5	0.22	0.10	0.22	34.5
Approach		1121	3.9	0.695	10.8	LOS B	6.9	176.1	0.43	0.22	0.43	31.4
West: Transit Center												
5	L2	5	100.0	0.098	16.0	LOS C	0.2	7.2	0.65	0.65	0.65	30.3
12a	R1	15	100.0	0.098	16.0	LOS C	0.2	7.2	0.65	0.65	0.65	29.9
12	R2	5	100.0	0.098	16.0	LOS C	0.2	7.2	0.65	0.65	0.65	29.2
Approach		25	100.0	0.098	16.0	LOS C	0.2	7.2	0.65	0.65	0.65	29.8
All Vehicles		2637	4.9	0.695	13.8	LOS B	6.9	176.1	0.62	0.64	0.94	30.8

Site Level of Service (LOS) Method: Delay & v/c (HCM 6). Site LOS Method is specified in the Parameter Settings dialog (Site tab).

Roundabout LOS Method: Same as Sign Control.

Vehicle movement LOS values are based on average delay and v/c ratio (degree of saturation) per movement.

LOS F will result if v/c > 1 irrespective of movement delay value (does not apply for approaches and intersection).

Intersection and Approach LOS values are based on average delay for all movements (v/c not used as specified in HCM 6).

Roundabout Capacity Model: US HCM 6.

HCM Delay Formula option is used. Control Delay does not include Geometric Delay since Exclude Geometric Delay option applies.

Gap-Acceptance Capacity: Traditional M1.

HV (%) values are calculated for All Movement Classes of All Heavy Vehicle Model Designation.

SimTraffic Post-Processor  
Average Results from 10 Runs  
Volume and Delay by Movement

Snow Park Village  
2040 Plus Project  
AM Peak Hour

**Intersection 1**                      **Deer Valley Drive East/Doe Pass Road**                      **Signal**

Direction	Movement	Demand Volume (vph)	Served Volume (vph)		Total Delay (sec/veh)		LOS
			Average	Percent	Average	Std. Dev.	
NB	Left Turn						
	Through	128	133	104.1%	1.2	0.6	A
	Right Turn						
	Subtotal	128	133	104.1%	1.2	0.6	A
SB	Left Turn						
	Through	208	213	102.4%	1.7	0.6	A
	Right Turn	15	14	94.7%	1.4	1.2	A
	Subtotal	223	227	101.8%	1.7	0.5	A
EB	Left Turn	31	30	97.4%	7.0	1.2	A
	Through						
	Right Turn						
	Subtotal	31	30	97.4%	7.0	1.2	A
WB	Left Turn						
	Through						
	Right Turn						
	Subtotal						
<b>Total</b>		<b>382</b>	<b>391</b>	<b>102.2%</b>	<b>1.9</b>	<b>0.6</b>	<b>A</b>

**Intersection 2**                      **Deer Valley Drive West/Doe Pass Road**                      **Side-street Stop**

Direction	Movement	Demand Volume (vph)	Served Volume (vph)		Total Delay (sec/veh)		LOS
			Average	Percent	Average	Std. Dev.	
NB	Left Turn	20	22	108.5%	9.6	3.3	A
	Through						
	Right Turn						
	Subtotal	20	22	108.5%	9.6	3.3	A
SB	Left Turn						
	Through						
	Right Turn						
	Subtotal						
EB	Left Turn						
	Through	756	754	99.7%	3.4	0.2	A
	Right Turn	20	21	103.0%	3.4	1.8	A
	Subtotal	776	775	99.8%	3.4	0.2	A
WB	Left Turn						
	Through	180	177	98.2%	1.9	0.1	A
	Right Turn						
	Subtotal	180	177	98.2%	1.9	0.1	A
<b>Total</b>		<b>976</b>	<b>973</b>	<b>99.7%</b>	<b>3.3</b>	<b>0.2</b>	<b>A</b>

SimTraffic Post-Processor  
Average Results from 10 Runs  
Volume and Delay by Movement

Snow Park Village  
2040 Plus Project  
AM Peak Hour

**Intersection 3**                      **Deer Valley Drive East/Queen Esther Drive**                      **Side-street Stop**

Direction	Movement	Demand Volume (vph)	Served Volume (vph)		Total Delay (sec/veh)		
			Average	Percent	Average	Std. Dev.	LOS
NB	Left Turn						
	Through	184	191	104.0%	0.6	0.1	A
	Right Turn	20	20	101.5%	0.4	0.5	A
	Subtotal	204	212	103.8%	0.5	0.1	A
SB	Left Turn	50	53	106.8%	4.4	0.7	A
	Through	217	224	103.0%	1.1	0.3	A
	Right Turn						
	Subtotal	267	277	103.7%	1.8	0.4	A
EB	Left Turn						
	Through						
	Right Turn						
	Subtotal						
WB	Left Turn	20	19	95.0%	6.5	1.6	A
	Through						
	Right Turn	55	58	105.6%	5.5	0.8	A
	Subtotal	75	77	102.8%	5.8	0.7	A
Total		546	566	103.6%	1.9	0.2	A

**Intersection 4**                      **Solamere Drive/Deer Valley Drive East**                      **Side-street Stop**

Direction	Movement	Demand Volume (vph)	Served Volume (vph)		Total Delay (sec/veh)		
			Average	Percent	Average	Std. Dev.	LOS
NB	Left Turn						
	Through						
	Right Turn						
	Subtotal						
SB	Left Turn	25	24	97.6%	7.8	2.8	A
	Through						
	Right Turn	60	59	98.8%	6.6	1.0	A
	Subtotal	85	84	98.5%	7.0	1.3	A
EB	Left Turn	50	47	94.8%	4.9	1.0	A
	Through	242	251	103.7%	1.7	0.3	A
	Right Turn						
	Subtotal	292	298	102.2%	2.1	0.3	A
WB	Left Turn						
	Through	219	231	105.5%	1.0	0.1	A
	Right Turn	20	18	90.5%	0.4	0.4	A
	Subtotal	239	249	104.3%	0.9	0.1	A
Total		616	631	102.5%	2.4	0.3	A



SimTraffic Post-Processor  
Average Results from 10 Runs  
Volume and Delay by Movement

Snow Park Village  
2040 Plus Project  
AM Peak Hour

**Intersection 5**                      **Deer Valley Drive West/Deer Valley Drive East**                      **Side-street Stop**

Direction	Movement	Demand Volume (vph)	Served Volume (vph)		Total Delay (sec/veh)		
			Average	Percent	Average	Std. Dev.	LOS
NB	Left Turn						
	Through	185	183	98.8%	1.3	0.3	A
	Right Turn	15	16	106.7%	1.6	1.3	A
	Subtotal	200	199	99.4%	1.3	0.3	A
SB	Left Turn	277	282	101.8%	7.7	1.4	A
	Through	766	758	98.9%	4.7	0.6	A
	Right Turn						
	Subtotal	1,043	1,040	99.7%	5.5	0.8	A
EB	Left Turn						
	Through						
	Right Turn						
	Subtotal						
WB	Left Turn	10	11	105.0%	33.3	22.6	D
	Through						
	Right Turn	269	280	104.1%	7.3	1.7	A
	Subtotal	279	291	104.1%	8.2	1.9	A
<b>Total</b>		<b>1,522</b>	<b>1,529</b>	<b>100.4%</b>	<b>5.5</b>	<b>0.6</b>	<b>A</b>

**Intersection 7**                      **Deer Valley Drive/Bonanza Drive**                      **Signal**

Direction	Movement	Demand Volume (vph)	Served Volume (vph)		Total Delay (sec/veh)		
			Average	Percent	Average	Std. Dev.	LOS
NB	Left Turn						
	Through	314	306	97.3%	21.0	10.9	C
	Right Turn	216	217	100.6%	3.3	0.7	A
	Subtotal	530	523	98.6%	13.9	7.0	B
SB	Left Turn	125	98	78.3%	12.2	1.4	B
	Through	697	587	84.2%	8.9	1.2	A
	Right Turn						
	Subtotal	822	685	83.3%	9.4	1.1	A
EB	Left Turn						
	Through						
	Right Turn						
	Subtotal						
WB	Left Turn	717	722	100.7%	22.8	8.0	C
	Through						
	Right Turn	225	222	98.8%	13.5	15.2	B
	Subtotal	942	944	100.2%	20.7	9.6	C
<b>Total</b>		<b>2,294</b>	<b>2,152</b>	<b>93.8%</b>	<b>15.4</b>	<b>5.6</b>	<b>B</b>

**Intersection 8 SR-224-Park Avenue/Empire Avenue-Deer Valley Drive Signal**

Direction	Movement	Demand Volume (vph)	Served Volume (vph)		Total Delay (sec/veh)		LOS
			Average	Percent	Average	Std. Dev.	
NB	Left Turn	95	89	93.8%	34.0	7.9	C
	Through	195	200	102.3%	49.5	5.0	D
	Right Turn	70	71	101.1%	23.4	9.3	C
	Subtotal	360	359	99.8%	40.9	5.1	D
SB	Left Turn	522	330	63.1%	81.7	10.2	F
	Through	170	108	63.6%	70.1	11.1	E
	Right Turn	1,565	1,008	64.4%	120.1	3.4	F
	Subtotal	2,257	1,445	64.0%	107.6	3.2	F
EB	Left Turn	580	535	92.3%	75.7	8.1	E
	Through	360	332	92.1%	53.2	15.6	D
	Right Turn	45	44	97.1%	48.1	17.2	D
	Subtotal	985	911	92.4%	66.1	10.3	E
WB	Left Turn	50	47	94.0%	111.8	11.8	F
	Through	425	404	95.2%	99.5	6.2	F
	Right Turn	254	230	90.4%	15.3	4.1	B
	Subtotal	729	681	93.4%	71.2	4.4	E
Total		4,331	3,396	78.4%	82.2	2.7	F

**Intersection 9 Monitor Drive-Bonanza Drive/SR-248 Signal**

Direction	Movement	Demand Volume (vph)	Served Volume (vph)		Total Delay (sec/veh)		LOS
			Average	Percent	Average	Std. Dev.	
NB	Left Turn	75	69	91.6%	31.3	7.4	C
	Through	30	27	90.3%	30.1	10.9	C
	Right Turn	136	126	92.8%	3.7	0.9	A
	Subtotal	241	222	92.1%	15.6	4.0	B
SB	Left Turn	65	64	98.8%	23.3	3.7	C
	Through	75	77	102.1%	33.5	6.5	C
	Right Turn	35	39	110.3%	5.3	1.1	A
	Subtotal	175	179	102.5%	23.9	4.0	C
EB	Left Turn	25	27	106.0%	14.7	5.8	B
	Through	340	342	100.6%	22.6	1.5	C
	Right Turn	110	107	97.5%	14.9	2.5	B
	Subtotal	475	476	100.2%	20.4	1.2	C
WB	Left Turn	362	369	102.0%	18.8	2.0	B
	Through	475	485	102.0%	9.9	0.9	A
	Right Turn	55	56	101.6%	7.3	3.1	A
	Subtotal	892	910	102.0%	13.5	1.3	B
Total		1,783	1,787	100.2%	16.6	1.4	B

# MOVEMENT SUMMARY

 Site: 101 [2040 Plus Project AM]

Deer Valley Drive / Marsac Avenue Roundabout  
 Site Category: (None)  
 Roundabout

Movement Performance - Vehicles												
Mov ID	Turn	Demand Total	Flows HV %	Deg. Satn v/c	Average Delay sec	Level of Service	95% Back of Queue Vehicles veh	Distance ft	Prop. Queued	Effective Stop Rate	Aver. No. Cycles	Average Speed mph
South: Marsac Avenue												
3	L2	5	100.0	0.245	18.2	LOS C	0.8	22.1	0.71	0.71	0.71	32.3
8	T1	133	3.0	0.245	11.2	LOS B	0.9	22.3	0.71	0.71	0.71	32.5
18b	R3	94	3.0	0.245	11.1	LOS B	0.9	22.3	0.71	0.71	0.71	31.0
Approach		232	5.2	0.245	11.3	LOS B	0.9	22.3	0.71	0.71	0.71	31.9
SouthEast: RoadName												
3bx	L3	56	3.0	0.213	5.1	LOS A	0.8	23.4	0.33	0.21	0.33	35.4
3ax	L1	26	100.0	0.213	8.0	LOS A	0.8	23.4	0.33	0.21	0.33	33.9
18ax	R1	390	3.0	0.213	5.0	LOS A	0.9	24.2	0.34	0.21	0.34	35.1
Approach		472	8.2	0.213	5.2	LOS A	0.9	24.2	0.34	0.21	0.34	35.1
North: Deer Valley Drive												
7u	U	27	3.0	0.939	31.6	LOS D	47.7	1222.0	1.00	1.00	1.71	24.8
7a	L1	1022	3.0	0.939	31.6	LOS D	47.7	1222.0	1.00	1.00	1.71	24.2
4	T1	399	3.0	0.939	12.6	LOS B	47.7	1222.0	0.48	0.39	0.68	31.5
14	R2	16	100.0	0.257	8.0	LOS A	1.1	30.6	0.28	0.15	0.28	34.1
Approach		1464	4.1	0.939	26.2	LOS D	47.7	1222.0	0.85	0.82	1.42	25.9
West: Transit Center												
5	L2	5	100.0	0.274	27.3	LOS D	0.5	21.2	0.76	0.83	0.98	26.5
12a	R1	31	100.0	0.274	27.3	LOS D	0.5	21.2	0.76	0.83	0.98	26.2
12	R2	16	100.0	0.274	27.3	LOS D	0.5	21.2	0.76	0.83	0.98	25.7
Approach		52	100.0	0.274	27.3	LOS D	0.5	21.2	0.76	0.83	0.98	26.0
All Vehicles		2220	7.3	0.939	20.2	LOS C	47.7	1222.0	0.72	0.68	1.10	28.0

Site Level of Service (LOS) Method: Delay & v/c (HCM 6). Site LOS Method is specified in the Parameter Settings dialog (Site tab).

Roundabout LOS Method: Same as Sign Control.

Vehicle movement LOS values are based on average delay and v/c ratio (degree of saturation) per movement.

LOS F will result if v/c > 1 irrespective of movement delay value (does not apply for approaches and intersection).

Intersection and Approach LOS values are based on average delay for all movements (v/c not used as specified in HCM 6).

Roundabout Capacity Model: US HCM 6.

HCM Delay Formula option is used. Control Delay does not include Geometric Delay since Exclude Geometric Delay option applies.

Gap-Acceptance Capacity: Traditional M1.

HV (%) values are calculated for All Movement Classes of All Heavy Vehicle Model Designation.

SimTraffic Post-Processor  
Average Results from 10 Runs  
Volume and Delay by Movement

Snow Park Village  
2040 Plus Project  
PM Peak Hour

**Intersection 1**                      **Deer Valley Drive East/Doe Pass Road**                      **Signal**

Direction	Movement	Demand Volume (vph)	Served Volume (vph)		Total Delay (sec/veh)		LOS
			Average	Percent	Average	Std. Dev.	
NB	Left Turn						
	Through	440	444	100.8%	2.0	2.2	A
	Right Turn						
	Subtotal	440	444	100.8%	2.0	2.2	A
SB	Left Turn						
	Through	180	178	98.8%	1.4	0.6	A
	Right Turn	15	16	104.0%	0.9	1.6	A
	Subtotal	195	193	99.2%	1.3	0.6	A
EB	Left Turn	26	26	99.6%	9.0	4.1	A
	Through						
	Right Turn						
	Subtotal	26	26	99.6%	9.0	4.1	A
WB	Left Turn						
	Through						
	Right Turn						
	Subtotal						
<b>Total</b>		<b>661</b>	<b>663</b>	<b>100.3%</b>	<b>2.1</b>	<b>1.6</b>	<b>A</b>

**Intersection 2**                      **Deer Valley Drive West/Doe Pass Road**                      **Side-street Stop**

Direction	Movement	Demand Volume (vph)	Served Volume (vph)		Total Delay (sec/veh)		LOS
			Average	Percent	Average	Std. Dev.	
NB	Left Turn	20	21	107.0%	16.3	7.1	C
	Through						
	Right Turn						
	Subtotal	20	21	107.0%	16.3	7.1	C
SB	Left Turn						
	Through						
	Right Turn						
	Subtotal						
EB	Left Turn						
	Through	264	265	100.4%	1.7	0.3	A
	Right Turn	20	18	88.5%	1.1	1.1	A
	Subtotal	284	283	99.6%	1.7	0.3	A
WB	Left Turn						
	Through	670	679	101.3%	2.6	0.1	A
	Right Turn						
	Subtotal	670	679	101.3%	2.6	0.1	A
<b>Total</b>		<b>974</b>	<b>983</b>	<b>100.9%</b>	<b>2.7</b>	<b>0.3</b>	<b>A</b>

SimTraffic Post-Processor  
Average Results from 10 Runs  
Volume and Delay by Movement

Snow Park Village  
2040 Plus Project  
PM Peak Hour

**Intersection 3**                      **Deer Valley Drive East/Queen Esther Drive**                      **Side-street Stop**

Direction	Movement	Demand Volume (vph)	Served Volume (vph)		Total Delay (sec/veh)		
			Average	Percent	Average	Std. Dev.	LOS
NB	Left Turn						
	Through	470	454	96.5%	117.8	82.3	F
	Right Turn	30	32	105.3%	116.9	92.6	F
	Subtotal	500	485	97.0%	118.4	83.1	F
SB	Left Turn	85	83	98.1%	4.6	0.7	A
	Through	215	218	101.3%	1.3	0.3	A
	Right Turn						
	Subtotal	300	301	100.4%	2.2	0.4	A
EB	Left Turn						
	Through						
	Right Turn						
	Subtotal						
WB	Left Turn	30	26	87.7%	413.9	364.1	F
	Through						
	Right Turn	60	52	87.2%	433.0	356.0	F
	Subtotal	90	79	87.3%	157.5	186.7	F
Total		890	865	97.2%	75.3	46.6	F

**Intersection 4**                      **Solamere Drive/Deer Valley Drive East**                      **Side-street Stop**

Direction	Movement	Demand Volume (vph)	Served Volume (vph)		Total Delay (sec/veh)		
			Average	Percent	Average	Std. Dev.	LOS
NB	Left Turn						
	Through						
	Right Turn						
	Subtotal						
SB	Left Turn	20	15	74.5%	396.6	289.0	F
	Through						
	Right Turn	80	55	68.9%	394.9	266.5	F
	Subtotal	100	70	70.0%	215.4	148.1	F
EB	Left Turn	90	92	102.0%	5.0	0.9	A
	Through	280	283	100.9%	2.2	0.4	A
	Right Turn						
	Subtotal	370	374	101.2%	2.9	0.3	A
WB	Left Turn						
	Through	495	451	91.1%	144.6	23.4	F
	Right Turn	35	36	101.4%	143.0	39.8	F
	Subtotal	530	486	91.7%	144.3	24.3	F
Total		1,000	931	93.1%	90.2	20.7	F

SimTraffic Post-Processor  
Average Results from 10 Runs  
Volume and Delay by Movement

Snow Park Village  
2040 Plus Project  
PM Peak Hour

**Intersection 5**                      **Deer Valley Drive West/Deer Valley Drive East**                      **Side-street Stop**

Direction	Movement	Demand Volume (vph)	Served Volume (vph)		Total Delay (sec/veh)		
			Average	Percent	Average	Std. Dev.	LOS
NB	Left Turn						
	Through	645	654	101.4%	3.0	0.3	A
	Right Turn	45	47	104.7%	2.5	1.0	A
	Subtotal	690	701	101.6%	3.0	0.3	A
SB	Left Turn	325	328	101.0%	13.3	4.7	B
	Through	259	262	101.0%	2.6	0.7	A
	Right Turn						
	Subtotal	584	590	101.0%	8.6	2.6	A
EB	Left Turn						
	Through						
	Right Turn						
	Subtotal						
WB	Left Turn	25	22	86.0%	166.7	37.2	F
	Through						
	Right Turn	550	436	79.3%	134.9	10.2	F
	Subtotal	575	458	79.6%	136.7	10.9	F
Total		1,849	1,748	94.6%	40.2	0.7	E

**Intersection 7**                      **Deer Valley Drive/Bonanza Drive**                      **Signal**

Direction	Movement	Demand Volume (vph)	Served Volume (vph)		Total Delay (sec/veh)		
			Average	Percent	Average	Std. Dev.	LOS
NB	Left Turn						
	Through	835	798	95.5%	141.2	68.0	F
	Right Turn	840	793	94.3%	174.1	91.5	F
	Subtotal	1,675	1,590	94.9%	157.4	78.4	F
SB	Left Turn	290	182	62.6%	21.2	3.7	C
	Through	522	355	68.0%	8.4	1.3	A
	Right Turn						
	Subtotal	812	536	66.1%	12.7	1.8	B
EB	Left Turn						
	Through						
	Right Turn						
	Subtotal						
WB	Left Turn	551	560	101.7%	33.6	8.1	C
	Through						
	Right Turn	150	153	102.1%	22.3	8.8	C
	Subtotal	701	713	101.8%	31.0	8.2	C
Total		3,188	2,840	89.1%	97.3	41.9	F

**Intersection 8**                      **SR-224-Park Avenue/Empire Avenue-Deer Valley Drive**                      **Signal**

Direction	Movement	Demand Volume (vph)	Served Volume (vph)		Total Delay (sec/veh)		LOS
			Average	Percent	Average	Std. Dev.	
NB	Left Turn	70	67	95.1%	41.0	8.8	D
	Through	395	394	99.7%	52.3	3.9	D
	Right Turn	70	73	104.7%	35.5	12.6	D
	Subtotal	535	534	99.7%	48.6	4.0	D
SB	Left Turn	547	362	66.2%	224.7	12.9	F
	Through	365	241	65.9%	185.1	14.0	F
	Right Turn	720	478	66.3%	59.8	9.2	E
	Subtotal	1,632	1,080	66.2%	141.8	10.7	F
EB	Left Turn	1,190	530	44.5%	86.6	4.6	F
	Through	445	201	45.2%	62.9	11.5	E
	Right Turn	70	34	49.0%	53.9	19.0	D
	Subtotal	1,705	766	44.9%	79.2	6.3	E
WB	Left Turn	75	66	88.3%	118.6	18.3	F
	Through	405	397	97.9%	94.0	6.3	F
	Right Turn	690	578	83.7%	40.9	5.2	D
	Subtotal	1,170	1,040	88.9%	66.4	2.9	E
<b>Total</b>		<b>5,042</b>	<b>3,420</b>	<b>67.8%</b>	<b>89.9</b>	<b>2.3</b>	<b>F</b>

**Intersection 9**                      **Monitor Drive-Bonanza Drive/SR-248**                      **Signal**

Direction	Movement	Demand Volume (vph)	Served Volume (vph)		Total Delay (sec/veh)		LOS
			Average	Percent	Average	Std. Dev.	
NB	Left Turn	210	188	89.4%	62.1	22.8	E
	Through	90	90	99.8%	44.4	14.3	D
	Right Turn	585	515	88.0%	22.8	10.6	C
	Subtotal	885	793	89.5%	35.3	13.9	D
SB	Left Turn	105	102	97.4%	39.6	9.8	D
	Through	55	52	93.8%	46.7	10.1	D
	Right Turn	75	74	98.0%	6.3	1.1	A
	Subtotal	235	227	96.8%	30.2	5.6	C
EB	Left Turn	85	88	103.2%	22.0	3.0	C
	Through	865	867	100.2%	42.7	5.2	D
	Right Turn	175	177	101.0%	41.1	7.7	D
	Subtotal	1,125	1,131	100.6%	40.9	5.3	D
WB	Left Turn	276	275	99.6%	24.4	4.5	C
	Through	570	564	98.9%	12.4	1.7	B
	Right Turn	55	52	95.3%	9.3	3.7	A
	Subtotal	901	891	98.9%	15.9	1.8	B
<b>Total</b>		<b>3,146</b>	<b>3,042</b>	<b>96.7%</b>	<b>31.5</b>	<b>4.1</b>	<b>C</b>

# MOVEMENT SUMMARY

 Site: 101 [2040 Plus Project PM]

Deer Valley Drive / Marsac Avenue Roundabout  
 Site Category: (None)  
 Roundabout

Movement Performance - Vehicles												
Mov ID	Turn	Demand Total	Flows HV %	Deg. Satn v/c	Average Delay sec	Level of Service	95% Back of Queue Vehicles	Distance ft	Prop. Queued	Effective Stop Rate	Aver. No. Cycles	Average Speed mph
South: Marsac Avenue												
3	L2	1	100.0	0.447	17.6	LOS C	2.3	59.9	0.71	0.81	1.01	31.4
8	T1	475	3.0	0.447	12.3	LOS B	2.3	60.0	0.71	0.81	1.01	32.2
18b	R3	96	3.0	0.447	12.3	LOS B	2.3	60.0	0.71	0.81	1.01	30.7
Approach		572	3.2	0.447	12.3	LOS B	2.3	60.0	0.71	0.81	1.01	32.0
SouthEast: RoadName												
3bx	L3	61	3.0	0.753	23.4	LOS C	7.7	202.0	0.85	1.21	1.93	28.1
3ax	L1	20	100.0	0.753	28.3	LOS D	7.7	202.0	0.85	1.21	1.93	27.0
18ax	R1	949	3.0	0.753	23.2	LOS C	7.9	203.4	0.86	1.21	1.92	27.6
Approach		1030	4.9	0.753	23.3	LOS C	7.9	203.4	0.86	1.21	1.92	27.6
North: Deer Valley Drive												
7u	U	242	3.0	0.762	15.2	LOS C	8.6	220.1	0.62	0.36	0.62	29.9
7a	L1	524	3.0	0.762	15.2	LOS C	8.6	220.1	0.62	0.36	0.62	29.0
4	T1	429	3.0	0.762	9.3	LOS A	8.6	220.1	0.41	0.23	0.41	32.7
14	R2	10	100.0	0.208	7.4	LOS A	0.9	23.8	0.25	0.13	0.25	34.4
Approach		1206	3.8	0.762	13.0	LOS B	8.6	220.1	0.54	0.31	0.54	30.5
West: Transit Center												
5	L2	5	100.0	0.128	18.1	LOS C	0.2	9.4	0.68	0.68	0.68	29.6
12a	R1	20	100.0	0.128	18.1	LOS C	0.2	9.4	0.68	0.68	0.68	29.2
12	R2	5	100.0	0.128	18.1	LOS C	0.2	9.4	0.68	0.68	0.68	28.6
Approach		30	100.0	0.128	18.1	LOS C	0.2	9.4	0.68	0.68	0.68	29.1
All Vehicles		2838	5.1	0.762	16.7	LOS C	8.6	220.1	0.69	0.74	1.14	29.6

Site Level of Service (LOS) Method: Delay & v/c (HCM 6). Site LOS Method is specified in the Parameter Settings dialog (Site tab).

Roundabout LOS Method: Same as Sign Control.

Vehicle movement LOS values are based on average delay and v/c ratio (degree of saturation) per movement.

LOS F will result if v/c > 1 irrespective of movement delay value (does not apply for approaches and intersection).

Intersection and Approach LOS values are based on average delay for all movements (v/c not used as specified in HCM 6).

Roundabout Capacity Model: US HCM 6.

HCM Delay Formula option is used. Control Delay does not include Geometric Delay since Exclude Geometric Delay option applies.

Gap-Acceptance Capacity: Traditional M1.

HV (%) values are calculated for All Movement Classes of All Heavy Vehicle Model Designation.

**SIDRA INTERSECTION 8.0 | Copyright © 2000-2019 Akcelik and Associates Pty Ltd | sidrasolutions.com**

Organisation: FEHR AND PEERS | Processed: Saturday, July 23, 2022 11:31:23 AM

Project: C:\Users\syamagata\Desktop\Projects\Snow Park Village\July 2022 TIS Update\SIDRA\DeerValleyDrRoundabout.sip8



**SimTraffic Post-Processor**  
**Average Results from 10 Runs**  
**Volume and Delay by Movement**

**Snow Park Village**  
**2040 Plus Project - Mitigated**  
**AM Peak Hour**

**Intersection 1**                      **Deer Valley Drive East/Doe Pass Road**                      **Signal**

Direction	Movement	Demand Volume (vph)	Served Volume (vph)		Total Delay (sec/veh)		
			Average	Percent	Average	Std. Dev.	LOS
NB	Left Turn	278	274	98.7%	3.1	1.6	A
	Through						
	Right Turn						
	Subtotal	278	274	98.7%	3.1	1.6	A
SB	Left Turn	348	345	99.2%	4.6	1.9	A
	Through						
	Right Turn						
	Subtotal	363	361	99.3%	4.5	1.9	A
EB	Left Turn	31	30	97.7%	11.3	5.4	B
	Through						
	Right Turn						
	Subtotal	31	30	97.7%	11.3	5.4	B
WB	Left Turn						
	Through						
	Right Turn						
	Subtotal						
<b>Total</b>		<b>672</b>	<b>665</b>	<b>99.0%</b>	<b>4.2</b>	<b>1.8</b>	<b>A</b>

**Intersection 2**                      **Deer Valley Drive West/Doe Pass Road**                      **Side-street Stop**

Direction	Movement	Demand Volume (vph)	Served Volume (vph)		Total Delay (sec/veh)		
			Average	Percent	Average	Std. Dev.	LOS
NB	Left Turn	20	22	107.5%	8.8	3.6	A
	Through						
	Right Turn						
	Subtotal	20	22	107.5%	8.8	3.6	A
SB	Left Turn						
	Through						
	Right Turn						
	Subtotal						
EB	Left Turn	616	622	100.9%	1.3	0.1	A
	Through						
	Right Turn						
	Subtotal	636	641	100.7%	1.3	0.1	A
WB	Left Turn	30	32	105.3%	1.0	0.3	A
	Through						
	Right Turn						
	Subtotal	30	32	105.3%	1.0	0.3	A
<b>Total</b>		<b>686</b>	<b>694</b>	<b>101.1%</b>	<b>1.5</b>	<b>0.2</b>	<b>A</b>

SimTraffic Post-Processor  
Average Results from 10 Runs  
Volume and Delay by Movement

Snow Park Village  
2040 Plus Project - Mitigated  
AM Peak Hour

Intersection 3                      Deer Valley Drive East/Queen Esther Drive                      Side-street Stop

Direction	Movement	Demand Volume (vph)	Served Volume (vph)		Total Delay (sec/veh)		
			Average	Percent	Average	Std. Dev.	LOS
NB	Left Turn						
	Through	334	328	98.2%	0.3	0.1	A
	Right Turn	20	23	113.5%	0.2	0.1	A
	Subtotal	354	351	99.1%	0.3	0.1	A
SB	Left Turn	50	48	95.4%	4.4	0.6	A
	Through	357	356	99.7%	0.5	0.1	A
	Right Turn						
	Subtotal	407	404	99.1%	1.0	0.2	A
EB	Left Turn						
	Through						
	Right Turn						
	Subtotal						
WB	Left Turn	20	23	113.0%	7.7	2.7	A
	Through						
	Right Turn	55	55	100.5%	6.4	0.8	A
	Subtotal	75	78	103.9%	6.8	1.1	A
Total		836	832	99.5%	1.2	0.2	A

Intersection 4                      Solamere Drive/Deer Valley Drive East                      Side-street Stop

Direction	Movement	Demand Volume (vph)	Served Volume (vph)		Total Delay (sec/veh)		
			Average	Percent	Average	Std. Dev.	LOS
NB	Left Turn						
	Through						
	Right Turn						
	Subtotal						
SB	Left Turn	25	26	104.4%	8.5	2.8	A
	Through						
	Right Turn	60	61	101.2%	7.5	1.4	A
	Subtotal	85	87	102.1%	7.9	1.7	A
EB	Left Turn	50	51	102.4%	6.7	1.2	A
	Through	382	377	98.6%	2.3	0.3	A
	Right Turn						
	Subtotal	432	428	99.1%	2.8	0.4	A
WB	Left Turn						
	Through	369	364	98.7%	0.4	0.1	A
	Right Turn	20	19	95.0%	0.2	0.3	A
	Subtotal	389	383	98.5%	0.4	0.1	A
Total		906	898	99.1%	2.2	0.3	A

**SimTraffic Post-Processor**  
**Average Results from 10 Runs**  
**Volume and Delay by Movement**

**Snow Park Village**  
**2040 Plus Project - Mitigated**  
**AM Peak Hour**

**Intersection 5**                      **Deer Valley Drive West/Deer Valley Drive East**                      **Signal**

Direction	Movement	Demand Volume (vph)	Served Volume (vph)		Total Delay (sec/veh)		LOS
			Average	Percent	Average	Std. Dev.	
NB	Left Turn						
	Through	35	37	106.0%	17.2	6.4	B
	Right Turn	15	15	98.7%	5.7	2.9	A
	Subtotal	50	52	103.8%	13.9	4.4	B
SB	Left Turn	417	412	98.9%	9.6	1.6	A
	Through	626	622	99.3%	7.3	1.8	A
	Right Turn						
	Subtotal	1,043	1,034	99.1%	8.2	1.7	A
EB	Left Turn						
	Through						
	Right Turn						
	Subtotal						
WB	Left Turn	10	12	116.0%	27.0	15.0	C
	Through						
	Right Turn	419	410	97.9%	4.7	0.9	A
	Subtotal	429	422	98.3%	5.3	0.9	A
<b>Total</b>		<b>1,522</b>	<b>1,508</b>	<b>99.1%</b>	<b>7.6</b>	<b>1.3</b>	<b>A</b>

**Intersection 7**                      **Deer Valley Drive/Bonanza Drive**                      **Signal**

Direction	Movement	Demand Volume (vph)	Served Volume (vph)		Total Delay (sec/veh)		LOS
			Average	Percent	Average	Std. Dev.	
NB	Left Turn						
	Through	314	313	99.8%	46.8	25.6	D
	Right Turn	216	218	100.9%	4.8	0.7	A
	Subtotal	530	531	100.2%	29.3	15.6	C
SB	Left Turn	125	103	82.4%	14.5	2.3	B
	Through	697	585	83.9%	9.9	1.6	A
	Right Turn						
	Subtotal	822	688	83.7%	10.6	1.4	B
EB	Left Turn						
	Through						
	Right Turn						
	Subtotal						
WB	Left Turn	717	694	96.7%	30.7	15.0	C
	Through						
	Right Turn	225	224	99.4%	30.2	27.0	C
	Subtotal	942	917	97.4%	30.8	17.4	C
<b>Total</b>		<b>2,294</b>	<b>2,136</b>	<b>93.1%</b>	<b>23.4</b>	<b>10.2</b>	<b>C</b>

SimTraffic Post-Processor  
Average Results from 10 Runs  
Volume and Delay by Movement

Snow Park Village  
2040 Plus Project - Mitigated  
AM Peak Hour

Intersection 8 SR-224-Park Avenue/Empire Avenue-Deer Valley Drive Signal

Direction	Movement	Demand Volume (vph)	Served Volume (vph)		Total Delay (sec/veh)		
			Average	Percent	Average	Std. Dev.	LOS
NB	Left Turn	95	95	99.5%	33.7	6.6	C
	Through	195	194	99.4%	52.8	6.7	D
	Right Turn	70	72	102.4%	22.8	9.2	C
	Subtotal	360	360	100.0%	41.3	4.6	D
SB	Left Turn	522	337	64.5%	86.7	19.1	F
	Through	170	112	65.8%	78.3	16.3	E
	Right Turn	1,565	1,005	64.2%	121.7	3.7	F
	Subtotal	2,257	1,453	64.4%	110.5	4.8	F
EB	Left Turn	580	531	91.5%	71.5	3.2	E
	Through	360	326	90.6%	49.3	6.9	D
	Right Turn	45	42	93.8%	43.4	12.1	D
	Subtotal	985	899	91.3%	62.1	4.3	E
WB	Left Turn	50	43	86.8%	117.8	9.9	F
	Through	425	413	97.1%	100.1	6.7	F
	Right Turn	254	227	89.4%	14.3	2.6	B
	Subtotal	729	683	93.7%	74.4	4.0	E
Total		4,331	3,396	78.4%	83.2	2.4	F

Intersection 9 Monitor Drive-Bonanza Drive/SR-248 Signal

Direction	Movement	Demand Volume (vph)	Served Volume (vph)		Total Delay (sec/veh)		
			Average	Percent	Average	Std. Dev.	LOS
NB	Left Turn	75	73	96.7%	28.5	5.3	C
	Through	30	28	92.7%	30.9	12.1	C
	Right Turn	136	125	92.0%	3.7	0.8	A
	Subtotal	241	225	93.5%	16.2	2.9	B
SB	Left Turn	65	70	107.1%	23.1	7.2	C
	Through	75	78	103.6%	30.0	5.3	C
	Right Turn	35	35	99.1%	5.1	1.6	A
	Subtotal	175	182	104.0%	22.5	4.3	C
EB	Left Turn	25	24	94.8%	14.1	3.7	B
	Through	340	336	98.7%	19.8	2.1	B
	Right Turn	110	114	103.5%	12.5	2.7	B
	Subtotal	475	473	99.6%	17.6	2.1	B
WB	Left Turn	362	357	98.5%	17.5	2.3	B
	Through	475	475	99.9%	9.5	1.1	A
	Right Turn	55	55	99.5%	7.7	2.0	A
	Subtotal	892	886	99.3%	12.6	1.0	B
Total		1,783	1,767	99.1%	15.4	1.1	B

**SimTraffic Post-Processor**  
**Average Results from 10 Runs**  
**Volume and Delay by Movement**

**Snow Park Village**  
**2040 Plus Project - Mitigated**  
**PM Peak Hour**

**Intersection 1**                      **Deer Valley Drive East/Doe Pass Road**                      **Signal**

Direction	Movement	Demand Volume (vph)	Served Volume (vph)		Total Delay (sec/veh)		
			Average	Percent	Average	Std. Dev.	LOS
NB	Left Turn	846	846	100.0%	7.0	2.8	A
	Through						
	Right Turn						
	Subtotal						
SB	Left Turn	240	237	98.7%	3.2	1.1	A
	Through						
	Right Turn						
	Subtotal						
EB	Left Turn	26	25	94.6%	22.8	9.6	C
	Through						
	Right Turn						
	Subtotal						
WB	Left Turn						
	Through						
	Right Turn						
	Subtotal						
<b>Total</b>		<b>1,127</b>	<b>1,127</b>	<b>100.0%</b>	<b>6.5</b>	<b>2.6</b>	<b>A</b>

**Intersection 2**                      **Deer Valley Drive West/Doe Pass Road**                      **Side-street Stop**

Direction	Movement	Demand Volume (vph)	Served Volume (vph)		Total Delay (sec/veh)		
			Average	Percent	Average	Std. Dev.	LOS
NB	Left Turn	20	20	98.0%	5.9	1.1	A
	Through						
	Right Turn						
	Subtotal						
SB	Left Turn						
	Through						
	Right Turn						
	Subtotal						
EB	Left Turn	204	208	102.2%	0.4	0.2	A
	Through						
	Right Turn						
	Subtotal						
WB	Left Turn	264	263	99.6%	2.0	0.1	A
	Through						
	Right Turn						
	Subtotal						
<b>Total</b>		<b>508</b>	<b>511</b>	<b>100.7%</b>	<b>1.5</b>	<b>0.2</b>	<b>A</b>

SimTraffic Post-Processor  
Average Results from 10 Runs  
Volume and Delay by Movement

Snow Park Village  
2040 Plus Project - Mitigated  
PM Peak Hour

Intersection 3                      Deer Valley Drive East/Queen Esther Drive                      Side-street Stop

Direction	Movement	Demand Volume (vph)	Served Volume (vph)		Total Delay (sec/veh)		
			Average	Percent	Average	Std. Dev.	LOS
NB	Left Turn						
	Through	876	882	100.6%	0.7	0.1	A
	Right Turn	30	30	100.0%	0.4	0.2	A
	Subtotal	906	912	100.6%	0.7	0.1	A
SB	Left Turn	85	83	98.1%	8.1	1.6	A
	Through	275	279	101.3%	0.4	0.1	A
	Right Turn						
	Subtotal	360	362	100.6%	2.1	0.2	A
EB	Left Turn						
	Through						
	Right Turn						
	Subtotal						
WB	Left Turn	30	31	104.7%	20.0	9.0	C
	Through						
	Right Turn	60	61	101.0%	17.4	5.7	C
	Subtotal	90	92	102.2%	18.2	6.5	C
Total		1,356	1,366	100.7%	2.2	0.5	A

Intersection 4                      Solamere Drive/Deer Valley Drive East                      Side-street Stop

Direction	Movement	Demand Volume (vph)	Served Volume (vph)		Total Delay (sec/veh)		
			Average	Percent	Average	Std. Dev.	LOS
NB	Left Turn						
	Through						
	Right Turn						
	Subtotal						
SB	Left Turn	20	20	99.5%	32.0	18.2	D
	Through						
	Right Turn	80	79	99.1%	25.9	8.7	D
	Subtotal	100	99	99.2%	28.0	10.0	D
EB	Left Turn	90	89	98.4%	14.2	2.6	B
	Through	340	337	99.1%	1.9	0.4	A
	Right Turn						
	Subtotal	430	426	99.0%	4.4	0.9	A
WB	Left Turn						
	Through	901	905	100.4%	1.2	0.1	A
	Right Turn	35	33	93.7%	0.8	0.2	A
	Subtotal	936	937	100.1%	1.2	0.1	A
Total		1,466	1,462	99.7%	4.2	1.0	A

**SimTraffic Post-Processor**  
**Average Results from 10 Runs**  
**Volume and Delay by Movement**

**Snow Park Village**  
**2040 Plus Project - Mitigated**  
**PM Peak Hour**

**Intersection 5**                      **Deer Valley Drive West/Deer Valley Drive East**                      **Signal**

Direction	Movement	Demand Volume (vph)	Served Volume (vph)		Total Delay (sec/veh)		
			Average	Percent	Average	Std. Dev.	LOS
NB	Left Turn						
	Through	239	241	100.9%	45.4	4.8	D
	Right Turn	45	45	99.3%	35.6	7.6	D
	Subtotal	284	286	100.7%	43.9	4.9	D
SB	Left Turn	385	378	98.1%	9.5	2.0	A
	Through	199	203	101.9%	3.1	0.7	A
	Right Turn						
	Subtotal	584	581	99.4%	7.2	1.5	A
EB	Left Turn						
	Through						
	Right Turn						
	Subtotal						
WB	Left Turn	25	25	100.0%	70.6	18.8	E
	Through						
	Right Turn	956	954	99.8%	31.2	11.1	C
	Subtotal	981	979	99.8%	32.3	11.1	C
<b>Total</b>		<b>1,849</b>	<b>1,846</b>	<b>99.8%</b>	<b>26.5</b>	<b>6.6</b>	<b>C</b>

**Intersection 7**                      **Deer Valley Drive/Bonanza Drive**                      **Signal**

Direction	Movement	Demand Volume (vph)	Served Volume (vph)		Total Delay (sec/veh)		
			Average	Percent	Average	Std. Dev.	LOS
NB	Left Turn						
	Through	835	809	96.8%	86.8	38.1	F
	Right Turn	840	817	97.2%	113.0	71.0	F
	Subtotal	1,675	1,625	97.0%	100.6	55.2	F
SB	Left Turn	290	181	62.5%	20.6	3.9	C
	Through	522	348	66.7%	8.8	1.9	A
	Right Turn						
	Subtotal	812	530	65.2%	12.7	2.1	B
EB	Left Turn						
	Through						
	Right Turn						
	Subtotal						
WB	Left Turn	551	540	98.0%	32.3	8.0	C
	Through						
	Right Turn	150	153	102.0%	17.7	5.9	B
	Subtotal	701	693	98.8%	29.0	7.1	C
<b>Total</b>		<b>3,188</b>	<b>2,848</b>	<b>89.3%</b>	<b>66.8</b>	<b>31.8</b>	<b>E</b>

SimTraffic Post-Processor  
Average Results from 10 Runs  
Volume and Delay by Movement

Snow Park Village  
2040 Plus Project - Mitigated  
PM Peak Hour

Intersection 8 SR-224-Park Avenue/Empire Avenue-Deer Valley Drive Signal

Direction	Movement	Demand Volume (vph)	Served Volume (vph)		Total Delay (sec/veh)		
			Average	Percent	Average	Std. Dev.	LOS
NB	Left Turn	70	71	100.7%	38.1	10.0	D
	Through	395	399	101.0%	55.8	3.7	E
	Right Turn	70	69	98.7%	35.9	10.6	D
	Subtotal	535	539	100.7%	51.6	4.3	D
SB	Left Turn	547	356	65.1%	224.7	17.1	F
	Through	365	247	67.5%	179.3	6.9	F
	Right Turn	720	496	68.9%	55.9	6.8	E
	Subtotal	1,632	1,099	67.4%	142.3	12.1	F
EB	Left Turn	1,190	533	44.8%	90.0	8.8	F
	Through	445	200	45.0%	75.6	24.7	E
	Right Turn	70	30	43.4%	69.9	33.2	E
	Subtotal	1,705	764	44.8%	85.5	13.2	F
WB	Left Turn	75	61	81.1%	108.1	25.8	F
	Through	405	390	96.3%	87.0	8.4	F
	Right Turn	690	601	87.0%	42.3	6.2	D
	Subtotal	1,170	1,051	89.9%	62.0	5.7	E
Total		5,042	3,453	68.5%	90.6	4.0	F

Intersection 9 Monitor Drive-Bonanza Drive/SR-248 Signal

Direction	Movement	Demand Volume (vph)	Served Volume (vph)		Total Delay (sec/veh)		
			Average	Percent	Average	Std. Dev.	LOS
NB	Left Turn	210	186	88.6%	75.2	42.0	E
	Through	90	87	97.0%	52.4	22.8	D
	Right Turn	585	523	89.3%	25.1	12.1	C
	Subtotal	885	796	89.9%	40.0	19.4	D
SB	Left Turn	105	103	98.4%	37.2	7.9	D
	Through	55	55	100.0%	46.3	12.9	D
	Right Turn	75	80	106.4%	6.7	0.7	A
	Subtotal	235	238	101.3%	30.1	7.0	C
EB	Left Turn	85	83	97.4%	19.2	11.0	B
	Through	865	849	98.1%	38.5	14.1	D
	Right Turn	175	182	104.2%	37.1	15.1	D
	Subtotal	1,125	1,114	99.0%	36.9	13.8	D
WB	Left Turn	276	270	98.0%	24.0	2.5	C
	Through	570	572	100.4%	12.0	2.0	B
	Right Turn	55	55	100.7%	9.6	2.9	A
	Subtotal	901	898	99.7%	15.5	1.2	B
Total		3,146	3,046	96.8%	30.8	9.0	C



Vissim Post-Processor  
Average Results from 10 Runs  
Volume and Delay by Movement

Snow Park Village  
2040 Plus Project - Bus Option  
AM Peak Hour

Intersection 1                      P2 Parking/Doe Pass Road                      Side-street Stop

Direction	Movement	Demand Volume (vph)	Served Volume (vph)		Total Delay (sec/veh)		
			Average	Percent	Average	Std. Dev.	LOS
NB	Left Turn	15	13	87.3%	9.8	1.1	A
	Through						
	Right Turn						
	Subtotal	15	13	87.3%	9.8	1.1	A
SB	Left Turn						
	Through						
	Right Turn						
	Subtotal						
EB	Left Turn						
	Through	40	42	104.8%	0.1	0.1	A
	Right Turn	576	559	97.0%	16.2	4.4	C
	Subtotal	616	601	97.5%	15.1	4.2	C
WB	Left Turn						
	Through	15	14	93.3%	0.0	0.0	A
	Right Turn						
	Subtotal	15	14	93.3%	0.0	0.0	A
Total		646	628	97.2%	14.7	4.1	B

Intersection 2                      P1 Parking/Doe Pass Road                      Side-street Stop

Direction	Movement	Demand Volume (vph)	Served Volume (vph)		Total Delay (sec/veh)		
			Average	Percent	Average	Std. Dev.	LOS
NB	Left Turn						
	Through						
	Right Turn	16	15	93.1%	6.7	0.1	A
	Subtotal	16	15	93.1%	6.7	0.1	A
SB	Left Turn						
	Through						
	Right Turn						
	Subtotal						
EB	Left Turn						
	Through	15	15	101.3%	0.8	0.5	A
	Right Turn	25	27	106.8%	0.5	0.1	A
	Subtotal	40	42	104.8%	0.6	0.1	A
WB	Left Turn						
	Through	15	14	93.3%	0.1	0.0	A
	Right Turn						
	Subtotal	15	14	93.3%	0.1	0.0	A
Total		71	71	99.7%	2.1	0.1	A

Vissim Post-Processor  
Average Results from 10 Runs  
Volume and Delay by Movement

Snow Park Village  
2040 Plus Project - Bus Option  
AM Peak Hour

**Intersection 3**                      **Mobility Hub Entrance/Doe Pass Road**                      **Side-street Stop**

Direction	Movement	Demand Volume (vph)	Served Volume (vph)		Total Delay (sec/veh)		
			Average	Percent	Average	Std. Dev.	LOS
NB	Left Turn						
	Through						
	Right Turn						
	Subtotal						
SB	Left Turn						
	Through						
	Right Turn						
	Subtotal						
EB	Left Turn						
	Through	16	15	93.1%	0.0	0.0	A
	Right Turn	15	15	101.3%	0.4	0.1	A
	Subtotal	31	30	97.1%	0.2	0.0	A
WB	Left Turn	15	15	100.0%	0.0	0.0	A
	Through	15	14	93.3%	0.6	0.1	A
	Right Turn						
	Subtotal	30	29	96.7%	0.3	0.0	A
Total		61	59	96.9%	0.2	0.0	A

**Intersection 4**                      **Mobility Hub Exit/Doe Pass Road**                      **Side-street Stop**

Direction	Movement	Demand Volume (vph)	Served Volume (vph)		Total Delay (sec/veh)		
			Average	Percent	Average	Std. Dev.	LOS
NB	Left Turn	15	14	93.3%	11.4	0.9	B
	Through						
	Right Turn	15	15	100.0%	9.3	0.6	A
	Subtotal	30	29	96.7%	10.5	0.6	B
SB	Left Turn						
	Through						
	Right Turn						
	Subtotal						
EB	Left Turn						
	Through	16	15	93.1%	0.3	0.2	A
	Right Turn						
	Subtotal	16	15	93.1%	0.3	0.2	A
WB	Left Turn						
	Through	15	15	100.0%	0.6	0.0	A
	Right Turn						
	Subtotal	15	15	100.0%	0.6	0.0	A
Total		61	59	96.6%	5.6	0.3	A

Vissim Post-Processor  
Average Results from 10 Runs  
Volume and Delay by Movement

Snow Park Village  
2040 Plus Project - Bus Option  
AM Peak Hour

Intersection 5                      Deer Valley Drive East/P2 Parking                      Side-street Stop

Direction	Movement	Demand Volume (vph)	Served Volume (vph)		Total Delay (sec/veh)		
			Average	Percent	Average	Std. Dev.	LOS
NB	Left Turn						
	Through	242	237	98.1%	0.7	0.2	A
	Right Turn						
	Subtotal	242	237	98.1%	0.7	0.2	A
SB	Left Turn						
	Through	303	334	110.1%	1.6	0.3	A
	Right Turn	145	47	32.1%	0.7	0.2	A
	Subtotal	448	380	84.9%	1.5	0.2	A
EB	Left Turn	36	34	93.3%	8.2	3.4	A
	Through						
	Right Turn						
	Subtotal	36	34	93.3%	8.2	3.4	A
WB	Left Turn						
	Through						
	Right Turn						
	Subtotal						
Total		726	651	89.7%	1.6	0.2	A

Intersection 6                      Deer Valley Drive East/P3 Parking                      Side-street Stop

Direction	Movement	Demand Volume (vph)	Served Volume (vph)		Total Delay (sec/veh)		
			Average	Percent	Average	Std. Dev.	LOS
NB	Left Turn						
	Through	207	204	98.4%	2.7	0.6	A
	Right Turn						
	Subtotal	207	204	98.4%	2.7	0.6	A
SB	Left Turn						
	Through	243	239	98.5%	3.7	1.6	A
	Right Turn	100	94	93.8%	2.5	1.3	A
	Subtotal	343	333	97.1%	3.4	1.4	A
EB	Left Turn	35	34	96.6%	9.6	1.3	A
	Through						
	Right Turn						
	Subtotal	35	34	96.6%	9.6	1.3	A
WB	Left Turn						
	Through						
	Right Turn						
	Subtotal						
Total		585	571	97.5%	3.6	0.7	A

Vissim Post-Processor  
Average Results from 10 Runs  
Volume and Delay by Movement

Snow Park Village  
2040 Plus Project - Bus Option  
AM Peak Hour

Intersection 7                      Deer Valley Drive East/P4 Parking                      Side-street Stop

Direction	Movement	Demand Volume (vph)	Served Volume (vph)		Total Delay (sec/veh)		
			Average	Percent	Average	Std. Dev.	LOS
NB	Left Turn	50	45	89.0%	1.6	1.3	A
	Through	150	148	98.8%	2.7	0.9	A
	Right Turn						
	Subtotal	200	193	96.4%	2.5	0.7	A
SB	Left Turn						
	Through	200	194	97.0%	8.4	10.9	A
	Right Turn	43	45	104.9%	1.8	1.0	A
	Subtotal	243	239	98.4%	7.3	9.2	A
EB	Left Turn	57	55	97.0%	17.4	1.9	C
	Through						
	Right Turn						
	Subtotal	57	55	97.0%	17.4	1.9	C
WB	Left Turn						
	Through						
	Right Turn						
	Subtotal						
Total		500	487	97.4%	6.3	4.5	A

Intersection 8                      Deer Valley Drive East/Pick-up/Drop-off                      Uncontrolled

Direction	Movement	Demand Volume (vph)	Served Volume (vph)		Total Delay (sec/veh)		
			Average	Percent	Average	Std. Dev.	LOS
NB	Left Turn						
	Through	200	193	96.5%	0.6	0.3	A
	Right Turn						
	Subtotal	200	193	96.5%	0.6	0.3	A
SB	Left Turn						
	Through	200	194	96.9%	13.4	9.6	B
	Right Turn						
	Subtotal	200	194	96.9%	13.4	9.6	B
EB	Left Turn						
	Through						
	Right Turn						
	Subtotal						
WB	Left Turn						
	Through						
	Right Turn						
	Subtotal						
Total		400	387	96.7%	7.1	5.0	A

Vissim Post-Processor  
Average Results from 10 Runs  
Queue Length

Snow Park Village  
2040 Plus Project - Bus Option  
AM Peak Hour

Intersection 101

Deer Valley Drive West/Deer Valley Drive East

Signal

Direction	Movement	Storage (ft)	Average Queue (ft)				Maximum Queue (ft)				Exceeds Storage?
			Average	Std. Dev.	Minimum	Maximum	Average	Std. Dev.	Minimum	Maximum	
NB	U Turn										
	Second Left										
	Left Turn										
	Through	500	15	2	12	17	85	12	70	99	NO
	Right Turn	500	15	2	12	17	85	12	70	99	NO
SB	Second Right										
	U Turn										
	Second Left										
	Left Turn	100	9	1	8	12	169	29	128	212	MAX
	Through	500	16	4	12	22	259	81	187	425	NO
EB	Right Turn										
	Second Right										
	U Turn										
	Second Left										
	Left Turn										
WB	Through										
	Right Turn										
	Second Right										
	U Turn										
	Second Left	500	2	1	0	4	23	11	7	38	NO
WB	Through										
	Right Turn	100	7	2	5	10	167	38	114	236	MAX
WB	Second Right										
	Second Right										

Vissim Post-Processor  
 Average Results from 10 Runs  
 Queue Length

Snow Park Village  
 2040 Plus Project - Bus Option  
 AM Peak Hour

Intersection 102      Deer Valley Drive West/Doe Pass Road      Side-street Stop

Direction	Movement	Storage (ft)	Average Queue (ft)				Maximum Queue (ft)				Exceeds Storage?
			Average	Std. Dev.	Minimum	Maximum	Average	Std. Dev.	Minimum	Maximum	
NB	U Turn	500	1	0	1	1	30	2	28	33	NO
	Second Left										
	Left Turn										
	Through										
	Right Turn										
Second Right											
SB	U Turn										
	Second Left										
	Left Turn										
	Through										
	Right Turn										
Second Right											
EB	U Turn	500	42	54	4	169	223	125	69	471	NO
	Second Left										
	Left Turn										
	Through										
	Right Turn										
Second Right											
WB	U Turn	100	0	0	0	0	0	0	0	0	NO
	Second Left										
	Left Turn										
	Through										
	Right Turn										
Second Right											

Vissim Post-Processor  
Average Results from 10 Runs  
Queue Length

Snow Park Village  
2040 Plus Project - Bus Option  
AM Peak Hour

Intersection 103

Deer Valley Drive East/Doe Pass Road

Signal

Direction	Movement	Storage (ft)	Average Queue (ft)				Maximum Queue (ft)				Exceeds Storage?
			Average	Std. Dev.	Minimum	Maximum	Average	Std. Dev.	Minimum	Maximum	
NB	U Turn	300	16	3	12	20	162	17	127	186	NO
	Second Left										
	Left Turn										
	Through										
	Right Turn										
Second Right											
SB	U Turn	150	29	4	23	34	236	18	216	265	MAX
	Second Left										
	Left Turn										
	Through										
	Right Turn										
Second Right											
EB	U Turn	75	2	0	1	2	49	14	31	72	NO
	Second Left										
	Left Turn										
	Through										
	Right Turn										
Second Right											
WB	U Turn										
	Second Left										
	Left Turn										
	Through										
	Right Turn										
Second Right											

Vissim Post-Processor  
Average Results from 10 Runs  
Queue Length

Snow Park Village  
2040 Plus Project - Bus Option  
AM Peak Hour

Intersection 104

Solamere Drive/Deer Valley Drive East

Side-street Stop

Direction	Movement	Storage (ft)	Average Queue (ft)				Maximum Queue (ft)				Exceeds Storage?
			Average	Std. Dev.	Minimum	Maximum	Average	Std. Dev.	Minimum	Maximum	
NB	U Turn										
	Second Left										
	Left Turn										
	Through										
SB	Right Turn										
	Second Right										
	U Turn										
	Second Left										
EB	Left Turn	500	4	0	3	4	63	7	56	79	NO
	Through	500	4	0	4	4	63	7	56	79	NO
	Right Turn										
	Second Right										
WB	U Turn										
	Second Left										
	Left Turn	500	1	0	0	1	32	7	20	43	NO
	Through	500	0	0	0	0	2	5	0	15	NO
WB	Right Turn										
	Second Right										
	U Turn										
	Second Left										
WB	Left Turn	500	0	0	0	0	0	0	0	0	NO
	Through	500	0	0	0	0	0	0	0	0	NO
	Right Turn										
	Second Right										



Vissim Post-Processor  
Average Results from 10 Runs  
Queue Length

Snow Park Village  
2040 Plus Project - Bus Option  
AM Peak Hour

Intersection 105

Deer Valley Drive East/Queen Esther Drive

Side-street Stop

Direction	Movement	Storage (ft)	Average Queue (ft)				Maximum Queue (ft)				Exceeds Storage?
			Average	Std. Dev.	Minimum	Maximum	Average	Std. Dev.	Minimum	Maximum	
NB	U Turn										
	Second Left										
	Left Turn										
	Through	500	0	0	0	0	0	0	0	0	NO
	Right Turn	500	0	0	0	0	0	0	0	0	NO
SB	Second Right										
	U Turn										
	Second Left										
	Left Turn	500	0	0	0	1	29	7	22	43	NO
	Through	500	2	1	1	3	33	13	17	62	NO
EB	Right Turn										
	Second Right										
	U Turn										
	Second Left										
	Left Turn										
WB	Through										
	Right Turn										
	Second Right										
	U Turn										
	Second Left	500	3	0	3	3	60	4	54	66	NO
WB	Through	500	3	0	3	4	61	4	56	67	NO

Vissim Post-Processor  
Average Results from 10 Runs  
Queue Length

Snow Park Village  
2040 Plus Project - Bus Option  
AM Peak Hour

Intersection 1

P2 Parking/Doe Pass Road

Side-street Stop

Direction	Movement	Storage (ft)	Average Queue (ft)				Maximum Queue (ft)				Exceeds Storage?
			Average	Std. Dev.	Minimum	Maximum	Average	Std. Dev.	Minimum	Maximum	
NB	U Turn	150	1	0	0	1	46	11	34	58	NO
	Second Left										
	Left Turn										
	Through										
	Right Turn										
Second Right											
SB	U Turn										
	Second Left										
	Left Turn										
	Through										
	Right Turn										
Second Right											
EB	U Turn	125	63	24	35	104	221	19	173	237	MAX
	Second Left										
	Left Turn										
	Through										
	Right Turn										
Second Right											
WB	U Turn	75	0	0	0	0	0	0	0	0	NO
	Second Left										
	Left Turn										
	Through										
	Right Turn										
Second Right											

Vissim Post-Processor  
Average Results from 10 Runs  
Queue Length

Snow Park Village  
2040 Plus Project - Bus Option  
AM Peak Hour

Intersection 2

P1 Parking/Doe Pass Road

Side-street Stop

Direction	Movement	Storage (ft)	Average Queue (ft)				Maximum Queue (ft)				Exceeds Storage?
			Average	Std. Dev.	Minimum	Maximum	Average	Std. Dev.	Minimum	Maximum	
NB	U Turn	150	3	0	3	3	57	2	56	62	NO
	Second Left										
	Left Turn										
	Through										
	Right Turn										
Second Right											
SB	U Turn										
	Second Left										
	Left Turn										
	Through										
	Right Turn										
Second Right											
EB	U Turn	125	0	0	0	0	0	0	0	0	NO
	Second Left										
	Left Turn										
	Through										
	Right Turn										
Second Right											
WB	U Turn	75	0	0	0	0	0	0	0	0	NO
	Second Left										
	Left Turn										
	Through										
	Right Turn										
Second Right											

Vissim Post-Processor  
Average Results from 10 Runs  
Queue Length

Snow Park Village  
2040 Plus Project - Bus Option  
AM Peak Hour

Intersection 3

Mobility Hub Entrance/Doe Pass Road

Side-street Stop

Direction	Movement	Storage (ft)	Average Queue (ft)				Maximum Queue (ft)				Exceeds Storage?
			Average	Std. Dev.	Minimum	Maximum	Average	Std. Dev.	Minimum	Maximum	
NB	U Turn										
	Second Left										
	Left Turn										
	Through										
	Right Turn										
SB	Second Right										
	U Turn										
	Second Left										
	Left Turn										
	Through										
EB	Right Turn										
	Second Right										
	U Turn										
	Second Left										
	Left Turn										
EB	Through	75	0	0	0	0	0	0	0	NO	
	Right Turn	75	0	0	0	0	0	0	0	NO	
WB	Second Right										
	U Turn										
	Second Left										
	Left Turn	100	1	0	1	1	105	0	105	106	MAX
	Through	100	1	0	1	1	105	0	105	106	MAX

Vissim Post-Processor  
 Average Results from 10 Runs  
 Queue Length

Snow Park Village  
 2040 Plus Project - Bus Option  
 AM Peak Hour

Intersection 4                      Mobility Hub Exit/Doe Pass Road                      Side-street Stop

Direction	Movement	Storage (ft)	Average Queue (ft)				Maximum Queue (ft)				Exceeds Storage?
			Average	Std. Dev.	Minimum	Maximum	Average	Std. Dev.	Minimum	Maximum	
NB	U Turn	100	27	6	18	39	152	22	124	183	MAX
	Second Left										
	Left Turn										
	Through										
	Right Turn	100	26	4	17	32	161	18	139	184	MAX
	Second Right										
SB	U Turn										
	Second Left										
	Left Turn										
	Through										
	Right Turn										
	Second Right										
EB	U Turn	100	0	0	0	0	0	0	0	0	0
	Second Left										
	Left Turn										
	Through										
	Right Turn										NO
	Second Right										
WB	U Turn	75	0	0	0	0	2	5	0	15	NO
	Second Left										
	Left Turn										
	Through										
	Right Turn										
	Second Right										

Vissim Post-Processor  
Average Results from 10 Runs  
Queue Length

Snow Park Village  
2040 Plus Project - Bus Option  
AM Peak Hour

Intersection 5

Deer Valley Drive East/P2 Parking

Side-street Stop

Direction	Movement	Storage (ft)	Average Queue (ft)				Maximum Queue (ft)				Exceeds Storage?
			Average	Std. Dev.	Minimum	Maximum	Average	Std. Dev.	Minimum	Maximum	
NB	U Turn	160	0	0	0	0	0	0	0	0	NO
	Second Left										
	Left Turn										
	Through										
	Right Turn										
Second Right											
SB	U Turn	300	0	0	0	0	0	0	0	0	NO
	Second Left										
	Left Turn										
	Through										
	Right Turn										
Second Right											
EB	U Turn	150	5	0	4	6	111	9	91	120	NO
	Second Left										
	Left Turn										
	Through										
	Right Turn										
Second Right											
WB	U Turn										
	Second Left										
	Left Turn										
	Through										
	Right Turn										
Second Right											

Vissim Post-Processor  
Average Results from 10 Runs  
Queue Length

Snow Park Village  
2040 Plus Project - Bus Option  
AM Peak Hour

Intersection 6

Deer Valley Drive East/P3 Parking

Side-street Stop

Direction	Movement	Storage (ft)	Average Queue (ft)				Maximum Queue (ft)				Exceeds Storage?
			Average	Std. Dev.	Minimum	Maximum	Average	Std. Dev.	Minimum	Maximum	
NB	U Turn	200	3	1	2	4	83	20	59	120	NO
	Second Left										
	Left Turn										
	Through										
	Right Turn										
Second Right											
SB	U Turn	160	4	2	1	7	122	56	46	213	NO
	Second Left										
	Left Turn										
	Through										
	Right Turn										
Second Right											
EB	U Turn	150	4	1	3	5	96	6	81	103	NO
	Second Left										
	Left Turn										
	Through										
	Right Turn										
Second Right											
WB	U Turn										
	Second Left										
	Left Turn										
	Through										
	Right Turn										
Second Right											

Vissim Post-Processor  
 Average Results from 10 Runs  
 Queue Length

Snow Park Village  
 2040 Plus Project - Bus Option  
 AM Peak Hour

Intersection 7

Deer Valley Drive East/P4 Parking

Side-street Stop

Direction	Movement	Storage (ft)	Average Queue (ft)				Maximum Queue (ft)				Exceeds Storage?
			Average	Std. Dev.	Minimum	Maximum	Average	Std. Dev.	Minimum	Maximum	
NB	U Turn										
	Second Left										
	Left Turn	100	0	0	0	0	14	14	6	51	NO
	Through	100	0	0	0	0	0	0	0	0	NO
	Right Turn										
SB	Second Right										
	U Turn										
	Second Left										
	Left Turn										
	Through	75	1	1	0	4	8	15	0	38	NO
EB	Right Turn	75	1	1	0	4	8	15	0	38	NO
	Second Right										
	U Turn										
	Second Left										
	Left Turn	150	2	1	1	4	91	13	81	110	NO
WB	Through										
	Right Turn										
	Second Right										
	U Turn										
	Second Left										



Vissim Post-Processor  
Average Results from 10 Runs  
Queue Length

Snow Park Village  
2040 Plus Project - Bus Option  
AM Peak Hour

Intersection 8                      Deer Valley Drive East/Pick-up/Drop-off                      Uncontrolled

Direction	Movement	Storage (ft)	Average Queue (ft)				Maximum Queue (ft)				Exceeds Storage?
			Average	Std. Dev.	Minimum	Maximum	Average	Std. Dev.	Minimum	Maximum	
NB	U Turn	150	0	0	0	1	20	18	0	48	NO
	Second Left										
	Left Turn										
	Through										
	Right Turn										
Second Right											
SB	U Turn	150	13	11	4	39	117	60	33	214	NO
	Second Left										
	Left Turn										
	Through										
	Right Turn										
Second Right											
EB	U Turn										
	Second Left										
	Left Turn										
	Through										
	Right Turn										
Second Right											
WB	U Turn										
	Second Left										
	Left Turn										
	Through										
	Right Turn										
Second Right											

Vissim Post-Processor  
 Average Results from 10 Runs  
 Queue Length

Snow Park Village  
 2040 Plus Project - Bus Option  
 AM Peak Hour

Intersection 0

//

Signal

Direction	Movement	Storage (ft)	Average Queue (ft)				Maximum Queue (ft)				Exceeds Storage?
			Average	Std. Dev.	Minimum	Maximum	Average	Std. Dev.	Minimum	Maximum	
NB	U Turn										
	Second Left										
	Left Turn										
	Through										
	Right Turn										
SB	Second Right										
	U Turn										
	Second Left										
	Left Turn										
	Through										
SE	Right Turn										
	Second Right										
	U Turn										
	Second Left										
	Left Turn										
EB	Through										
	Right Turn										
	Second Right										
	U Turn										
	Second Left										
WB	Left Turn										
	Through										
	Right Turn										
	Second Right										
	U Turn										

Vissim Post-Processor  
Average Results from 10 Runs  
Volume and Delay by Movement

Snow Park Village  
2040 Plus Project - Bus Option  
PM Peak Hour

Intersection 1                      P2 Parking/Doe Pass Road                      Side-street Stop

Direction	Movement	Demand Volume (vph)	Served Volume (vph)		Total Delay (sec/veh)		
			Average	Percent	Average	Std. Dev.	LOS
NB	Left Turn	249	226	90.7%	9.6	0.3	A
	Through						
	Right Turn						
	Subtotal	249	226	90.7%	9.6	0.3	A
SB	Left Turn						
	Through						
	Right Turn						
	Subtotal						
EB	Left Turn						
	Through	27	26	95.6%	0.1	0.0	A
	Right Turn	177	180	101.5%	0.8	0.2	A
	Subtotal	204	205	100.7%	0.7	0.2	A
WB	Left Turn						
	Through	15	14	94.0%	0.2	0.2	A
	Right Turn						
	Subtotal	15	14	94.0%	0.2	0.2	A
Total		468	445	95.2%	5.1	0.2	A

Intersection 2                      P1 Parking/Doe Pass Road                      Side-street Stop

Direction	Movement	Demand Volume (vph)	Served Volume (vph)		Total Delay (sec/veh)		
			Average	Percent	Average	Std. Dev.	LOS
NB	Left Turn						
	Through						
	Right Turn	11	10	90.0%	6.7	0.3	A
	Subtotal	11	10	90.0%	6.7	0.3	A
SB	Left Turn						
	Through						
	Right Turn						
	Subtotal						
EB	Left Turn						
	Through	15	15	100.0%	0.6	0.1	A
	Right Turn	12	11	89.2%	0.3	0.1	A
	Subtotal	27	26	95.2%	0.5	0.0	A
WB	Left Turn						
	Through	15	14	94.7%	0.1	0.1	A
	Right Turn						
	Subtotal	15	14	94.7%	0.1	0.1	A
Total		53	50	94.0%	1.5	0.2	A

Vissim Post-Processor  
Average Results from 10 Runs  
Volume and Delay by Movement

Snow Park Village  
2040 Plus Project - Bus Option  
PM Peak Hour

Intersection 3                      Mobility Hub Entrance/Doe Pass Road                      Side-street Stop

Direction	Movement	Demand Volume (vph)	Served Volume (vph)		Total Delay (sec/veh)		
			Average	Percent	Average	Std. Dev.	LOS
NB	Left Turn						
	Through						
	Right Turn						
	Subtotal						
SB	Left Turn						
	Through						
	Right Turn						
	Subtotal						
EB	Left Turn						
	Through	11	10	90.0%	0.0	0.1	A
	Right Turn	15	15	98.7%	0.4	0.1	A
	Subtotal	26	25	95.0%	0.2	0.1	A
WB	Left Turn	15	15	100.0%	0.1	0.0	A
	Through	15	14	94.7%	0.6	0.1	A
	Right Turn						
	Subtotal	30	29	97.3%	0.3	0.0	A
Total		56	54	96.3%	0.3	0.0	A

Intersection 4                      Mobility Hub Exit/Doe Pass Road                      Side-street Stop

Direction	Movement	Demand Volume (vph)	Served Volume (vph)		Total Delay (sec/veh)		
			Average	Percent	Average	Std. Dev.	LOS
NB	Left Turn	15	14	94.7%	11.8	0.9	B
	Through						
	Right Turn	15	15	100.0%	9.3	0.6	A
	Subtotal	30	29	97.3%	10.7	0.6	B
SB	Left Turn						
	Through						
	Right Turn						
	Subtotal						
EB	Left Turn						
	Through	11	10	90.0%	0.2	0.1	A
	Right Turn						
	Subtotal	11	10	90.0%	0.2	0.1	A
WB	Left Turn						
	Through	15	15	100.0%	0.8	0.4	A
	Right Turn						
	Subtotal	15	15	100.0%	0.8	0.4	A
Total		56	54	96.6%	6.2	0.4	A

Vissim Post-Processor  
Average Results from 10 Runs  
Volume and Delay by Movement

Snow Park Village  
2040 Plus Project - Bus Option  
PM Peak Hour

Intersection 5                      Deer Valley Drive East/P2 Parking                      Side-street Stop

Direction	Movement	Demand Volume (vph)	Served Volume (vph)		Total Delay (sec/veh)		
			Average	Percent	Average	Std. Dev.	LOS
NB	Left Turn						
	Through	579	571	98.5%	8.3	3.8	A
	Right Turn						
	Subtotal	579	571	98.5%	8.3	3.8	A
SB	Left Turn						
	Through	190	189	99.6%	1.7	0.2	A
	Right Turn						
	Subtotal	240	237	98.9%	1.5	0.2	A
EB	Left Turn	267	265	99.2%	12.2	2.4	B
	Through						
	Right Turn						
	Subtotal	267	265	99.2%	12.2	2.4	B
WB	Left Turn						
	Through						
	Right Turn						
	Subtotal						
Total		1,086	1,073	98.8%	7.9	2.5	A

Intersection 6                      Deer Valley Drive East/P3 Parking                      Side-street Stop

Direction	Movement	Demand Volume (vph)	Served Volume (vph)		Total Delay (sec/veh)		
			Average	Percent	Average	Std. Dev.	LOS
NB	Left Turn						
	Through	318	312	98.1%	4.4	3.5	A
	Right Turn						
	Subtotal	318	312	98.1%	4.4	3.5	A
SB	Left Turn						
	Through	190	189	99.5%	3.5	2.0	A
	Right Turn						
	Subtotal	190	189	99.5%	3.5	2.0	A
EB	Left Turn	261	260	99.5%	10.5	1.6	B
	Through						
	Right Turn						
	Subtotal	261	260	99.5%	10.5	1.6	B
WB	Left Turn						
	Through						
	Right Turn						
	Subtotal						
Total		769	760	98.9%	6.4	1.9	A

Vissim Post-Processor  
Average Results from 10 Runs  
Volume and Delay by Movement

Snow Park Village  
2040 Plus Project - Bus Option  
PM Peak Hour

Intersection 7                      Deer Valley Drive East/P4 Parking                      Side-street Stop

Direction	Movement	Demand Volume (vph)	Served Volume (vph)		Total Delay (sec/veh)		
			Average	Percent	Average	Std. Dev.	LOS
NB	Left Turn						
	Through	200	217	108.3%	2.9	1.2	A
	Right Turn						
	Subtotal	200	217	108.3%	2.9	1.2	A
SB	Left Turn						
	Through	150	147	98.1%	11.2	15.7	B
	Right Turn	40	41	103.5%	2.4	4.1	A
	Subtotal	190	189	99.2%	9.5	14.1	A
EB	Left Turn	118	96	81.2%	17.5	2.9	C
	Through						
	Right Turn	50	70	140.8%	34.3	28.5	D
	Subtotal	168	166	98.9%	24.7	13.5	C
WB	Left Turn						
	Through						
	Right Turn						
	Subtotal						
Total		558	571	102.4%	11.7	8.2	B

Intersection 8                      Deer Valley Drive East/Pick-up/Drop-off                      Uncontrolled

Direction	Movement	Demand Volume (vph)	Served Volume (vph)		Total Delay (sec/veh)		
			Average	Percent	Average	Std. Dev.	LOS
NB	Left Turn						
	Through	200	217	108.4%	0.6	0.2	A
	Right Turn						
	Subtotal	200	217	108.4%	0.6	0.2	A
SB	Left Turn						
	Through	200	217	108.4%	14.2	9.0	B
	Right Turn						
	Subtotal	200	217	108.4%	14.2	9.0	B
EB	Left Turn						
	Through						
	Right Turn						
	Subtotal						
WB	Left Turn						
	Through						
	Right Turn						
	Subtotal						
Total		400	434	108.4%	7.5	4.8	A

Vissim Post-Processor  
Average Results from 10 Runs  
Queue Length

Snow Park Village  
2040 Plus Project - Bus Option  
PM Peak Hour

Intersection 101

Deer Valley Drive West/Deer Valley Drive East

Signal

Direction	Movement	Storage (ft)	Average Queue (ft)				Maximum Queue (ft)				Exceeds Storage?
			Average	Std. Dev.	Minimum	Maximum	Average	Std. Dev.	Minimum	Maximum	
NB	U Turn										
	Second Left										
	Left Turn										
	Through	500	93	4	88	102	279	15	257	306	NO
	Right Turn	500	93	4	88	102	279	15	257	306	NO
SB	Second Right										
	U Turn										
	Second Left										
	Left Turn	100	31	5	24	38	266	45	216	357	MAX
	Through	500	6	2	4	10	101	28	60	135	NO
EB	Right Turn										
	Second Right										
	U Turn										
	Second Left										
	Left Turn										
WB	Through										
	Right Turn										
	Second Right										
	U Turn										
	Second Left	500	8	2	5	10	54	7	45	69	NO
WB	Through										
	Right Turn	100	119	41	77	205	845	126	625	999	AVG
WB	Second Right										
	Second Right										

Vissim Post-Processor  
Average Results from 10 Runs  
Queue Length

Snow Park Village  
2040 Plus Project - Bus Option  
PM Peak Hour

Intersection 102

Deer Valley Drive West/Doe Pass Road

Side-street Stop

Direction	Movement	Storage (ft)	Average Queue (ft)				Maximum Queue (ft)				Exceeds Storage?
			Average	Std. Dev.	Minimum	Maximum	Average	Std. Dev.	Minimum	Maximum	
NB	U Turn	150	0	0	0	0	30	1	28	31	NO
	Second Left										
	Left Turn										
	Through										
	Right Turn										
Second Right											
SB	U Turn										
	Second Left										
	Left Turn										
	Through										
	Right Turn										
Second Right											
EB	U Turn	500	0	0	0	0	0	0	0	0	NO
	Second Left										
	Left Turn										
	Through										
	Right Turn										
Second Right											
WB	U Turn	100	0	0	0	0	0	0	0	0	NO
	Second Left										
	Left Turn										
	Through										
	Right Turn										
Second Right											



Vissim Post-Processor  
Average Results from 10 Runs  
Queue Length

Snow Park Village  
2040 Plus Project - Bus Option  
PM Peak Hour

Intersection 103

Deer Valley Drive East/Doe Pass Road

Signal

Direction	Movement	Storage (ft)	Average Queue (ft)				Maximum Queue (ft)				Exceeds Storage?
			Average	Std. Dev.	Minimum	Maximum	Average	Std. Dev.	Minimum	Maximum	
NB	U Turn	300	96	9	84	113	394	4	387	399	MAX
	Second Left										
	Left Turn										
	Through										
	Right Turn										
Second Right											
SB	U Turn	150	16	3	13	23	181	33	135	249	MAX
	Second Left										
	Left Turn										
	Through										
	Right Turn										
Second Right											
EB	U Turn	75	2	1	1	2	44	9	31	57	NO
	Second Left										
	Left Turn										
	Through										
	Right Turn										
Second Right											
WB	U Turn										
	Second Left										
	Left Turn										
	Through										
	Right Turn										
Second Right											

Vissim Post-Processor  
Average Results from 10 Runs  
Queue Length

Snow Park Village  
2040 Plus Project - Bus Option  
PM Peak Hour

Intersection 104

Solamere Drive/Deer Valley Drive East

Side-street Stop

Direction	Movement	Storage (ft)	Average Queue (ft)				Maximum Queue (ft)				Exceeds Storage?
			Average	Std. Dev.	Minimum	Maximum	Average	Std. Dev.	Minimum	Maximum	
NB	U Turn										
	Second Left										
	Left Turn										
	Through										
SB	Right Turn										
	Second Right										
	U Turn										
	Second Left										
EB	Left Turn	500	7	1	5	8	75	10	64	97	NO
	Through	500	8	1	6	9	75	10	64	97	NO
	Right Turn										
	Second Right										
WB	U Turn										
	Second Left										
	Left Turn	500	9	2	7	14	86	13	72	109	NO
	Through	500	0	0	0	0	0	0	0	0	NO
WB	Right Turn										
	Second Right										
	U Turn										
	Second Left										
WB	Left Turn	500	0	0	0	1	18	31	0	77	NO
	Through	500	0	0	0	1	18	31	0	77	NO
	Right Turn										
	Second Right										

Vissim Post-Processor  
Average Results from 10 Runs  
Queue Length

Snow Park Village  
2040 Plus Project - Bus Option  
PM Peak Hour

Intersection 105

Deer Valley Drive East/Queen Esther Drive

Side-street Stop

Direction	Movement	Storage (ft)	Average Queue (ft)				Maximum Queue (ft)				Exceeds Storage?
			Average	Std. Dev.	Minimum	Maximum	Average	Std. Dev.	Minimum	Maximum	
NB	U Turn										
	Second Left										
	Left Turn										
	Through	500	0	0	0	1	18	32	0	104	NO
	Right Turn	500	0	0	0	1	18	32	0	104	NO
SB	Second Right										
	U Turn										
	Second Left										
	Left Turn	500	9	2	7	11	89	16	64	109	NO
	Through	500	2	1	0	4	28	11	17	46	NO
EB	Right Turn										
	Second Right										
	U Turn										
	Second Left										
	Left Turn										
WB	Through										
	Right Turn										
	Second Right										
	U Turn										
	Second Left	500	6	1	5	9	65	9	57	88	NO
WB	Through										
	Right Turn	500	7	1	6	9	67	9	58	89	NO
WB	Second Right										
	Second Right										

Vissim Post-Processor  
Average Results from 10 Runs  
Queue Length

Snow Park Village  
2040 Plus Project - Bus Option  
PM Peak Hour

Intersection 1

P2 Parking/Doe Pass Road

Side-street Stop

Direction	Movement	Storage (ft)	Average Queue (ft)				Maximum Queue (ft)				Exceeds Storage?
			Average	Std. Dev.	Minimum	Maximum	Average	Std. Dev.	Minimum	Maximum	
NB	U Turn	150	68	0	67	68	104	1	103	106	NO
	Second Left										
	Left Turn										
	Through										
	Right Turn										
Second Right											
SB	U Turn										
	Second Left										
	Left Turn										
	Through										
	Right Turn										
Second Right											
EB	U Turn	125	0	0	0	0	1	3	0	10	NO
	Second Left										
	Left Turn										
	Through										
	Right Turn										
Second Right											
WB	U Turn	75	0	0	0	0	0	0	0	0	NO
	Second Left										
	Left Turn										
	Through										
	Right Turn										
Second Right											

Vissim Post-Processor  
 Average Results from 10 Runs  
 Queue Length

Snow Park Village  
 2040 Plus Project - Bus Option  
 PM Peak Hour

Intersection 2                      P1 Parking/Doe Pass Road                      Side-street Stop

Direction	Movement	Storage (ft)	Average Queue (ft)				Maximum Queue (ft)				Exceeds Storage?
			Average	Std. Dev.	Minimum	Maximum	Average	Std. Dev.	Minimum	Maximum	
NB	U Turn	150	2	0	2	2	57	2	56	62	NO
	Second Left										
	Left Turn										
	Through										
	Right Turn										
Second Right											
SB	U Turn										
	Second Left										
	Left Turn										
	Through										
	Right Turn										
Second Right											
EB	U Turn	125	0	0	0	0	0	0	0	0	NO
	Second Left										
	Left Turn										
	Through										
	Right Turn										
Second Right											
WB	U Turn	75	0	0	0	0	0	0	0	0	NO
	Second Left										
	Left Turn										
	Through										
	Right Turn										
Second Right											

Vissim Post-Processor  
Average Results from 10 Runs  
Queue Length

Snow Park Village  
2040 Plus Project - Bus Option  
PM Peak Hour

Intersection 3

Mobility Hub Entrance/Doe Pass Road

Side-street Stop

Direction	Movement	Storage (ft)	Average Queue (ft)				Maximum Queue (ft)				Exceeds Storage?
			Average	Std. Dev.	Minimum	Maximum	Average	Std. Dev.	Minimum	Maximum	
NB	U Turn										
	Second Left										
	Left Turn										
	Through										
	Right Turn										
SB	Second Right										
	U Turn										
	Second Left										
	Left Turn										
	Through										
EB	Right Turn										
	Second Right										
	U Turn										
	Second Left										
	Left Turn										
EB	Through	75	0	0	0	0	0	0	0	NO	
	Right Turn	75	0	0	0	0	0	0	0	NO	
WB	Second Right										
	U Turn										
	Second Left										
	Left Turn	100	1	0	1	1	105	0	105	106	MAX
	Through	100	1	0	1	1	105	0	105	106	MAX

Vissim Post-Processor  
Average Results from 10 Runs  
Queue Length

Snow Park Village  
2040 Plus Project - Bus Option  
PM Peak Hour

Intersection 4

Mobility Hub Exit/Doe Pass Road

Side-street Stop

Direction	Movement	Storage (ft)	Average Queue (ft)				Maximum Queue (ft)				Exceeds Storage?
			Average	Std. Dev.	Minimum	Maximum	Average	Std. Dev.	Minimum	Maximum	
NB	U Turn Second Left	100	27	5	20	39	152	18	127	176	MAX
	Left Turn Through										
	Right Turn Second Right	100	27	4	22	36	162	14	139	182	MAX
SB	U Turn Second Left										
	Left Turn Through										
	Right Turn Second Right										
EB	U Turn Second Left	100	0	0	0	0	0	0	0	0	NO
	Left Turn Through										
	Right Turn Second Right										
WB	U Turn Second Left	75	0	0	0	0	5	11	0	31	NO
	Left Turn Through										
	Right Turn Second Right										

Vissim Post-Processor  
Average Results from 10 Runs  
Queue Length

Snow Park Village  
2040 Plus Project - Bus Option  
PM Peak Hour

Intersection 5

Deer Valley Drive East/P2 Parking

Side-street Stop

Direction	Movement	Storage (ft)	Average Queue (ft)				Maximum Queue (ft)				Exceeds Storage?
			Average	Std. Dev.	Minimum	Maximum	Average	Std. Dev.	Minimum	Maximum	
NB	U Turn	160	3	2	1	8	132	42	93	215	NO
	Second Left										
	Left Turn										
	Through										
	Right Turn										
Second Right											
SB	U Turn	300	0	0	0	0	0	0	0	0	NO
	Second Left										
	Left Turn										
	Through										
	Right Turn										
Second Right											
EB	U Turn	150	81	2	78	83	111	1	110	112	NO
	Second Left										
	Left Turn										
	Through										
	Right Turn										
Second Right											
WB	U Turn										
	Second Left										
	Left Turn										
	Through										
	Right Turn										
Second Right											



Vissim Post-Processor  
Average Results from 10 Runs  
Queue Length

Snow Park Village  
2040 Plus Project - Bus Option  
PM Peak Hour

Intersection 6

Deer Valley Drive East/P3 Parking

Side-street Stop

Direction	Movement	Storage (ft)	Average Queue (ft)				Maximum Queue (ft)				Exceeds Storage?
			Average	Std. Dev.	Minimum	Maximum	Average	Std. Dev.	Minimum	Maximum	
NB	U Turn	200	4	1	2	6	122	21	80	150	NO
	Second Left										
	Left Turn										
	Through										
	Right Turn										
Second Right											
SB	U Turn	160	3	2	1	8	84	42	15	142	NO
	Second Left										
	Left Turn										
	Through										
	Right Turn										
Second Right											
EB	U Turn	150	64	1	63	66	91	1	90	92	NO
	Second Left										
	Left Turn										
	Through										
	Right Turn										
Second Right											
WB	U Turn										
	Second Left										
	Left Turn										
	Through										
	Right Turn										
Second Right											

Vissim Post-Processor  
Average Results from 10 Runs  
Queue Length

Snow Park Village  
2040 Plus Project - Bus Option  
PM Peak Hour

Intersection 7

Deer Valley Drive East/P4 Parking

Side-street Stop

Direction	Movement	Storage (ft)	Average Queue (ft)				Maximum Queue (ft)				Exceeds Storage?
			Average	Std. Dev.	Minimum	Maximum	Average	Std. Dev.	Minimum	Maximum	
NB	U Turn	100	0	0	0	0	0	0	0	0	NO
	Second Left										
	Left Turn										
	Through										
	Right Turn										
Second Right											
SB	U Turn	75	1	2	0	5	21	19	0	40	NO
	Second Left										
	Left Turn										
	Through										
	Right Turn										
Second Right											
EB	U Turn	150	12	7	5	30	148	23	108	184	NO
	Second Left										
	Left Turn										
	Through										
	Right Turn										
Second Right											
WB	U Turn	150	18	11	8	43	157	26	114	188	MAX
	Second Left										
	Left Turn										
	Through										
	Right Turn										
Second Right											

Vissim Post-Processor  
 Average Results from 10 Runs  
 Queue Length

Snow Park Village  
 2040 Plus Project - Bus Option  
 PM Peak Hour

Intersection 8

Deer Valley Drive East/Pick-up/Drop-off

Uncontrolled

Direction	Movement	Storage (ft)	Average Queue (ft)				Maximum Queue (ft)				Exceeds Storage?
			Average	Std. Dev.	Minimum	Maximum	Average	Std. Dev.	Minimum	Maximum	
NB	U Turn	150	0	0	0	1	41	29	0	101	NO
	Second Left										
	Left Turn										
	Through										
	Right Turn										
Second Right											
SB	U Turn	150	22	13	8	45	177	29	115	209	MAX
	Second Left										
	Left Turn										
	Through										
	Right Turn										
Second Right											
EB	U Turn										
	Second Left										
	Left Turn										
	Through										
	Right Turn										
Second Right											
WB	U Turn										
	Second Left										
	Left Turn										
	Through										
	Right Turn										
Second Right											

Vissim Post-Processor  
 Average Results from 10 Runs  
 Queue Length

Snow Park Village  
 2040 Plus Project - Bus Option  
 PM Peak Hour

Intersection 0

//

Signal

Direction	Movement	Storage (ft)	Average Queue (ft)				Maximum Queue (ft)				Exceeds Storage?
			Average	Std. Dev.	Minimum	Maximum	Average	Std. Dev.	Minimum	Maximum	
NB	U Turn										
	Second Left										
	Left Turn										
	Through										
	Right Turn										
SB	Second Right										
	U Turn										
	Second Left										
	Left Turn										
	Through										
SE	Right Turn										
	Second Right										
	U Turn										
	Second Left										
	Left Turn										
EB	Through										
	Right Turn										
	Second Right										
	U Turn										
	Second Left										
WB	Left Turn										
	Through										
	Right Turn										
	Second Right										
	U Turn										

Project: UT20-2245  
 Description: Snow Park Transportation Study

Park City Minimum Parking Rates Based <i>Nonshared</i> Parking Demand Summary																		
Land Use	Project Data		Weekday					Weekend					Weekday			Weekend		
			Base Ratio	Driving Adj	Non-Captive Ratio	Project Ratio	Unit For Ratio	Base Ratio	Driving Adj	Non-Captive Ratio	Project Ratio	Unit For Ratio	Peak Hr Adj	Peak Mo Adj	Estimated Parking Demand	Peak Hr Adj	Peak Mo Adj	Estimated Parking Demand
	Quantity	Unit											6 AM	December		6 AM	December	
Retail																		
Retail (<400 ksf)	25,866	sf GLA	3.22	100%	100%	3.22	ksf GLA	3.20	100%	100%	3.20	ksf GLA	100%	100%	84	100%	100%	83
Employee			0.78	100%	100%	0.78		0.80	100%	100%	0.80		100%	100%	21	100%	100%	21
Food and Beverage																		
Entertainment and Institutions																		
Convention Center	30,879	sf GLA	5.73	100%	100%	5.73	ksf GLA	5.73	100%	100%	5.73	ksf GLA	100%	100%	177	100%	100%	177
Employee			0.52	100%	100%	0.52		0.52	100%	100%	0.52		100%	100%	17	100%	100%	17
Hotel and Residential																		
Hotel-Business		keys	0.87	100%	100%	0.87	key	0.87	100%	100%	0.87	key	100%	100%	-	100%	100%	-
Hotel-Leisure	193	keys	0.87	100%	100%	0.87	key	0.87	100%	100%	0.87	key	100%	100%	168	100%	100%	168
Hotel Employees	193	keys	0.13	100%	100%	0.13	key	0.13	100%	100%	0.13	key	100%	100%	25	100%	100%	25
Restaurant/Lounge	5,451	sf GLA	4.24	100%	100%	4.24	ksf GLA	4.26	100%	100%	4.26	ksf GLA	100%	100%	24	100%	100%	24
Meeting/Banquet (0 to 20 sq ft/key)		sf GLA	0.00	100%	100%	0.00	ksf GLA	0.00	100%	100%	0.00	ksf GLA	100%	100%	-	100%	100%	-
Meeting/Banquet (20 to 50 sq ft/key)		sf GLA	0.00	100%	100%	0.00	ksf GLA	0.00	100%	100%	0.00	ksf GLA	100%	100%	-	100%	100%	-
Meeting/Banquet (50 to 100 sq ft/key)		sf GLA	0.00	100%	100%	0.00	ksf GLA	0.00	100%	100%	0.00	ksf GLA	100%	100%	-	100%	100%	-
Convention (100 to 200 sq ft/key)		sf GLA	0.00	100%	100%	0.00	ksf GLA	5.50	100%	100%	5.50	ksf GLA	100%	100%	-	100%	100%	-
Convention (> 200 sq ft/key)		sf GLA	4.58	100%	100%	4.58	ksf GLA	4.58	100%	100%	4.58	ksf GLA	100%	100%	-	100%	100%	-
Restaurant/Meeting Employees	5,451	sf GLA	0.76	100%	100%	0.76	ksf GLA	0.74	100%	100%	0.74	ksf GLA	100%	100%	5	100%	100%	5
Residential, Urban															0%			
Studio Efficiency		units	0.00	100%	100%	0.00	unit	0.00	100%	100%	0.00	unit	100%	100%	-	100%	100%	-
1 Bedroom	11	units	0.00	100%	100%	0.00	unit	0.00	100%	100%	0.00	unit	100%	100%	-	100%	100%	-
2 Bedrooms		units	0.00	100%	100%	0.00	unit	0.00	100%	100%	0.00	unit	100%	100%	-	100%	100%	-
3+ Bedrooms	132	units	0.00	100%	100%	0.00	unit	0.00	100%	100%	0.00	unit	100%	100%	-	100%	100%	-
Reserved	100%	res spaces	1.44	100%	100%	1.44	unit	1.41	100%	100%	1.41	unit	100%	100%	206	100%	100%	201
Visitor	143	units	0.06	100%	100%	0.06	unit	0.08	100%	100%	0.08	unit	100%	100%	9	100%	100%	13
Office																		
Additional Land Uses																		
Ski Resort (as observed during data collection)	1	count	1,500	100%	100%	1,500	count	1,500	100%	100%	1,500	count	100%	100%	1,500	100%	100%	1,500
Employee			0.00	100%	100%	0.00		0.00	100%	100%	0.00		100%	100%	-	100%	100%	-
															Customer/Visitor	1,962	Customer	1,965
															Employee/Resident	68	Employee/Resident	68
															Reserved	206	Reserved	201
															Total	2,236	Total	2,234

Project: UT20-2245  
 Description: Snow Park Transportation Study

Park City Minimum Parking Rates Based <i>Shared</i> Parking Demand Summary																		
Land Use	Project Data		Weekday					Weekend					Weekday			Weekend		
			Base Ratio	Driving Adj	Non-Captive Ratio	Project Ratio	Unit For Ratio	Base Ratio	Driving Adj	Non-Captive Ratio	Project Ratio	Unit For Ratio	Peak Hr Adj	Peak Mo Adj	Estimated Parking Demand	Peak Hr Adj	Peak Mo Adj	Estimated Parking Demand
	Quantity	Unit											1 PM	December		12 PM	December	
Retail																		
Retail (<400 ksf)	25,866	sf GLA	3.22	100%	97%	3.11	ksf GLA	3.20	100%	97%	3.09	ksf GLA	100%	100%	81	100%	100%	80
Employee			0.78	100%	100%	0.78		0.80	100%	100%	0.80		100%	100%	21	100%	100%	21
Food and Beverage																		
Entertainment and Institutions																		
Convention Center	30,879	sf GLA	5.73	100%	87%	4.97	ksf GLA	5.73	100%	87%	4.97	ksf GLA	100%	100%	153	100%	100%	153
Employee			0.52	100%	100%	0.52		0.52	100%	100%	0.52		100%	100%	17	100%	100%	17
Hotel and Residential																		
Hotel-Business		keys	0.87	49%	100%	0.42	key	0.87	53%	100%	0.46	key	55%	60%	-	55%	60%	-
Hotel-Leisure	193	keys	0.87	50%	100%	0.43	key	0.87	50%	100%	0.43	key	65%	50%	27	65%	50%	27
Hotel Employees	193	keys	0.13	100%	100%	0.13	key	0.13	100%	100%	0.13	key	100%	50%	13	100%	50%	13
Restaurant/Lounge	5,451	sf GLA	4.24	72%	90%	2.75	ksf GLA	4.26	72%	70%	2.15	ksf GLA	100%	100%	16	100%	100%	12
Meeting/Banquet (0 to 20 sq ft/key)		sf GLA	0.00	81%	90%	0.00	ksf GLA	0.00	36%	90%	0.00	ksf GLA	65%	100%	-	65%	100%	-
Meeting/Banquet (20 to 50 sq ft/key)		sf GLA	0.00	81%	90%	0.00	ksf GLA	0.00	36%	90%	0.00	ksf GLA	65%	100%	-	65%	100%	-
Meeting/Banquet (50 to 100 sq ft/key)		sf GLA	0.00	81%	90%	0.00	ksf GLA	0.00	36%	90%	0.00	ksf GLA	65%	100%	-	65%	100%	-
Convention (100 to 200 sq ft/key)		sf GLA	0.00	81%	90%	0.00	ksf GLA	5.50	36%	90%	1.78	ksf GLA	100%	100%	-	100%	100%	-
Convention (> 200 sq ft/key)		sf GLA	4.58	81%	90%	3.34	ksf GLA	4.58	36%	90%	1.49	ksf GLA	100%	100%	-	100%	100%	-
Restaurant/Meeting Employees	5,451	sf GLA	0.76	100%	100%	0.76	ksf GLA	0.74	100%	100%	0.74	ksf GLA	100%	100%	5	100%	100%	5
Residential, Urban																		
Studio Efficiency		units	0.00	100%	100%	0.00	unit	0.00	100%	100%	0.00	unit	50%	100%	-	68%	100%	-
1 Bedroom	11	units	0.00	100%	100%	0.00	unit	0.00	100%	100%	0.00	unit	50%	100%	-	68%	100%	-
2 Bedrooms		units	0.00	100%	100%	0.00	unit	0.00	100%	100%	0.00	unit	50%	100%	-	68%	100%	-
3+ Bedrooms	132	units	0.00	100%	100%	0.00	unit	0.00	100%	100%	0.00	unit	50%	100%	-	68%	100%	-
Reserved	100%	res spaces	1.44	100%	100%	1.44	unit	1.41	100%	100%	1.41	unit	100%	100%	206	100%	100%	201
Visitor	143	units	0.06	100%	100%	0.06	unit	0.08	100%	100%	0.08	unit	20%	100%	2	20%	100%	3
Office																		
Additional Land Uses																		
Ski Resort (as observed during data collection)	1	count	1,500	100%	100%	1,500	count	1,500	100%	100%	1,500	count	100%	100%	1,500	100%	100%	1,500
Employee			0.00	100%	100%	0.00		0.00	100%	100%	0.00		100%	100%	-	100%	100%	-
													Customer/Visitor	1,779	Customer		1,776	
													Employee/Resident	56	Employee/Resident		56	
													Reserved	206	Reserved		201	
													Total	2,041	Total		2,032	

Shared Parking Reduction 9% 9%



# **Attachment A: Trip Generation Memorandum**



## MEMORANDUM

Date: January 21, 2022  
To: Alexandra Ananth, Park City Planning  
From: Fehr & Peers  
Subject: **Revised Trip Generation Estimates for the Snow Park Village Traffic Impact Study**

UT20-2245

---

This memorandum presents revised trip generation estimates for the proposed Snow Park Village project at Deer Valley Resort. The original trip generation estimates included in the Traffic Impact Study (April 2021) were reviewed by Park City staff and Wall Consulting Group (WCG), a third-party reviewer retained by the City. Park City staff, through WCG, requested revisions to the trip generation estimates with supporting documentation and/or rationale. Revisions presented in this memorandum are based on an updated land use plan, a local precedent study, comparable trip resort analysis, published trip generation rates from the Institute of Transportation Engineers, and mode shift assumptions derived from the Summit County travel demand model. This memorandum is an intermediate deliverable while additional details regarding site access and circulation are being resolved.

In summary, revised trip generation estimates for the Snow Park Village project show 2,276 daily trips, 162 trips in the Saturday AM peak-hour, and 204 trips in the Saturday PM peak hour. When compared with estimates included in the April 2021 traffic impact study, this results in a 60 percent increase in estimated daily trips, 80 percent increase in the Saturday AM peak-hour trips, and a 148 percent increase in the Saturday PM peak-hour trips.

## Trip Generation Estimates

Trip generation estimates focus on Saturday AM and PM peak-hour operations due to the nature of how a ski resort operates: skier traffic is consistently highest on Saturdays. Updated trip generation estimates for Snow Park Village are presented below in **Table 1**.





## Key Revisions

Trip generation estimates in this memorandum incorporate several key revisions, including:

- Updated resort hotel trip generation rates taken from the 2018 Canyons Village Transportation Master Plan
- Assumed mode shift away from private car taken from MXD, the Environmental Protection Agency's approved trip generation method, and the Summit County travel demand model for all proposed land uses
- Reductions in trip generation rates due to the implementation of paid parking for day skiers and most proposed land uses
- Reliance on trip internalization derived from MXD and the Summit County travel demand model for most proposed land uses
- The rate of internal capture assumed due to complementary land uses derived from analysis at a peer resort (Palisades at Tahoe, formerly known as Squaw Valley)

This combination of updates represents a much more conservative foundation for subsequent traffic analysis. Each of these changes and justification for each are described in greater detail below.

### Resort Hotel Trip Generation Rates

The third-party reviewers (WCG) noted that the resort hotel trip generation rates appeared unreasonably low based on observed trip generation rates recorded during the development of the 2018 Canyons Village Transportation Master Plan. While there are a handful of key factors that might result in trip generation rates closer to those in the original Snow Park Village Traffic Impact Study, including proximity to the interstate and other complementary land uses, estimates in this memorandum used the local rates recorded at the Canyons.

### Assumed Mode Shift

To avoid double-counting potential reductions, as was the case in the original Snow Park Village traffic impact study, the trip generation estimates in this memorandum rely solely on mode shift derived from the MXD methodology and underlying assumptions from the regional travel demand model. These reductions, which are shown in the columns titled "% Walk/Bike" and "% Transit," are applied to all proposed land uses. This results in a more conservative and defensible analysis,



however, it does not account for the planned changes to transit service in Park City and the world-class transit facility proposed as part of the Snow Park Village project. Potential mode shift to transit for those traveling to and from Deer Valley may be higher following such improvements.

## **Reduction in Vehicle Trips due to Implementation of Paid Parking**

Charging for parking is a reliable method by which to influence mode choice, and Deer Valley intends to implement paid parking as part of the Snow Park Village proposal. The original Snow Park Village traffic study assumed a reduction in vehicle trips of nearly 18% and applied it to all land uses. This reduction was developed based on approximately 50 studies on the effects of paid parking from across the United States. WCG noted this reduction seemed high based on assumptions about typical Deer Valley clientele and their assumed willingness to pay for fees in addition to lift tickets, meal, lessons, and/or equipment rentals.

Reductions in trip generation due to the implementation of paid parking at Deer Valley have been scaled back to present a more conservative estimate of how parking pricing will affect trip generation. While we agree that some Deer Valley clientele may be much less sensitive to additional costs associated with a day's skiing as presented in the traffic study, almost 45% of existing trips to and from Deer Valley start and end at points along the Wasatch Front, residents of which are more likely to alter their behavior based on willingness to pay (note the massive increase in peripheral on-street parking at a greater distance to ski lifts at Deer Valley's IKON pass-sharing resort, Solitude). Lastly, reductions in trip generation due to the implementation of parking pricing are applied only to the resort hotel-, shopping center-, and recreational community center-generated trips, as proposed residential uses at the site are unlikely to require that residents pay for parking on a daily basis.

## **Trip Internalization Derived from MXD**

A fundamental element of the Snow Park Village proposal is to provide amenities, services, and entertainment options that complement each other and the ski resort itself. This means that peak-hour trips that might occur without complementary land uses are either delayed (so that they do not occur during the peak hours) or do not require a vehicle trip due to proximity of different uses. Trip internalization rates, presented in **Table 1** under the column heading "% Internal Capture" are applied only to the residential-, resort hotel-, and recreational community center-generated trips, and present a more conservative rate of internalization than presented in the original Snow Park Village traffic impact study.



## Trip Internalization Derived from Squaw Valley

While the residential, hotel, and community center uses are expected to be destinations unto themselves that will generate a measurable number of peak-hour vehicle trips, the food service and retail uses (shown in **Table 1** as "Shopping enter") are expected to almost exclusively serve guests already at Deer Valley rather than guests traveling to Deer Valley explicitly for those services.

To support this assumption, trip generation estimates for the shopping center uses in this memorandum rely on trip internalization estimates derived from an origin-destination survey conducted at the Squaw Valley, California resort in 2011. Surveys conducted showed that 95-97% of customers at dining and retail uses in a similar context (ski resort base village) were already at the village for other purposes, and did not travel solely for the dining/retail use. Reductions based on the data from Squaw Valley are presented under the column heading "% Resort Int. Capt." And are applied only to the shopping center uses. We assume that employees for these uses will almost exclusively arrive and depart during off-peak periods, resulting in lower reductions for daily trips generated by the shopping center uses.

## Conclusion

Trip generation estimates prepared for the original Snow Park Village traffic impact study were based on an older land use plan, double-counted some reductions in vehicle trips, applied others to incorrect land uses, and over-emphasized the potential reductions in vehicle trips derived from paid parking. However, this memorandum relies on several assumptions that are fundamental to the Snow Park Village proposal:

- Complementary land uses will reduce peak-hour vehicle trips by providing alternatives to driving
- Employees will typically arrive and depart during off-peak periods
- Charging for parking is one of the most powerful tools available for influencing mode choice, relying on an appropriate pricing structure being implemented

The trip generation estimates presented in this memorandum represent a conservative set of analyses that will inform a fully revised traffic impact study for the Snow Park Village Project.



# **Attachment B: Snow Park Village Parking Management Plan**



## MEMORANDUM

Date: January 21, 2022  
To: Rich Wagner, Deer Valley  
From: Fehr & Peers  
Subject: **Snow Park Village MPD Parking Response**

*UT20-2245*

---

The current parking experience at Deer Valley follows a well-established surface parking scenario, typical of ski resorts. There are five large surface lots that hold approximately 1,340 cars. There is also a long-standing agreement with Park City to allow for overflow parking on parts of Deer Valley Drive on peak visitation days.

### Parking Layout

The proposed redevelopment of the base area (Snow Park) will change the parking experience in three significant ways:

- Parking will be in structures;
- There will be a paid parking program, with variable pricing based on season and demand;
- There will be a robust parking management program that includes parking and availability information to visitors as they approach the development, parking garages, and once within, and will rely heavily on Deer Valley's high-quality customer service provided by trained staff.

For phase 1, the proposed parking garages will be on four levels. Each level will have a prescribed function as outlined below. Parking loading will be managed level by level, utilizing guest services staff and electronic messaging. To help ensure that the majority of traffic coming to Snow Park does not conflict with transit on Doe Pass Road, signing, striping, and prominent wayfinding will direct the majority of personal vehicles to use Deer Valley Drive East to enter the garages, while transit and shuttle vehicles will be directed to Deer Valley Drive West and/or Doe Pass Road. The primary entrances to the garages, for levels P2, P3, and P4, will be from Deer Valley Drive East. There are no internal garage connections between levels allowing each level of the garage to serve



as an independent programmable parking resource. The layout and uses are shown in the attached *Parking Allocation* figure.

**P1 Parking** – this level will be divided between two user groups with a total of 406 stalls. Hotel/condo uses will have 202 stalls. The other 204 stalls may be utilized by valet parking and/or credentialed access users. Access to this area is from Doe Pass near the intersection Deer Valley Drive west. Due to its restricted uses, demand for spaces on P1 is expected to be relatively low, with hotel patrons parking vehicles for multiple days at once. In addition, it is unlikely that all hotel patrons will need to park at times that coincide with peak day skier arrival, further reducing the expected number of vehicles on Doe Pass Road during peak hours.

**P2 Parking** – this level will have 368 stalls. It will primarily be used for winter day skiers and summer resort guests during those seasons, transient parking and special event parking during event periods. Access is provided on Deer Valley Drive East, however an auxiliary exit is provided accessing Doe Pass to add flexibility in managing egress and minimize potential congestion during periods of peak parking demand and special events.

**P3 Parking** – the primary users for this level will be similar to P2; day users, transient parking, special event parking as well as space dedicated to ski school drop-off/pick-up. There are 375 stalls for these uses. There are an additional 80 stalls for hotel/condo use, for a total of 455 stalls. Access is primarily to/from Deer Valley Drive, however an auxiliary entrance/exit is provided accessing Deer Valley Drive West/Royal Street intersection, which will be dedicated to hotel and condominium uses.

**P4 Parking** – there are 90 stalls for ski school, valet, and short-term parking on this level. “Short-term” means for visitor parking less than 30 minutes for such purposes as pick-up/drop-off, kiss ‘n’ ride, and so on. The balance of the parking on this level is 41 for hotel/condo uses.

**North Parcel** – The north parcel will consist of an additional 450 stalls. These will initially remain surface parking. This area will eventually consist of two levels, NP1 and NP2, and the total parking stalls will remain at 450. The north parcel will have the same level of parking management, including paid parking, and parking management technology, communications via multiple platforms, and high-touch customer service.

Structured parking layouts are shown below in **Figure 1**.

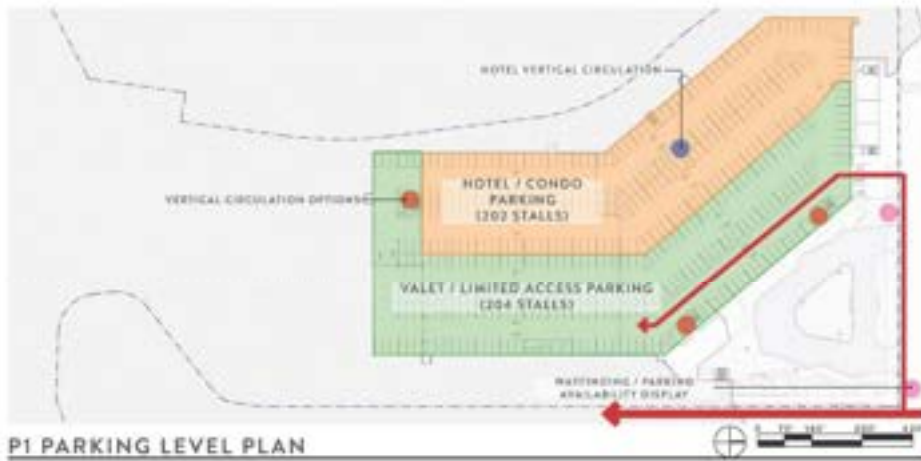

Source: IBI Group

Figure 1  
Parking Level Layouts





## **Paid Parking**

A paid parking scheme will be implemented in a manner that ensures transactions for inbound traffic do not cause delays which could impact adjacent streets. The price will vary by season and is an important tool to encourage all visitors to travel by modes other than driving alone. Signs and parking processes will be designed to maximize efficiency and minimize congestion.

Recognizing that the much of the typical clientele of Deer Valley are less price-sensitive than many potential parkers, pricing may be adjusted following initial implementation to ensure that the preferred reductions in peak parking demand are achieved.

## **Communications**

To achieve the smoothest parking operations possible, parking information will be made available on Deer Valley's website and integrated into any platforms through which ski passes might be purchased. Additionally, hotel and condominium uses will be expected to incentivize arrival options that do not require parking on-site.

Parking availability by level will be integrated into the design of Snow Park. Parking information will be part of the dynamic wayfinding program included in the development. This information will be available to the visitor via electronic messaging at key decision points along Deer Valley Drive East, including at the newly-configured "Y" intersection of Deer Valley Drives East and West, and as the driver approaches the garage entrances. Parking communication may also be integrated into various phone and web apps operated by the resort, city, county, etc.

Once inside the parking levels, parking availability and general internal wayfinding will be incorporated into the design to improve access rates, guiding visitors to available spaces. The exact technologies and vendors have not been determined at this point, but it will employ the most appropriate and technologically advanced parking and transportation systems to ensure an efficient and user-friendly parking experience with minimal impact on adjacent streets.





# **Attachment C: Snow Park Village Transportation Demand Management Plan**

# **Snow Park Village**

## **TDM Plan**

**Prepared for:  
Deer Valley**

October 2022

UT20-2245

**FEHR**  **PEERS**

## **Table of Contents**

---

1. Project Description and TDM Approach.....	4
1.1 Project Description .....	4
1.2 TDM Approach .....	6
2. Snow Park Village TDM Program .....	8
2.1 Primary TDM measures.....	8
3. Program Monitoring and Adaptation .....	14
3.1 Monitoring Program.....	14
3.1.1 Annual Monitoring Report .....	15

## **Table of Figures**

---

Figure 1: Project Location .....	5
Figure 2: Deer Valley Traveler Origins and Destinations .....	7

*This page intentionally left blank.*

# 1. Project Description and TDM Approach

This Transportation Demand Management (TDM) Plan describes the proposed approach to reduce the total number of vehicle trips at the Snow Park Village project at Deer Valley Resort in Park City, Utah. The Park City Municipal Corporation (PCMC), through its planning department review of the project application, has requested that a standalone TDM Plan be developed for the project. In addition, the City adopted a TDM Plan in 2016 that specifies how the City seeks to reduce vehicle trips through TDM strategies. A reduction in vehicle trips will reduce local pollution, greenhouse gas emissions and improve the quality of life for all who live and work in Park City by reducing vehicle traffic.

This document describes how Deer Valley intends to reduce the number of single-occupancy vehicle (SOV) trips to Snow Park Village using a variety of TDM options. This plan is based heavily on PCMC's existing TDM plan and strategies therein, adopted in August 2016.

Additionally, this plan formalizes TDM offerings that are already provided by Deer Valley to guests and employees for some time. In addition to describing existing offerings, this plan includes new TDM measures to help reduce SOV trips and monitor program effectiveness through ongoing collaboration with PCMC staff and other major destinations in Park City.

## 1.1 Project Description

Snow Park Village proposes to repurpose the existing surface parking lots of the Snow Park base area at Deer Valley Resort for a mixed-use development including hotel, residential, retail and events center uses. Snow Park Village is approximately 1.5 miles from downtown Park City and approximately 2.5 miles from the Park City Mountain Resort base area. Snow Park Village's location in Park City is shown in **Figure 1**.

The bulk of activity at the Snow Park Village is expected to take place during normal business hours. Parking at the site will be priced and include standard and ADA-compliant spaces. Central to the success of the project, a multimodal mobility hub is proposed on Deer Valley Drive, will facilitate non-automobile connections to key destinations in Park City, elsewhere in Summit County, and the Salt Lake Valley. Full build-out of Snow Park Village will include a network of dedicated pedestrian paths within the project, as well as connections to area cycling and pedestrian facilities.



## 1.2 TDM Approach

The success of a TDM program relies on creating a system to manage travel demand that shifts the behavior of those traveling to and from Snow Park from using single occupant vehicles to options other than driving alone. The following sections describe the menu of transportation choices that will make it easier and more convenient to use modes other than driving alone. Through an evaluation of anonymized mobile phone data, provided by a third-party vendor, this Plan has been assembled with the knowledge that a substantial portion of those traveling to and from Deer Valley do so from points around the region. The origins and destinations of Deer Valley’s guests and employees are dispersed throughout northern Utah, with the largest share traveling to and from points along the Wasatch Front, as shown in **Figure 2**. This variety of travel patterns requires a robust and diverse program to reduce drive alone trips. A diverse and flexible TDM program will allow Deer Valley to match the transportation services to the travel needs of all traveling to and from Snow Park Village. The TDM Plan described in the following sections supports the project’s commitment to managing vehicle traffic to and from Snow Park Village while maintaining flexibility in response to changing travel behavior and regional transportation investments.



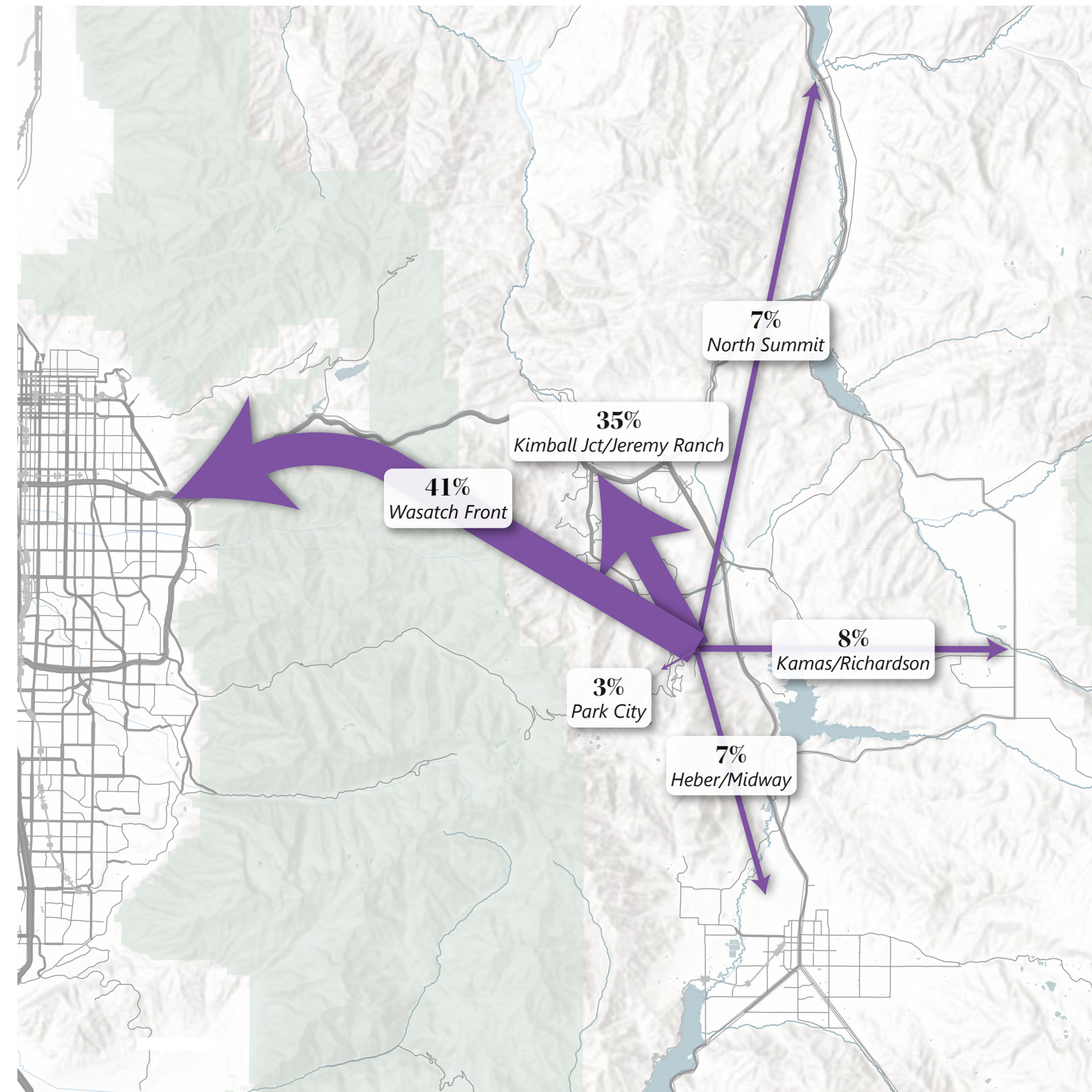
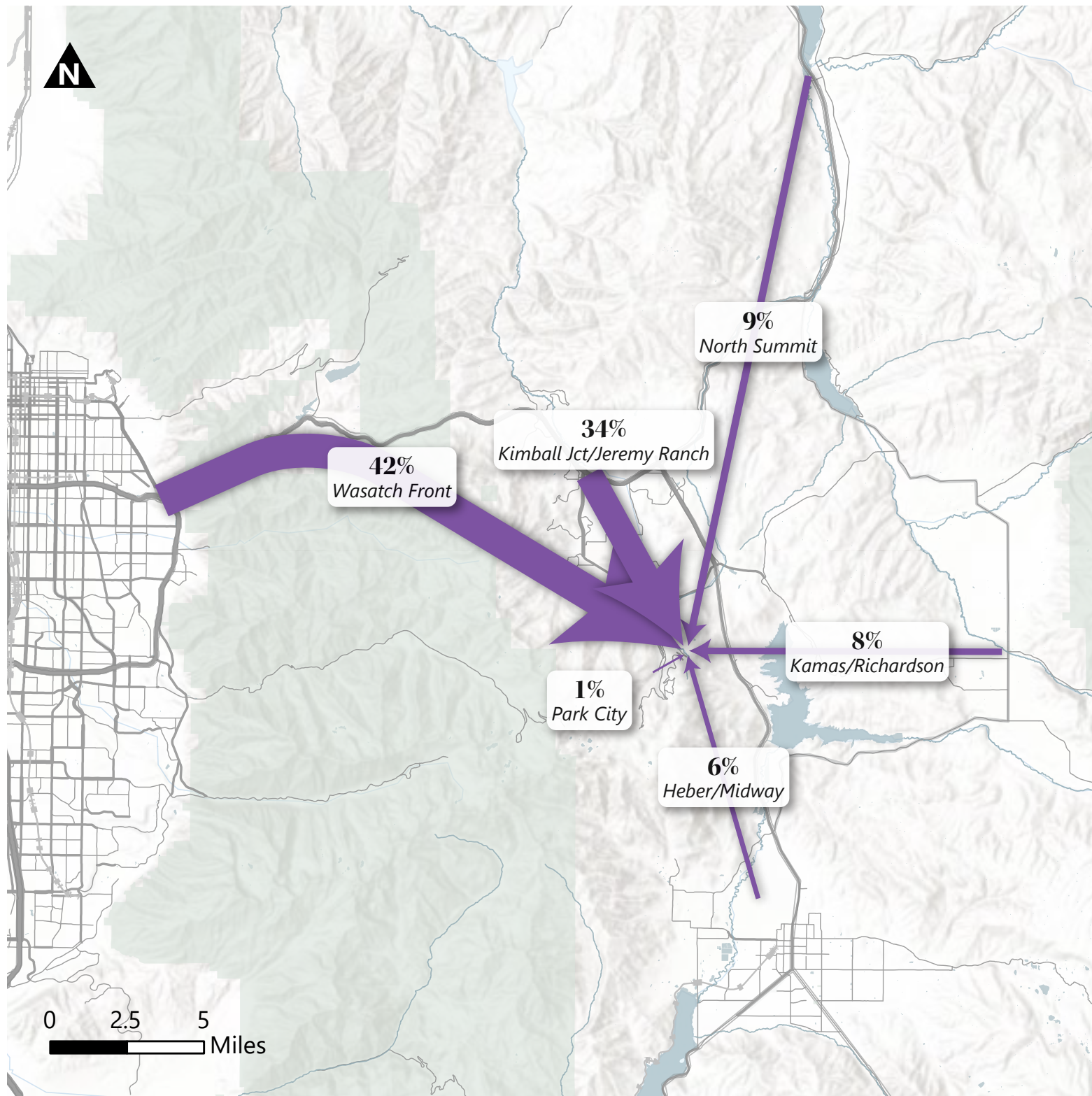

Figure 2  
Deer Valley Origin-Destination AM Incoming – PM Outgoing Trends 



# 2. Snow Park Village TDM Program

## 2.1 Primary TDM measures

Deer Valley will provide a variety of opportunities for those traveling to and from Snow Park to choose travel modes that are not driving alone. These are categorized as incentivizing using transit, riding a bicycle, sharing a car, or some combination thereof. A summary of the Primary TDM measures can be found in **Table 1**.

**Table 1: Primary TDM Measures**

Measure	Status	Description
Transit pass subsidy	Existing Program	Subsidized UTA transit passes for Deer Valley employees living in Salt Lake Valley and Utah Valley
Bicycle Amenities and Perks	New Program	Bicycle repair tools and dedicated bicycle parking at key locations
Education and Promotion	Existing Program	Educational and promotional events to encourage travelers to use by modes other than driving alone.
Parking Management	New Program	Efficient, constrained, and priced parking to discourage drive-alone trips
Employee Transit	Existing Program	Operate designated employee transit to facilitate efficient employee commutes through an appealing alternative
Real-Time Messaging	New Program	Communicate traffic conditions in real time to travelers
Appoint a TDM Coordinator	New Program	Identify a staff member to oversee the TDM program

Source: Deer Valley

More detailed descriptions of the Primary TDM Measures can be found below.

To incentivize traveling by bicycle, Deer Valley plans to implement the bicycling-based TDM strategies listed in **Table 2**.

**Table 2: Bicycling and Walking TDM Strategies**

Biking/Walking Strategies	Status	Target User Groups	Description
<b><i>Implement Bicycle Parking at Key Destinations and Transit Stops</i></b>	New Program	Day Guests Commuters Employees	Snow Park Village’s site plan includes the provision of safe and convenient locations to park bicycles, encouraging their use and removing barriers such as frustration in finding secure parking and bicycle theft. This includes the proposed mobility hub on Deer Valley Drive, a key connecting point for trips to and from Snow Park.
<b><i>Expand e-Bike Share</i></b>	New Program	Day Guests Commuters Employees	Snow Park Village will include a relocated PCMC e-bike-share station with direct access to the mobility hub. This will expand coverage of the existing e-bike share service in Park City and enable more non-automobile trips for people traveling to and from Snow Park Village.
<b><i>Install Bicycle Repair Stand</i></b>	New Program	Day Guests Commuters Employees	Deer Valley will install two do-it-yourself bicycle repair stands: one at the proposed mobility hub on Deer Valley Drive, and another seasonal stand at the Silver Lake Express base. The repair stands may include an air pump and basic tools to make minor bicycle repairs. Additional repair options include full-service bike shop(s) during the summer season and on-mountain assistance from Bike Patrol.

Source: Deer Valley

To incentivize traveling by modes other than driving alone, Deer Valley plans to implement the parking-based TDM strategies listed in **Table 3**.

**Table 3: Demand Management TDM Strategies**

Demand Management Strategies	Status	Target User Groups	Description
<b><i>Implement Real-Time Information Messaging</i></b>	New Program	Day Skiers Employees	Deer Valley plans to work with the City, UDOT, and Summit County to deploy VMS boards and other messaging systems at key locations, including approach roads, parking areas, and ski lift bases, to inform those traveling to and from Snow Park Village of current traffic and parking conditions. Additionally, Deer Valley will use its website, social media platforms, and mobile application to notify guests in real time. This will enable

			visitors to make more informed transportation choices allowing for better demand management.
<b>Provide Additional Evening Recreation Opportunities/Amenities:</b>	New Program	Day Skiers Employees Overnight Guests	Providing additional activities, food and beverage options, and/or entertainment for visitors after the ski day has ended is an essential element of the Snow Park Village proposal. Providing opportunities for day skiers to linger at the base area longer will better distribute peak-hour outbound vehicle trips.

Source: Deer Valley

To incentivize traveling by modes other than driving alone, Deer Valley plans to implement the parking-based TDM strategies listed in **Table 4**.

**Table 4: Policy-Based TDM Strategies**

Policy Strategies	Status	Target User Groups	Description
<b>Provide Employee Housing</b>	Existing Program	Employees	Deer Valley has and will continue to provide subsidized housing for its employees in and around Park City. The locations of this housing allow for shorter commutes with access to public transit or shuttles, and increases the likelihood of ridesharing among employees. Any active, full-time staff member is eligible for employee housing. Employee housing is distributed throughout Park City and Heber City in areas that are served by public and employee transit.
<b>Provide Employee Amenities</b>	Existing Program	Employees	Deer Valley employees are able use various on-site amenities that will be provided at Snow Park Village, including employee dining rooms that offer discounted meals, and employee locker rooms that allow for storage of personal items to reduce the need for trips off-site during shift changes and during mealtimes.
<b>Childcare</b>	Existing Program	Day Skiers Employees Overnight Guests	Parents managing childcare are among those who are most attached to private vehicles for personal travel, and providing on-site childcare in the form of both nursery/day care programs, and on-mountain options for active childcare will reduce the need for parents to make multiple local trips and enable their use of non-SOV modes by collocating services. Deer Valley employees are eligible for discounted childcare programs.

Source: Deer Valley

To incentivize traveling by modes other than driving alone, Deer Valley plans to implement the parking-based TDM strategies listed in **Table 5**.

**Table 5: Parking TDM Strategies**

Parking Strategies	Status	Target User Groups	Description
<b>Implementation of Efficient Parking Schemes</b>	Existing Program	Day Skiers Employees	Deer Valley will continue to assess the need for remote or satellite parking areas for days on which parking demand requires additional capacity beyond that which is provided at the base area itself. The only designated off-site parking location that has been used by Deer Valley is Treasure Mountain Middle School, and is used solely on days of particularly high demand.
<b>Implement Parking Demand Management</b>	New Program	Day Skiers Employees	A fundamental aspect of Snow Park Village’s proposed parking system is to charge for parking, a direct incentive to those traveling to Deer Valley to more efficiently utilize vehicle capacity, specifically for day skiers. The cost of parking at Snow Park Village will be set at a level that will incentivize higher-occupancy vehicles when traveling to and from Snow Park, a direct disincentive to drive alone. While many Deer Valley patrons are likely less price sensitive to additional charges such as paid parking, available data suggests that a substantial portion of day traffic originates from points along the Wasatch Front, from where patrons are expected to be more price sensitive to parking fees, increasing their likelihood of mode shift.

Source: Deer Valley

To incentivize traveling by modes other than driving alone, Deer Valley plans to implement the programmatic TDM strategies listed in **Table 6**.

**Table 6: Program-Based TDM Strategies**

Programmatic Strategies	Status	Target User Groups	Description
<b><i>Establish a TDM Coordinator</i></b>	New Program	Employees Day Skiers Overnight Guests	Deer Valley will identify an existing staff member to act as the TDM coordinator, a central source for TDM program information. The TDM coordinator may fill many roles, but may be responsible for: real-time messaging of traffic conditions to travelers, distribute information on new or adapted TDM program offerings, and evaluate the effectiveness and use of TDM program elements. The TDM coordinator will also continue to explore new TDM options that best serve Deer Valley guests and/or employees. The TDM coordinator will be the main point of contact with the City and will facilitate communication in connection with the proposed monitoring program. This coordinator will meet with Park City staff on a regular basis to discuss on-going adjustments to the TDM measures.
<b><i>Provide Tailored Information and Promotions</i></b>	Existing Program	Employees Day Skiers Overnight Guests	Deer Valley will develop and distribute targeted messaging and promotions to ensure that different user groups are aware of the TDM measures most relevant to their needs. These promotions may include gamification to further incentivize non-drive alone trips. Deer Valley supports a mobile app used by employees that allows them to organize rides sharing, and identify transit, bike and walking options for their commute. The application also offers incentives to Deer Valley employees for not driving alone to work. Deer Valley will encourage all ski area-serving businesses (namely hotels and other lodging) to further emphasize their transportation offerings that allow guests to rely less on private vehicles and more on shared mobility.

Source: Deer Valley

To incentivize traveling to and from Snow Park by transit, Deer Valley plans to implement the transit-based TDM strategies listed in **Table 7**.

**Table 7: Transit TDM Strategies**

Transit Strategies	Status	Target User Groups	Description
<b><i>Provide Employee Transit</i></b>	Existing Program	Employees	To complement public transit service and supplement in certain areas where public transit may not yet exist, Deer Valley will continue to provide private employee transit to and from Snow Park to allow Deer Valley employees to travel longer distances (such as from Heber City) on employee shuttles. Deer Valley contracts through Le Bus to operate full-sized coach buses for their employees. In a typical (non-Covid) year, Deer Valley provides three AM peak-period and two PM peak-period shuttle runs to serve their employees living in River's Edge and Heber City.
<b><i>Subsidize Transit Passes for Inter-City Commuters</i></b>	Existing Program	Employees	Deer Valley provides subsidized Utah Transit Authority passes to employees commuting to Deer Valley from Utah and Salt Lake Valleys.

Source: Deer Valley

## 3. Program Monitoring and Adaptation

Deer Valley has a strong interest in making trips to and from Snow Park Village as efficient and enjoyable as possible. Doing so is not only a way to improve the overall experience for all who visit Snow Park, but it also allows Deer Valley to contribute to shared goals for reducing traffic impacts within Park City and Summit County.

### 3.1 Monitoring Program

Deer Valley will conduct internal monitoring to best understand how various user groups are getting to Snow Park, how best to improve their experiences, and how to optimize their experience while minimizing their impact on area traffic and the environment. Elements of the TDM program may be adapted, added, or eliminated over time as Deer Valley strives to achieve maximum effectiveness with its TDM program. The Snow Park TDM program will change over time as travel behaviors change and the transportation context around Snow Park evolves.

Ongoing, real-time traffic monitoring will be enabled by a Deer Valley-funded and managed monitoring traffic monitoring station at the Deer Valley Drive / Deer Valley Drive East / Deer Valley Drive West intersection. This will allow for ongoing traffic counts, recording of queueing via still imagery, and year-over-year comparison at a crucial intersection in Park City.

The TDM coordinator will be responsible for ongoing collaboration and coordination with PCMC staff to ensure that goals are shared and TDM measures managed by Deer Valley are complementing those enacted by the City. To that end, semiannual meetings will take place among Deer Valley, PCMC staff, and other TDM coordinators:

- Prior to each ski season, relevant parties will gather to share relevant updates for the upcoming season, and identify potential opportunities for collaboration, share expectations for the coming months, and discuss performance metrics to be tracked
- Following each ski season, the same parties will meet to share lessons learned and review program performance as recorded by agreed-upon performance metrics, and establish potential action items during the off-season

With ongoing updates to local transit service operated by both Park City Transit and High Valley Transit, Deer Valley will strive to avoid duplication of transit service offerings. Deer Valley's TDM program is intended to support the use of public transit among the public rather than act as an alternative to public

transit service. As public transit coverage expands, Deer Valley will adapt its program to support local transit agencies.

### **3.1.1 Annual Monitoring Report**

To evaluate the effectiveness of Deer Valley's TDM program, and inform potential adjustments to the program, Deer Valley will develop an annual monitoring report to be submitted to Park City staff for review. Submittal of this report will fall between semi-annual meeting with Park City staff and other TDM program managers in Park City.

To the greatest extent possible, data collected for this monitoring effort will rely on existing or to-be-implemented sources. This will improve consistency across monitoring periods and allow for flexibility around weather or other events if needed.

Deer Valley will collect the following types of data for their TDM monitoring effort:

- Seven-day vehicle counts at all Snow Park Village driveways, to be analyzed and summarized by a third-party consultant. This data will be analyzed and summarized by a third-party consultant
- Average vehicle occupancy collected on one weekday and one weekend day, collected by a third-party vendor or Deer Valley staff, to be analyzed and summarized by a third-party consultant
- Ski season transit ridership, summarized at the stop and daily levels and provided by transit operators, to be analyzed and summarized by a third-party consultant
- Available data regarding program utilization from the *Ride On Park City* platform, to be analyzed and summarized by a third-party consultant

If additional or revised analyses are requested by the City, those requests can be reviewed and possibly scoped in advance of the first monitoring report.