

# DEER VALLEY DRIVE IMPROVEMENT PLAN

## BUS/FLEX LANE PRIORITY OPTION

DEDICATED 11'-W BUS/BIKE FLEX LANE, NO SHOULDERS

DEER VALLEY RESORT  
2250 DEER VALLEY DR  
PARK CITY, UTAH 84060

NOVEMBER 16, 2022



DEER VALLEY  
RESORT

CIVIL ENGINEER

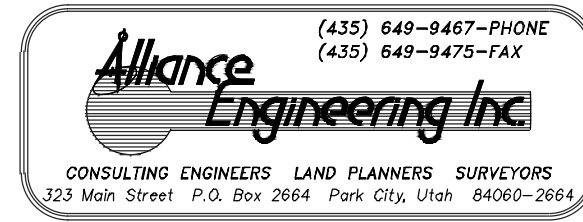

### SHEET INDEX

1. OVERALL
2. Y-INTERSECTION
3. SOLAMERE DR. & QUEEN ESTHER DR.
4. OVERALL GARAGE
5. DOE PASS
6. DEER VALLEY DR. (WEST)

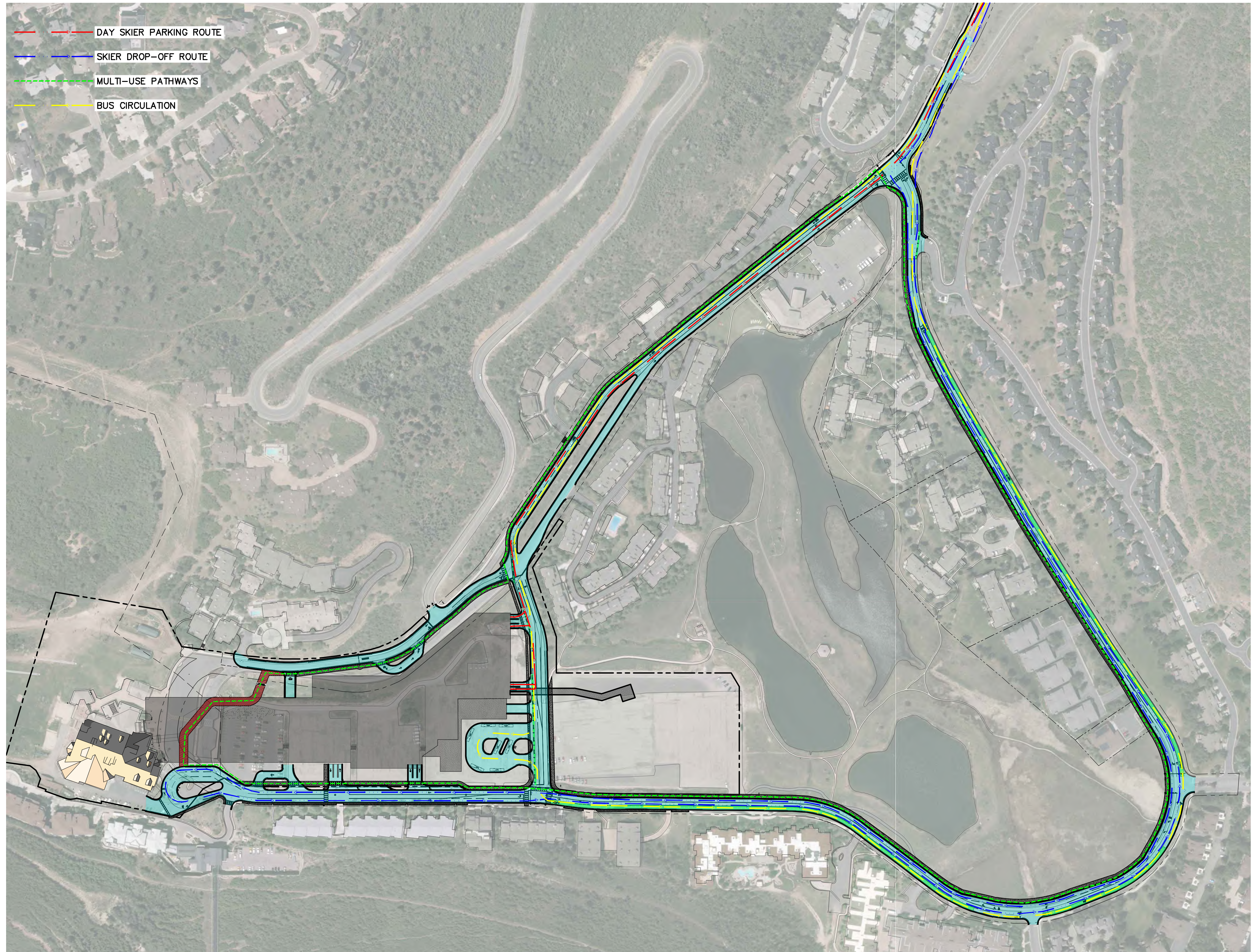

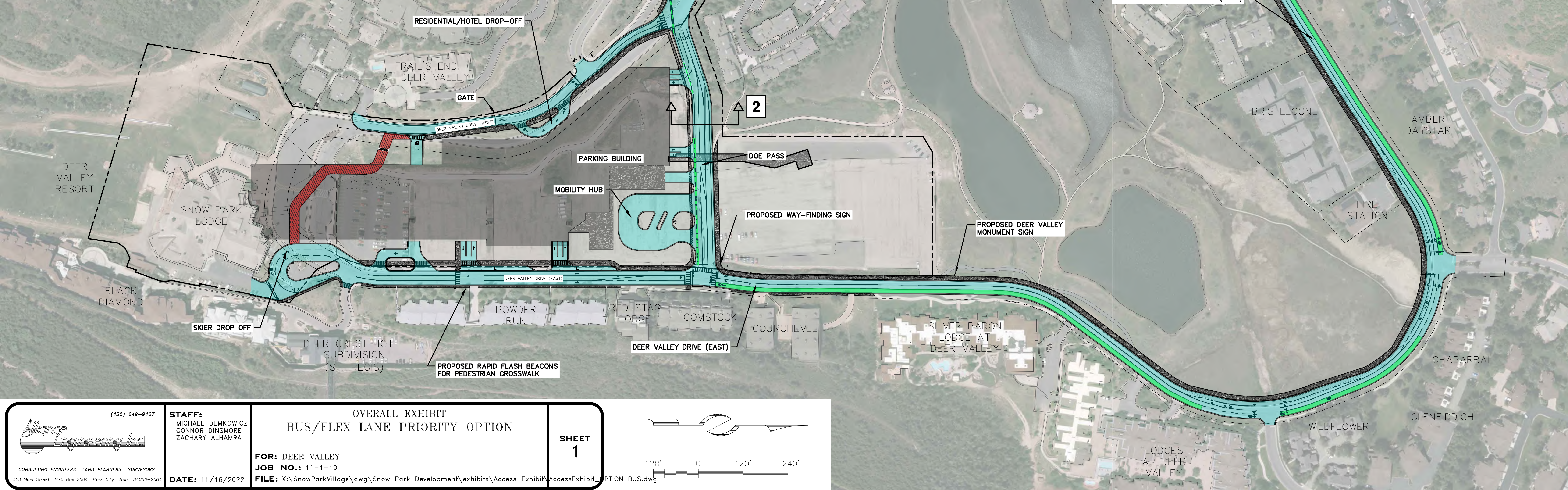
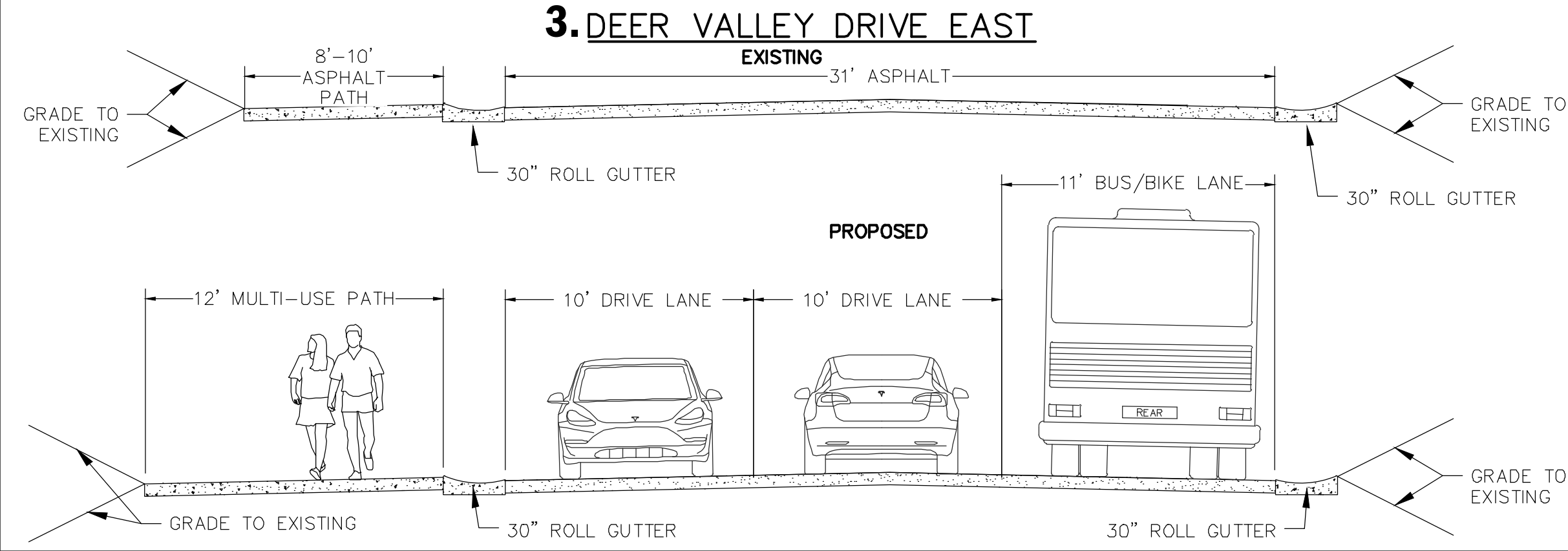
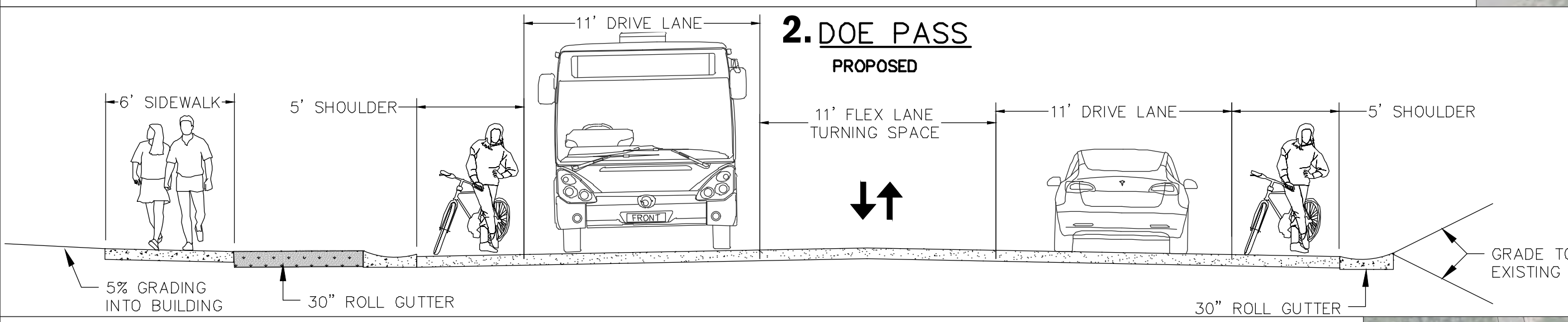
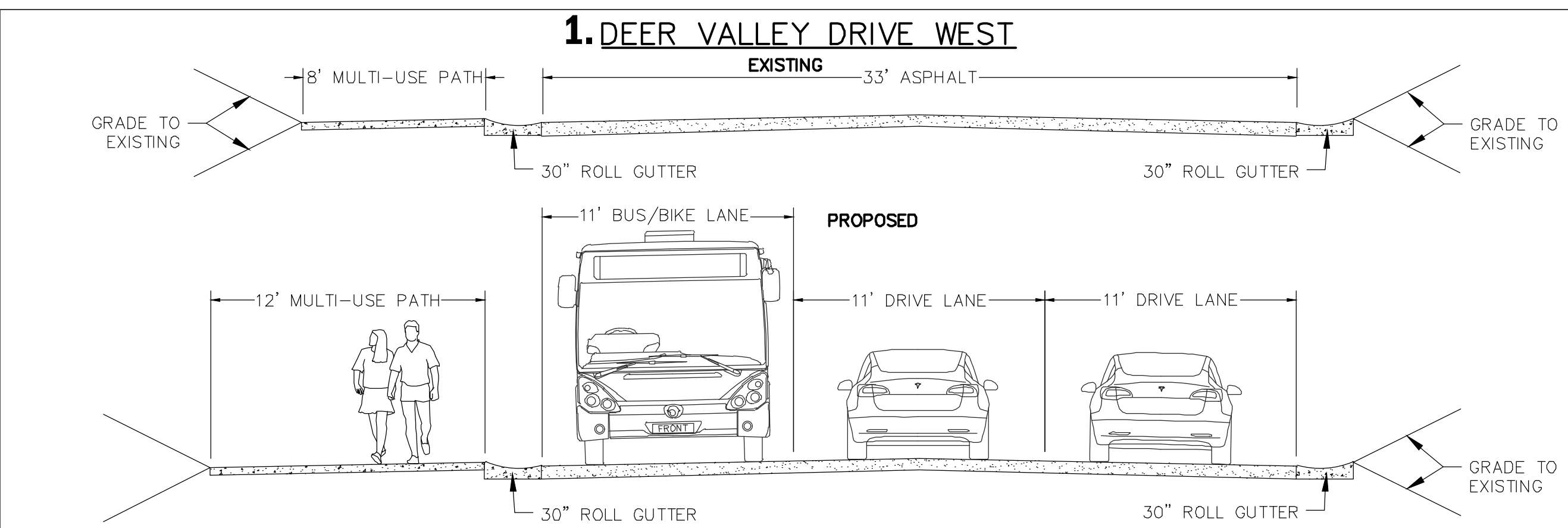

**Alliance Engineering Inc.**  
 CONSULTING ENGINEERS LAND PLANNERS SURVEYORS  
 323 Main Street P.O. Box 2664 Park City, Utah 84060-2664  
 (435) 649-9467

**STAFF:**  
 MICHAEL DEMKOWICZ  
 CONNOR DINSMORE  
 ZACHARY ALHAMRA

**OVERALL EXHIBIT  
 BUS/FLEX LANE PRIORITY OPTION**

**FOR: DEER VALLEY  
 JOB NO.: 11-1-19**

**DATE: 11/16/2022**

**FILE: X:\SnowParkVillage\dwg\Snow Park Development\exhibits\Access Exhibit\AccessExhibit\_OPTION BUS.dwg**

**SHEET  
 1**

TRAFFIC SIGNAL VIEWS

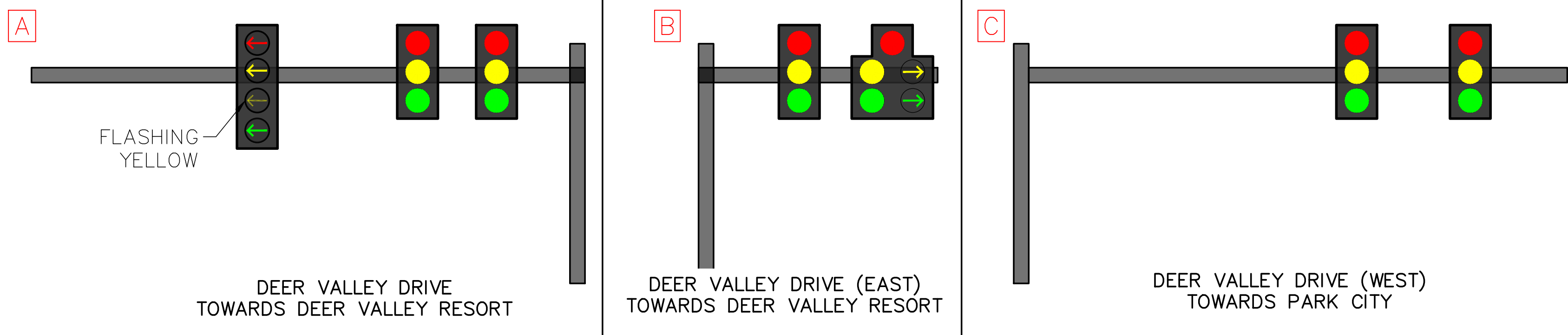

DEER VALLEY DRIVE (WEST) – BRIDGE SECTION

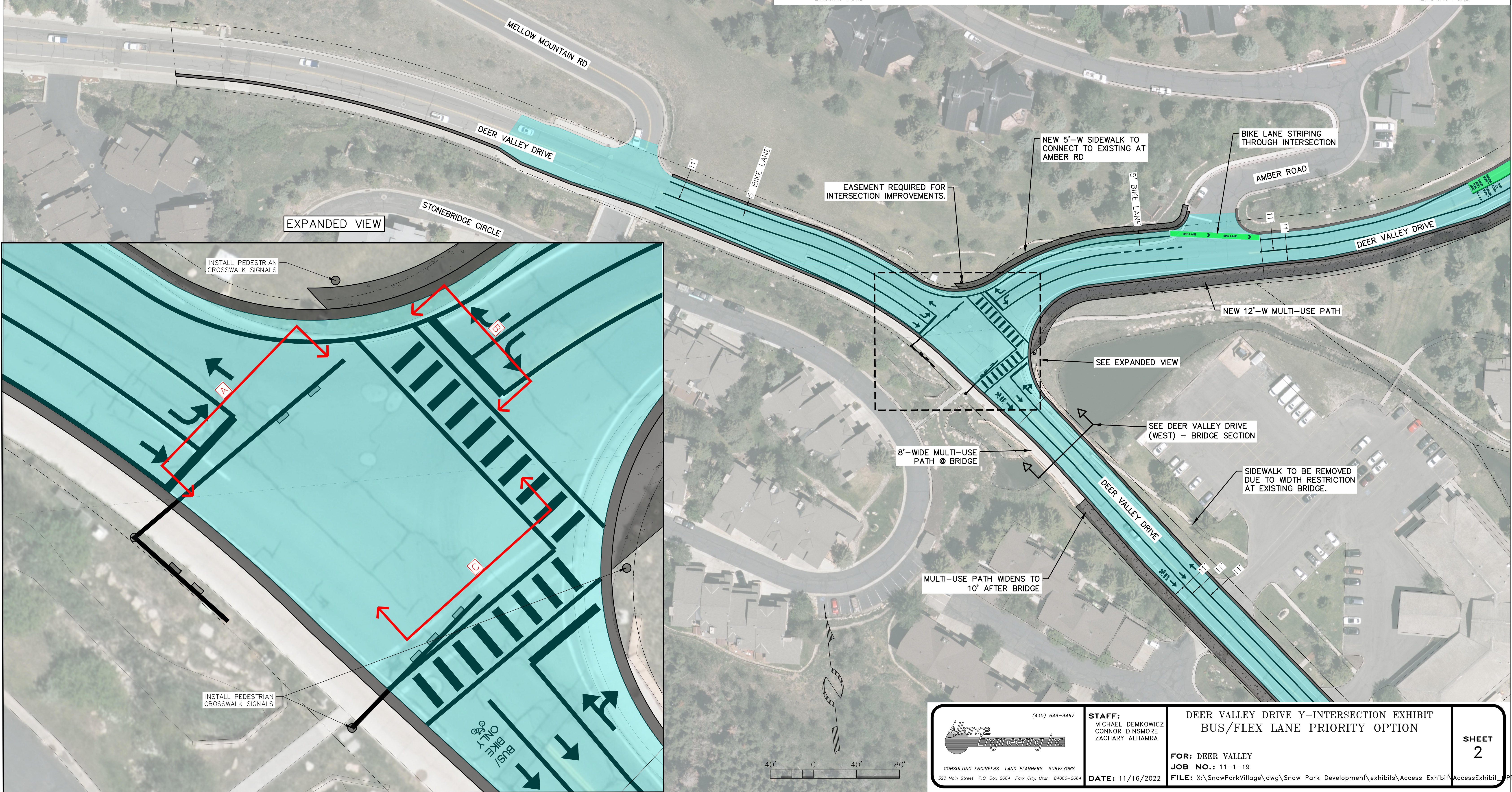
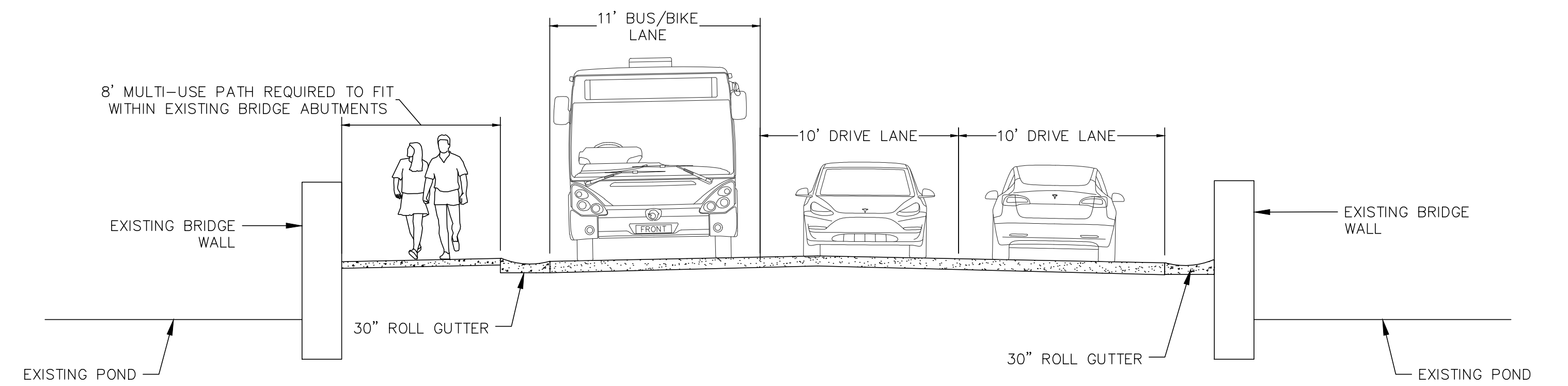

 (435) 649-9467 CONSULTING ENGINEERS LAND PLANNERS SURVEYORS 323 Main Street P.O. Box 2664 Park City, Utah 84060-2664	<b>STAFF:</b> MICHAEL DEMKOWICZ CONNOR DINSMORE ZACHARY ALHAMRA	<b>DEER VALLEY DRIVE Y-INTERSECTION EXHIBIT</b> BUS/FLEX LANE PRIORITY OPTION	SHEET <b>2</b>
	DATE: 11/16/2022	<b>FOR: DEER VALLEY</b> <b>JOB NO.:</b> 11-1-19 <b>FILE:</b> X:\SnowParkVillage\dwg\Snow Park Development\exhibits\Access Exhibit\AccessExhibit_OPTION B	

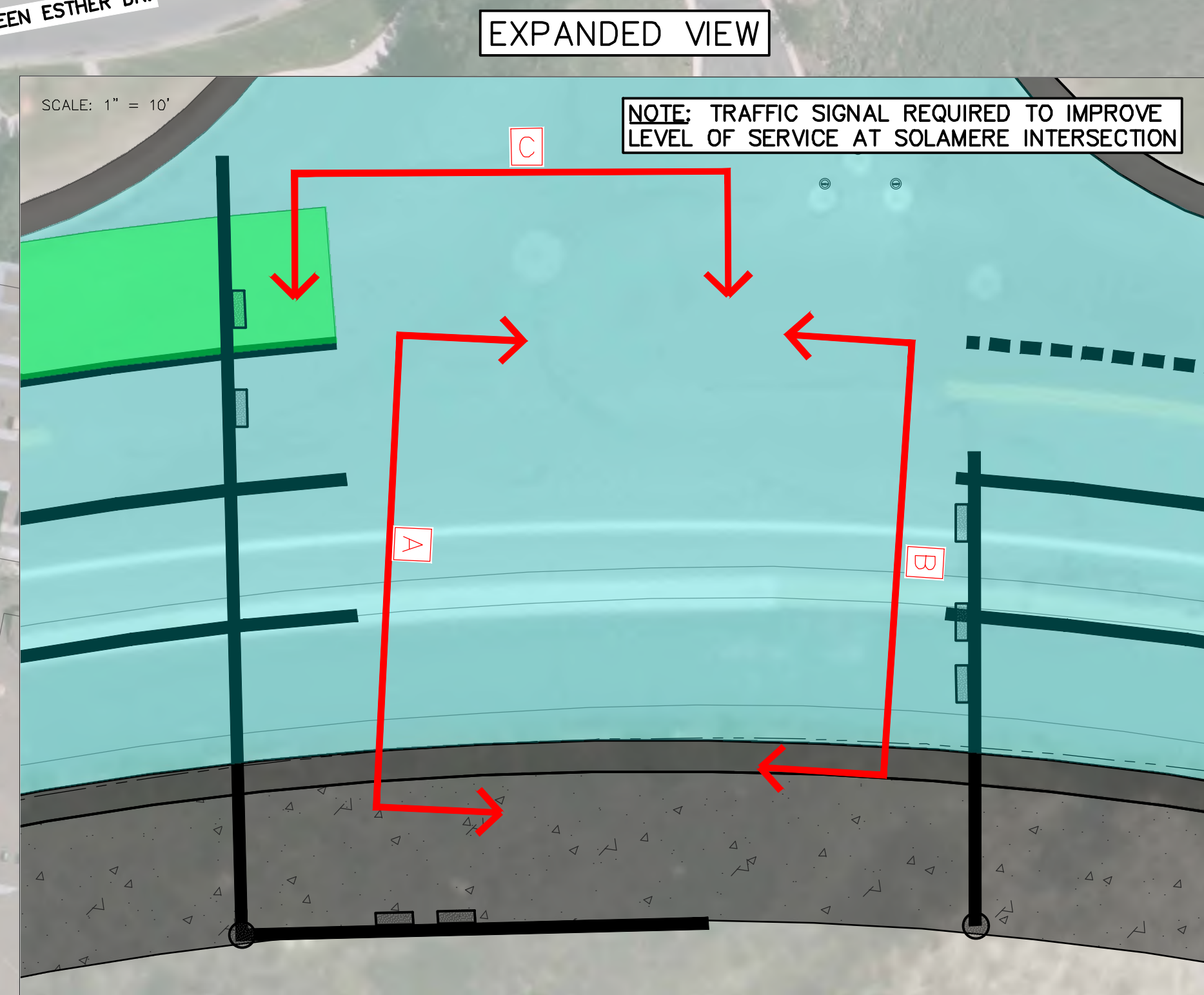
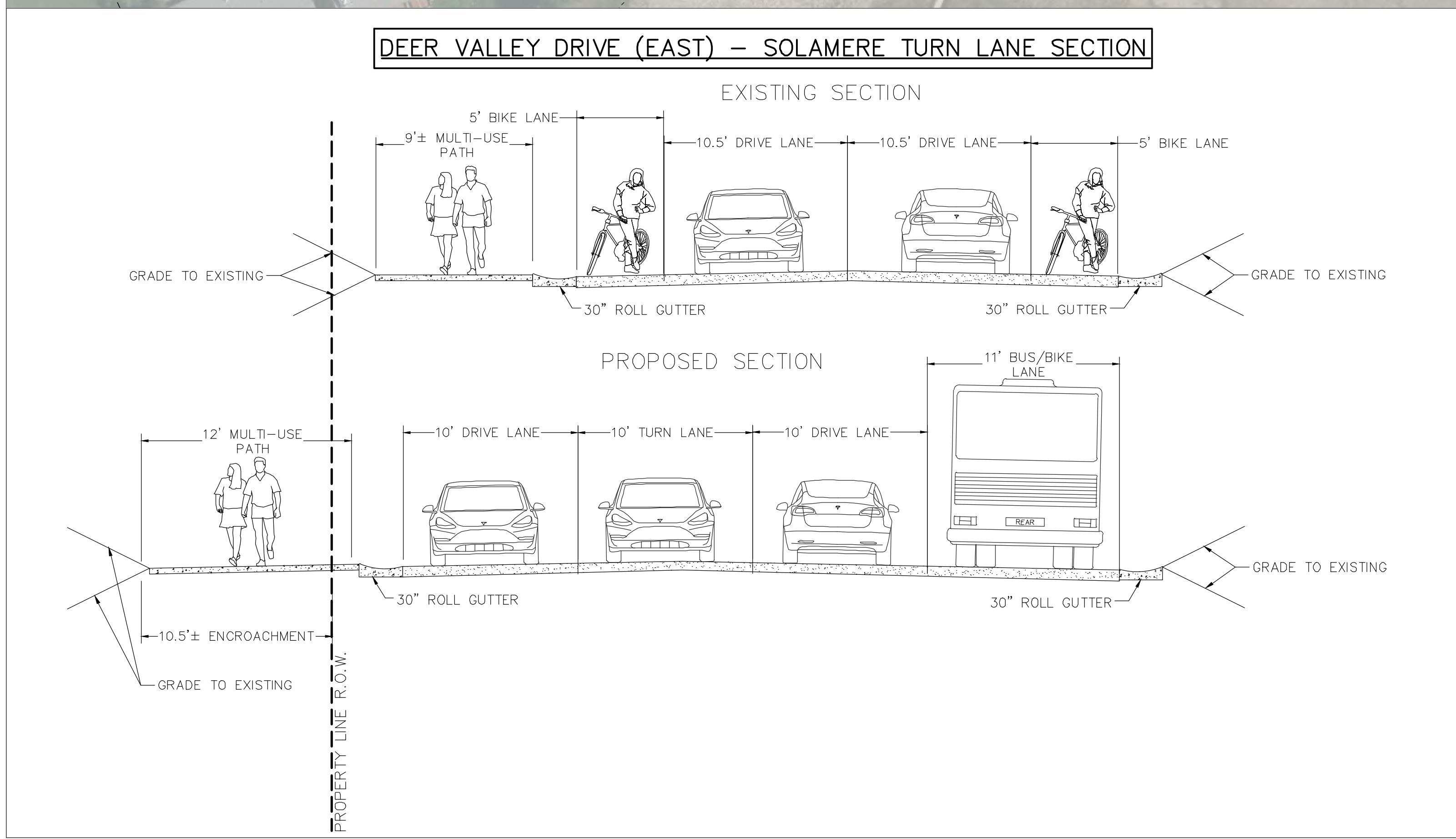
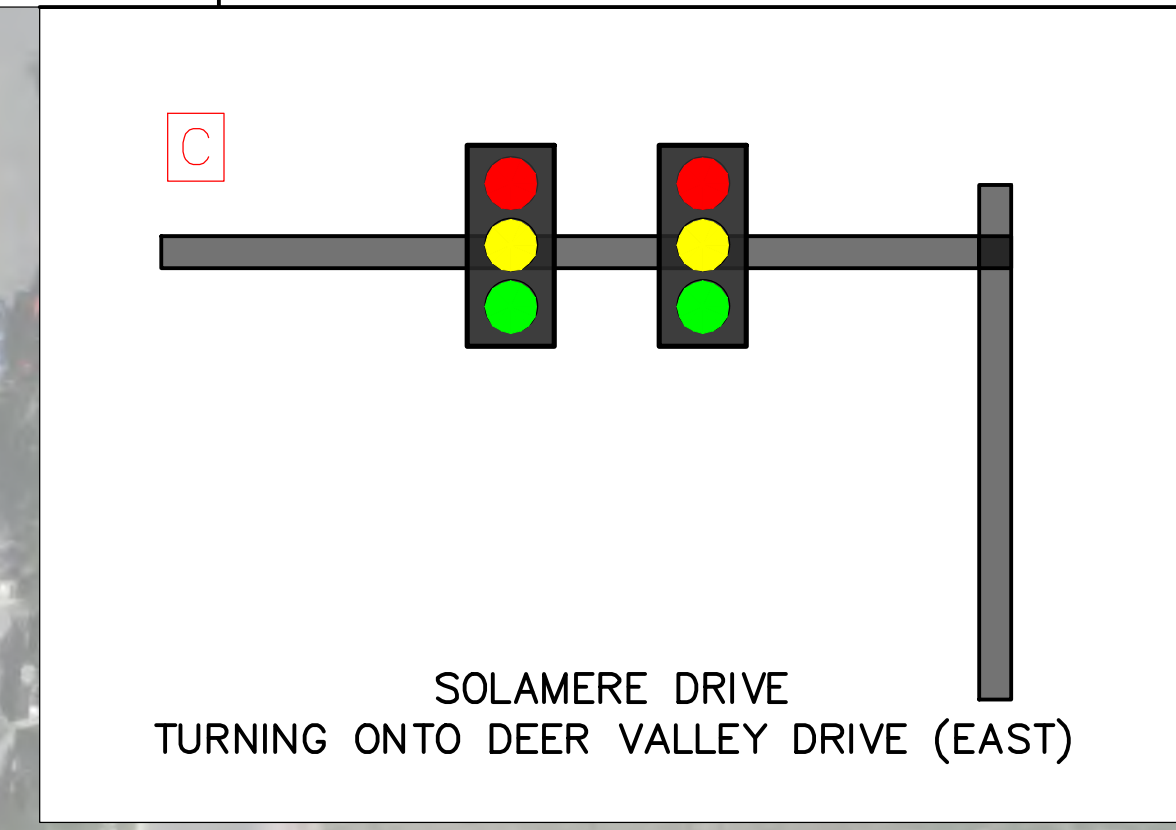
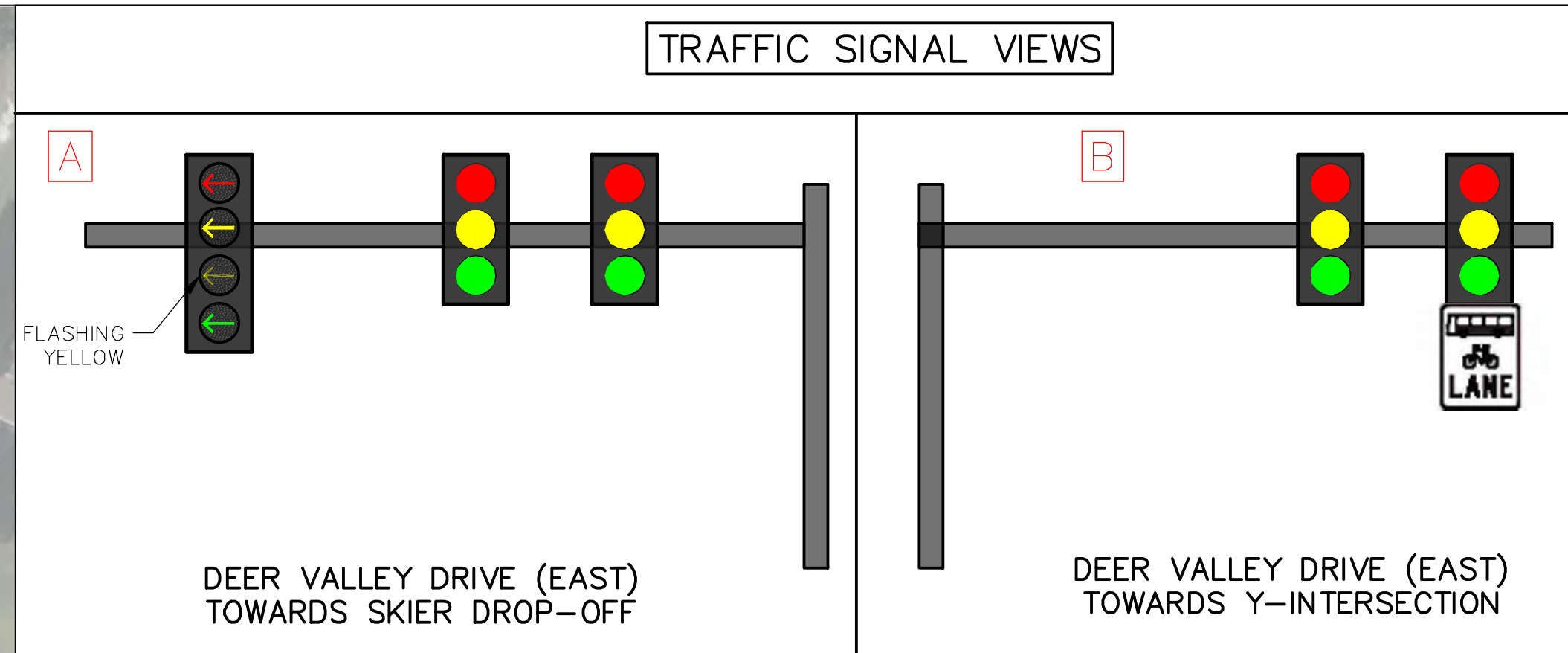
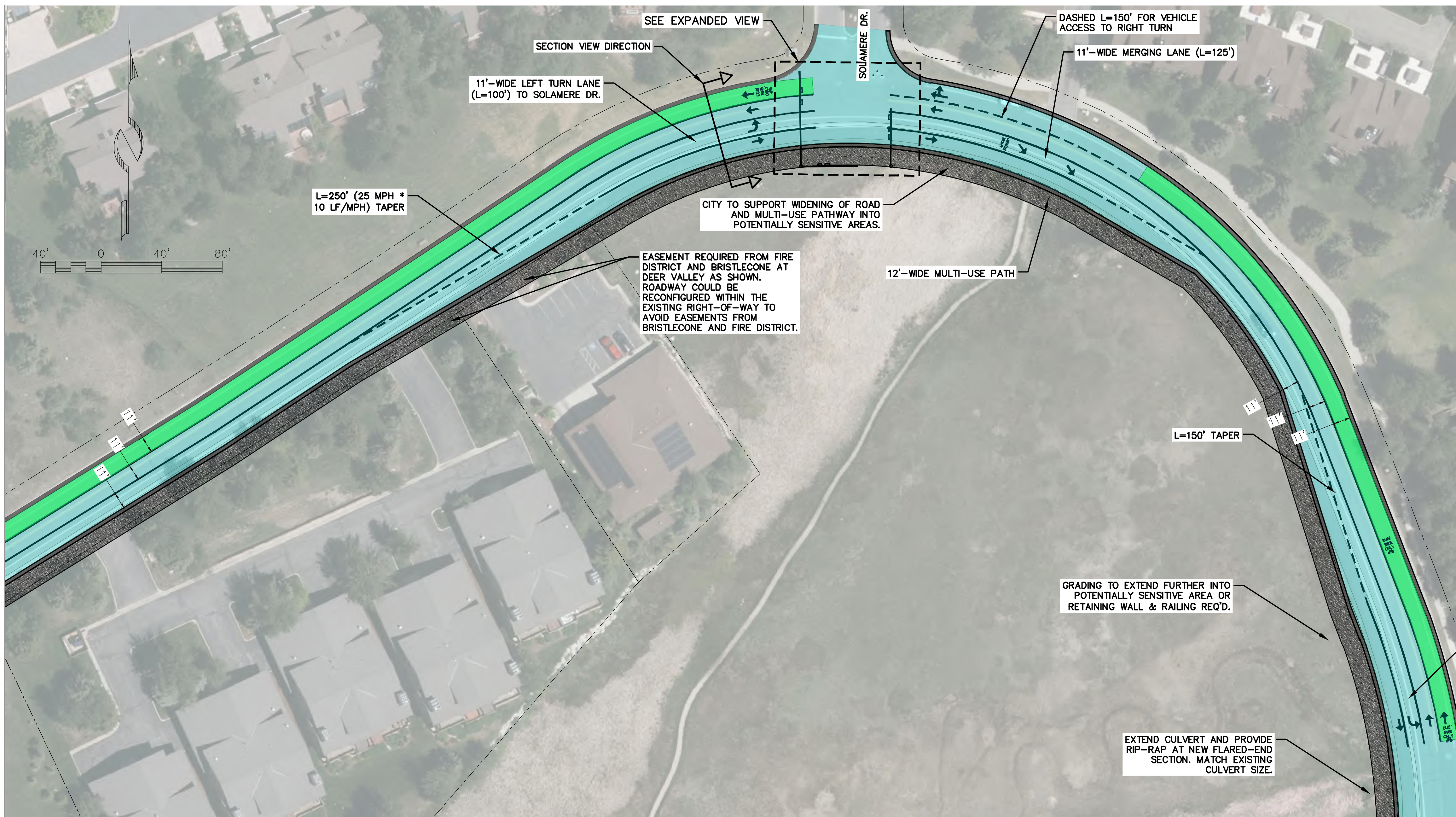

<p>CONSULTING ENGINEERS LAND PLANNERS SURVEYORS</p> <p>323 Main Street P.O. Box 2664 Park City, Utah 84060-2664</p>	<p>(435) 649-9467</p> <p><b>STAFF:</b> MICHAEL DEMKOWICZ CONNOR DINSMORE ZACHARY ALHAMRA</p>	<p>SOLAMERE DR &amp; QUEEN ESTHER DR. EXHIBIT BUS/FLEX LANE PRIORITY OPTION</p>	<p><b>SHEET</b> 3</p>
	<p><b>FOR:</b> DEER VALLEY <b>JOB NO.:</b> 11-1-19 <b>DATE:</b> 11/16/2022</p>	<p><b>FILE:</b> X:\SnowParkVillage\dwg\Snow Park Development\exhibits\Access Exhibit\AccessExhibit_OPTION B</p>	

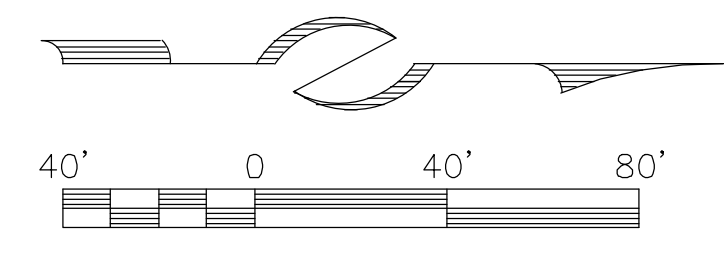
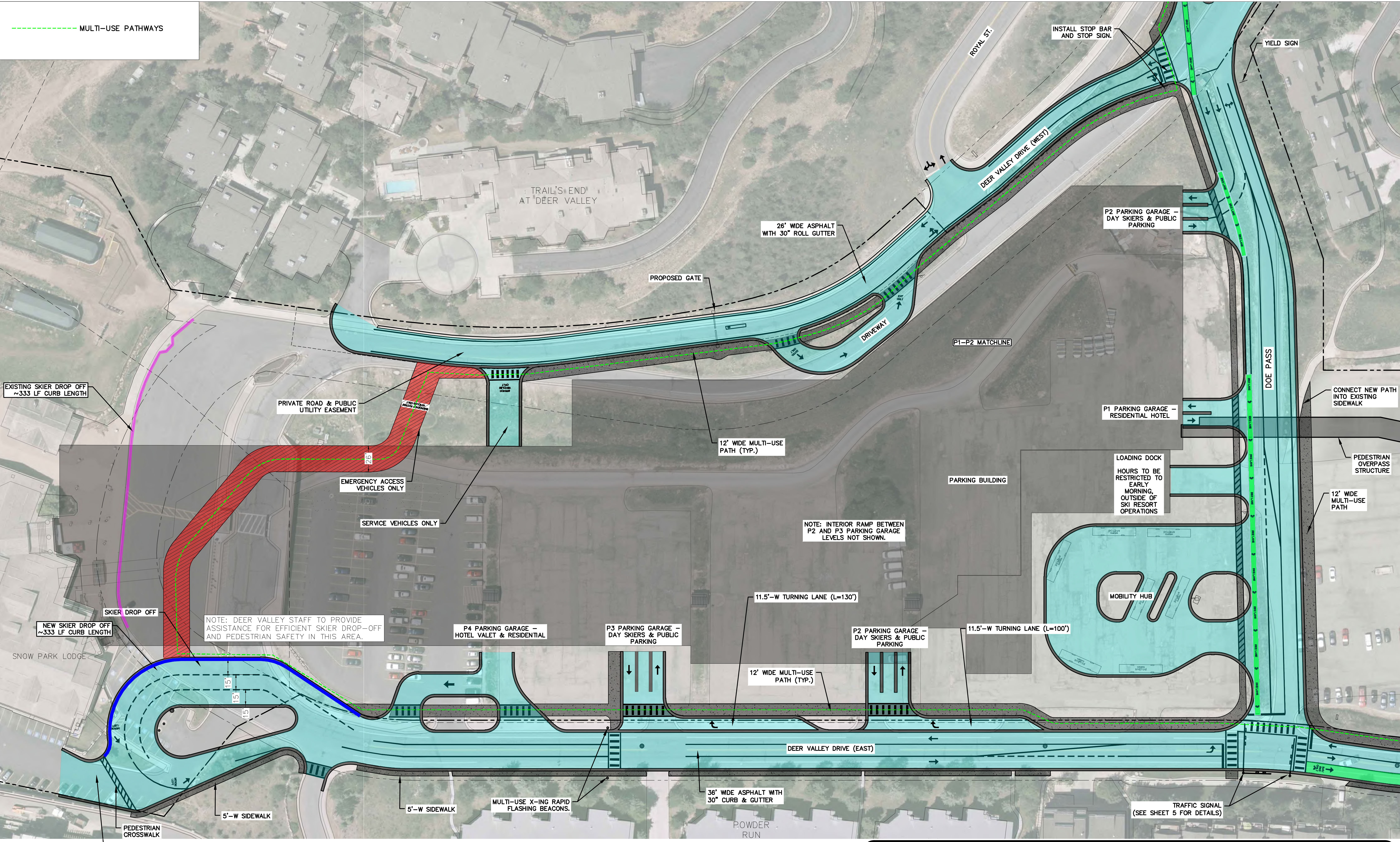

(435) 649-9467  
**Alliance Engineering Inc.**  
 CONSULTING ENGINEERS LAND PLANNERS SURVEYORS  
 323 Main Street P.O. Box 2664 Park City, Utah 84060-2664

**STAFF:**  
 MICHAEL DEMKOWICZ  
 CONNOR DINSMORE  
 ZACHARY ALHAMRA  
**DATE:** 11/16/2022

**OVERALL PARKING GARAGE EXHIBIT  
 BUS/FLEX LANE PRIORITY OPTION**  
**FOR:** DEER VALLEY  
**JOB NO.:** 11-1-19  
**FILE:** X:\SnowParkVillage\dwg\Snow Park Development\exhibits\Access Exhibit\AccessExhibit\_OPTION B

**SHEET  
 4**

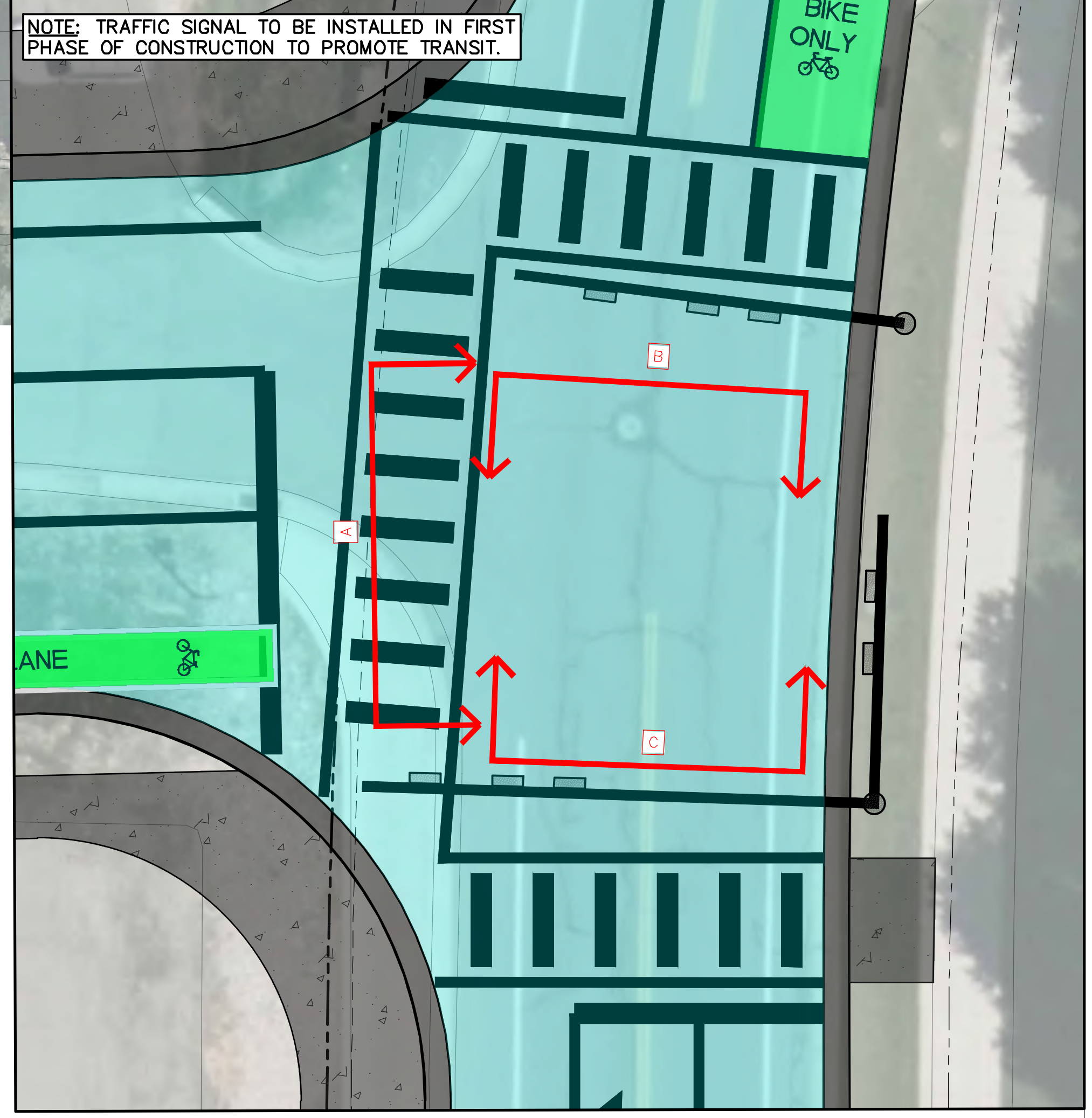
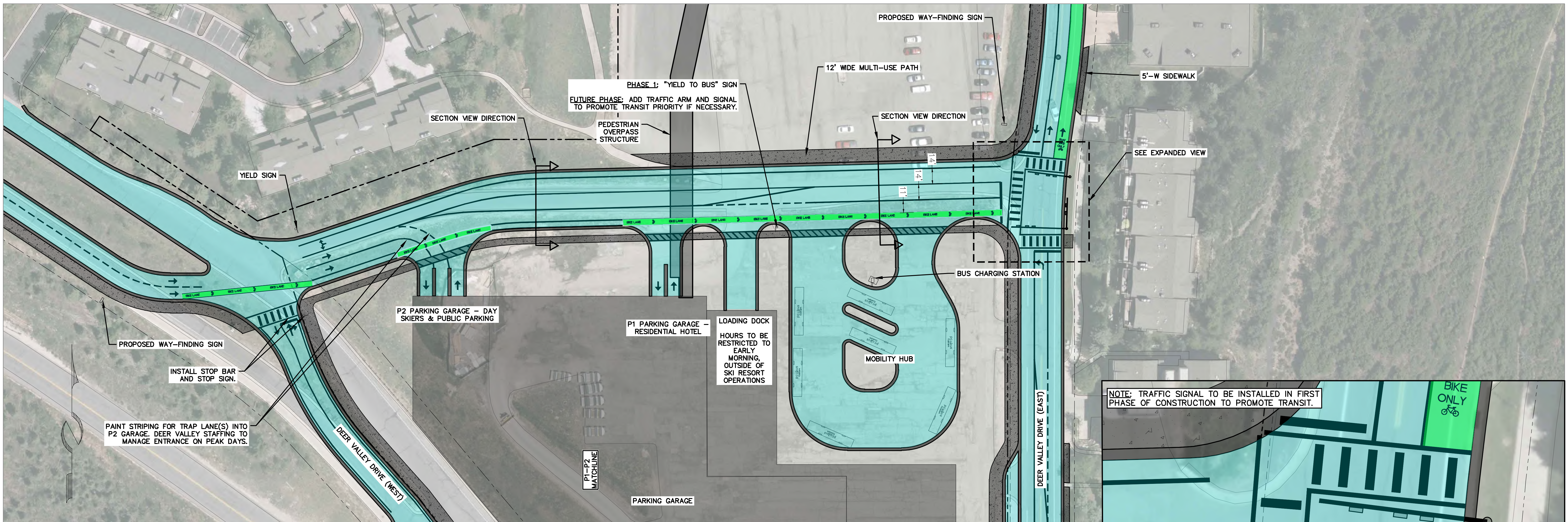

**TRAFFIC SIGNAL VIEWS**

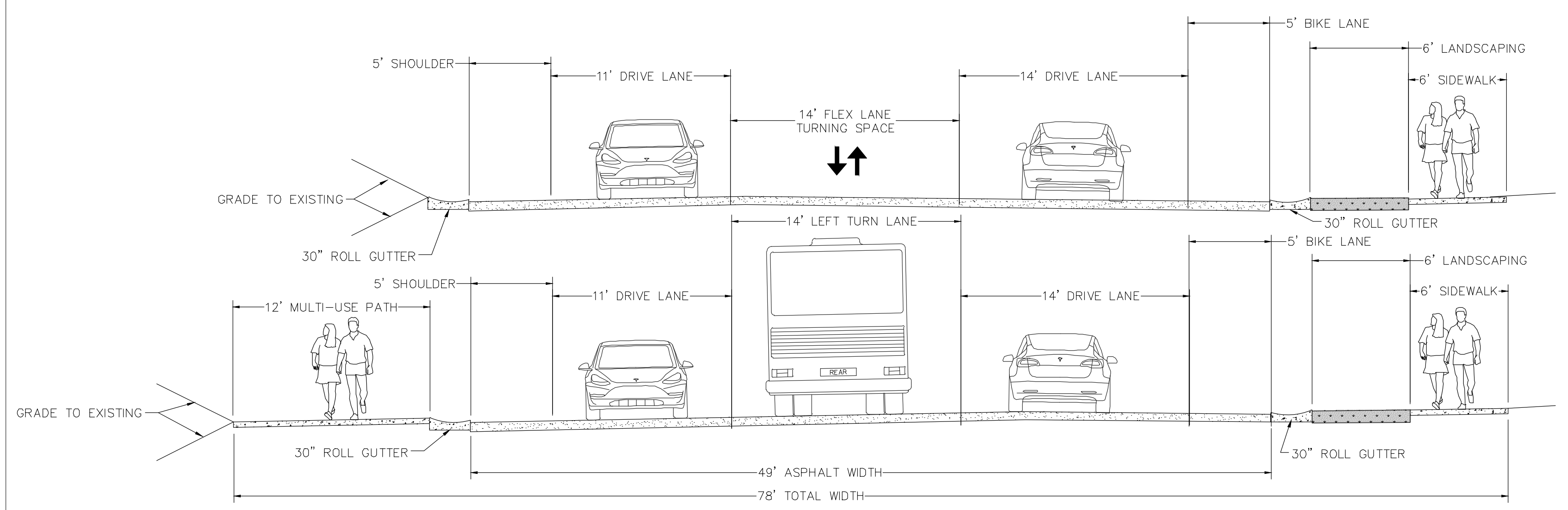
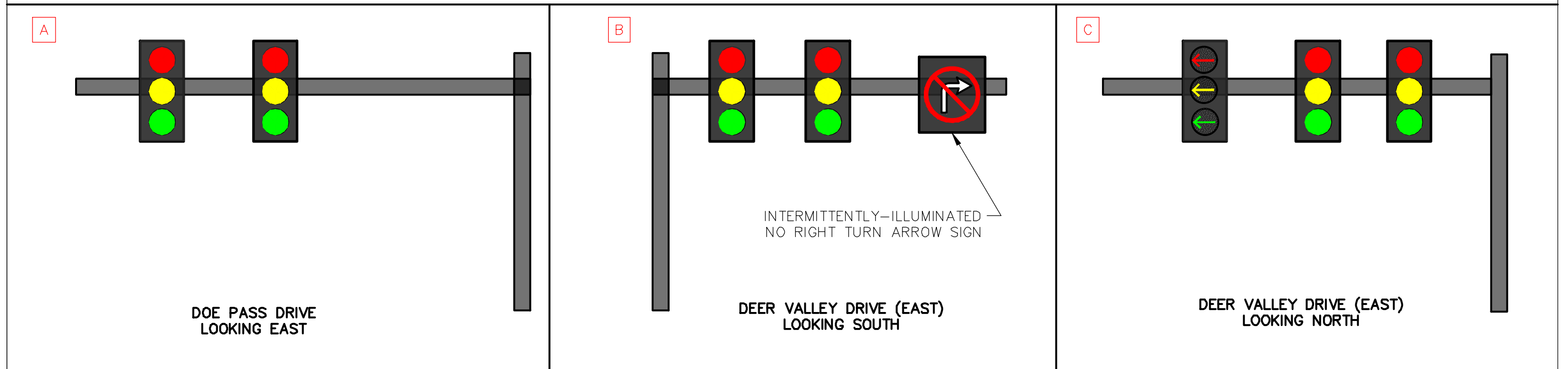

**EXPANDED VIEW**



<p>(435) 649-9467 CONSULTING ENGINEERS LAND PLANNERS SURVEYORS 323 Main Street P.O. Box 2664 Park City, Utah 84060-2664</p>	<p><b>STAFF:</b> MICHAEL DEMKOWICZ CONNOR DINSMORE ZACHARY ALHAMRA</p>	<p><b>DOE PASS ROAD EXHIBIT BUS/FLEX LANE PRIORITY OPTION</b></p>	<p><b>SHEET 5</b></p>
	<p><b>DATE:</b> 11/16/2022</p>	<p><b>FOR:</b> DEER VALLEY <b>JOB NO.:</b> 11-1-19 <b>FILE:</b> X:\SnowParkVillage\dwg\Snow Park Development\exhibits\Access Exhibit\AccessExhibit_OPTION B</p>	

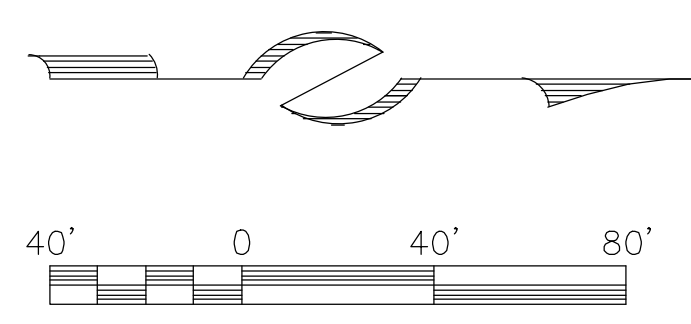
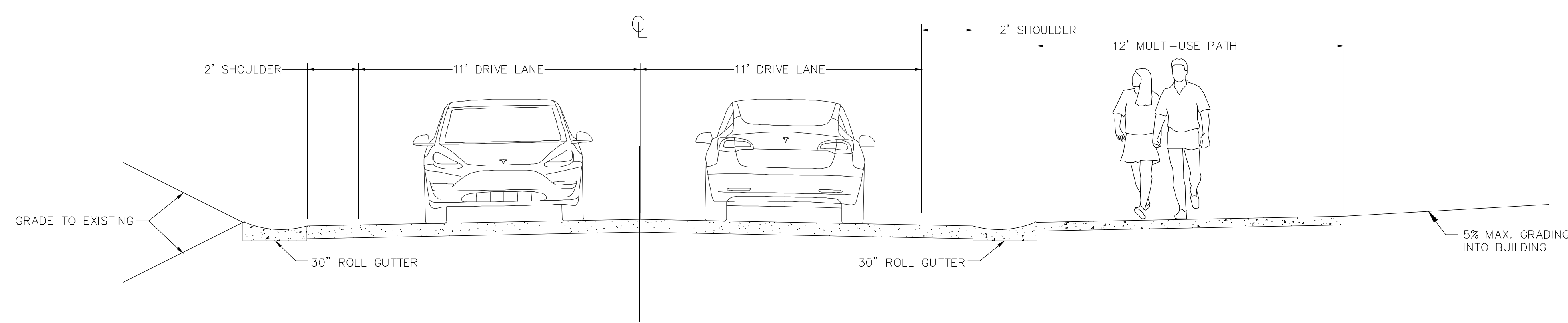
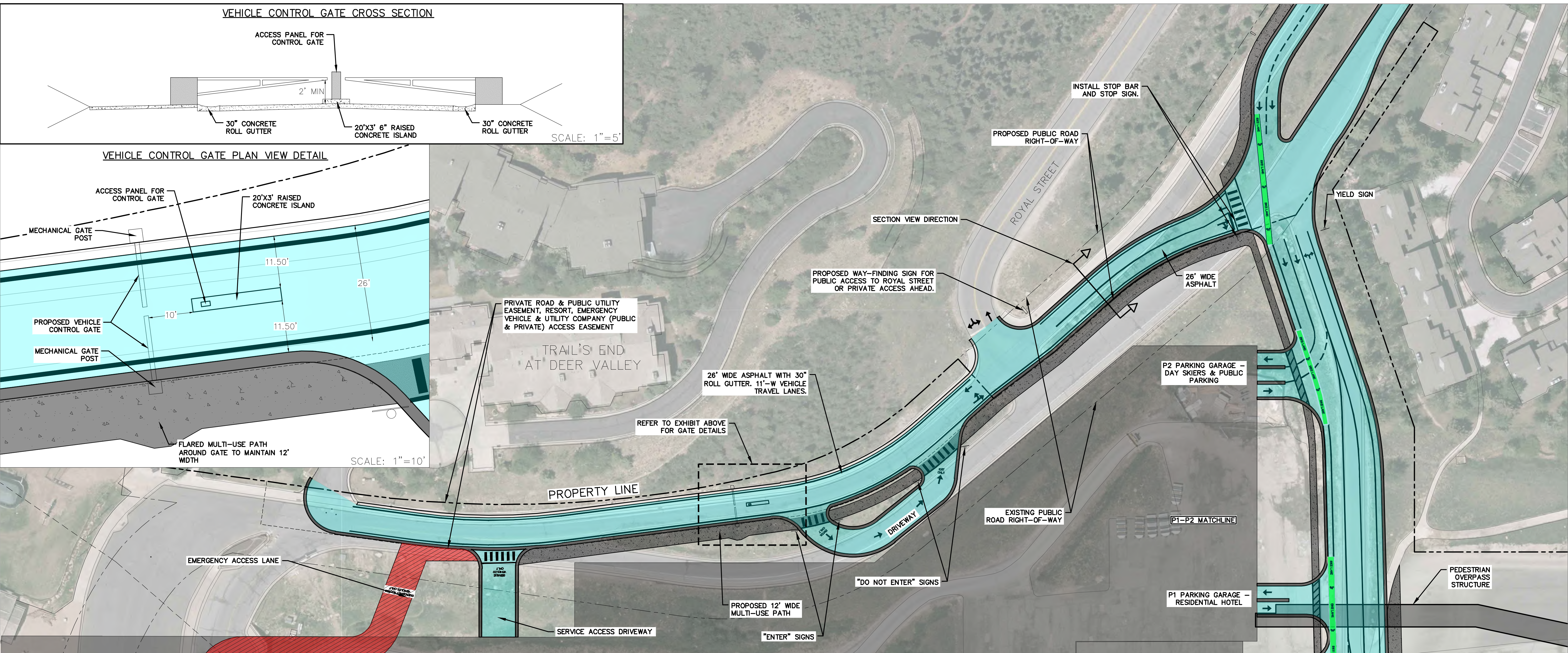
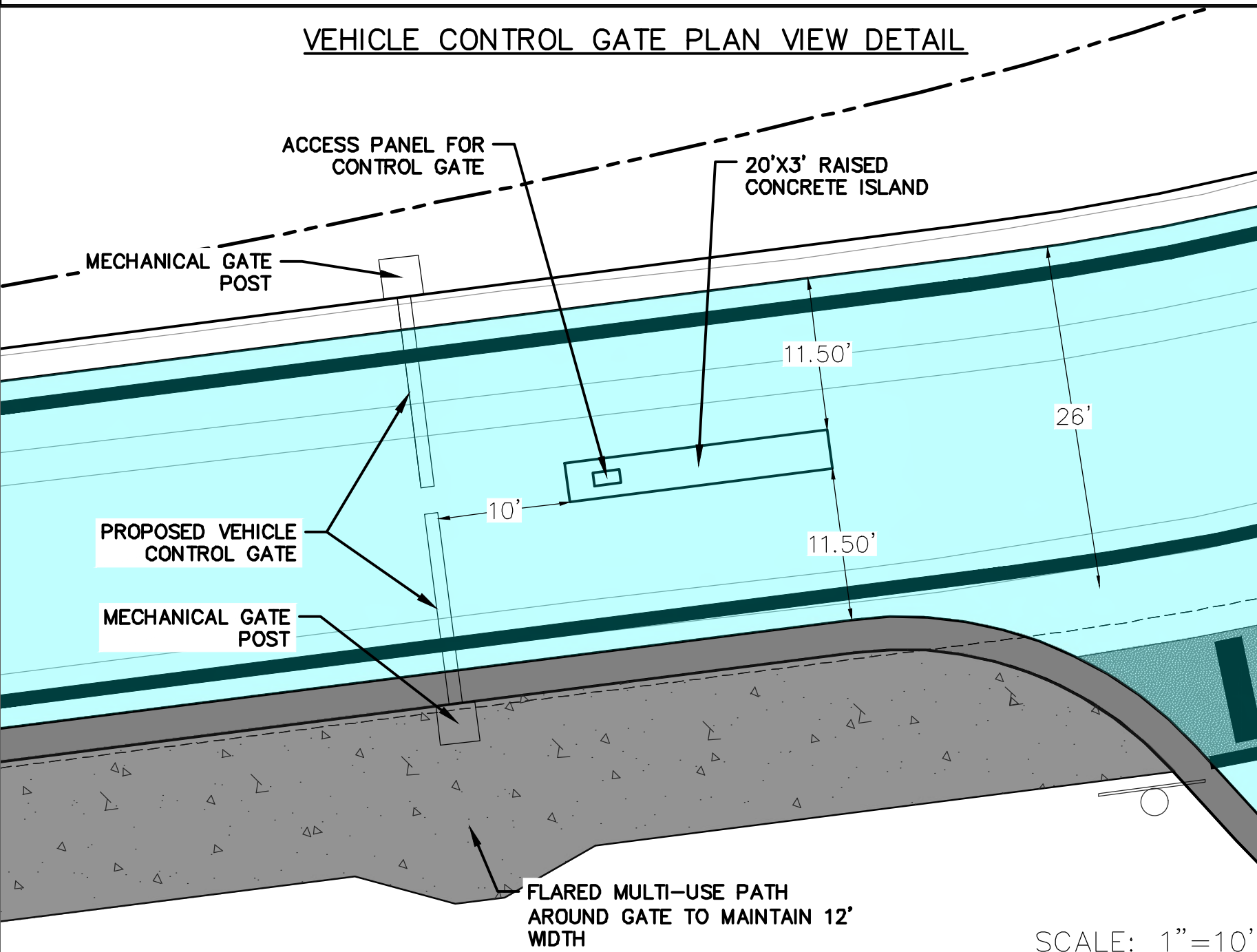
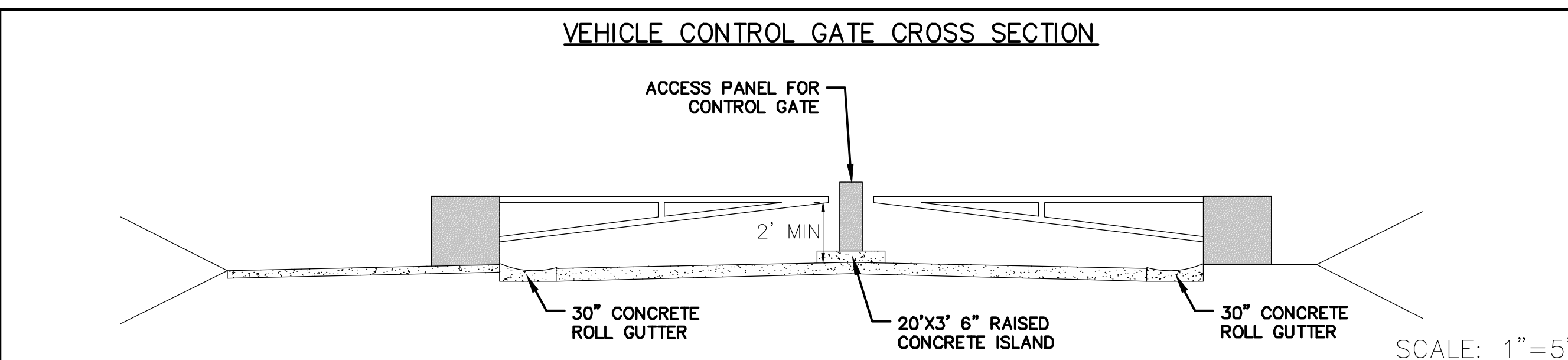

 (435) 649-9467 CONSULTING ENGINEERS LAND PLANNERS SURVEYORS 323 Main Street P.O. Box 2664 Park City, Utah 84060-2664	<b>STAFF:</b> MICHAEL DEMKOWICZ CONNOR DINSMORE ZACHARY ALHAMRA	<b>DEER VALLEY DRIVE WEST EXHIBIT</b> <b>BUS/FLEX LANE PRIORITY OPTION</b>	<b>SHEET</b> <b>6</b>
	<b>DATE:</b> 11/16/2022	<b>FOR:</b> DEER VALLEY <b>JOB NO.:</b> 11-1-19 <b>FILE:</b> X:\SnowParkVillage\dwg\Snow Park Development\exhibits\Access Exhibit\AccessExhibit_PTION B	