

# **Snow Park Village Transportation Analysis**

**Prepared for:  
Deer Valley**

July 2022

UT20-2245

**FEHR  PEERS**

# Table of Contents

---

<b>1. Executive Summary</b> .....	<b>1</b>
1.1.1 Study Results.....	2
1.1.2 LOS Summary.....	3
1.1.3 Proposed Mitigations.....	4
1.1.4 Conclusion / Recommendations.....	5
<b>2. Introduction</b> .....	<b>6</b>
2.1 Scope.....	7
2.2 Analysis Methodology.....	10
<b>3. Existing (2020) Background Conditions</b> .....	<b>12</b>
3.1 Roadway System.....	12
3.2 Traffic Volumes.....	13
3.3 Level of Service Analysis.....	17
3.4 Mitigation Measures.....	18
3.5 Origin-Destination Data.....	18
3.6 Vehicle Occupancy Data.....	19
<b>4. Project Conditions</b> .....	<b>23</b>
4.1 Project Description.....	23
4.1.1 Site Access and Circulation.....	23
4.2 Trip Generation.....	26
4.3 Trip Distribution and Assignment.....	31
<b>5. Existing 2020 plus Project Conditions</b> .....	<b>33</b>
5.1 Traffic Volumes.....	33
5.2 Level of Service Analysis.....	35
5.3 Mitigation Measures.....	36
<b>6. Opening Year (2024) Background Conditions</b> .....	<b>40</b>
6.1 Traffic Volumes.....	40
6.2 Level of Service Analysis.....	40
6.3 Mitigation Measures.....	42
<b>7. Opening Year (2024) Plus Project Conditions</b> .....	<b>44</b>
7.1 Traffic Volumes.....	44
7.2 Level of Service Analysis.....	45
7.3 Mitigation Measures.....	46
<b>8. Future 2040 Background Conditions</b> .....	<b>50</b>
8.1 Traffic Volumes.....	50

8.2 Level of Service Analysis .....	50
8.3 Mitigation Measures .....	52
<b>9. Future 2040 plus Project Conditions .....</b>	<b>54</b>
9.1 Purpose .....	54
9.2 Traffic Volumes .....	54
9.3 Level of Service Analysis .....	54
9.4 Mitigation Measures .....	56
<b>10. Roadway Analysis.....</b>	<b>60</b>
10.1 Analysis Results .....	60
<b>11. Site Circulation Analysis.....</b>	<b>62</b>
11.1.1 Conditions and Assumptions.....	62
11.1.2 Analysis Results .....	63
<b>13. Parking Analysis .....</b>	<b>74</b>
13.1 Analysis Method .....	74
13.2 Parking Management .....	76
<b>14. Transit Evaluation .....</b>	<b>77</b>
14.1.1 Existing Transit Service.....	77
14.2 Proposed Transit Improvements .....	77
<b>15. Transportation Demand Management .....</b>	<b>79</b>
15.1 TDM Monitoring .....	80
<b>16. Conclusion/Recommendations .....</b>	<b>81</b>
<b>Appendix.....</b>	<b>82</b>

## List of Figures

---

Figure 1: Project Location .....	8
Figure 2: Study Intersections .....	9
Figure 3: Existing 2020 Background Saturday AM & PM Peak Hour Traffic Conditions .....	16
Figure 4: Deer Valley Origin-Destination AM Incoming – PM Outgoing Trends .....	22
Figure 5: Conceptual Site Plan.....	25
Figure 6: Saturday AM & PM Peak Hour Trip Generation and Distribution .....	32
Figure 7: Existing 2020 plus Project Saturday AM & PM Peak Hour Traffic Conditions.....	34
Figure 8: Proposed Reconfiguration of Deer Valley Drive / Deer Valley Drive East / Deer Valley Drive West Intersection.....	38
Figure 9: Opening Year 2024 Background Saturday AM & PM Peak Hour Traffic Conditions.....	43
Figure 10: Opening Year 2024 plus Project Saturday AM & PM Peak Hour Traffic Conditions.....	49
Figure 11: Future 2040 Background Saturday AM & PM Peak Hour Traffic Conditions.....	53
Figure 12: Future 2040 plus Project Saturday AM & PM Peak Hour Traffic Conditions .....	59
Figure 13: 2040 Site Circulation Analysis Intersection LOS Results.....	68
Figure 14: 2040 Site Circulation Analysis Intersection Queue Results.....	73

## List of Tables

---

Table 1: Snow Park Village Saturday AM and PM Peak Hour Level of Service Summary .....	3
Table 2: Proposed Mitigations for Snow Park Village-Generated Traffic Impacts.....	4
Table 3: Level of Service Descriptions .....	11
Table 4: Existing 2020 Background Conditions Saturday AM & PM Peak Hour Level of Service.....	17
Table 5: Snow Park Village Vehicle Occupancy Summary.....	21
Table 6: Snow Park Village Trip Generation .....	30
Table 7: Existing 2020 plus Project Conditions Saturday AM & PM Peak Hour Level of Service .....	35
Table 8: Existing 2020 plus Project Mitigated Conditions Saturday AM & PM Peak Hour Level of Service .....	39
Table 9: Opening Year 2024 Background Conditions Saturday AM & PM Peak Hour Level of Service .....	41
Table 10: Opening Year 2024 plus Project Conditions Saturday AM & PM Peak Hour Level of Service .....	45
Table 11: Opening Year 2024 plus Project Mitigated Conditions Saturday AM & PM Peak Hour Level of Service .....	48
Table 12: Future 2040 Background Conditions Saturday AM & PM Peak Hour Level of Service .....	51
Table 13: Future 2040 plus Project Conditions Saturday AM & PM Peak Hour Level of Service.....	55
Table 14: Future 2040 plus Project Mitigated Conditions Saturday AM & PM Peak Hour Level of Service .....	58
Table 15: Roadway Level of Service Peak Hour Two-Way Traffic Thresholds .....	60
Table 16: Snow Park Village Roadway LOS Analysis Summary .....	61



Table 17: Future 2040 Plus Project Conditions Saturday AM & PM Peak Hour Level of Service Site Circulation Results .....	64
Table 18: Future 2040 Plus Project Conditions AM & PM Peak Hour Level of Service Site Circulation Results – Weekday Sensitivity .....	67
Table 19: Future 2040 Plus Project Conditions Saturday AM & PM Peak Hour Queues Site Circulation Analysis .....	70
Table 20: Snow Park Village Parking Analysis Summary .....	76
Table 21: Deer Valley TDM Measures .....	79

*This page intentionally left blank.*

# 1. Executive Summary

This Traffic Impact Study includes the results of a comprehensive traffic operations analysis for the Snow Park Village project at Deer Valley Resort in Park City, Utah. Snow Park Village is a mixed-use development that will serve as an updated base area village for Deer Valley, and includes hotel, residential, commercial, and event center uses.

The scope of this study analyzes the traffic operations and impacts under the following scenarios:

- Existing (2020) Conditions
- Existing (2020) Plus Project Conditions
- Opening Year (2024) Background Conditions
- Opening Year (2024) Plus Project Conditions
- Future (2040) Background Conditions
- Future (2040) Plus Project Conditions

Existing conditions were based on the traffic counts, which were collected originally in 2020. As this process has continued, Park City Staff have accepted that 2020 counts continue to serve as the foundation for this report with adjustments made for assumed marginal increases in traffic on an annual basis.

Traffic operations for these scenarios were analyzed at nine study intersections:

1. Doe Pass Road / Deer Valley Drive East
2. Doe Pass Road / Deer Valley Drive West
3. Deer Valley Drive East / Queen Esther Drive
4. Deer Valley Drive East / Solamere Drive
5. Deer Valley Drive / Deer Valley Drive East / Deer Valley Drive West
6. Deer Valley Drive / Marsac Avenue
7. Deer Valley Drive / Bonanza Drive
8. Deer Valley Drive / Park Avenue / Empire Avenue
9. Bonanza Drive / Monitor Drive / SR-248

Study intersections 5 and 8 currently operate at Levels of Service (LOS) that do not meet Part City standards, which is LOS C. However, these intersections were analyzed as part of this study to identify Deer Valley's contributions to traffic at key intersections within Park City in support of Park City Municipal Corporation's (PCMC) goals of reducing peak-hour traffic volumes by 20% citywide.



The Plus Project traffic operations analyses include trips generated by the Snow Park Village project. The parking analysis accounts for both physical (structured) and behavioral impacts of the identified resort uses, as well as parking pricing. To present conservative, and thereby overestimated, results in this report, reductions in trip generation and parking demand stemming from proposed enhancements to local transit service, operated by Park City Transit and/or High Valley Transit, or Deer Valley's existing Transportation Demand Management (TDM) program are not included.

### **1.1.1 Study Results**

In Plus project Conditions, four of nine study intersections, with recommended mitigations in place, meet the Park City LOS standards. Under existing conditions, the intersection of Deer Valley Drive / Park Avenue / Empire Avenue operates at a LOS of E/F. Given the City's longstanding position on additional mitigations at this intersection, none are recommended. Deer Valley Drive in this area is also SR-224, and therefore managed by the Utah Department of Transportation (UDOT). This includes intersection operations. The deficiencies at the Deer Valley Drive / Bonanza Drive intersection are caused by the queue spillbacks from the upstream intersection at Deer Valley Drive / Park Avenue / Empire Avenue. Therefore, no mitigations are recommended.

Furthermore, the most impaired intersection under current conditions, the Deer Valley Drive / Deer Valley Drive East / Deer Valley Drive West intersection, which operates today at a LOS below Park City standards, achieves a LOS of D under 2040 Plus Project conditions by reconfiguring the intersection, establishing a new access pattern for some day skiers. For the Queen Esther Drive / Deer Valley Drive East and Solamere Drive / Deer Valley Drive East intersections, it is recommended that the traffic be monitored and determine if further traffic control is needed when warranted to improve traffic flow and safety, but no further mitigations are recommended at this time.

Parking provided as part of the Snow Park Village Proposal will be provided at levels roughly 20% lower than required by code. Reduced parking demand will be achieved through the implementation of a paid parking system, and continued operation and refinement of Deer Valley's Transportation Demand Management program by supporting non-single-occupancy vehicle trips while also actively discouraging driving alone, and through time-of-day sharing of parking for different and complementary uses.

In alignment with Park City's *Transit First* strategy, construction of Snow Park Village will prioritize active transportation and transit as modes for travel to, from, and within the village. To that end, Deer Valley will construct an on-site mobility hub with space for six buses which will be connected to the broader Park City and High Valley Transit networks. One new traffic signal is recommended, at the intersection of Doe Pass



Road / Deer Valley Drive East as a mitigation which will include transit signal preemption capabilities to expedite transit service into and out of proposed the mobility hub. Additionally, off-street multiuse paths will be constructed to connect Snow Park to Park City’s existing active transportation network.

## 1.1.2 LOS Summary

**Table 1** reports LOS at the study intersections. For signalized intersections and roundabouts, average vehicular delay and LOS are reported. For unsignalized intersections, the worst movement delay and LOS are reported. Detailed descriptions of the intersection operations can be found in the subsequent chapters. Due to the land use program proposed for Snow Park Village, the net total trips generated by the AM peak hour is 162 trips and the PM peak hour is 204 trips.

**Table 1: Snow Park Village Saturday AM and PM Peak Hour Level of Service Summary**

Intersection			Existing Background	Existing + Project Mitigated <sup>2</sup>	2024 Background	2024 + Project Mitigated <sup>2</sup>	2040 Background	2040 + Project Mitigated <sup>2</sup>
ID	Location	Period	LOS & Sec/Veh <sup>1</sup>	LOS & Sec/Veh <sup>1</sup>	LOS & Sec/Veh <sup>1</sup>	LOS & Sec/Veh <sup>1</sup>	LOS & Sec/Veh <sup>1</sup>	LOS & Sec/Veh <sup>1</sup>
1	Doe Pass Rd / Deer Valley Dr East	AM	-	2 / A	-	2 / A	-	2 / A
		PM	-	3 / A	-	3 / A	-	4 / A
2	Doe Pass Rd / Deer Valley Dr West	AM	-	6 / A	-	6 / A	-	10 / B
		PM	-	6 / A	-	5 / A	-	6 / A
3	Queen Esther Dr / Deer Valley Dr East	AM	6 / A	10 / B	6 / A	9 / A	7 / A	13 / B
		PM	9 / A	<b>27 / D</b>	8 / A	24 / C	9 / A	<b>54 / F</b>
4	Deer Valley Dr East / Solamere Dr	AM	7 / A	12 / B	6 / A	8 / A	8 / A	15 / C
		PM	11 / B	<b>55 / F</b>	11 / B	<b>49 / E</b>	15 / C	<b>155 / F</b>
5	Deer Valley Dr / Deer Valley Dr East / Deer Valley Dr West	AM	15 / C	13 / B	14 / B	10 / B	17 / C	18 / C
		PM	<b>39 / E</b>	17 / C	<b>41 / E</b>	18 / C	<b>112 / F</b>	<b>31 / D</b>
6	Deer Valley Drive / Marsac Avenue	AM	11 / B	12 / B	11 / B	13 / B	16 / C	20 / C
		PM	11 / B	13 / B	11 / B	14 / B	11 / B	11 / B
7	Deer Valley Dr / Bonanza Dr	AM	11 / B	11 / B	11 / B	12 / B	18 / B	24 / C
		PM	21 / C	30 / C	20 / C	30 / C	<b>59 / E</b>	<b>87 / F</b>
8	Deer Valley Dr / Park Ave / Empire Ave	AM	<b>77 / E</b>	<b>75 / E</b>	<b>82 / F</b>	<b>81 / F</b>	<b>83 / F</b>	<b>83 / F</b>
		PM	<b>84 / F</b>	<b>87 / F</b>	<b>85 / F</b>	<b>86 / F</b>	<b>90 / F</b>	<b>90 / F</b>
9		AM	12 / B	13 / B	13 / B	14 / B	16 / B	15 / B



Bonanza Dr / Monitor Dr / SR-248	PM	20 / C	21 / C	20 / C	22 / C	28 / C	31 / C
-------------------------------------	----	--------	--------	--------	--------	--------	--------

Notes:

**Bold text** indicates intersections operating below Park City's acceptable LOS threshold.

1. Intersection average LOS and delay for signalized intersections and roundabouts, worst movement LOS and delay for unsignalized intersections.
2. Deer Valley Drive East / Deer Valley Drive West intersection analyzed as a reconfigured side-street stop control as a mitigation.

Source: Fehr & Peers.

## 1.1.3 Proposed Mitigations

The traffic operations analyses conducted as part of the report indicate that five study intersections will operate at unacceptable LOS in comparison with Park City's standards under 2040 plus project conditions. Community input gathered through stakeholder engagement resulted in the community-supported mitigations for identified deficiencies stemming from Snow Park Village-generated traffic shown in **Table 2**.

**Table 2: Proposed Mitigations for Snow Park Village-Generated Traffic Impacts**

ID	Location	Control	Deficiency	Proposed Mitigations
1	Doe Pass Rd / Deer Valley Dr East	SSSC <sup>1</sup>	N/A	Signal with transit preemption
2	Doe Pass Rd / Deer Valley Dr West	SSSC	N/A	N/A
3	Queen Esther Dr / Deer Valley Dr East	SSSC	LOS F	N/A
4	Deer Valley Dr East / Solamere Dr	SSSC	LOS F	N/A
5	Deer Valley Dr / Deer Valley Dr East / Deer Valley Dr West	SSSC	LOS F	Reconfigured to allow free movements for traffic flows
6	Deer Valley Drive / Marsac Avenue	Roundabout	N/A	N/A
7	Deer Valley Dr / Bonanza Dr	Signal	LOS F	N/A
8	Deer Valley Dr / Park Ave / Empire Ave	Signal	LOS F	N/A



9	Bonanza Dr / Monitor Dr / SR-248	Signal	N/A	N/A
---	----------------------------------	--------	-----	-----

Notes:

1. SSSC = Side Street Stop Control

Source: Fehr & Peers, 2022

## 1.1.4 Conclusion / Recommendations

With proposed mitigations in place, all study intersections at which mitigations are feasible and supported by the community operate at acceptable levels of service under all Plus Project analysis scenarios. Through dedicated transit infrastructure, improved active transportation connections between the Project and Park City’s existing active transportation network, a fully reworked parking system, and management of ongoing TDM offerings in addition to new measures, the Snow Park Village proposal aligns with the City’s *Transit First* policy by encouraging travel by means other than driving alone.

Implementing a new traffic signal with transit preemption at the intersections of and Doe Pass Road / Deer Valley Drive East will improve traffic operations and support transit. Implementing an off-street, multi-use path around the Deer Valley Drive loop will improve pedestrian and cyclist connectivity adjacent to the project site. Ongoing monitoring of TDM program effectiveness will maintain City-Deer Valley cooperation in pursuit of shared goals.

## 2. Introduction

This study documents the potential transportation-related impacts on local traffic from the proposed Snow Park Village project. The project location is shown in **Figure 1**.

There are several major changes from the previous Transportation Analysis (January, 2022):

1. The main arrival sequence is split between East Deer Valley Drive and West, whereas the previous plan directed the majority of inbound traffic to the east;
2. Elimination of a single transit-only lane. This feature has been eliminated due in large part to community concerns about losing the current bicycles lanes on the Loop, and also due to the minimal travel time savings over the course of the whole bus routes, not just within the Loop;
3. The previous plan had traffic signals at intersections along Deer Valley Drive. These were mitigations in large part to meet a peak LOS concern during peak visitation days. Traffic and safety conditions will be monitored and when technical warrants are met in the future, traffic management mitigation(s) will be analyzed at that point.

The scope of this study analyzes the traffic operations and impacts under the following scenarios:

- Existing (2020) Conditions
- Existing (2020) Plus Project Conditions
- Opening Year (2024) Background Conditions
- Opening Year (2024) Plus Project Conditions
- Future (2040) Background Conditions
- Future (2040) Plus Project Conditions

Traffic operations at key intersections, described below in the Scope section, were analyzed under the six scenarios listed above during Saturday AM and PM peak-hour travel periods. Given the nature of ski areas operating as recreational destinations, Saturdays consistently experience the highest traffic volumes, and focusing on Saturdays for traffic analyses in this report present the most conservative results. The Plus Project analyses include trips generated by the proposed project.

The project team knows that it is important to work with the community to help them better understand the complexity of building out the remaining entitled density at Snow Park and its relation to traffic, and





ensuring that the Deer Valley community can contribute to the planning process. Throughout the project's planning process, and with renewed emphasis since the beginning of 2022, Deer Valley has engaged with most of the lower Deer Valley neighborhoods and that communication continues today. Early outreach was done with the Trails End neighborhood in relation to the right of way vacation to gain their support. After the community voiced their opinion in March 2022, the project team opted to hold individual meetings with various homeowner's associations (HOAs) to address concerns and gather feedback. The community's main concerns were the then-proposed bus-only lanes, removal of on-street bike paths, the proposed routing of most traffic on Deer Valley Drive East, construction of new traffic signals, and pedestrian circulation. Coordination meetings with the community continued with six meetings in summer 2022, with more scheduled. The revised traffic circulation plan as submitted is based on the community's input and support.

## 2.1 Scope

This study analyzes the traffic impacts of the project in conjunction with nearby intersections. Impacts are specifically addressed at the following study intersections:

1. Doe Pass Road / Deer Valley Drive East (side-street stop-controlled)
2. Doe Pass Road / Deer Valley Drive West (side-street stop-controlled)
3. Deer Valley Drive East / Queen Esther Drive (side-street stop-controlled)
4. Deer Valley Drive East / Solamere Drive (side-street stop-controlled)
5. Deer Valley Drive / Deer Valley Drive East / Deer Valley Drive West (side-street stop-controlled)
6. Deer Valley Drive / Marsac Avenue (roundabout)
7. Deer Valley Drive / Bonanza Drive (signalized)
8. Deer Valley Drive / Park Avenue / Empire Avenue (signalized)
9. Bonanza Drive / Monitor Drive / SR-248 (signalized)

For the purposes of consistency, this report refers to two key roadways as Deer Valley Drive East (sometimes called Deer Valley Drive North) and Deer Valley Drive West (sometimes called Deer Valley Drive South). Given that Doe Pass Road carries minimal traffic in its existing configuration, study intersections 1 and 2 are only analyzed under Plus Project scenarios.

Study intersections are shown in **Figure 2**.



Figure 1  
Project Location 



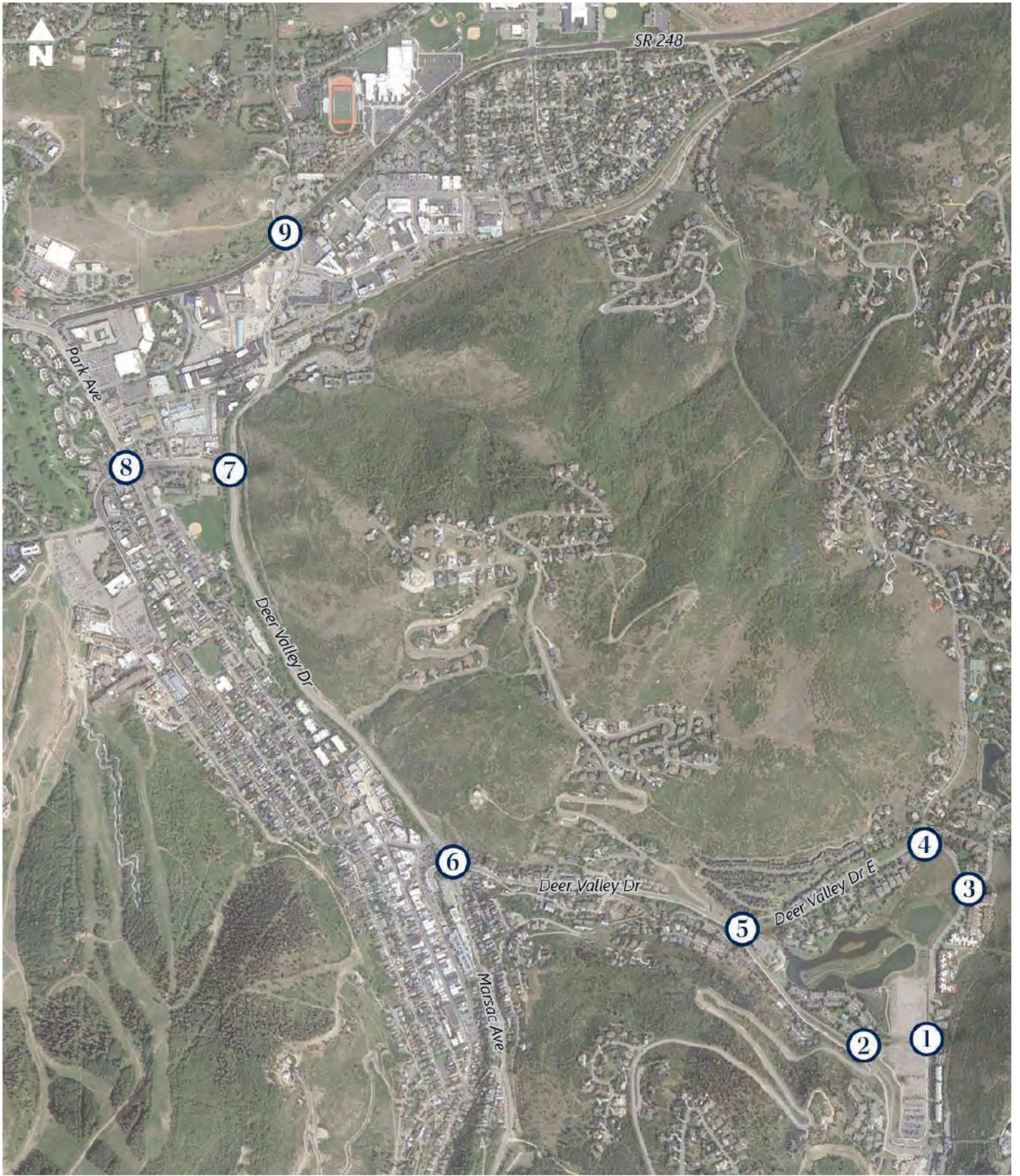

Figure 2  
Study Intersections



## 2.2 Analysis Methodology

“Level of service” (LOS) is a term that describes the operating performance of an intersection or roadway. LOS is measured quantitatively and reported on a scale from A to F, with A representing the best performance and F the worst. **Table 3** provides a brief description of each LOS letter designation and an accompanying average delay per vehicle for both signalized and unsignalized intersections. Traffic operations were modeled in SimTraffic, a microsimulation traffic analysis software. SimTraffic results were evaluated under the Highway Capacity Manual 6<sup>th</sup> Edition (HCM 2016) methodology in this study to remain consistent with “state of the practice” professional standards. For study intersection 4, Deer Valley Drive / Marsac Avenue, the SIDRA analysis software was used as it is accepted as state-of-the-practice for roundabout operations analysis. For signalized intersections and roundabouts, the LOS is provided for the overall intersection (weighted average of all approach delays). Park City Municipal Corporation has an established threshold of acceptable traffic operations as LOS of C for all intersections under its control.

**Table 3: Level of Service Descriptions**

LOS	Description	Signalized Intersections	Unsignalized Intersections	Roundabouts
		Avg. Delay (sec/veh) <sup>1</sup>	Avg. Delay (sec/veh) <sup>2</sup>	Avg. Delay (sec/veh) <sup>3</sup>
A	<i>Free Flow / Insignificant Delay</i> Extremely favorable progression. Individual users are virtually unaffected by others in the traffic stream.	< 10.0	< 10.0	< 10.0
B	<i>Stable Operations / Minimum Delays</i> Good progression. The presence of other users in the traffic stream becomes noticeable.	> 10.0 to 20.0	> 10.0 to 15.0	> 10.0 to 15.0
C	<i>Stable Operations / Acceptable Delays</i> Fair progression. The operation of individual users is affected by interactions with others in the traffic stream	> 20.0 to 35.0	> 15.0 to 25.0	> 15.0 to 25.0
D	<i>Approaching Unstable Flows / Tolerable Delays</i> Marginal progression. Operating conditions are noticeably more constrained.	> 35.0 to 55.0	> 25.0 to 35.0	> 25.0 to 35.0
E	<i>Unstable Operations / Significant Delays Can Occur</i> Poor progression. Operating conditions are at or near capacity.	> 55.0 to 80.0	> 35.0 to 50.0	> 35.0 to 50.0
F	<i>Forced, Unpredictable Flows / Excessive Delays</i> Unacceptable progression with forced or breakdown of operating conditions.	> 80.0	> 50.0	> 50.0

1. Overall intersection LOS and average delay (seconds/vehicle) for all approaches.
  2. Worst approach LOS and delay (seconds/vehicle) only.
  3. Overall intersection LOS and average delay (seconds/vehicle) for all approaches.
- Source: Fehr & Peers descriptions, based on *Highway Capacity Manual, 6<sup>th</sup> Edition*.

## 3. Existing (2020) Background Conditions

The Existing (2020) Background Conditions analysis examines the study intersections and roadways during the AM and PM peak-hours existing traffic and geometric conditions. The existing conditions analyses were performed using traffic data collected in 202. Subsequent rounds of analysis have been used adjusted counts to assume marginal increases in traffic, with growth factors taken from a regional travel model. Through this analysis, existing traffic operational deficiencies can be identified, and potential mitigation measures recommended.

### 3.1 Roadway System

The primary roadways that will provide access to the project, and their existing configurations, are described below.

- **Deer Valley Drive (SR-224)** is a state-owned and managed facility and is classified as a principal arterial road and has a posted speed limit of 35 mph from Park Avenue to about halfway between Bonanza Drive and Marsac Avenue, and 40 mph to the Marsac Avenue roundabout. SR-224 has a five-lane cross section with two travel lanes in each direction with a two-way left-turn lane north of the Marsac Avenue roundabout.
- **Marsac Avenue (SR-224)** is also a state-owned facility and is classified as a principal arterial road and has a posted speed limit of 25 mph. Marsac Avenue has a two-lane cross section with one travel lane in each direction near the project area.
- **Deer Valley Drive West** is classified as a major collector road and has a posted speed limit of 25 mph. Deer Valley Drive West has a two-lane cross section with one travel lane in each direction near the project area.
- **Deer Valley Drive East** this loop section of Deer Valley Drive is classified as a collector road and has a posted speed limit of 25 mph. Deer Valley Drive East has a two-lane cross section with one travel lane in each direction near the project area.
- **Queen Esther Drive** is classified as a collector road and has a posted speed limit of 25 mph. Queen Esther Drive has a two-lane cross section with one unstriped travel lane in each direction near the project area.

- **Solamere Drive** is classified as a collector road and has a posted speed limit of 25 mph. Solamere Drive has a two-lane cross section, with one travel lane in each direction and a landscaped median near the project area.
- **Doe Pass Road** is classified as a collector road and has a posted speed limit of 25 mph. Doe Pass Road has a two-lane cross section with one unstriped travel lane in each direction near the project area.

## 3.2 Traffic Volumes

Intersection turning movement counts were collected at the following study intersections to establish a baseline of existing conditions and operations for this study's original scope of work:

- Deer Valley Drive / Deer Valley Drive East / Deer Valley Drive West
- Deer Valley Drive / Marsac Avenue
- Deer Valley Drive / Bonanza Drive

Intersection turning movement counts were collected at the Deer Valley Drive / Deer Valley Drive East / Deer Valley Drive West intersection on Saturday, February 15, 2020 (President's Day weekend) and Saturday, February 29, 2020 for the Saturday AM peak period (7:45 AM – 9:45 AM) and the Saturday PM peak period (3:30 PM – 5:30 PM). Counts collected on February 29, 2020 showed higher peak-hour traffic volumes, and were therefore used as existing traffic volumes for the analysis presented in this study. While it is highly unusual to analyze operations during absolute peak conditions, due to the risk of over-building infrastructure and exaggerating typical issues, this was the request of the City.

Intersection turning movement counts were collected at the Deer Valley Drive / Marsac Avenue roundabout and the Bonanza Drive / Deer Valley Drive intersection on December 19, 2020 for the Saturday AM and PM peak periods.

The original, City-approved scope for this study included study intersections 5, 6, and 7. As a result of requests from the City and their reviewers for expanded traffic operations analysis beyond that included in the original study. As a result, counts were sourced from other, existing work and adjusted to present conservative results.

Roadway vehicle counts are provided by the Utah Department of Transportation (UDOT) Continuous Count Stations (CCS). Data from the past five years as collected at two CCSs in the vicinity of the project site (one on SR-224 just south of Kimball Junction and one on SR-248 just west of Quinn's Junction) were reviewed



to determine when during the ski season peak traffic volumes occur. It was observed from the data that the month of January experienced the highest Average Daily Traffic (ADT) volumes of any month of the year. This is likely due to increases in traffic caused by events in the area including the Sundance Film Festival. While January is likely the busiest month for traffic on the outskirts of Park City, traffic volumes in February are nearly as high, and Presidents' Day Weekend is among the busiest weekend of the year for skier traffic. To account for this, the intersection volumes collected in December were adjusted by a factor of 1.05 (5% higher) to replicate February conditions.

For study intersections 8 and 9, which were not included in this study's original scope, intersection counts were sourced from previous studies with adjustment factors. For the intersection of Deer Valley Drive / Park Avenue / Empire Avenue, counts were sourced from the *Park City Mountain Resort Traffic Impact Study* (August, 2019). Counts for this study were collected on February 18, 2017 and were adjusted by a factor of 1.14 (14% higher) to account for a peak winter day, as described in the August 2019 study. These adjusted counts were used for this study. For the intersection of Bonanza Drive / Monitor Drive / SR-248, no Saturday counts were available. To overcome this challenge, weekday counts collected on February 6, 2018 as part of the *Park City Arts District Traffic Analysis* (September 2019) were used as a foundation. Through reviewing two years of CCS data, weekday-to-weekend adjustment factors of 0.63 (37% lower) for the AM peak hour, and 0.85 (15% lower) for the PM peak hour were applied for this study.

To address comments from City Staff and community members, turning movement counts were collected at study intersections 3 and 4 to better understand how project-generated traffic might affect local intersections not included in the original study scope. The turning movement counts were collected on Thursday-Saturday, March 3-5, 2022, for the AM and PM peak periods. The highest turning movement counts among the three days at each location were used for conservative results.

Given that they were not included in the original scope of this study, and the substantial changes proposed along Doe Pass Road, no counts for the intersections of Deer Valley Drive East / Doe Pass Road and Deer Valley Drive West / Doe Pass Road were available, and these intersections were only evaluated in the Plus Project conditions.

The existing 2020 background Saturday AM and PM peak hour volumes are shown in **Figure 3**.

Fehr & Peers also collected Saturday daily roadway counts on February 15, 2020 (President's Day weekend) on the internal Deer Valley Drive roadways at the following locations:

- Deer Valley Drive West – between Royal Street and drop-off/pick-up area





- Deer Valley Drive West – south of the Deer Valley Drive East / Deer Valley Drive West intersection
- Deer Valley Drive East – between Queen Esther Drive and parking lot
- Deer Valley Drive East – east of the Deer Valley Drive East / Deer Valley Drive West intersection

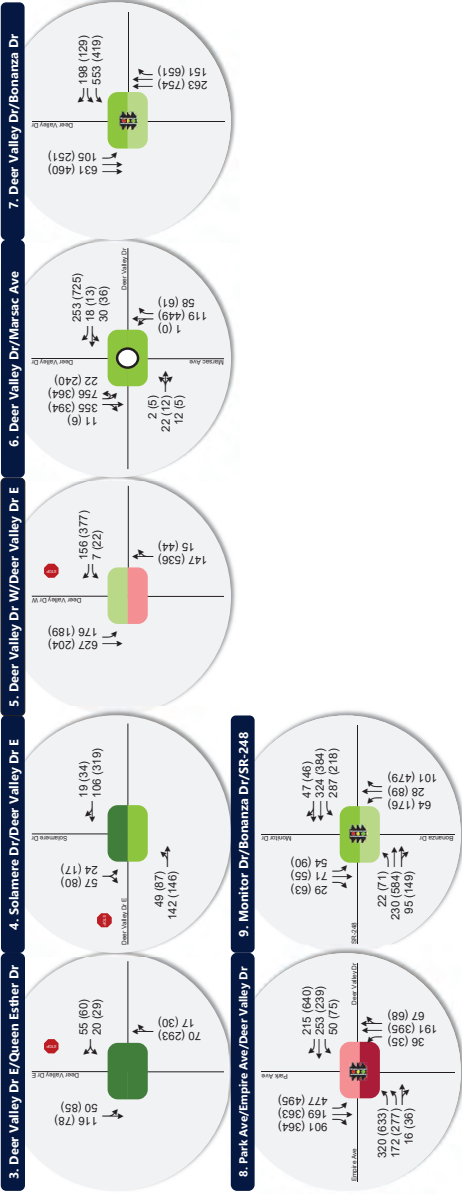

**LEGEND**

- Stop Sign
- Signalized
- Roundabout
- Lane Configuration
- Peak Hour Traffic Volume per lane
- Intersection Level of Service (LOS):
  - A
  - B
  - C
  - D
  - E
  - F
- AM
- PM

Figure 3  
Existing 2020 Background Saturday AM & PM Peak Hour Traffic Conditions

### 3.3 Level of Service Analysis

Using SimTraffic simulation software (for signalized and unsignalized intersections) and SIDRA software (for the roundabout) and the HCM 6 delay thresholds provided in the Introduction, the existing background Saturday AM and PM peak hour LOS were computed for each study intersection. The results of this analysis for the Saturday AM and PM peak hours are reported in **Table 4** (see Appendix for the detailed LOS report). These results serve as a base for the analysis of the impacts of the proposed Snow Park Village development.

**Table 4: Existing 2020 Background Conditions Saturday AM & PM Peak Hour Level of Service**

Intersection				Worst Movement <sup>1</sup>			Overall Intersection <sup>2</sup>	
ID	Location	Period	Control	Movement <sup>3</sup>	Delay Sec/Veh	LOS	Avg. Delay Sec/Veh	LOS
1	Doe Pass Rd / Deer Valley Dr East	AM	SSSC <sup>4</sup>	-	-	-	-	-
		PM		-	-	-	-	-
2	Doe Pass Rd / Deer Valley Dr West	AM	SSSC	-	-	-	-	-
		PM		-	-	-	-	-
3	Queen Esther Dr / Deer Valley Dr East	AM	SSSC	WB Left	6	A	-	-
		PM		WB Left	9	A	-	-
4	Deer Valley Dr East / Solamere Dr	AM	SSSC	SB Left	7	A	-	-
		PM		SB Left	11	B	-	-
5	Deer Valley Dr / Deer Valley Dr East / Deer Valley Dr West	AM	SSSC	WB Left	15	C	-	-
		PM		WB Left	<b>39</b>	<b>E</b>	-	-
6	Deer Valley Drive / Marsac Avenue	AM	Roundabout	-	-	-	11	B
		PM		-	-	-	11	B
7	Deer Valley Dr / Bonanza Dr	AM	Signal	-	-	-	11	B
		PM		-	-	-	21	C
8	Deer Valley Dr / Park Ave / Empire Ave	AM	Signal	-	-	-	<b>77</b>	<b>E</b>
		PM		-	-	-	<b>84</b>	<b>F</b>
9	Bonanza Dr / Monitor Dr / SR-248	AM	Signal	-	-	-	12	B
		PM		-	-	-	20	C

Notes:

**Bold text** indicates intersections operating below Park City's acceptable LOS threshold.

1. This represents the worst approach LOS and delay (seconds/vehicle) and is only reported for unsignalized intersections.
2. This represents the overall intersection LOS and delay (seconds/vehicle) and is only reported for signalized intersections and roundabouts.
3. NB=Northbound, SB=Southbound, EB=Eastbound, WB=Westbound

4. Side-street stop control.

Source: Fehr & Peers.

As shown in **Table 4**, all study intersections operated within acceptable LOS (LOS C or better), with the exception of the following locations:

- Deer Valley Drive East / Deer Valley Drive West: LOS E in the PM peak hour
  - This is caused by the high volumes of vehicles exiting the Deer Valley Resort area making a westbound right turn onto Deer Valley Drive West. The westbound approach is stop-controlled, making it difficult for vehicles to find a gap and turn onto Deer Valley Drive West.
- Deer Valley Drive / Park Avenue / Empire Avenue: LOS E in the AM peak hour, LOS F in the PM peak hour
  - This is caused by congestion at the signal due to high volumes accessing various ski resorts and downtown Park City.

It should be noted that while the Bonanza Drive / Deer Valley Drive intersection operates within acceptable LOS, it is often impacted by vehicle queues spilling back to this intersection from the upstream intersection at Deer Valley Drive / Park Avenue / Empire Avenue in the PM peak hour.

## 3.4 Mitigation Measures

The concept master plan for Snow Park Village shows re-alignment of the Deer Valley Drive / Deer Valley Drive East / Deer Valley Drive West intersection, which will alter the westbound LOS at this intersection. Therefore, Fehr & Peers does not recommend any mitigation measures for existing background conditions.

## 3.5 Origin-Destination Data

To understand the distribution of origins from which travelers access Deer Valley, Fehr & Peers employed origin-destination data provided by StreetLight Data. StreetLight Data collects samples of trips using anonymized mobile phone data (location-based services, or LBS) and aggregates it to provide estimates of travel between origin-destination pairs. In this study, trips to and from surrounding areas (Kamas-Richardson, Kimball-Jeremy, Midway-Heber, North Summit County, Wasatch Front, and Park City Old Town/Mountain Resort) were examined. The data sample used in this study was based on 2019 and 2020 observed travel patterns on weekend days during morning and afternoon peak periods (8:00am-10:00am



and 3:00pm-5:00pm, respectively) in January and February (peak ski months). The figure below displays the distributions of origins for visitors of the Deer Valley Resort, as also shown in **Figure 4**.

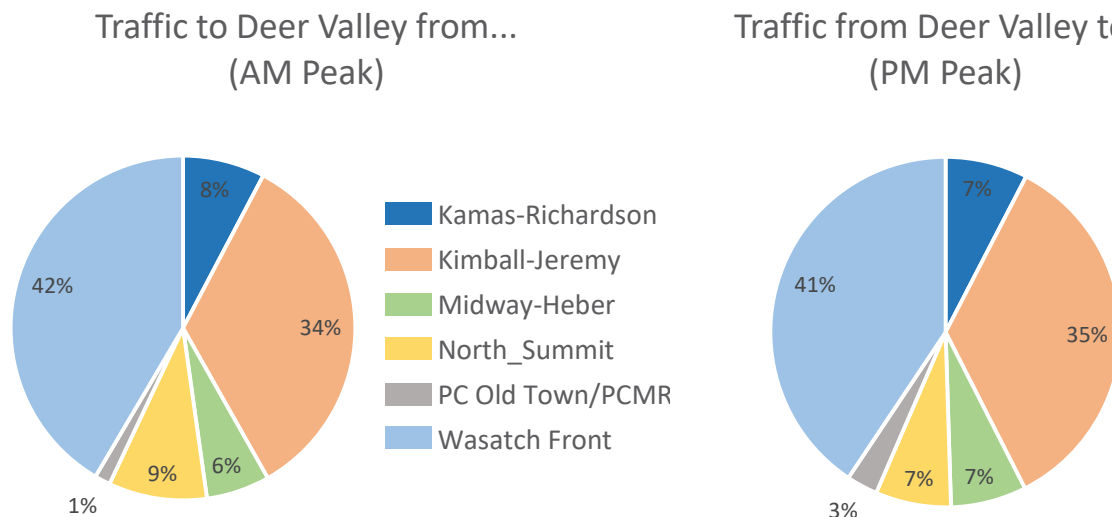

The Wasatch Front contributes the majority of visitors to and from Deer Valley Resort with 42% and 41% in the AM peak and PM peak, respectively. The Kimball-Jeremy area contributes the second-greatest percentage of visitors with 34% and 35% in the AM peak and PM peak, respectively. The vehicular traffic to and from the Kimball-Jeremy area are good candidates to encourage shifting to transit or other modes, especially if improved transit service accessing Deer Valley Resort is provided.

This data represents existing travel patterns and do not account for potential changes in travel following the construction of Snow Park Village; trip distributon and assignment as shown in section 4.4 of this report primarily focuses on new project trips. Furthermore, StreetLight Data can not ditinguish between single-occupancy vehicles and high-occupancy/transit vehicles, and therefor does not account for current carpooling or transit usage.

### 3.6 Vehicle Occupancy Data

In addition to traffic counts and StreetLight Data, Fehr & Peers collected vehicle occupancy counts for AM peak-period, inbound traffic for the Deer Valley Resort. Vehicle occupancy counts were collected for the following three days:

- Saturday, February 13, 2021



- Tuesday, February 23, 2021
- Saturday, February 27, 2021

**Table 5** presents a summary of vehicle occupancy data, calculated from data collected during the three days listed above. It should be noted that the vehicle occupancy counts were collected during the global COVID-19 pandemic, and the data shown in **Table 5** could be skewed because people are less likely to carpool with individuals outside of their immediate home due to risks presented by Covid-19.

In summary, the average vehicle occupancy for Snow Park Village was observed to be 2.02 occupants/vehicle on Saturday (weighted average of the two sample Saturdays), and 1.90 occupants/vehicle on a weekday (from a single weekday). Also, the percent of single-occupant vehicles was observed to be about 36% on Saturday (weighted average of the two sample Saturdays), and about 38% on a weekday (from a single weekday). Vehicle occupancy is a useful metric to have available for baseline conditions, as it can be used in evaluating how future implementation of potential transportation demand management (TDM) strategies and broader transit network improvements could impact travel behavior. It should be noted that, due to the global Covid-19 pandemic, carpooling may be lower than pre-pandemic levels. However, a return to higher rates of carpooling is expected to be achievable in the near future.



**Table 5: Snow Park Village Vehicle Occupancy Summary**

Time Period	Total Vehicle Count	Average Occupancy	Single Occupant Vehicles	Percent Single Occupant Vehicles
<b>Saturday, February 13, 2021</b>				
7:45 – 8:00	45	1.76	19	42%
8:00 – 8:15	58	1.84	23	40%
8:15 – 8:30	59	2.12	17	29%
8:30 – 8:45	68	2.09	19	28%
8:45 – 9:00	74	2.04	26	35%
9:00 – 9:15	26	2.12	12	46%
9:15 – 9:30	22	1.95	10	45%
9:30 – 9:45	20	1.95	7	35%
<b>Sum</b>	<b>372</b>	<b>-</b>	<b>133</b>	<b>-</b>
<b>Weighted Average</b>	<b>-</b>	<b>1.99</b>	<b>-</b>	<b>36%</b>
<b>Tuesday, February 23, 2021</b>				
7:45 – 8:00	15	1.60	6	40%
8:00 – 8:15	32	1.50	22	69%
8:15 – 8:30	48	1.65	24	50%
8:30 – 8:45	56	1.91	17	30%
8:45 – 9:00	63	2.00	23	37%
9:00 – 9:15	48	1.92	16	33%
9:15 – 9:30	43	2.23	11	26%
9:30 – 9:45	24	2.17	5	21%
<b>Sum</b>	<b>329</b>	<b>-</b>	<b>124</b>	<b>-</b>
<b>Weighted Average</b>	<b>-</b>	<b>1.90</b>	<b>-</b>	<b>38%</b>
<b>Saturday, February 27, 2021</b>				
7:45 – 8:00	41	1.66	20	49%
8:00 – 8:15	77	2.04	24	31%
8:15 – 8:30	100	1.91	38	38%
8:30 – 8:45	93	2.11	28	30%
8:45 – 9:00	120	2.28	40	33%
9:00 – 9:15	133	1.98	61	46%
9:15 – 9:30	129	1.97	39	30%
9:30 – 9:45	38	2.13	10	26%
<b>Sum</b>	<b>731</b>	<b>-</b>	<b>260</b>	<b>-</b>
<b>Weighted Average</b>	<b>-</b>	<b>2.03</b>	<b>-</b>	<b>36%</b>

Source: Fehr & Peers.

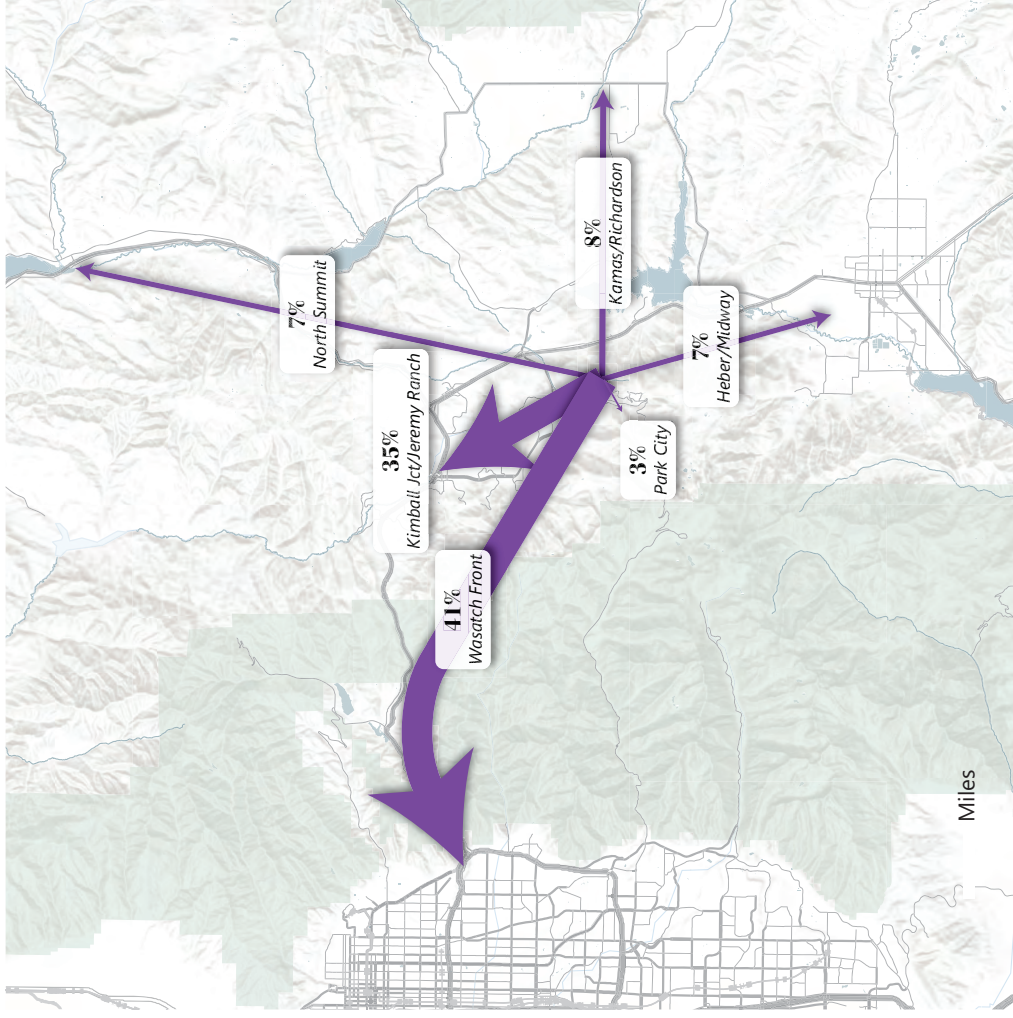
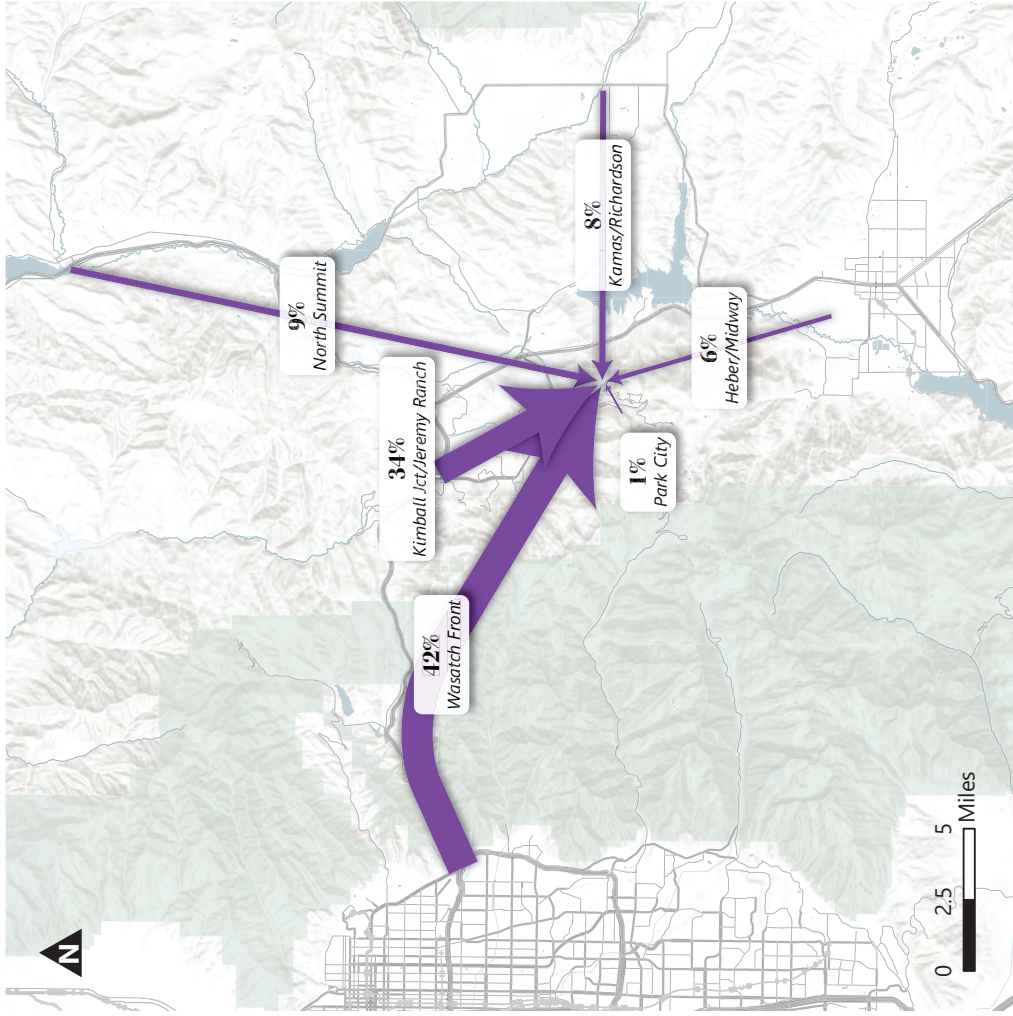

Figure 4  
Deer Valley Origin-Destination AM Incoming - PM Outgoing Trends



## 4. Project Conditions

The Project conditions analysis evaluates the type and intensity of proposed development. This provides the basis for trip generation, distribution, and assignment of project trips to the surrounding study intersections defined in the Introduction. Additionally, Snow Park includes many proposed updates to the roadway network immediately adjacent to the site.

### 4.1 Project Description

The first phase of the proposed Snow Park Village development will be located at the south parcel of the Deer Valley Resort. The parcel is currently surface parking lots for Deer Valley. Deer Valley resort is in a cul-de-sac type of location, and all trips will access the development through the Deer Valley Drive / Deer Valley Drive East/ Deer Valley Drive West intersections.

#### 4.1.1 Site Access and Circulation

The Snow Park Village proposal includes mitigations at key intersections to provide better transit access, especially at the transit hub, and improve the traffic flow for visitors traveling by all modes. While there has been a desire for transit-only lanes to and from the proposed mobility hub, such facilities are not recommended for the following reasons:

1. Due to limited right-of-way, existing on-street bicycle lanes would be eliminated;
2. The Deer Valley Drive loop is not connected to a larger, comprehensive system of transit-only facilities in the city, making any potential travel time savings limited to portions of the roadway network on which they are least likely to provide impactful time savings;
3. The travel time savings for a single bus compared to travel by a passenger car on the Deer Valley Drive loop is around 25 seconds, representing a very short portion of a route travel time of 30 to 40 minutes, depending on the route. From the community's perspective, this travel time savings does not outweigh the impact of removing the existing on-street bike lanes;
4. Enforcement on this relatively short stretch of city road would be challenging and resource-intensive, and likely cause more harm in terms of public perception than good. Enforcement during peak times, in perhaps snowy road conditions, along with visitors new to the area, are recipes for potential distrust in City-led transportation improvements.

**Deer Valley Drive West** will be largely left as it is today. The main entrance for day skiers is the western access off Doe Pass Road into the P2 level. The northbound approach at the Doe Pass Road / Deer Valley Drive West intersection will be stop-controlled. To improve pedestrian and bicycle connections, a continuous multiuse path will be constructed along the west curb to connect Snow Park Village to multimodal facilities along Deer Valley Drive and the broader Park City active transportation network. Adjacent to the Snow Park Village site, Deer Valley Drive West will be gated to control access to the Trails End development and to discourage use of the southern terminus of Deer Valley Drive West as a skier drop off area.

**Doe Pass Road** will be reconfigured to provide access to the parking structure and mobility hub entrances. Doe Pass Road will include two-way general traffic lanes to allow for the movement of public and private vehicles. A continuous multiuse path will be provided on the north side of Doe Pass Road, which will be connected to the multiuse path along the west curb of Deer Valley Drive West by controlled crossings. Two parking accesses, to levels P1 and P2, will be provided on Doe Pass Road. The parking structure will have internal ramping to allow access between P2 and P3. Both driveways will be controlled with parking management technology, and Deer Valley staff as needed.

**Deer Valley Drive East** Two general traffic lanes will be provided on Deer Valley Drive East. A continuous multiuse path will be provided along the west side, which connects to other similar facilities around the Deer valley Drive loop. Deer Valley Drive East will act as the primary route by which day-skiers depart Snow Park Village, which will be supported by the reconfiguration of the Deer Valley Drive / Deer Valley Drive East / Deer Valley Drive West intersection and through intuitive wayfinding. South of its intersection with Doe Pass Road, Deer Valley Drive East will provide access to P2, P3 and P4 parking levels which will primarily serve day skiers. Driveways to these parking levels will be similarly managed through parking technology and Deer Valley staff during periods of peak demand. At its southern terminus, Deer Valley Drive East will be reconfigured into a turnaround drop-off area for day-skier traffic. This drop-off area will be heavily managed, particularly at peak drop-off and pick-up periods with Deer Valley staff directing traffic to ensure smooth operations and safe conditions for users.

A conceptual site plan, showing driveway locations and conceptual roadway configurations is shown in **Figure 5**.



Source: IBI Group

## 4.2 Trip Generation

Much research and case studies have been performed to better understand the transportation benefits of mixed-use development and transit-oriented development (TOD) over the past decade. “D” factors affect the way mixed-use developments generate trips. The “D” factors include:

- Density (*dwelling, jobs per acre*)
- Diversity (*mix of housing, jobs, retail*)
- Design (*connectivity, walkability*)
- Destinations (*regional accessibility*)
- Distance to Transit (*rail and bus proximity*)
- Development Scale (*population, jobs*)
- Demographics (*household size, income*)

Because of the “D” factors, mixed-use developments and TOD have a much higher distribution of mode split (split between walk, bike, transit, and vehicle) and generally result in lower single-occupant vehicle trips and parking demand. Research has shown that mixed-use developments and TOD generate one-third to two-thirds fewer trips than typical state-of-the-practice trip generation methodologies.

Trip generation for the proposed Snow Park Village was obtained from the *Institute of Transportation Engineers – 10th Edition Trip Generation Manual* (ITE Manual) and Fehr & Peers’ mixed-use development (MXD+) methodology via MainStreet, a Fehr & Peers web application that captures the traffic benefits of developments by looking at interactions among the mixture of land uses and patron usage of alternative modes (i.e. transit, bicycling, and/or walking). MXD+ outputs are included in the appendix of this report.

The MXD+ trip generation methodology more accurately captures the trip-reducing benefits of mixed-use development projects and is used throughout the United States to help developers, agencies, and the public to quantify these trip reductions. The MXD+ trip generation model is promoted by the United States Environmental Protection Agency (EPA) and has been adopted by the American Society of Civil Engineers (ASCE), American Planning Association (APA), and many others as a recommended resource for trip generation of smart-growth developments. The MXD+ model uses ITE trip generation rates and applies additional variables to those trip generation rates. Some of the additional variables include:

- Employment
- (Population + Employment) per square mile
- Land area





- Total jobs / population diversity
- Number of intersections per square mile
- Employment within a mile; within
- Employment within a 30-minute trip by transit
- Average household size
- Vehicles owned per capita

Trip generation for the project was computed using trip generation rates published in the Institute of Transportation Engineers (ITE) Trip Generation, 10th Edition, 2017, with trip reductions based on Fehr & Peers' MXD+ methodology to account for the project's many complementary land uses and availability of transit. These reductions were further informed by inputs from the Summit County Travel Demand Model to better tailor results to local travel behavior. Snow Park Village is proposed to include following land uses (taken from the land use program dated October 2021):

- 30,900 square feet of ballroom/event center space
- 143 multifamily housing units
- 193 hotel rooms
- 25,900 square feet of commercial/retail space

The development is proposed to support the current Deer Valley Resort and other land uses in adjacent to the resort. It should be noted that the land uses supporting the ski resort will not be substantial traffic generators; rather, the ski resort will be the primary generator of traffic, and the support land uses serve as accessories to the resort. The current traffic accessing the ski resort were assumed to cover the trip generation for the ski resort and the support land uses independent of the Snow Park Village proposal. **Table 6** presents the Saturday daily, AM peak-hour, and PM peak-hour trip generation estimates for the proposed Snow Park Village Project.

#### 4.2.1.1 Resort Hotel Trip Generation Rates

Trip Generation estimates for the hotel uses included in the Snow Park Village proposal are based on observed trip generation rates recorded during the development of the 2018 Canyons Village Transportation Master Plan. While there are a handful of key factors that might result in trip generation rates closer to those in the original Snow Park Village Traffic Impact Study, including proximity to the interstate and other complementary land uses, estimates in this memorandum used the local rates recorded at the Canyons.



#### **4.2.1.2 Assumed Mode Shift**

To avoid double-counting potential reductions, the trip generation estimates in this memorandum rely solely on mode shift derived from the MXD methodology and underlying assumptions from the regional travel demand model. These reductions, which are shown in the columns titled “% Walk/Bike” and “% Transit,” are applied to all proposed land uses. This results in a more conservative and defensible analysis; however, it does not account for potential changes to transit service in Park City, including potential development of remote park and ride lots, and the world-class transit facility proposed as part of the Snow Park Village project. Potential mode shift to transit for those traveling to and from Deer Valley may be higher following such improvements.

#### **4.2.1.3 Reduction in Vehicle Trips due to Implementation of Paid Parking**

Charging for parking is a reliable method by which to influence mode choice, and Deer Valley intends to implement paid parking as part of the Snow Park Village proposal. Reductions in trip generation due to the implementation of paid parking at Deer Valley have been scaled back to present a more conservative estimate of how parking pricing will affect trip generation. While many Deer Valley clientele may be much less sensitive to additional costs associated with a day’s skiing than the general population, almost 45% of existing trips to and from Deer Valley start and end at points along the Wasatch Front, residents of which are more likely to alter their behavior based on willingness to pay. Lastly, reductions in trip generation due to the implementation of parking pricing are applied only to the resort hotel-, shopping center-, and event center-generated trips, since proposed residential uses at the site are unlikely to require that residents pay for parking on a daily basis.

#### **4.2.1.4 Trip Internalization Derived from MXD**

A fundamental element of the Snow Park Village proposal is to provide amenities, services, and entertainment options that complement each other and the ski resort itself. This means that peak-hour trips that might occur without complementary land uses are either delayed (so that they do not occur during the peak hours) or do not require a vehicle trip due to proximity of different uses. Trip internalization rates, presented in **Table 6** under the column heading “% Internal Capture” are applied only to the residential-, resort hotel-, and recreational community center-generated trips, and present a more conservative rate of internalization than presented in the original Snow Park Village traffic impact study.



#### **4.2.1.5 Trip Internalization Derived from Squaw Valley (Palisades Tahoe)**

While the residential, hotel, and community center uses are expected to be destinations unto themselves that will generate a measurable number of peak-hour vehicle trips, the food service and retail uses (shown in **Table 6** as “Shopping Center”) are expected to almost exclusively serve guests already at Deer Valley rather than guests traveling to Deer Valley explicitly for those services.

To support this assumption, trip generation estimates for the shopping center uses in this memorandum rely on trip internalization estimates derived from an origin-destination survey conducted at the Squaw Valley, California resort in 2011. Surveys conducted showed that 95-97% of customers at dining and retail uses in a similar context (ski resort base village) were already at the village for other purposes, and did not travel solely for the dining/retail use. Reductions based on the data from Squaw Valley are presented under the column heading “% Resort Int. Capt.” And are applied only to the shopping center uses. We assume that employees for these uses will almost exclusively arrive and depart during off-peak periods, resulting in lower reductions for daily trips generated by the shopping center uses.

Trip generation for Snow Park Village is covered in greater detail in **Attachment A**.

**Table 6: Snow Park Village Trip Generation**

Land Use <sup>1</sup>	Number of Units	Unit Type	Rate <sup>2</sup>	Daily Trip Generation <sup>3</sup>	% Entering <sup>4</sup>	% Exiting <sup>4</sup>	% Walk/ Bike <sup>5</sup>	% Transit <sup>5</sup>	% Paid Parking <sup>7</sup>	% Internal Capture <sup>6</sup>	% Resort Int. Capt. <sup>8</sup>	Trips Entering	Trips Exiting	New Daily Trips
(220) - Multifamily Housing Low-Rise	143	Dwelling Unit	8.14	1,164	50%	50%	4.6%	3.0%	-	1.9%	-	527	527	1,054
(330) - Resort Hotel	193	Rooms	6.27	1,210	50%	50%	4.6%	3.0%	15.0%	1.9%	-	457	457	914
(820) - Shopping Center	25.9	1,000 Sq. Ft	46.12	1,195	50%	50%	4.6%	3.0%	15.0%	-	90.0%	47	47	94
(495) Recreational Community Center	30.9	1,000 Sq. Ft	9.10	281	50%	50%	4.6%	3.0%	15.0%	1.9%	-	107	107	214
<b>Net Weekday Trips</b>				<b>3,850</b>								<b>1,138</b>	<b>1,138</b>	<b>2,276</b>
Land Use <sup>1</sup>	Number of Units	Unit Type	Rate <sup>2</sup>	AM Peak Hour Trip Generation <sup>3</sup>	% Entering <sup>4</sup>	% Exiting <sup>4</sup>	% Walk/ Bike <sup>5</sup>	% Transit <sup>5</sup>	% Paid Parking <sup>7</sup>	% Internal Capture <sup>6</sup>	% Resort Int. Capt. <sup>8</sup>	Trips Entering	Trips Exiting	New AM Peak Hour Trips
(220) - Multifamily Housing Low-Rise	143	Dwelling Unit	0.46	66	77%	77%	5.6%	1.9%	-	3.7%	-	14	45	59
(330) - Resort Hotel	193	Rooms	0.41	79	72%	28%	5.6%	1.9%	15.0%	3.7%	-	43	17	60
(820) - Shopping Center	25.9	1,000 Sq. Ft	0.94	24	62%	38%	5.6%	1.9%	15.0%	-	96.2%	1	1	2
(495) Recreational Community Center	30.9	1,000 Sq. Ft	1.76	54	62%	38%	5.6%	1.9%	15.0%	3.7%	-	25	16	41
<b>Net Saturday AM Peak Hour Trips</b>				<b>224</b>								<b>83</b>	<b>79</b>	<b>162</b>
Land Use <sup>1</sup>	Number of Units	Unit Type	Rate <sup>2</sup>	PM Peak Hour Trip Generation <sup>3</sup>	% Entering <sup>4</sup>	% Exiting <sup>4</sup>	% Walk/ Bike <sup>5</sup>	% Transit <sup>5</sup>	% Paid Parking <sup>7</sup>	% Internal Capture <sup>6</sup>	% Resort Int. Capt. <sup>8</sup>	Trips Entering	Trips Exiting	New PM Peak Hour Trips
(220) - Multifamily Housing Low-Rise	143	Dwelling Unit	0.70	100	60%	40%	3.4%	2.9%	-	10.6%	-	50	34	84
(330) - Resort Hotel	193	Rooms	0.70	135	43%	57%	3.4%	2.9%	15.0%	10.6%	-	40	53	93
(820) - Shopping Center	25.9	1,000 Sq. Ft	4.50	117	52%	48%	3.4%	2.9%	15.0%	-	96.2%	2	2	4
(495) Recreational Community Center	30.9	1,000 Sq. Ft	1.07	33	52%	48%	3.4%	2.9%	15.0%	10.6%	-	12	11	23
<b>Net Saturday PM Peak Hour Trips</b>				<b>385</b>								<b>104</b>	<b>100</b>	<b>204</b>

1. (XXX) indicates ITE Land Use Code. Land Use Code from the Institute of Transportation Engineers - 10th Edition Trip Generation Manual (ITE Manual)

2. ITE Trip Generation Rates. Hotel rates derived from data collected on Saturday, February 17, 2018, for the Canyons Village Management Association Transportation Master Plan.

3. Traffic Generated by the development according to trip generation rates provided in the ITE Manual (custom rates for Hotel).

4. Percentage of trips Entering and Exiting the development according to the ITE Manual.

5. Percentage of trips that shift to active transportation or transit modes based on data collected by U.S. Census Bureau, 2013-2017 American Community Survey 5-Year Estimates.

6. Percentage of trips that are captured internally to the site based on rates published in ITE Manual.

7. Percentage of trips that shift to transit due to parking costs based on Fehr & Peers's Parking Cost Tool. The tool estimates close to 20%, 15% assumed for conservative results.

8. Percentage of trips that are captured internally to the site for retail/restaurant based on Squaw Valley winter overnight visitor survey conducted in 2011, for weekend AM and PM peak hours.

9. Daily retail/restaurant internal capture percentage was assumed to be lower than AM and PM peak hours due to employees, which daily travel patterns are not as affected as much as peak hours.

Source: Fehr & Peers



## 4.3 Trip Distribution and Assignment

Project traffic was assigned to the roadway network based on the proximity to major streets and freeways, population densities, and local and regional attractions. Existing travel patterns revealed in the Streetlight data, Continuous Count Station (CCS) data collection from UDOT, and observed during data collection also provided helpful guidance to establish these distribution percentages, especially close to the site.

The CCS data from UDOT informed the distribution of trips arriving via SR-224 and SR-248. Closer to the project site, Streetlight data informed the distribution of trips arriving via Marsac Avenue and Deer Valley Drive. Overall, the project-generated trips were distributed to and from these directions in the Existing analysis, in the corresponding percentages:

- 50% North (using SR-224)
- 20% East (using SR-248 via Bonanza Drive)
- 15% West (using any of the accesses along Deer Valley Drive between Bonanza and Marsac)
- 5% West (using the Transit Hub access at the Marsac Roundabout)
- 10% South (using Marsac Avenue)

This trip distribution does not fully align with the origin-destination data presented in **Figure 4** due to the expected differences in trip purpose stemming from the change in land use at Snow Park. The distribution and assignment of new, project-generated trips reflects the assumption that residents and guests of Snow Park Village's hotel and residential uses are more likely to and from Old Town for dining, shopping, or entertainment purposes.

These trip distribution assumptions were used to distribute project-generated traffic to the study area intersections and are shown in **Figure 6**.

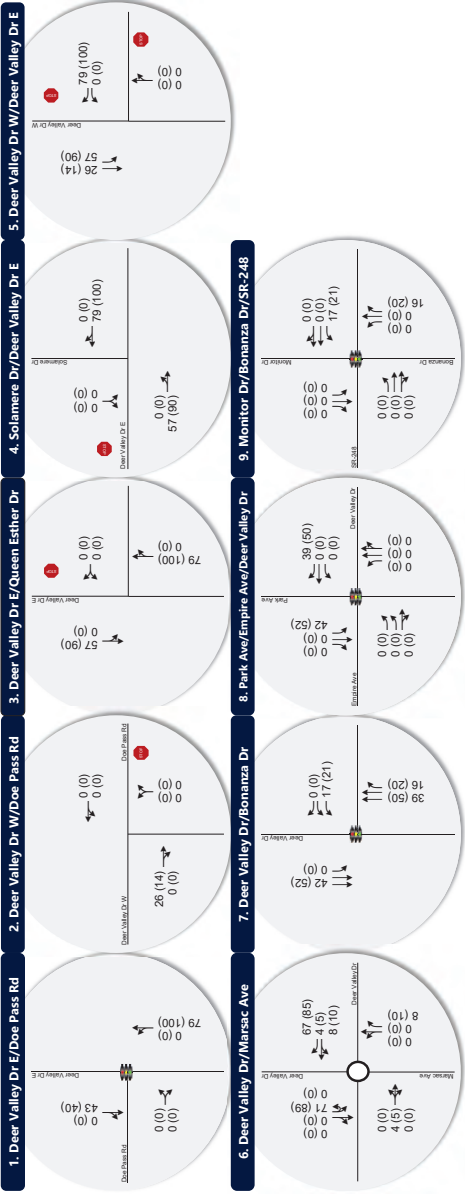

**LEGEND**

- Stop Sign
- Signalized
- Roundabout
- Lane Configuration
- Peak Hour Traffic Volume per lane
- Intersection Level of Service (LOS): A, B, C, D, E, F
- AM, PM

Figure 6  
 Saturday AM & PM Peak Hour Trip Generation and Distribution



## 5. Existing 2020 plus Project Conditions

The Existing (2020) Plus Project conditions analysis evaluates the impact of the proposed development-generated traffic on the surrounding roadway network under existing conditions. To analyze this impact, the Saturday peak-hour background traffic volumes were combined with volumes generated by the proposed Project during its Saturday peak hours. Intersection LOS analyses were then performed and compared to the results of the background traffic volumes. This comparison shows the impact of the proposed project.

### 5.1 Traffic Volumes

Vehicle trips in and out of the existing Deer Valley resort are assumed to be for the ski resort users and were not subtracted out from the background volumes. Project-generated traffic for the additional land uses and development was added to the background volumes to yield Existing (2020) Plus Project peak-hour volumes. The Saturday AM and PM peak-hour traffic volumes at the study intersections are shown in **Figure 7**.

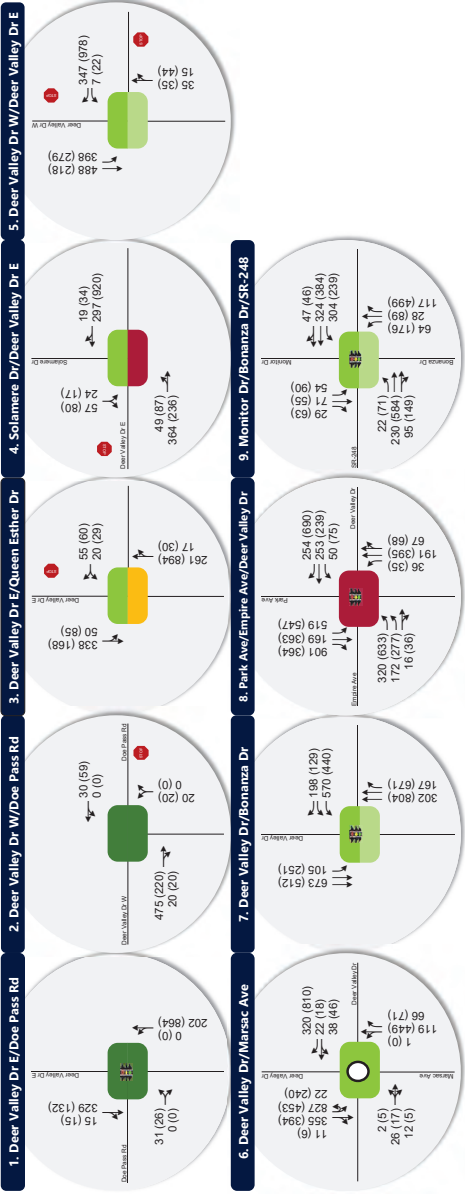

**LEGEND**

- Stop Sign
- Signalized
- Roundabout
- Lane Configuration
- Peak Hour Traffic Volume per lane
- Intersection Level of Service (LOS):
  - A
  - B
  - C
  - D
  - E
  - F

Figure 7  
 Existing 2020 Plus Project Saturday AM & PM Peak Hour Traffic Conditions

## 5.2 Level of Service Analysis

Using SimTraffic simulation software (for signalized and unsignalized intersections) and SIDRA software (for the roundabout) and the HCM 6 delay thresholds provided in the Introduction, the existing 2020 plus project Saturday AM and PM peak hour LOS were computed for each study intersection. The results of the analysis are reported in **Table 7** (see Appendix for the detailed LOS report).

**Table 7: Existing 2020 plus Project Conditions Saturday AM & PM Peak Hour Level of Service**

Intersection				Worst Movement <sup>1</sup>			Overall Intersection <sup>2</sup>	
ID	Location	Period	Control	Movement <sup>3</sup>	Delay Sec/Veh	LOS	Avg. Delay Sec/Veh	LOS
1	Doe Pass Rd / Deer Valley Dr East	AM	Signal	-	-	-	2	A
		PM		-	-	-	2	A
2	Doe Pass Rd / Deer Valley Dr West	AM	SSSC <sup>4</sup>	NB Left	10	B	-	-
		PM		NB Left	12	B	-	-
3	Queen Esther Dr / Deer Valley Dr East	AM	SSSC	WB Left	7	A	-	-
		PM		WB Left	8	A	-	-
4	Deer Valley Dr East / Solamere Dr	AM	SSSC	SB Left	7	A	-	-
		PM		SB Left	13	B	-	-
5	Deer Valley Dr / Bonanza Dr	AM	Signal	-	-	-	11	B
		PM		-	-	-	<b>164</b>	<b>F</b>
6	Deer Valley Drive / Marsac Avenue	AM	Roundabout	-	-	-	12	B
		PM		-	-	-	13	B
7	Deer Valley Dr / Bonanza Dr	AM	Signal	-	-	-	11	B
		PM		-	-	-	26	C
8	Deer Valley Dr / Park Ave / Empire Ave	AM	Signal	-	-	-	<b>78</b>	<b>E</b>
		PM		-	-	-	<b>86</b>	<b>F</b>
9	Bonanza Dr / Monitor Dr / SR-248	AM	Signal	-	-	-	12	B
		PM		-	-	-	20	C

Notes:

**Bold text** indicates intersections operating below Park City's acceptable LOS threshold.

1. This represents the worst approach LOS and delay (seconds/vehicle) and is only reported for unsignalized intersections.
2. This represents the overall intersection LOS and delay (seconds/vehicle).
3. NB=Northbound, SB=Southbound, EB=Eastbound, WB=Westbound
4. Side-street stop control.

Source: Fehr & Peers.





As shown in **Table 7**, all study intersections operated within acceptable LOS (LOS C or better), with the exception of the following locations:

- Deer Valley Drive East / Deer Valley Drive West: LOS F in the PM peak hour
  - This is caused by the high traffic volumes exiting the Deer Valley Resort area making a westbound right turn onto Deer Valley Drive. The westbound approach is stop-controlled, making it difficult for vehicles to find a gap and turn onto Deer Valley Drive West.
- Deer Valley Drive / Park Avenue / Empire Avenue: LOS E in the AM peak hour, LOS F in the PM peak hour
  - This is caused by high congestion at the signal due to high volumes accessing various ski resorts and downtown Park City.

It should be noted that the proposed Snow Park Village development introduces various support land uses intended to attract resort users to stay on-site after the ski resort peak hour. This will help distribute the peaking of traffic, reducing delays at the study intersections and roadways. Therefore, the results shown in **Table 7** are likely overstated.

## 5.3 Mitigation Measures

The Snow Park Village site plan includes realignment of the Deer Valley Drive / Deer Valley Drive East / Deer Valley Drive West intersection. The intersection is currently a “T”-intersection with free-flow movement north/south along Deer Valley Drive West / Deer Valley Drive, and a stop-control on the approach of Deer Valley Drive East. The proposed re-alignment allows free-flow movement east/west along Deer Valley Drive East and stop-control on the northbound approach on Deer Valley Drive West, as shown in **Figure 8**. Deer Valley Drive West will serve as a primary transit and auto route to access the proposed transit hub and the main P2 parking level entrance on Doe Pass Road and serve private vehicles accessing Royal Street and the Trail’s End community. Deer Valley Drive East will serve as the secondary vehicular route to access the Snow Park drop-off/pick-up area and parking structure accesses that includes day skier spaces, hotel, and residences.

To account for this shift in traffic on Deer Valley Drives East and West stemming from intersection realignment, proposed wayfinding, and the placement of site access along Deer Valley Drive East, analyses presented in this report assume that roughly 45% of the total traffic would use Deer Valley Drive East and roughly 55% of the total traffic would use Deer Valley Drive West inbound in the AM peak hour, and roughly 90% of the traffic would use Deer Valley Drive East and roughly 10% of the traffic would use Deer Valley



Drive West outbound in the PM peak hour. This yields conservative results with regards to changes in travel behavior and will rely on various on- and off-site improvements to be realistically achieved. Background traffic was shifted and modified to account for the proposed shift in circulation.

Park City has a longstanding position of not mitigating certain deficient intersections within its boundaries due to the impacts of road widening and other potential mitigations to the community. As a result, potential mitigations at the intersections of Deer Valley Drive / Park Avenue / Empire Avenue, Bonanza Drive / Monitor Drive / SR-248 were not analyzed as part of this study, and are therefore not included as recommendations. Further, deficiencies shown at the intersection of Deer Valley Drive / Bonanza Drive are not a result of project-generated trips or operations of the intersection itself; instead they stem from vehicle queues from the intersection of Deer Valley Drive / Park Avenue / Empire Avenue. As a result, mitigations at the intersection of Deer Valley Drive / Bonanza Drive are not recommended as part of this study. As stated earlier, Deer Valley Drive between the roundabout and SR-224 intersection is a UDOT facility. Any efforts to improve traffic will be led by UDOT.

The analysis results with the reconfigured Deer Valley Drive East / Deer Valley Drive West intersection are shown in **Table 8** (see Appendix for the detailed LOS report). As shown in **Table 8**, the Deer Valley Drive / Deer Valley Drive East / Deer Valley Drive West intersection operates at LOS B and LOS C in the AM and PM peak hour, respectively.

With the redistributed traffic due to the proposed circulation, the Deer Valley Drive East / Solamere Drive intersection now operates at LOS F (this is due to a single movement, therefore the whole intersection gets this grade) in the PM peak hour. A sensitivity analysis (described later in Section 11.1.2.1 of this report) indicated that there are no issues at this location during non-peak conditions. However, it is recommended that this location be monitored and determine if further traffic control is needed when warranted to improve traffic flow and safety. During periods of peak traffic, Deer Valley will work with City staff to implement manual traffic controls at the Deer Valley Drive East / Solamere Drive intersection.





Source: Alliance Engineering Inc



Figure 8

Proposed Reconfiguration of Deer Valley Drive East / Deer Valley Drive West Intersection

**Table 8: Existing 2020 plus Project Mitigated Conditions Saturday AM & PM Peak Hour Level of Service**

Intersection				Worst Movement <sup>1</sup>			Overall Intersection <sup>2</sup>	
ID	Location	Period	Control	Movement <sup>3</sup>	Delay Sec/Veh	LOS	Avg. Delay Sec/Veh	LOS
1	Doe Pass Rd / Deer Valley Dr East	AM	Signal	-	-	-	2	A
		PM		-	-	-	3	A
2	Doe Pass Rd / Deer Valley Dr West	AM	SSSC <sup>4</sup>	NB Left	6	A	-	-
		PM		NB Left	6	A	-	-
3	Queen Esther Dr / Deer Valley Dr East	AM	SSSC	WB Left	10	B	-	-
		PM		WB Left	<b>27</b>	<b>D</b>	-	-
4	Deer Valley Dr East / Solamere Dr	AM	SSSC	SB Left	12	B	-	-
		PM		SB Left	<b>55</b>	<b>F</b>	-	-
5	Deer Valley Dr / Deer Valley Dr East / Deer Valley Dr West	AM	SSSC	WB Left	13	B	-	-
		PM		WB Left	17	C	-	-
6	Deer Valley Drive / Marsac Avenue	AM	Roundabout	-	-	-	12	B
		PM		-	-	-	13	B
7	Deer Valley Dr / Bonanza Dr	AM	Signal	-	-	-	11	B
		PM		-	-	-	30	C
8	Deer Valley Dr / Park Ave / Empire Ave	AM	Signal	-	-	-	<b>75</b>	<b>E</b>
		PM		-	-	-	<b>87</b>	<b>F</b>
9	Bonanza Dr / Monitor Dr / SR-248	AM	Signal	-	-	-	13	B
		PM		-	-	-	21	C

Notes:

**Bold text** indicates intersections operating below Park City's acceptable LOS threshold.

1. This represents the worst approach LOS and delay (seconds/vehicle) and is only reported for unsignalized intersections.

2. This represents the overall intersection LOS and delay (seconds/vehicle).

3. NB=Northbound, SB=Southbound, EB=Eastbound, WB=Westbound

Source: Fehr & Peers.

## 6. Opening Year (2024) Background Conditions

The purpose of the Opening Year (2024) Background conditions analysis is to evaluate the study intersections during the peak travel periods of the day under projected 2024 traffic volumes, when the development is projected to open. This analysis provides a baseline condition for the year 2024, which can be used to determine future Project impacts.

### 6.1 Traffic Volumes

Traffic volumes for 2024 were estimated using traffic counts and forecasted volumes from the Summit/Wasatch Travel Demand Model (September 2020 version) for 2024. This is a regional forecasting model developed with UDOT support to help plan for major infrastructure in the Wasatch Back region. The Summit/Wasatch Travel Demand Model shows a lower growth rate in the future by accounting for a higher mode split for non-drive alone modes of transportation – higher usage of transit, walking, and biking than previous versions of travel demand models. The following growth rates used on the following roadways to project 2024 background weekday volumes as shown in **Figure 9**.

- 0.5% on Deer Valley Drive (SR-224) north of Bonanza Drive
- 0.5% on Deer Valley Drive (SR-224) south of Bonanza Drive
- 0.5% on Deer Valley Drive (SR-224) north of Marsac Avenue
- 0.6% on Deer Valley Drive (SR-224) east of Marsac Avenue
- 0.6% on Deer Valley Drive (SR-224) north of Deer Valley Drive West
- 0.4% on Deer Valley Drive (SR-224) south of Deer Valley Drive West
- 1.7% on Bonanza Drive
- 0.3% on Marsac Avenue

### 6.2 Level of Service Analysis

Using SimTraffic simulation software (for signalized and unsignalized intersections) and SIDRA software (for the roundabout) and the HCM 6 delay thresholds provided in the Introduction, opening year 2024 background weekday peak hour LOS was computed for each study intersection. The results of this analysis for the Saturday AM and PM peak hour are reported in **Table 9** (see Appendix for the detailed LOS report).



**Table 9: Opening Year 2024 Background Conditions Saturday AM & PM Peak Hour Level of Service**

Intersection				Worst Movement <sup>1</sup>			Overall Intersection <sup>2</sup>	
ID	Location	Period	Control	Movement <sup>3</sup>	Delay Sec/Veh	LOS	Avg. Delay Sec/Veh	LOS
1	Doe Pass Rd / Deer Valley Dr East	AM	SSSC <sup>4</sup>	-	-	-	-	-
		PM		-	-	-	-	-
2	Doe Pass Rd / Deer Valley Dr West	AM	SSSC	-	-	-	-	-
		PM		-	-	-	-	-
3	Queen Esther Dr / Deer Valley Dr East	AM	SSSC	WB Left	6	A	-	-
		PM		WB Left	8	A	-	-
4	Deer Valley Dr East / Solamere Dr	AM	SSSC	SB Left	6	A	-	-
		PM		SB Left	11	B	-	-
5	Deer Valley Dr / Deer Valley Dr East / Deer Valley Dr West	AM	SSSC	WB Left	14	B	-	-
		PM		WB Left	<b>41</b>	<b>E</b>	-	-
6	Deer Valley Drive / Marsac Avenue	AM	Roundabout	-	-	-	11	B
		PM		-	-	-	11	B
7	Deer Valley Dr / Bonanza Dr	AM	Signal	-	-	-	11	B
		PM		-	-	-	20	C
8	Deer Valley Dr / Park Ave / Empire Ave	AM	Signal	-	-	-	<b>82</b>	<b>F</b>
		PM		-	-	-	<b>85</b>	<b>F</b>
9	Bonanza Dr / Monitor Dr / SR-248	AM	Signal	-	-	-	13	B
		PM		-	-	-	20	C

Notes:

**Bold text** indicates intersections operating below Park City's acceptable LOS threshold.

1. This represents the worst approach LOS and delay (seconds/vehicle) and is only reported for unsignalized intersections.
2. This represents the overall intersection LOS and delay (seconds/vehicle) and is only reported for signalized intersections and roundabouts.
3. NB=Northbound, SB=Southbound, EB=Eastbound, WB=Westbound
4. Side-street stop control.

Source: Fehr & Peers.

As shown in **Table 9**, all study intersections operated within acceptable LOS (LOS C or better), with the exception of the following locations:

- Deer Valley Drive East / Deer Valley Drive West: LOS E in the PM peak hour
  - This is caused by the high volumes of vehicles exiting the Deer Valley Resort area making a westbound right turn onto Deer Valley Drive West. The westbound approach is stop-



controlled, making it difficult for vehicles to find a gap and turn onto Deer Valley Drive West.

- Deer Valley Drive / Park Avenue / Empire Avenue: LOS F in both AM and PM peak hours
  - This is caused by high congestion at the signal due to high volumes accessing various ski resorts and downtown Park City.

It should be noted that while the Bonanza Drive / Deer Valley Drive intersection operates within acceptable LOS, it is often impacted by vehicle queues spilling back to this intersection from the upstream intersection at Deer Valley Drive / Park Avenue / Empire Avenue in the PM peak hour.

## 6.3 Mitigation Measures

The concept master plan for Snow Park Village shows re-alignment of the Deer Valley Drive East / Deer Valley Drive West intersection, which will alter the westbound LOS at this intersection. Therefore, Fehr & Peers does not recommend any mitigation measures for opening year background conditions.

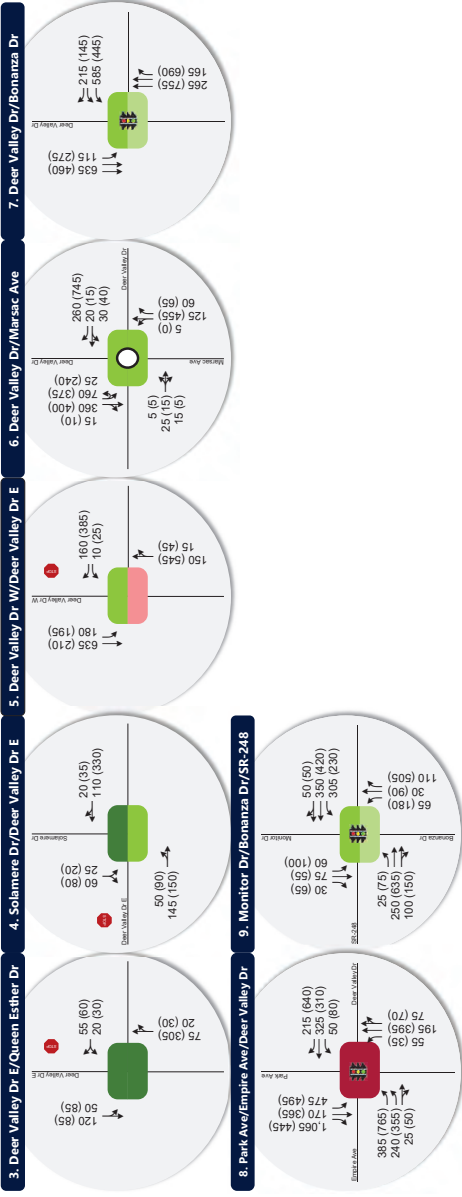

**LEGEND**

- Stop Sign
- Signalized
- Roundabout
- Lane Configuration
- Peak Hour Traffic Volume per lane
- Intersection Level of Service (LOS): A, B, C, D, E, F
- AM, PM



Figure 9  
Opening Year 2024 Background Saturday AM & PM Peak Hour Traffic Conditions



## 7. Opening Year (2024) Plus Project Conditions

The purpose of the opening year 2024 plus project conditions analysis is to evaluate the impact of the proposed development traffic on the surrounding roadway network in the year 2024, the proposed opening year of the development. To analyze this impact, the projected 2024 Saturday AM and PM peak hour background traffic volumes were combined with volumes generated by the development for the Saturday AM and PM peak hours. Intersection LOS analyses were then performed and compared to the results of the background traffic volumes. This comparison shows the impact of the proposed project in opening year 2024.

### 7.1 Traffic Volumes

Project-generated traffic (**Figure 6**) was added to the opening year 2024 background volumes (**Figure 9**) to yield Opening Year (2024) Plus Project Saturday AM and PM peak-hour traffic volumes at the study intersections as shown in **Figure 10**.

## 7.2 Level of Service Analysis

Using SimTraffic simulation software (for signalized and unsignalized intersections) and SIDRA software (for the roundabout) and the HCM 6 delay thresholds provided in the Introduction, opening year 2024 plus project Saturday AM and PM peak hour LOS were computed for each study intersection. The results of the analysis are reported in **Table 10** (see Appendix for the detailed LOS report).

**Table 10: Opening Year 2024 plus Project Conditions Saturday AM & PM Peak Hour Level of Service**

Intersection				Worst Movement <sup>1</sup>			Overall Intersection <sup>2</sup>	
ID	Location	Period	Control	Movement <sup>3</sup>	Delay Sec/Veh	LOS	Avg. Delay Sec/Veh	LOS
1	Doe Pass Rd / Deer Valley Dr East	AM	Signal	-	-	-	2	A
		PM		-	-	-	2	A
2	Doe Pass Rd / Deer Valley Dr West	AM	SSSC <sup>4</sup>	NB Left	10	B	-	-
		PM		NB Left	15	B	-	-
3	Queen Esther Dr / Deer Valley Dr East	AM	SSSC	WB Left	7	A	-	-
		PM		WB Left	10	B	-	-
4	Deer Valley Dr East / Solamere Dr	AM	SSSC	SB Left	8	A	-	-
		PM		SB Left	12	B	-	-
5	Deer Valley Dr / Deer Valley Dr East / Deer Valley Dr West	AM	SSSC	WB Left	13	B	-	-
		PM		WB Right	<b>74</b>	<b>F</b>	-	-
6	Deer Valley Drive / Marsac Avenue	AM	Roundabout	-	-	-	13	B
		PM		-	-	-	14	B
7	Deer Valley Dr / Bonanza Dr	AM	Signal	-	-	-	12	B
		PM		-	-	-	24	C
8	Deer Valley Dr / Park Ave / Empire Ave	AM	Signal	-	-	-	<b>79</b>	<b>E</b>
		PM		-	-	-	<b>88</b>	<b>F</b>
9	Bonanza Dr / Monitor Dr / SR-248	AM	Signal	-	-	-	13	B
		PM		-	-	-	21	C

Notes:

**Bold text** indicates intersections operating below Park City's acceptable LOS threshold.

1. This represents the worst approach LOS and delay (seconds/vehicle) and is only reported for unsignalized intersections.
2. This represents the overall intersection LOS and delay (seconds/vehicle).
3. NB=Northbound, SB=Southbound, EB=Eastbound, WB=Westbound
4. Side-street stop control.

Source: Fehr & Peers.





As shown in **Table 10**, all study intersections operated within acceptable LOS (LOS C or better), with the exception of the following locations:

- Deer Valley Drive East / Deer Valley Drive West: LOS F in the PM peak hour
  - This is caused by the high traffic volumes exiting the Deer Valley Resort area making a westbound right turn onto Deer Valley Drive. The westbound approach is stop-controlled, making it difficult for vehicles to find a gap and turn onto Deer Valley Drive West.
- Deer Valley Drive / Park Avenue / Empire Avenue: LOS E in the AM peak hour, LOS F in the PM peak hour
  - This is caused by high congestion at the signal due to high volumes accessing various ski resorts and downtown Park City

It should be noted that the proposed Snow Park Village development introduces various support land uses intended to attract resort users to stay on-site after the ski resort peak hour. This will help distribute the peaking of traffic, reducing delays at the study intersections and roadways. Therefore, the results shown in **Table 10** are likely overstated.

## 7.3 Mitigation Measures

The Snow Park Village site plan includes realignment of the Deer Valley Drive / Deer Valley Drive East / Deer Valley Drive West intersection. The intersection is currently a “T”-intersection with free-flow movement north/south along Deer Valley Drive West / Deer Valley Drive, and a stop-control on the approach of Deer Valley Drive East. The proposed re-alignment allows free-flow movement east/west along Deer Valley Drive East and stop-control on the northbound approach on Deer Valley Drive West, as shown in **Figure 8**. Deer Valley Drive West will serve as a primary transit and auto route to access the proposed transit hub and the main P2 parking level entrance on Doe Pass Road, and serve private vehicles accessing Royal Street and the Trail’s End community. Deer Valley Drive East will serve as the secondary vehicular route to access the Snow Park drop-off/pick-up area and parking structure accesses that includes day skier spaces, hotel, and residences.

To account for this shift in traffic on Deer Valley Drives East and West stemming from intersection realignment, proposed wayfinding, and the placement of site access along Deer Valley Drive East, analyses presented in this report assume that roughly 45% of the total traffic would use Deer Valley Drive East and roughly 55% of the total traffic would use Deer Valley Drive West inbound in the AM peak hour, and roughly 90% of the traffic would use Deer Valley Drive East and roughly 10% of the traffic would use Deer Valley



Drive West outbound in the PM peak hour. This yields conservative results with regards to changes in travel behavior and will rely on various on- and off-site improvements to be realistically achieved. Background traffic was shifted and modified to account for the proposed shift in circulation.

Park City has a longstanding position of not mitigating certain deficient intersections within its boundaries due to the impacts of road widening and other potential mitigations to the community. As a result, potential mitigations at the intersections of Deer Valley Drive / Park Avenue / Empire Avenue, Bonanza Drive / Monitor Drive / SR-248 were not analyzed as part of this study, and are therefore not included as recommendations. Further, deficiencies shown at the intersection of Deer Valley Drive / Bonanza Drive are not a result of project-generated trips or operations of the intersection itself; instead they stem from vehicle queues from the intersection of Deer Valley Drive / Park Avenue / Empire Avenue. As a result, mitigations at the intersection of Deer Valley Drive / Bonanza Drive are not recommended as part of this study. As stated earlier, Deer Valley Drive between the roundabout and SR-224 intersection is a UDOT facility. Any efforts to improve traffic will be led by UDOT.

The analysis results with the reconfigured Deer Valley Drive East / Deer Valley Drive West intersection are shown in **Table 11** (see Appendix for the detailed LOS report). As shown in **Table 11**, the Deer Valley Drive / Deer Valley Drive East / Deer Valley Drive West intersection operates at LOS B and LOS C in the AM and PM peak hour, respectively.

With the redistributed traffic due to the proposed circulation, the Deer Valley Drive East / Solamere Drive intersection now operates at LOS E in the PM peak hour. A sensitivity analysis (described later in Section 11.1.2.1 of this report) indicated that there are no issues at this location during non-peak conditions. However, it is recommended that this location be monitored and determine if further traffic control is needed when warranted to improve traffic flow and safety. During periods of peak traffic, Deer Valley will work with City staff to implement manual traffic controls at the Deer Valley Drive East / Solamere Drive intersection.

**Table 11: Opening Year 2024 plus Project Mitigated Conditions Saturday AM & PM Peak Hour Level of Service**

Intersection				Worst Movement <sup>1</sup>			Overall Intersection <sup>2</sup>	
ID	Location	Period	Control	Movement <sup>3</sup>	Delay Sec/Veh	LOS	Avg. Delay Sec/Veh	LOS
1	Doe Pass Rd / Deer Valley Dr East	AM	Signal	-	-	-	2	A
		PM		-	-	-	3	A
2	Doe Pass Rd / Deer Valley Dr West	AM	SSSC <sup>4</sup>	NB Left	6	A	-	-
		PM		NB Left	5	A	-	-
3	Queen Esther Dr / Deer Valley Dr East	AM	SSSC	WB Left	9	A	-	-
		PM		WB Left	24	C	-	-
4	Deer Valley Dr East / Solamere Dr	AM	SSSC	SB Left	8	A	-	-
		PM		SB Left	<b>49</b>	<b>E</b>	-	-
5	Deer Valley Dr / Deer Valley Dr East / Deer Valley Dr West	AM	SSSC	WB Left	10	B	-	-
		PM		WB Left	18	C	-	-
6	Deer Valley Drive / Marsac Avenue	AM	Roundabout	-	-	-	13	B
		PM		-	-	-	14	B
7	Deer Valley Dr / Bonanza Dr	AM	Signal	-	-	-	12	B
		PM		-	-	-	30	C
8	Deer Valley Dr / Park Ave / Empire Ave	AM	Signal	-	-	-	<b>81</b>	<b>F</b>
		PM		-	-	-	<b>86</b>	<b>F</b>
9	Bonanza Dr / Monitor Dr / SR-248	AM	Signal	-	-	-	14	B
		PM		-	-	-	22	C

Notes:

**Bold text** indicates intersections operating below Park City's acceptable LOS threshold.

1. This represents the worst approach LOS and delay (seconds/vehicle) and is only reported for unsignalized intersections.

2. This represents the overall intersection LOS and delay (seconds/vehicle).

3. NB=Northbound, SB=Southbound, EB=Eastbound, WB=Westbound

Source: Fehr & Peers.

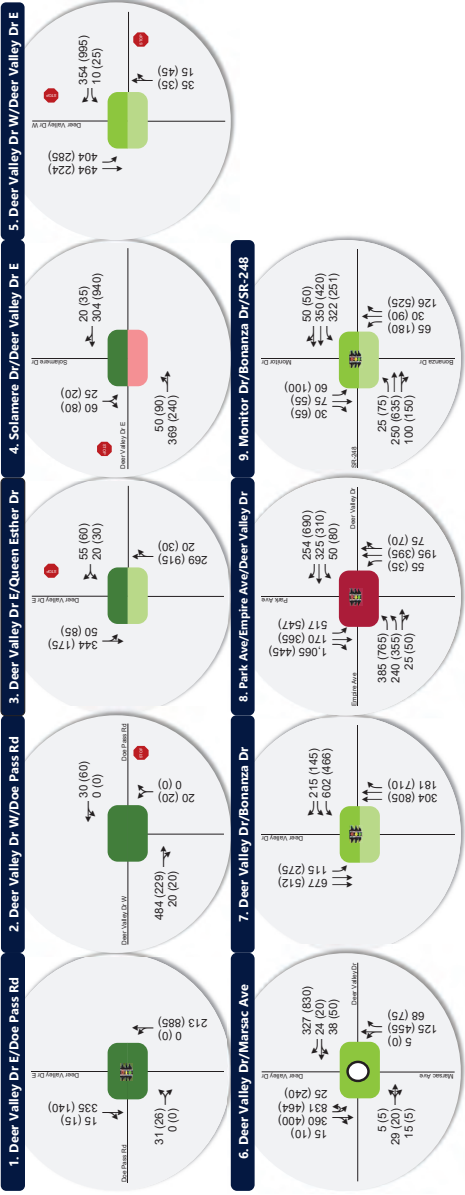

**LEGEND**

- Stop Sign
- Signalized
- Roundabout
- Lane Configuration
- Peak Hour Traffic Volume per lane
- Intersection Level of Service (LOS):
  - A
  - B
  - C
  - D
  - E
  - F

Figure 10

Opening Year 2024 Plus Project Saturday AM & PM Peak Hour Traffic Conditions

## 8. Future 2040 Background Conditions

The purpose of the future 2040 background conditions analysis is to evaluate the study intersections during peak travel periods under projected 2040 traffic volumes. This analysis provides a baseline condition for the year 2040, which can be used to determine future project impacts.

### 8.1 Traffic Volumes

Traffic volumes for 2040 were estimated using traffic counts and forecasted volumes from the Summit/Wasatch Travel Demand Model (September 2020 version) for 2040. The Summit/Wasatch Travel Demand Model shows a lower growth rate in the future by accounting for a higher mode split of transportation – higher usage of transit, walking, and biking than previous versions of travel demand models. The following growth rates used on the following roadways to project 2040 background weekday volumes as shown in **Figure 11**.

- 0.3% on Deer Valley Drive (SR-224) north of Bonanza Drive
- 0.7% on Deer Valley Drive (SR-224) south of Bonanza Drive
- 0.6% on Deer Valley Drive (SR-224) north of Marsac Avenue
- 0.9% on Deer Valley Drive (SR-224) east of Marsac Avenue
- 1.0% on Deer Valley Drive (SR-224) north of Deer Valley Drive West
- 0.8% on Deer Valley Drive (SR-224) south of Deer Valley Drive West
- 1.2% on Bonanza Drive
- 0.4% on Marsac Avenue

Based on the understanding that much of the lower Deer Valley is effectively built out, traffic volumes on Solamere Drive and Queen Esther Drive were not increased for future scenarios.

### 8.2 Level of Service Analysis

Using SimTraffic simulation software (for signalized and unsignalized intersections) and SIDRA software (for the roundabout) and the HCM 6 delay thresholds provided in the Introduction, future 2040 background weekday peak hour LOS was computed for each study intersection. The results of this analysis for the AM & PM peak hour are reported in **Table 12** (see Appendix for the detailed LOS report).



**Table 12: Future 2040 Background Conditions Saturday AM & PM Peak Hour Level of Service**

Intersection				Worst Movement <sup>1</sup>			Overall Intersection <sup>2</sup>	
ID	Location	Period	Control	Movement <sup>3</sup>	Delay Sec/Veh	LOS	Avg. Delay Sec/Veh	LOS
1	Doe Pass Rd / Deer Valley Dr East	AM	SSSC <sup>4</sup>	-	-	-	-	-
		PM		-	-	-	-	-
2	Doe Pass Rd / Deer Valley Dr West	AM	SSSC	-	-	-	-	-
		PM		-	-	-	-	-
3	Queen Esther Dr / Deer Valley Dr East	AM	SSSC	WB Left	7	A	-	-
		PM		WB Left	9	A	-	-
4	Deer Valley Dr East / Solamere Dr	AM	SSSC	SB Left	8	A	-	-
		PM		SB Left	15	C	-	-
5	Deer Valley Dr / Deer Valley Dr East / Deer Valley Dr West	AM	SSSC	WB Left	17	C	-	-
		PM		WB Right	<b>112</b>	<b>F</b>	-	-
6	Deer Valley Drive / Marsac Avenue	AM	Roundabout	-	-	-	16	C
		PM		-	-	-	11	B
7	Deer Valley Dr / Bonanza Dr	AM	Signal	-	-	-	18	B
		PM		-	-	-	<b>59</b>	<b>E</b>
8	Deer Valley Dr / Park Ave / Empire Ave	AM	Signal	-	-	-	<b>83</b>	<b>F</b>
		PM		-	-	-	<b>90</b>	<b>F</b>
9	Bonanza Dr / Monitor Dr / SR-248	AM	Signal	-	-	-	16	B
		PM		-	-	-	28	C

Notes:

**Bold text** indicates intersections operating below Park City's acceptable LOS threshold.

1. This represents the worst approach LOS and delay (seconds/vehicle) and is only reported for unsignalized intersections.
2. This represents the overall intersection LOS and delay (seconds/vehicle) and is only reported for signalized intersections and roundabouts.
3. NB=Northbound, SB=Southbound, EB=Eastbound, WB=Westbound
4. Side-street stop control.

Source: Fehr & Peers.

As shown in **Table 12**, all study intersections operated within acceptable LOS (LOS C or better), with the exception of the following locations:

- Deer Valley Drive East / Deer Valley Drive West: LOS F in the PM peak hour
  - This is caused by the high volumes of vehicles exiting the Deer Valley Resort area making a westbound right turn onto Deer Valley Drive West. The westbound approach is stop-



controlled, making it difficult for vehicles to find a gap and turn onto Deer Valley Drive West.

- Deer Valley Drive / Bonanza Drive: LOS E in the PM peak hour
  - This is caused by vehicle queues spilling back to this intersection from the upstream intersection at Deer Valley Drive / Park Avenue / Empire Avenue.
- Deer Valley Drive / Park Avenue / Empire Avenue: LOS F in both AM and PM peak hours
  - This is caused by high congestion at the signal due to high volumes accessing various ski resorts and downtown Park City.

## 8.3 Mitigation Measures

The site plan for the concept master plan for Snow Park Village shows re-alignment of the Deer Valley Drive East / Deer Valley Drive West intersection, which will alter the westbound LOS at this intersection. Therefore, Fehr & Peers does not recommend any mitigation measures for future 2040 background conditions.

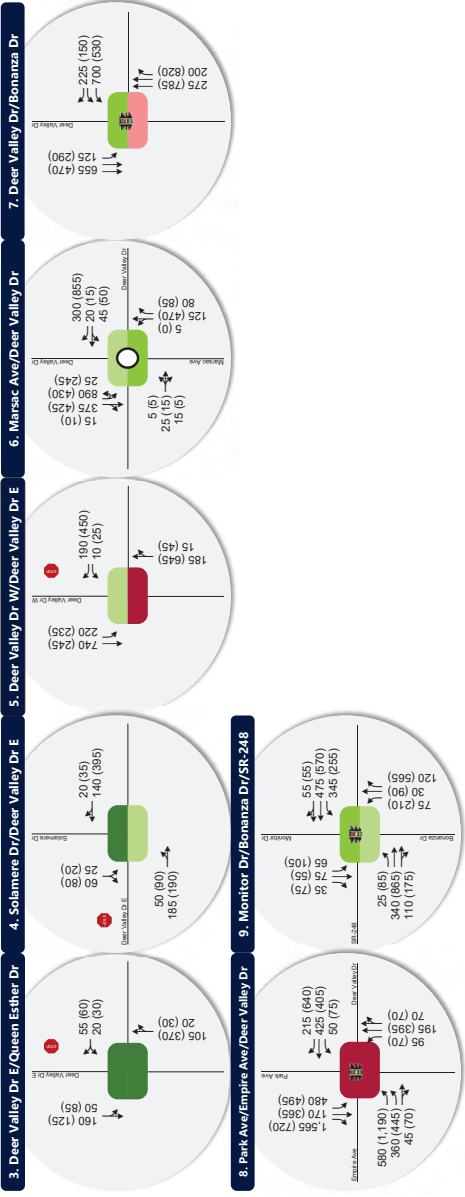

**LEGEND**

- Stop Sign
- Signalized
- Roundabout
- Lane Configuration
- Peak Hour Traffic Volume per lane
- Intersection Level of Service (LOS):
  - A
  - B
  - C
  - D
  - E
  - F
- AM
- PM



Figure 11  
 Future 2040 Background Saturday AM & PM Peak hour Traffic Conditions

## 9. Future 2040 plus Project Conditions

### 9.1 Purpose

The purpose of the future 2040 plus project conditions analysis is to evaluate the impact of the proposed development traffic on the surrounding roadway network in the year 2040. To analyze this impact, the projected 2040 Saturday AM and PM peak hour background traffic volumes were combined with volumes generated by the conceptual development for the Saturday AM and PM peak hours. Intersection LOS analyses were then performed and compared to the results of the background traffic volumes. This comparison shows the impact of the conceptual project in 2040.

### 9.2 Traffic Volumes

Project-generated traffic (**Figure 7**) was added to the future 2040 background volumes (**Figure 11**) to yield “future 2040 plus project” Saturday AM and PM peak hour traffic volumes at the study intersections as shown in **Figure 12**.

### 9.3 Level of Service Analysis

Using SimTraffic simulation software (for signalized and unsignalized intersections) and SIDRA software (for the roundabout) and the HCM 6 delay thresholds provided in the Introduction, future 2040 plus project Saturday AM and PM peak hour LOS were computed for each study intersection for the conceptual site development. The results of the analysis are reported in **Table 13** (see Appendix for the detailed LOS report).

**Table 13: Future 2040 plus Project Conditions Saturday AM & PM Peak Hour Level of Service**

Intersection				Worst Movement <sup>1</sup>			Overall Intersection <sup>2</sup>	
ID	Location	Period	Control	Movement <sup>3</sup>	Delay Sec/Veh	LOS	Avg. Delay Sec/Veh	LOS
1	Doe Pass Rd / Deer Valley Dr East	AM	Signal	-	-	-	2	A
		PM		-	-	-	2	A
2	Doe Pass Rd / Deer Valley Dr West	AM	SSSC <sup>4</sup>	NB Left	10	B	-	-
		PM		NB Left	16	C	-	-
3	Queen Esther Dr / Deer Valley Dr East	AM	SSSC	WB Left	7	A	-	-
		PM		WB Right	>300	F	-	-
4	Deer Valley Dr East / Solamere Dr	AM	SSSC	SB Left	8	A	-	-
		PM		SB Left	>300	F	-	-
5	Deer Valley Dr / Deer Valley Dr East / Deer Valley Dr West	AM	SSSC	WB Left	33	D	-	-
		PM		WB Right	135	F	-	-
6	Deer Valley Drive / Marsac Avenue	AM	Roundabout	-	-	-	20	C
		PM		-	-	-	11	B
7	Deer Valley Dr / Bonanza Dr	AM	Signal	-	-	-	15	B
		PM		-	-	-	97	F
8	Deer Valley Dr / Park Ave / Empire Ave	AM	Signal	-	-	-	82	F
		PM		-	-	-	90	F
9	Bonanza Dr / Monitor Dr / SR-248	AM	Signal	-	-	-	17	B
		PM		-	-	-	32	C

Notes:

**Bold text** indicates intersections operating below Park City's acceptable LOS threshold.

1. This represents the worst approach LOS and delay (seconds/vehicle) and is only reported for unsignalized intersections.
2. This represents the overall intersection LOS and delay (seconds/vehicle).
3. NB=Northbound, SB=Southbound, EB=Eastbound, WB=Westbound
4. Side-street stop control.

Source: Fehr & Peers.

As shown in **Table 13**, all study intersections operated within acceptable LOS (LOS C or better), with the exception of the following locations:

- Queen Esther Drive / Deer Valley Drive East: LOS F in the PM peak hour
  - This is caused by the vehicles attempting to turn left into Queen Esther Drive, trying to find a gap in the opposing traffic of vehicles exiting Deer Valley.





- Deer Valley Drive East / Solamere Drive: LOS F in the Pm peak hour
  - This is caused by the vehicles attempting to turn left into Solamere Drive, trying to find a gap in the opposing traffic of vehicles exiting Deer Valley.
- Deer Valley Drive East / Deer Valley Drive West: LOS D in the AM peak hour and LOS F in the PM peak hour
  - This is caused by the high volumes of vehicles exiting the Deer Valley Resort area making a westbound right turn onto Deer Valley Drive West. The westbound approach is stop-controlled, making it difficult for vehicles to find a gap and turn onto Deer Valley Drive West.
- Deer Valley Drive / Bonanza Drive: LOS F in the PM peak hour
  - This is caused by vehicle queues spilling back to this intersection from the upstream intersection at Deer Valley Drive / Park Avenue / Empire Avenue.
- Deer Valley Drive / Park Avenue / Empire Avenue: LOS F in both AM and PM peak hours
  - This is caused by congestion at the signal due to high volumes accessing various ski resorts and downtown Park City.

It should be noted that the proposed Snow Park Village development introduces various support land uses intended to attract resort users to stay on-site after the ski resort peak hour. This will help distribute the peaking of traffic, reducing delays at the study intersections and roadways. Therefore, the results shown in **Table 13** are likely overstated.

## 9.4 Mitigation Measures

The Snow Park Village site plan includes realignment of the Deer Valley Drive / Deer Valley Drive East / Deer Valley Drive West intersection. The intersection is currently a "T"-intersection with free-flow movement north/south along Deer Valley Drive West / Deer Valley Drive, and a stop-control on the approach of Deer Valley Drive East. The proposed re-alignment allows free-flow movement east/west along Deer Valley Drive East and stop-control on the northbound approach on Deer Valley Drive West, as shown in **Figure 8**. Deer Valley Drive West will serve as a primary transit and auto route to access the proposed transit hub and the main P2 parking level entrance on Doe Pass Road and serve private vehicles accessing Royal Street and the Trail's End community. Deer Valley Drive East will serve as the secondary vehicular route to access the Snow Park drop-off/pick-up area and parking structure accesses that includes day skier spaces, hotel, and residences.



To account for this shift in traffic on Deer Valley Drives East and West stemming from intersection realignment, proposed wayfinding, and the placement of site access along Deer Valley Drive East, analyses presented in this report assume that roughly 45% of the total traffic would use Deer Valley Drive East and roughly 55% of the total traffic would use Deer Valley Drive West inbound in the AM peak hour, and roughly 90% of the traffic would use Deer Valley Drive East and roughly 10% of the traffic would use Deer Valley Drive West outbound in the PM peak hour. This yields conservative results with regards to changes in travel behavior and will rely on various on- and off-site improvements to be realistically achieved. Background traffic was shifted and modified to account for the proposed shift in circulation.

Park City has a longstanding position of not mitigating certain deficient intersections within its boundaries due to the impacts of road widening and other potential mitigations to the community. As a result, potential mitigations at the intersections of Deer Valley Drive / Park Avenue / Empire Avenue, Bonanza Drive / Monitor Drive / SR-248 were not analyzed as part of this study and are therefore not included as recommendations. Further, deficiencies shown at the intersection of Deer Valley Drive / Bonanza Drive are not a result of project-generated trips or operations of the intersection itself; instead they stem from vehicle queues from the intersection of Deer Valley Drive / Park Avenue / Empire Avenue. As a result, mitigations at the intersection of Deer Valley Drive / Bonanza Drive are not recommended as part of this study. As stated earlier, Deer Valley Drive between the roundabout and SR-224 intersection is a UDOT facility. Any efforts to improve traffic will be led by UDOT.

The analysis results with the reconfigured Deer Valley Drive East / Deer Valley Drive West intersection are shown in **Table 14** (see Appendix for the detailed LOS report). As shown in **Table 14**, the Deer Valley Drive / Deer Valley Drive East / Deer Valley Drive West intersection operates at LOS B and LOS D in the AM and PM peak hour, respectively.

With the redistributed traffic due to the proposed circulation, the Queen Esther Drive / Deer Valley Drive East and Deer Valley Drive East / Solamere Drive intersections still operate at LOS F in the PM peak hour. A sensitivity analysis (described later in Section 11.1.2.1 of this report) indicated that there are no issues at this location during non-peak conditions. However, it is recommended that this location be monitored and determine if further traffic control is needed when warranted to improve traffic flow and safety. During periods of peak traffic, Deer Valley will work with City staff to implement manual traffic controls at the Deer Valley Drive East / Solamere Drive intersection.

**Table 14: Future 2040 plus Project Mitigated Conditions Saturday AM & PM Peak Hour Level of Service**

Intersection				Worst Movement <sup>1</sup>			Overall Intersection <sup>2</sup>	
ID	Location	Period	Control	Movement <sup>3</sup>	Delay Sec/Veh	LOS	Avg. Delay Sec/Veh	LOS
1	Doe Pass Rd / Deer Valley Dr East	AM	Signal	-	-	-	2	A
		PM		-	-	-	4	A
2	Doe Pass Rd / Deer Valley Dr West	AM	SSSC <sup>4</sup>	NB Left	10	B	-	-
		PM		NB Left	6	A	-	-
3	Queen Esther Dr / Deer Valley Dr East	AM	SSSC	WB Left	13	B	-	-
		PM		WB Left	<b>54</b>	<b>F</b>	-	-
4	Deer Valley Dr East / Solamere Dr	AM	SSSC	SB Left	15	C	-	-
		PM		SB Left	<b>155</b>	<b>F</b>	-	-
5	Deer Valley Dr / Deer Valley Dr East / Deer Valley Dr West	AM	SSSC	WB Left	18	C	-	-
		PM		WB Left	<b>31</b>	<b>D</b>	-	-
6	Deer Valley Drive / Marsac Avenue	AM	Roundabout	-	-	-	20	C
		PM		-	-	-	11	B
7	Deer Valley Dr / Bonanza Dr	AM	Signal	-	-	-	24	C
		PM		-	-	-	<b>87</b>	<b>F</b>
8	Deer Valley Dr / Park Ave / Empire Ave	AM	Signal	-	-	-	<b>83</b>	<b>F</b>
		PM		-	-	-	<b>90</b>	<b>F</b>
9	Bonanza Dr / Monitor Dr / SR-248	AM	Signal	-	-	-	15	B
		PM		-	-	-	31	C

Notes:

**Bold text** indicates intersections operating below Park City's acceptable LOS threshold.

1. This represents the worst approach LOS and delay (seconds/vehicle) and is only reported for unsignalized intersections.

2. This represents the overall intersection LOS and delay (seconds/vehicle).

3. NB=Northbound, SB=Southbound, EB=Eastbound, WB=Westbound

Source: Fehr & Peers.

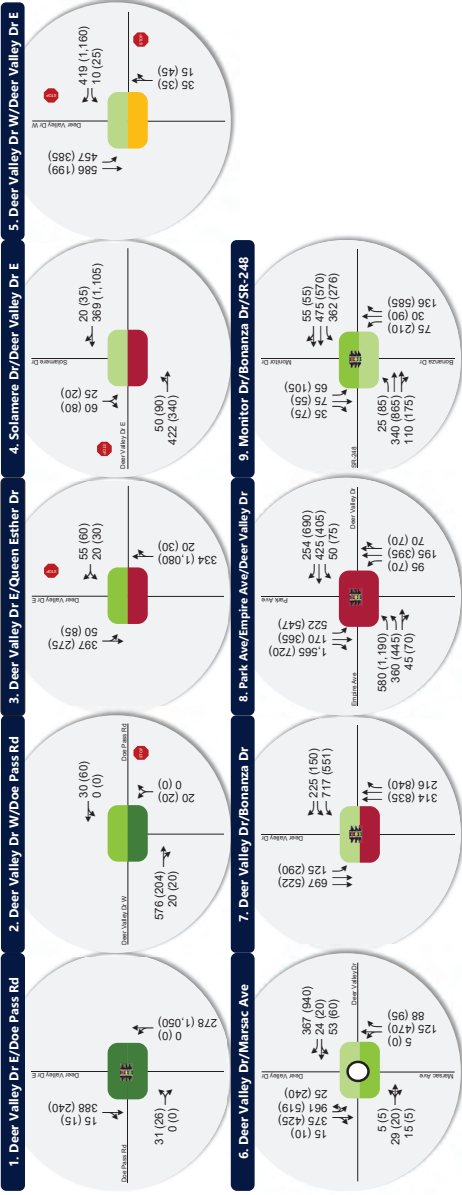

**LEGEND**

- Stop Sign
- Signalized
- Roundabout
- Lane Configuration
- Peak Hour Traffic Volume per lane
- Intersection Level of Service (LOS): A, B, C, D, E, F
- AM, PM



Figure 12  
 Future 2040 Plus Project Saturday AM & PM Peak Hour Traffic Conditions

# 10. Roadway Analysis

The purpose of the roadway analysis is to document the Saturday peak hour roadway volumes to determine the LOS of the internal project roadways.

## 10.1 Analysis Results

The roadway LOS was calculated based on planning level generalized peak hour two-way volumes for roadway capacities, as shown in **Table 15**. These volumes are published by the Florida Department of Transportation (FDOT) based on planning applications of the HCM and are widely used for planning level evaluation of roadway capacity. **Table 15** shows the peak hour two-way capacity estimates for a 2-lane roadway in areas over 5,000 population not in urbanized areas.

**Table 15: Roadway Level of Service Peak Hour Two-Way Traffic Thresholds**

Level of Service	Peak Hour Traffic Capacity Estimates
	2 Lanes
LOS B or better	≤ 820
LOS C	821 – 1,550
LOS D	1,551 – 2,190
LOS E or worse	> 2,190

Source: Fehr & Peers, based on FDOT Generalized Peak Hour Two-Way Volumes for areas over 5,000 not in urbanized areas.

As stated previously, the concept master plan for Snow Park Village shows Deer Valley Drive West as the primary inbound vehicular route, and Deer Valley Drive East as the primary outbound vehicular route. The same assumption used for previous analyses (45% of total traffic using Deer Valley Drive East and 55% of total traffic using Deer Valley Drive West for inbound AM peak, and 90% of total traffic using Deer Valley Drive East and 10% of total traffic using Deer Valley Drive West for outbound PM peak) were applied for the roadway volumes. **Table 16** shows the peak hour roadway LOS analysis for each scenario. As shown in **Table 16**, all internal roadways are expected to operate at LOS C or better with the current 2-lane configuration for all scenarios, with the exception of Deer Valley Drive East in 2040 plus project conditions in the PM peak hour (70 vehicles over the LOS C threshold). Roadway widening on Deer Valley Drive East is not recommended, especially with the alternative option of Deer Valley Drive West, which has more than sufficient capacity.





**Table 16: Snow Park Village Roadway LOS Analysis Summary**

Scenario	Saturday Peak Hour	Deer Valley Dr W (South of Y-Intersection)		Deer Valley Dr E (East of Y-Intersection)	
		Two-Way Volume <sup>1</sup>	LOS	Two-Way Volume <sup>1</sup>	LOS
Existing	AM	650	A/B	400	A/B
	PM	800	A/B	620	A/B
Existing plus Project	AM	550	A/B	770	A/B
	PM	320	A/B	1,330	C
Opening Year 2024 plus Project	AM	560	A/B	790	A/B
	PM	330	A/B	1,350	C
Future 2040 plus Project	AM	650	A/B	910	C
	PM	310	A/B	1,620	D

1. Rounded up to the nearest 10.  
Source: Fehr & Peers.

Existing roadway count sheets are included in the Appendix.

# 11. Site Circulation Analysis

The January 2022 Transportation Analysis reported conditions at external intersections, as well as the two proposed intersections on Doe Pass Road at Deer Valley Drive East and Deer Valley Drive West, which were analyzed in SimTraffic simulation software and SIDRA software. Furthermore, microsimulation analysis was conducted to evaluate on-site circulation as part of the proposed Snow Park Village. Due to the limitations of SimTraffic software in evaluating multimodal conditions and garage access operations, VISSIM microsimulation software was used for on-site circulation analysis.

## 11.1.1 Conditions and Assumptions

The parameters described below were used for analysis as assumptions in the VISSIM model:

### 11.1.1.1 Volumes

The following high-level assumptions were used to assign volumes to individual driveways and approach routing:

- 2040 Peak-hour volumes as presented in Section 9 of this study
- Trip generation as presented in Section 4 of this study
- Assumed roughly 55%/45% split of traffic using Deer Valley Drive West versus Deer Valley Drive East inbound in the AM peak hour
- Assumed roughly 10%/90% split of traffic using Deer Valley Drive West versus Deer Valley Drive East outbound in the PM peak hour
- Proportion of parking supply by garage level

The assumed intersection and driveway volumes are shown in **Figure 13**. Note that the lane configurations shown on the figure reflect proposed conditions, except for at the P2 and P3 garage accesses, which are proposed to have flex lanes that can be ingress or egress, depending on the peak hour and volume demand.

### 11.1.1.2 Parking Garage Gate Transaction

Based on input received from WGI, the parking garage design and operations consultant, the following parking garage gate transaction times were assumed in the model:

- Average of 6 seconds/vehicle for entry
- Average of 14 seconds/vehicle for exit

### 11.1.1.3 Pick-up/Drop-off

The following assumptions were made for the model regarding the proposed new pick-up/drop-off loop in front of Snow Park Lodge at the southern terminus of Deer Valley Drive East:

- 200 vehicles were allocated to use the pick-up/drop-off in both AM and PM peak hours
  - 100 vehicles as pick-up/drop-off
  - 50 vehicles as Transportation Network Company (TNC) users
  - 50 vehicles as Valet users
- The dwell time for the pick-up/drop-off users were modeled ranging between 90 seconds and 180 seconds

### 11.1.1.4 Other Considerations

To evaluate conditions under the most conservative analysis scenario, 2040 weekend AM and PM peak hours were analyzed.

## 11.1.2 Analysis Results

Intersection delay, Level of Service (LOS), and queueing results were evaluated in the VISSIM model at the following locations, as shown in **Figure 13**.

1. Doe Pass Road / Deer Valley Drive East
2. Doe Pass Road / Deer Valley Drive West
3. Queen Esther Drive / Deer Valley Drive East
4. Deer Valley Drive East / Solamere Drive
5. Deer Valley Drive East / Deer Valley Drive West
6. Doe Pass Road / P2 Parking Garage Access
7. Doe Pass Road / P1 Parking Garage Access
8. Doe Pass Road / Mobility Hub Entrance
9. Doe Pass Road / Mobility Hub Exit
10. P2 Parking Garage Access / Deer Valley Drive East
11. P3 Parking Garage Access / Deer Valley Drive East
12. P4 Parking Garage Access / Deer Valley Drive East
13. Snow Park Lodge Pick-up/Drop-off

The same analysis methodology (as described in the previous sections) was used for this analysis.



**Table 17** (see Appendix for the detailed LOS reports) below shows the intersection delay and LOS results from the VISSIM simulation model. As shown in **Table 17**, all study intersections operate at acceptable LOS with the exception of the following locations:

- Queen Esther Drive / Deer Valley Drive East: LOS E in the PM peak hour
  - This is caused by the vehicles attempting to turn left into Queen Esther Drive, trying to find a gap in the opposing traffic of vehicles exiting Deer Valley.
- Deer Valley Drive East / Solamere Drive: LOS F in the PM peak hour
  - This is caused by the vehicles attempting to turn left into Solamere Drive, trying to find a gap in the opposing traffic of vehicles exiting Deer Valley.
  - An analysis was conducted to mitigate this LOS deficiency. A sensitivity analysis (described later in Section 11.1.2.1 of this report) indicated that there are no issues at this location during non-peak conditions. However, it is recommended that this location be monitored and determine if further traffic control is needed when warranted to improve traffic flow and safety. During periods of peak traffic, Deer Valley will work with City staff to implement manual traffic controls at the Deer Valley Drive East / Solamere Drive intersection.
- Deer Valley Drive East / Deer Valley Drive West: LOS D in both AM and PM peak hours
  - This is caused by vehicles attempting to exit the intersection for stop controlled movements.

**Table 17: Future 2040 Plus Project Conditions Saturday AM & PM Peak Hour Level of Service Site Circulation Results**

Intersection				Worst Movement <sup>1</sup>			Overall Intersection <sup>2</sup>	
ID	Location	Period	Control	Movement <sup>3</sup>	Delay Sec/Veh	LOS	Avg. Delay Sec/Veh	LOS
1	Doe Pass Rd / Deer Valley Dr East	AM	Signal	-	-	-	6	A
		PM		-	-	-	4	A
2	Doe Pass Rd / Deer Valley Dr West	AM	SSSC <sup>4</sup>	EB Through	14	B	-	-
		PM		NB Left	8	A	-	-
3	Queen Esther Dr / Deer Valley Dr East	AM	SSSC	WB Left	10	B	-	-
		PM		SB Left	<b>49</b>	<b>E</b>	-	-
4	Deer Valley Dr East / Solamere Dr	AM	SSSC	EB Through	13	B	-	-
		PM		EB Left	<b>124</b>	<b>F</b>	-	-
5		AM	SSSC	NB Through	<b>26</b>	<b>D</b>	-	-



	Deer Valley Dr East / Deer Valley Dr West	PM		WB Left	<b>27</b>	<b>D</b>	-	-
6	Doe Pass Rd / P2 Parking	AM	SSSC	EB Right	13	B	-	-
		PM		NB Left	10	B	-	-
7	Doe Pass Rd / P1 Parking	AM	SSSC	NB Right	7	A	-	-
		PM		NB Right	6	A	-	-
8	Doe Pass Rd / Mobility Hub Entrance	AM	SSSC	WB Left	2	A	-	-
		PM		WB Left	1	A	-	-
9	Doe Pass Rd / Mobility Hub Exit	AM	SSSC	NB Left	23	C	-	-
		PM		NB Left	21	C	-	-
10	P2 Parking / Deer Valley Dr East	AM	SSSC	EB Left	10	B	-	-
		PM		EB Left	10	B	-	-
11	P3 Parking / Deer Valley Dr East	AM	SSSC	EB Left	13	B	-	-
		PM		EB Left	10	B	-	-
12	P4 Parking / Deer Valley Dr East	AM	SSSC	EB Left	17	C	-	-
		PM		EB Left	17	C	-	-
13	Snow Park Lodge Pick-up/Drop-off	AM	-	NB Through	14	B	-	-
		PM		NB Through	15	C	-	-

Notes:

**Bold text** indicates intersections operating below Park City's acceptable LOS threshold.

1. This represents the worst approach LOS and delay (seconds/vehicle) and is only reported for side-street stop controlled intersections.
2. This represents the overall intersection LOS and delay (seconds/vehicle) and is only reported for signalized intersections and all-way stop controlled intersections.
3. NB=Northbound, SB=Southbound, EB=Eastbound, WB=Westbound
4. Side-street stop control.

Source: Fehr & Peers.

### 11.1.2.1 Sensitivity Analysis

The results shown above in **Table 17** represent the expected intersection delays and LOS in projected future 2040 conditions for the peak days of the peak ski season, which likely will be experienced several days of the year. It is not standard practice to design intersections and roadways to accommodate for events that occur only several days of the year. A sensitivity analysis was performed to understand what traffic conditions might look like for more typical conditions at the study intersections.

Data of the Deer Valley Resort visitors indicate that there are up to about 30% less vehicles during the weekday compared to the weekend (this assumption takes into account assumed vehicle occupancy, as presented in section 3.6 of this report). A sensitivity analysis was performed in the VISSIM simulation model





with the reduced inbound/outbound traffic on Deer Valley Drive to replicate “typical weekday” conditions. This analysis was only performed for the PM peak hour, which represented the worst-case scenario. Note that this analysis was not based on actual traffic counts, but rather a sensitivity of potential volume reductions.

**Table 18** (see Appendix for the detailed LOS reports) below shows the intersection delay and LOS results from the VISSIM simulation model for the sensitivity analysis. As shown in **Table 18**, all study intersections are expected to operate at acceptable LOS in typical conditions.

As shown in **Table 17** previously, a few intersections are expected to experience delays in peak ski season conditions. However, as shown in **Table 18**, all study intersections are expected to perform at acceptable LOS in more typical conditions. Furthermore, as stated previously, the proposed Snow Park Village development introduces various supportive land uses intended to attract resort users to stay on-site after the ski resort peak hour, helping distribute the peaking of traffic. Therefore, the results shown in **Table 17** are likely overstated.

Taking this into account, and considering it is not standard practice to design for atypical traffic conditions only expected several days of the year, no further mitigations are recommended at the study intersections beyond the proposed circulation plan.

**Table 18: Future 2040 Plus Project Conditions AM & PM Peak Hour Level of Service Site Circulation Results – Weekday Sensitivity**

Intersection				Worst Movement <sup>1</sup>			Overall Intersection <sup>2</sup>	
ID	Location	Period	Control	Movement <sup>3</sup>	Delay Sec/Veh	LOS	Avg. Delay Sec/Veh	LOS
1	Doe Pass Rd / Deer Valley Dr East	PM	Signal	-	-	-	3	A
2	Doe Pass Rd / Deer Valley Dr West	PM	SSSC <sup>4</sup>	NB Left	7	A	-	-
3	Queen Esther Dr / Deer Valley Dr East	PM	SSSC	SB Left	10	B	-	-
4	Deer Valley Dr East / Solamere Dr	PM	SSSC	EB Left	16	C	-	-
5	Deer Valley Dr East / Deer Valley Dr West	PM	SSSC	NB Through	25	C	-	-
6	Doe Pass Rd / P2 Parking	PM	SSSC	NB Left	8	A	-	-
7	Doe Pass Rd / P1 Parking	PM	SSSC	NB Right	6	A	-	-
8	Doe Pass Rd / Mobility Hub Entrance	PM	SSSC	WB Left	0	A	-	-
9	Doe Pass Rd / Mobility Hub Exit	PM	SSSC	NB Left	21	C	-	-
10	P2 Parking / Deer Valley Dr East	PM	SSSC	EB Left	5	A	-	-
11	P3 Parking / Deer Valley Dr East	PM	SSSC	EB Left	11	B	-	-
12	P4 Parking / Deer Valley Dr East	PM	SSSC	EB Left	16	C	-	-
13	Snow Park Lodge Pick-up/Drop-off	PM	-	NB Through	4	A	-	-

Notes:

**Bold text** indicates intersections operating below Park City's acceptable LOS threshold.

1. This represents the worst approach LOS and delay (seconds/vehicle) and is only reported for side-street stop controlled intersections.
2. This represents the overall intersection LOS and delay (seconds/vehicle) and is only reported for signalized intersections and all-way stop controlled intersections.
3. NB=Northbound, SB=Southbound, EB=Eastbound, WB=Westbound
4. Side-street stop control.

Source: Fehr & Peers.

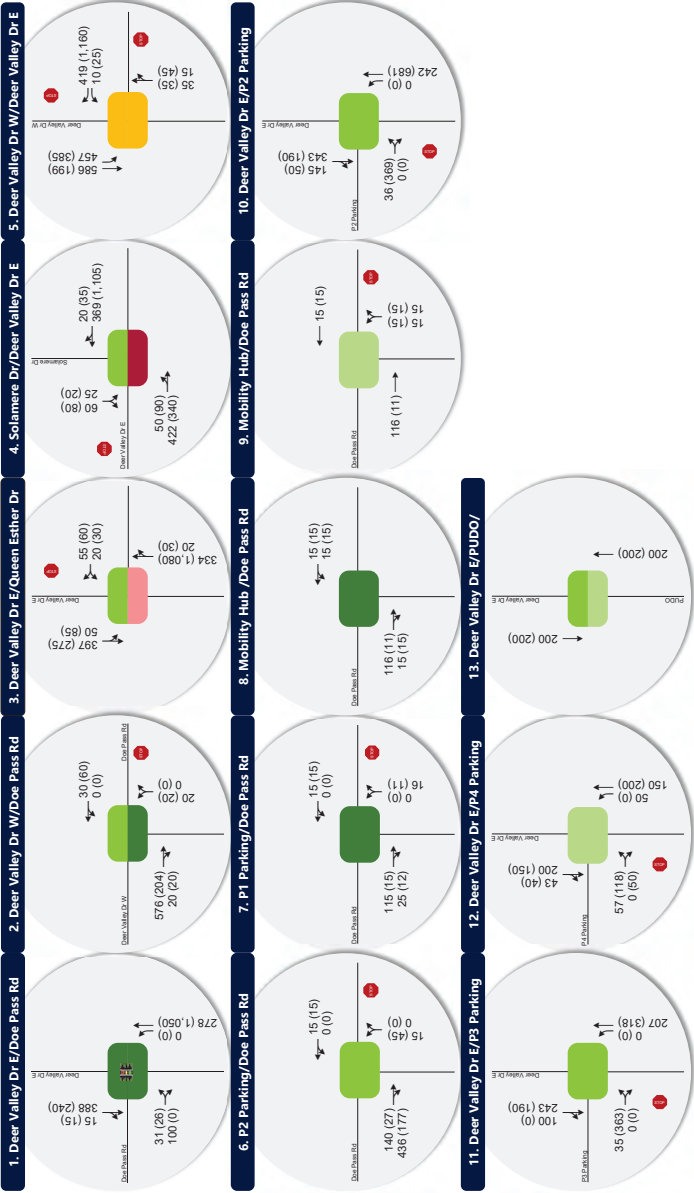

**LEGEND**

- Stop Sign
- Signalized
- Roundabout
- Lane Configuration
- Peak Hour Traffic Volume per lane
- Intersection Level of Service (LOS): A, B, C, D, E, F
- AM, PM

Figure 13  
2040 Site Circulation Analysis Intersection LOS Results



**Table 19** (see Appendix for the detailed queue report) below shows the average maximum queue for each approach at the study intersections. The following lists locations that the average maximum queue is expected to exceed the storage length in the AM peak hour:

- Doe Pass Road / Deer Valley Drive East
  - Eastbound queues occasionally extend past the mobility hub exit. The average queue, however, is 6 feet, and the queue spillback is not expected to be common.
- Doe Pass Road / P2 Parking
  - Eastbound queues occasionally extend past the Doe Pass Road / Deer Valley Drive West intersection. The average queue, however, is 28 feet, and the queue spillback is not expected to be common. This queue is caused by queue spillback beginning at the gate to enter the P2 parking access and the high inbound volumes in the AM peak hour.

The following lists locations that the average maximum queue is expected to exceed the storage length in the PM peak hour:

- Doe Pass Road / Deer Valley Drive East
  - Northbound queues occasionally extend past the P2 Parking Garage Access. The average queue, however, is 19 feet, and the queue spillback is not expected to be a common occurrence.



**Table 19: Future 2040 Plus Project Conditions Saturday AM & PM Peak Hour Queues Site Circulation Analysis**

Intersection			Average Maximum Queues	
ID	Location	Period	Approach <sup>1</sup>	(feet) <sup>2</sup>
1	Doe Pass Rd / Deer Valley Dr East	AM	NB	125
			SB	200
			EB	100
		PM	NB	350
			SB	100
			EB	50
2	Doe Pass Rd / Deer Valley Dr West	AM	NB	50
			EB	225
			WB	0
		PM	NB	25
			EB	25
			WB	0
3	Queen Esther Dr / Deer Valley Dr East	AM	NB	0
			SB	150
			WB	75
		PM	NB	25
			SB	375
			WB	100
4	Deer Valley Dr East / Solamere Dr	AM	SB	100
			EB	125
			WB	25
		PM	SB	100
			EB	750
			WB	50
5	Deer Valley Dr East / Deer Valley Dr West	AM	NB	125
			SB	0
			WB	50
		PM	NB	150
			SB	0
			WB	50
6	Doe Pass Rd / P2 Parking	AM	NB	75





			EB	200
			WB	0
		PM	NB	100
			EB	0
			WB	0
7	Doe Pass Rd / P1 Parking	AM	NB	75
			EB	0
			WB	0
		PM	NB	75
			EB	0
			WB	0
8	Doe Pass Rd / Mobility Hub Entrance	AM	EB	25
			WB	25
		PM	EB	25
			WB	25
9	Doe Pass Rd / Mobility Hub Exit	AM	NB	150
			EB	25
			WB	0
		PM	NB	175
			EB	25
			WB	0
10	P2 Parking / Deer Valley Dr East	AM	NB	0
			SB	25
			EB	100
		PM	NB	25
			SB	0
			EB	125
11	P3 Parking / Deer Valley Dr East	AM	NB	100
			SB	125
			EB	100
		PM	NB	100
			SB	125
			EB	100
12	P4 Parking / Deer Valley Dr East	AM	NB	25
			SB	0



		PM	EB	100
			NB	0
			SB	0
			EB	125
13	Snow Park Lodge Pick-up/Drop-off	AM	NB	100
			SB	25
		PM	NB	100
			SB	25

Notes:

1. NB=Northbound, SB=Southbound, EB=Eastbound, WB=Westbound
2. Rounded up to nearest 25'.

Source: Fehr & Peers.

It should be noted that the LOS results and queue results shown in **Table 17** and **Table 19** capture the delays and queues at the side-streets for vehicles turning onto the major road. However, it does not capture the delays and queues for vehicles experienced at the parking gate due to the assumed transaction time. The VISSIM simulation indicates that with the assumed gate transaction times, vehicles are expected to experience over 100 seconds of delay per vehicle to exit the garage in the PM peak hour, with potentially long internal queues.



Figure 14  
 2040 Site Circulation Analysis Queue Results





## 13. Parking Analysis

A fundamental aspect of the Snow Park Village proposal is the implementation of a constrained, structured parking supply that will require parkers to pay a daily fee. This strategy is seen as a key disincentive to traveling in Park City by single-occupant vehicle, and aligns with the City's broader mobility goals.

### 13.1 Analysis Method

For the shared parking analysis of the updated land use plan, the development is proposed to include 11 buildings which include the following land uses (taken from the land use program dated October 26, 2021):

- 31,000 square feet of ballroom/event center space
- 72 multifamily housing units
- 193 hotel rooms with 4,500 square feet of hotel support uses.
- 26,500 square feet of commercial/retail space

The development is also proposed to include the Deer Valley Ski resort and other land uses in support of the resort. It should be noted that the land uses supporting the ski resort will not be parking generators; rather, the ski resort will be the parking generator, and the support land uses serve as accessories to the resort.

Fehr & Peers applied the methodology outlined in Urban Land Institute's (ULI) *Shared Parking Manual, 3<sup>rd</sup> Edition* and its associated spreadsheet tool, to determine the recommended number of parking spaces at Snow Park Village. The methods outlined in *Shared Parking* are considered national state-of-the-practice for right-sizing parking supplies to be shared by multiple land uses. It provides instruction for reducing parking requirements for mixed use developments.

The ULI manual includes baseline parking rates that are informed by parking counts performed across the United States. While these are generally acceptable in many land use contexts, the baseline ULI parking rates are based on nationwide suburban area parking counts and do not consider the unique travel patterns in the study area, nor the atypical land use context (adjacent to a destination ski resort). Therefore, this analysis was performed using parking rates based on the parking requirements outlined in Park City zoning code.

Fehr & Peers estimated the required number of parking spaces at the development using the following factors:

- Proposed land use characteristics as described in the introduction
- Recommended parking rates from IBI Group which are comparable to Park City Zoning Code minima
- Monthly adjustment factors from *Shared Parking*
- Time-of-day adjustment factors from *Shared Parking*
- Noncaptive ratios (internal capture) rates calculated using ULI's *Shared Parking* spreadsheet tool
- Mode adjustment (walking, biking, transit) rates calculated using ULI's *Shared Parking* spreadsheet tool
- Parking counts at the resort collected during ski season from 2015-2016, 2016-2017, 2018-2019, and 2019-2020
  - These counts showed an average February Saturday parking rate of 1,433 stalls at the resort. This was rounded up to assume 1,500 stalls for day skiers and employees

From the proposed land uses that generate parking demand, and the recommended rates from the Park City zoning code, the minimum required parking supply was calculated to be 2,236 stalls. This however does not account for paid parking (which is proposed in future plans for the parking structure) and shared parking among uses. For the shared parking analysis, a reduction of up to 9% was calculated due to the factors listed above, resulting in a parking supply of 2,041 stalls based on shared parking reductions alone.

A reduction of up to 17% in daily parking demand due to paid parking was calculated using methods derived from *The Price Elasticity of Parking: a Meta-Analysis* (Lehner, Peer; 2018), which evaluates price sensitivities to the implementation of paid parking from 50 separate studies. Given that many Deer Valley guests are likely to be less price sensitive than the general public, this study assumes less reduction in demand due to paid parking. It is worth noting, however, that many day skiers visiting from points along the Wasatch Front are more likely to be influenced by the implementation from paid parking.

This results in a potential reduction of up to 26% in recommended parking due to paid parking and shared parking. For this study, to present a more conservative reduction and resulting parking supply, a 20% reduction was assumed to be applicable due to factors such as existing and proposed land uses and expected growth, and was applied to the base required parking. **Table 20** outlines the number of recommended stalls with the reduction due to paid parking and shared parking. Shared parking calculations are attached in the Appendix.





**Table 20: Snow Park Village Parking Analysis Summary**

Base Recommended Stalls	% Reduction (Paid Parking and Shared Parking)	Stalls Reduced (Paid Parking and Shared Parking)	Net Recommended Stalls
2,236	20%	447	<b>1,789</b>

Source: Fehr & Peers

As shown in **Table 20**, with the expected reductions due to paid parking and shared parking, it is recommended that a minimum of 1,789 stalls be provided for the proposed Snow Park Village development. It should be noted that phasing and ongoing refinement of the land use program may adjust the base parking rates and recommendations.

## 13.2 Parking Management

An effective and efficient parking management system is essential to maintain both a high-quality user experience and to minimize traffic impacts on adjacent roadways. An essential element to improve the efficiency of structured parking is to provide real time information regarding parking availability. In addition to implementing payment technology that expedites vehicle ingress at all driveways, Deer Valley will work with relevant partners to ensure more complete information is available to parkers.

The Snow Park Parking Management Plan is included in **Attachment B**.

## 14. Transit Evaluation

This section includes an evaluation of existing transit service and infrastructure, proposed transit improvements, and description of how the Snow Park Village proposal aligns with Park City's *Transit First* policy.

### 14.1.1 Existing Transit Service

In addition to a multitude of private shuttles and buses, there are two public transit operators providing transit service to and from Deer Valley: Park City Transit and High-Valley Transit. High Valley Transit operates one route that services Deer Valley:

- 101 – Spiro / 224 Local that services Deer Valley.

Park City Transit operates six routes the service Deer Valley:

- 1 Red: Prospector Square – Deer Valley
- 2 Green: Park Meadows/Thaynes Canyon – Deer Valley
- 3 Blue: Thaynes Canyon/Park Meadows – Deer Valley
- 5 Yellow: Prospector Square – Deer Valley
- 40 Bronze: Main Street – Royal Street – Silver Lake Lodge
- 50 Teal: Prospector Square – Deer Valley

Park City Transit Park City Transit is undergoing a short-range service plan update, with potential changes in transit service to and from Deer Valley expected in the coming year.

Local bus stops are provided along both sides of Deer Valley Drive East and Deer Valley Drive West, allowing transit riders to board buses that are Deer Valley- or Old Town-bound. At the southern end of the Deer Valley Drive loop closest to the existing Snow Park base area, there are bi-directional bus stops that can accommodate up to four buses at once. Aside from the existing bi-directional stops at Snow Park, bus stops do not include shelters. Buses providing service to Deer Valley travel in mixed traffic.

## 14.2 Proposed Transit Improvements

A proposed six bus-bay mobility hub at the northeast corner of Snow Park Village will provide a comfortable and appealing transit facility on-site that provides direct access to the project and relocated ski lift bases. The mobility hub will also include accommodations for cyclists and allow for electric bus charging



infrastructure. This mobility hub will allow for increased frequency of transit service which will be essential to incentivizing transit service.

To further support transit service as part of the Snow Park Village proposal, a new traffic signal with transit preemption capabilities is proposed at the Doe Pass Road / Deer Valley Drive East intersection. This will help ensure that transit vehicles accessing and exiting the proposed mobility hub with limited conflicting traffic.

# 15. Transportation Demand Management

Park City, through its ongoing Transportation Master Plan update, has identified the laudable and ambitious goal of reducing vehicle trips by 20% throughout Park City. The City is tackling this challenge through a variety of strategies, including but not limited to the following:

- Updates to the local and regional transit system
- Coordination with partner agencies to implement greater park-and-ride capacity
- Expansion of high-quality active transportation facilities throughout Park City
- Partnerships with private developments to implement and operate comprehensive Transportation Demand Management (TDM) programs

Furthering the City’s broader trip reduction goal, Deer Valley will continue to operate its TDM program, and expand on current offerings, to better align with the adopted PCMC TDM Plan (2016). A high-level summary of the Deer Valley TDM Plan is shown below in **Table 21**.

**Table 21: Deer Valley TDM Measures**

Measure	Status	Description
Transit pass subsidy	Existing Program	Subsidized UTA transit passes for Deer Valley employees living in Salt Lake Valley and Utah Valley
Bicycle Amenities and Perks	New Program	Bicycle repair tools and dedicated bicycle parking at key locations
Education and Promotion	Existing Program	Educational and promotional events to encourage travelers to use by modes other than driving alone.
Parking Management	New Program	Efficient, constrained, and priced parking to discourage drive-alone trips
Employee Transit	Existing Program	Operate designated employee transit to facilitate efficient employee commutes through an appealing alternative until such time as Park City Transit and/or High Valley Transit meets this need



Real-Time Messaging	New Program	Communicate traffic conditions in real time to travelers
Appoint a TDM Coordinator	New Program	Identify a staff member to oversee the TDM program

Source: Fehr & Peers.

## 15.1 TDM Monitoring

As the transportation landscape in Park City and Summit County changes, monitoring the use and effectiveness of Deer Valley’s TDM program will be crucial to its success. In alignment with requests from Park City staff, Deer Valley will implement an annual monitoring program consisting of the following elements:

- One nine day period of vehicle counts at all Snow Park Village driveways, to be analyzed and summarized by a third-party consultant. This data will be analyzed and summarized by a third-party consultant;
- Average vehicle occupancy collected on one weekday and one weekend day, collected by a third-party vendor, to be analyzed and summarized by a third-party consultant;
- Ski season transit ridership, summarized at the stop and daily levels and provided by transit operators, to be analyzed and summarized by a third-party consultant;
- Available data regarding program utilization from the *Ride On Park City* platform, to be analyzed and summarized by a third-party consultant.

Analysis of this data will be submitted in an annual monitoring memorandum for City staff review and will be supported by semiannual coordination meetings with City staff and other major employers in Park City. This monitoring program will be used to enhance program offerings and avoid redundancy of service where public and private options overlap.

The Deer Valley TDM Plan is presented in full in **Attachment C**.





## 16. Conclusion/Recommendations

With proposed mitigations in place, all study intersections at which mitigations are feasible and supported by the community operate at acceptable levels of service under all Plus Project analysis scenarios. Through dedicated transit infrastructure, improved active transportation connections between the Project and Park City's existing active transportation network, a fully reworked parking system, and management of ongoing TDM offerings in addition to new measures, the Snow Park Village proposal aligns with the City's *Transit First* policy by encouraging travel by means other than driving alone.

Implementing a new traffic signal with transit preemption at the intersections of and Doe Pass Road / Deer Valley Drive East will improve traffic operations and support transit. Implementing an off-street, multi-use path around the Deer Valley Drive loop will improve pedestrian and cyclist connectivity adjacent to the project site. Ongoing monitoring of TDM program effectiveness will maintain City-Deer Valley cooperation in pursuit of shared goals.



# Appendix

# L2 Data Collection

L2DataCollection.com  
Idaho (208) 860-7554 Utah (801) 413-2993

Study: FEHR0119  
Intersection: Deer Valley/ Deer Valley N  
City, State: Deer Valley, Utah  
Control: Stop Sign

File Name : Deer Valley Dr & Deer Valley Dr N - D1  
Site Code : Day 1  
Start Date : 2/15/2020  
Page No : 1

### Groups Printed- General Traffic

Start Time	Deer Valley Drive From Northwest				Deer Valley Drive N From East				Deer Valley Drive From Southeast				Int. Total
	Thru	Bear Left	Peds	App. Total	Bear Right	Hard Left	Peds	App. Total	Hard Right	Thru	Peds	App. Total	
07:45 AM	71	123	0	194	19	4	0	23	2	18	0	20	237
Total	71	123	0	194	19	4	0	23	2	18	0	20	237
08:00 AM	110	101	0	211	34	2	0	36	5	21	1	27	274
08:15 AM	124	70	0	194	29	2	0	31	5	26	0	31	256
08:30 AM	117	55	0	172	53	10	0	63	4	29	0	33	268
08:45 AM	125	46	0	171	48	7	0	55	6	32	4	42	268
Total	476	272	0	748	164	21	0	185	20	108	5	133	1066
09:00 AM	111	35	0	146	54	7	0	61	2	31	0	33	240
09:15 AM	94	27	0	121	51	6	0	57	4	31	0	35	213
09:30 AM	77	42	0	119	55	13	0	68	4	43	0	47	234
-----													
Total	282	104	0	386	160	26	0	186	10	105	0	115	687
-----													
03:30 PM	81	47	0	128	67	4	0	71	13	69	0	82	281
03:45 PM	55	50	0	105	81	7	0	88	16	98	3	117	310
Total	136	97	0	233	148	11	0	159	29	167	3	199	591
04:00 PM	66	41	0	107	83	8	0	91	11	130	0	141	339
04:15 PM	46	49	6	101	73	3	0	76	18	155	0	173	350
04:30 PM	46	68	0	114	104	2	0	106	13	109	1	123	343
04:45 PM	54	58	0	112	71	5	0	76	13	91	2	106	294
Total	212	216	6	434	331	18	0	349	55	485	3	543	1326
05:00 PM	42	51	0	93	89	2	0	91	11	95	4	110	294
05:15 PM	30	55	0	85	63	4	0	67	9	78	0	87	239
Grand Total	1249	918	6	2173	974	86	0	1060	136	1056	15	1207	4440
Apprch %	57.5	42.2	0.3		91.9	8.1	0		11.3	87.5	1.2		
Total %	28.1	20.7	0.1	48.9	21.9	1.9	0	23.9	3.1	23.8	0.3	27.2	

# L2 Data Collection

L2DataCollection.com

Idaho (208) 860-7554 Utah (801) 413-2993

Study: FEHR0119  
 Intersection: Deer Valley / Deer Valley N  
 City, State: Deer Valley, Utah  
 Control: Stop Sign

File Name : Deer Valley Dr & Deer Valley Dr N - D1  
 Site Code : Day 1  
 Start Date : 2/15/2020  
 Page No : 2

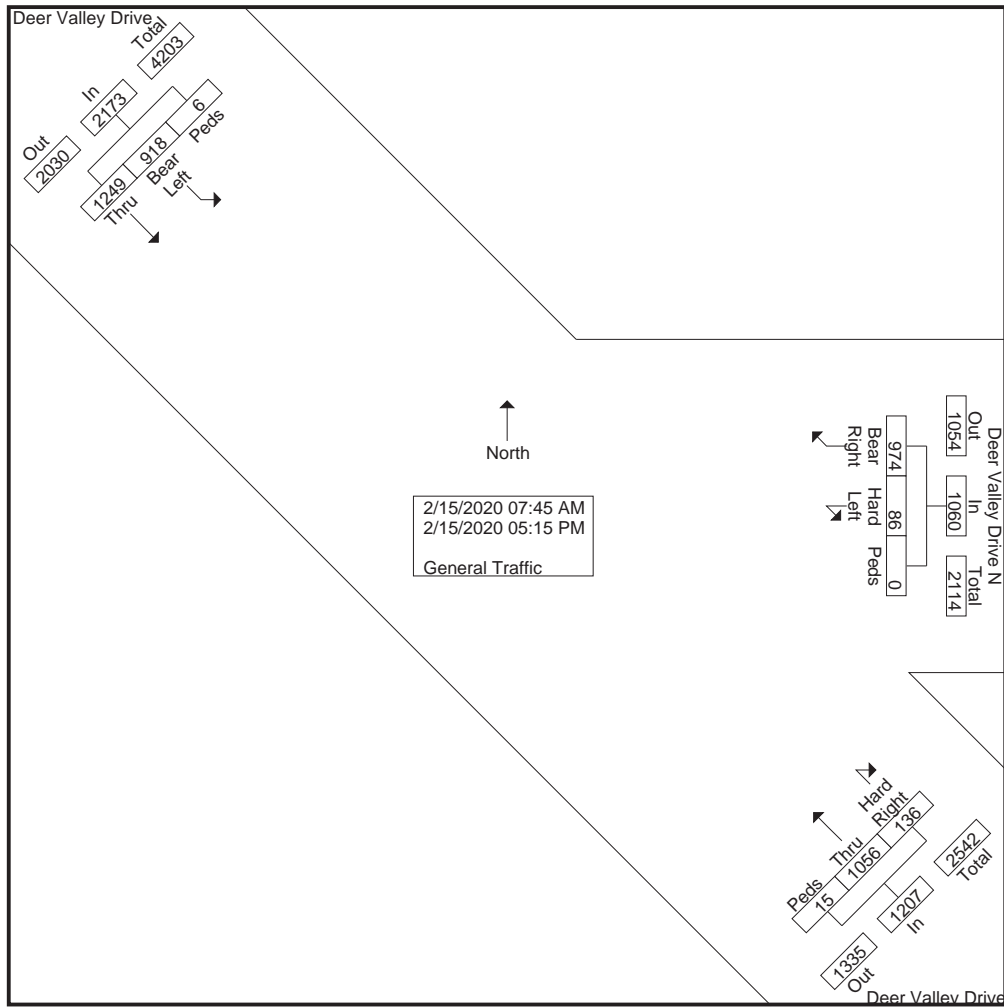

# L2 Data Collection

L2DataCollection.com  
 Idaho (208) 860-7554 Utah (801) 413-2993

Study: FEHR0119  
 Intersection: Deer Valley/ Deer Valley N  
 City, State: Deer Valley, Utah  
 Control: Stop Sign

File Name : Deer Valley Dr & Deer Valley Dr N - D1  
 Site Code : Day 1  
 Start Date : 2/15/2020  
 Page No : 3

Start Time	Deer Valley Drive From Northwest				Deer Valley Drive N From East				Deer Valley Drive From Southeast				Int. Total
	Thru	Bear Left	Peds	App. Total	Bear Right	Hard Left	Peds	App. Total	Hard Right	Thru	Peds	App. Total	
<b>Peak Hour Analysis From 07:45 AM to 11:45 AM - Peak 1 of 1</b>													
Peak Hour for Entire Intersection Begins at 08:00 AM													
08:00 AM	110	101	0	211	34	2	0	36	5	21	1	27	274
08:15 AM	124	70	0	194	29	2	0	31	5	26	0	31	256
08:30 AM	117	55	0	172	53	10	0	63	4	29	0	33	268
08:45 AM	125	46	0	171	48	7	0	55	6	32	4	42	268
Total Volume	476	272	0	748	164	21	0	185	20	108	5	133	1066
% App. Total	63.6	36.4	0		88.6	11.4	0		15	81.2	3.8		
PHF	.952	.673	.000	.886	.774	.525	.000	.734	.833	.844	.313	.792	.973

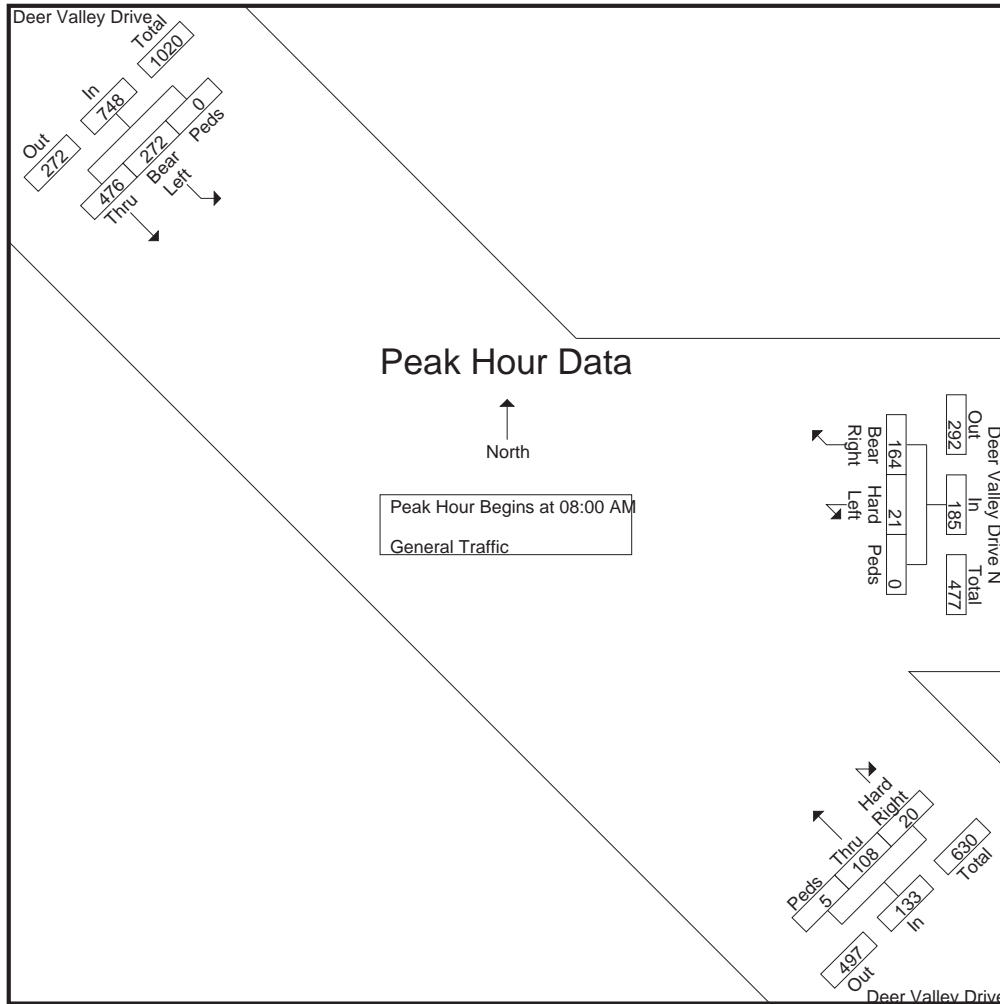



# L2 Data Collection

L2DataCollection.com  
 Idaho (208) 860-7554 Utah (801) 413-2993

Study: FEHR0119  
 Intersection: Deer Valley/ Deer Valley N  
 City, State: Deer Valley, Utah  
 Control: Stop Sign

File Name : Deer Valley Dr & Deer Valley Dr N - D1  
 Site Code : Day 1  
 Start Date : 2/15/2020  
 Page No : 4

Start Time	Deer Valley Drive From Northwest				Deer Valley Drive N From East				Deer Valley Drive From Southeast				Int. Total
	Thru	Bear Left	Peds	App. Total	Bear Right	Hard Left	Peds	App. Total	Hard Right	Thru	Peds	App. Total	

**Peak Hour Analysis From 07:45 AM to 11:45 AM - Peak 1 of 1**

Peak Hour for Each Approach Begins at:

	07:45 AM				08:45 AM				08:45 AM			
+0 mins.	71	123	0	194	48	7	0	55	6	32	4	42
+15 mins.	110	101	0	211	54	7	0	61	2	31	0	33
+30 mins.	124	70	0	194	51	6	0	57	4	31	0	35
+45 mins.	117	55	0	172	55	13	0	68	4	43	0	47
Total Volume	422	349	0	771	208	33	0	241	16	137	4	157
% App. Total	54.7	45.3	0		86.3	13.7	0		10.2	87.3	2.5	
PHF	.851	.709	.000	.914	.945	.635	.000	.886	.667	.797	.250	.835

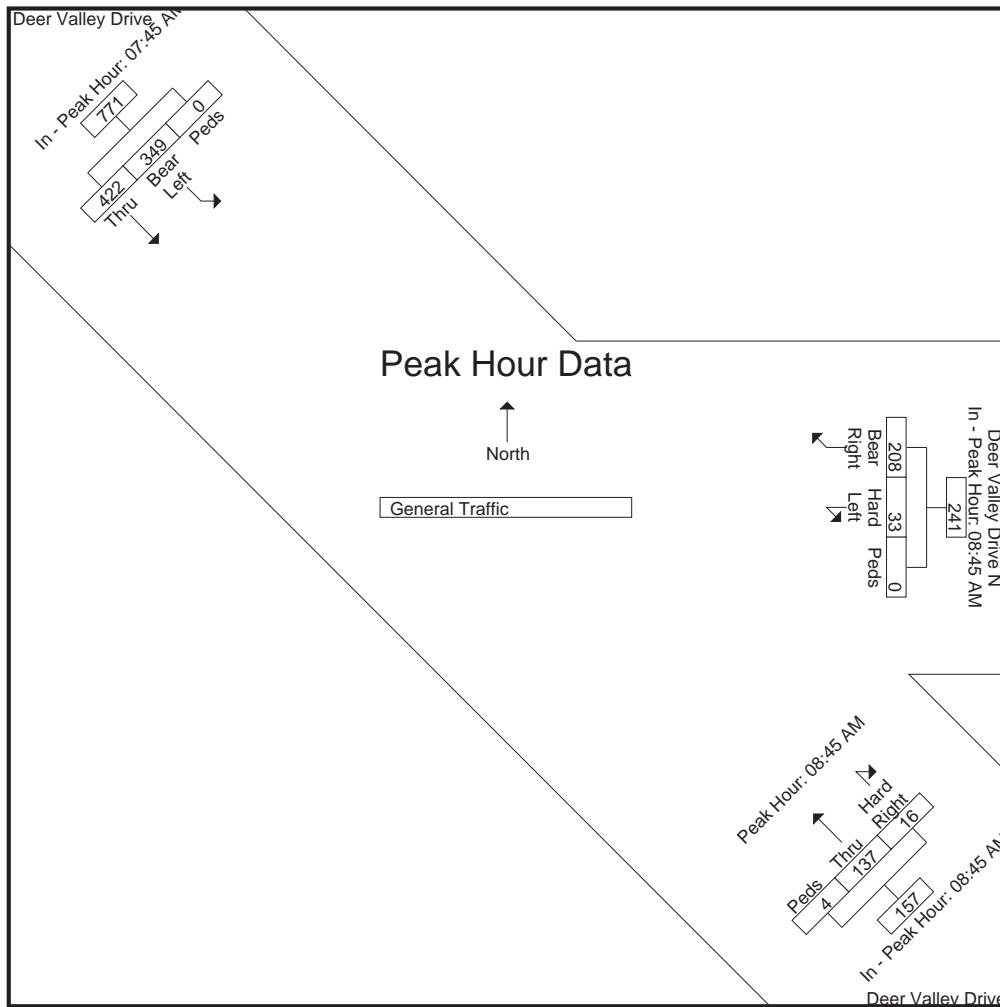

# L2 Data Collection

L2DataCollection.com  
 Idaho (208) 860-7554 Utah (801) 413-2993

Study: FEHR0119  
 Intersection: Deer Valley/ Deer Valley N  
 City, State: Deer Valley, Utah  
 Control: Stop Sign

File Name : Deer Valley Dr & Deer Valley Dr N - D1  
 Site Code : Day 1  
 Start Date : 2/15/2020  
 Page No : 5

Start Time	Deer Valley Drive From Northwest				Deer Valley Drive N From East				Deer Valley Drive From Southeast				Int. Total
	Thru	Bear Left	Peds	App. Total	Bear Right	Hard Left	Peds	App. Total	Hard Right	Thru	Peds	App. Total	
<b>Peak Hour Analysis From 12:00 PM to 05:15 PM - Peak 1 of 1</b>													
Peak Hour for Entire Intersection Begins at 03:45 PM													
03:45 PM	55	50	0	105	81	7	0	88	16	98	3	117	310
04:00 PM	66	41	0	107	83	8	0	91	11	130	0	141	339
04:15 PM	46	49	6	101	73	3	0	76	18	155	0	173	350
04:30 PM	46	68	0	114	104	2	0	106	13	109	1	123	343
Total Volume	213	208	6	427	341	20	0	361	58	492	4	554	1342
% App. Total	49.9	48.7	1.4		94.5	5.5	0		10.5	88.8	0.7		
PHF	.807	.765	.250	.936	.820	.625	.000	.851	.806	.794	.333	.801	.959

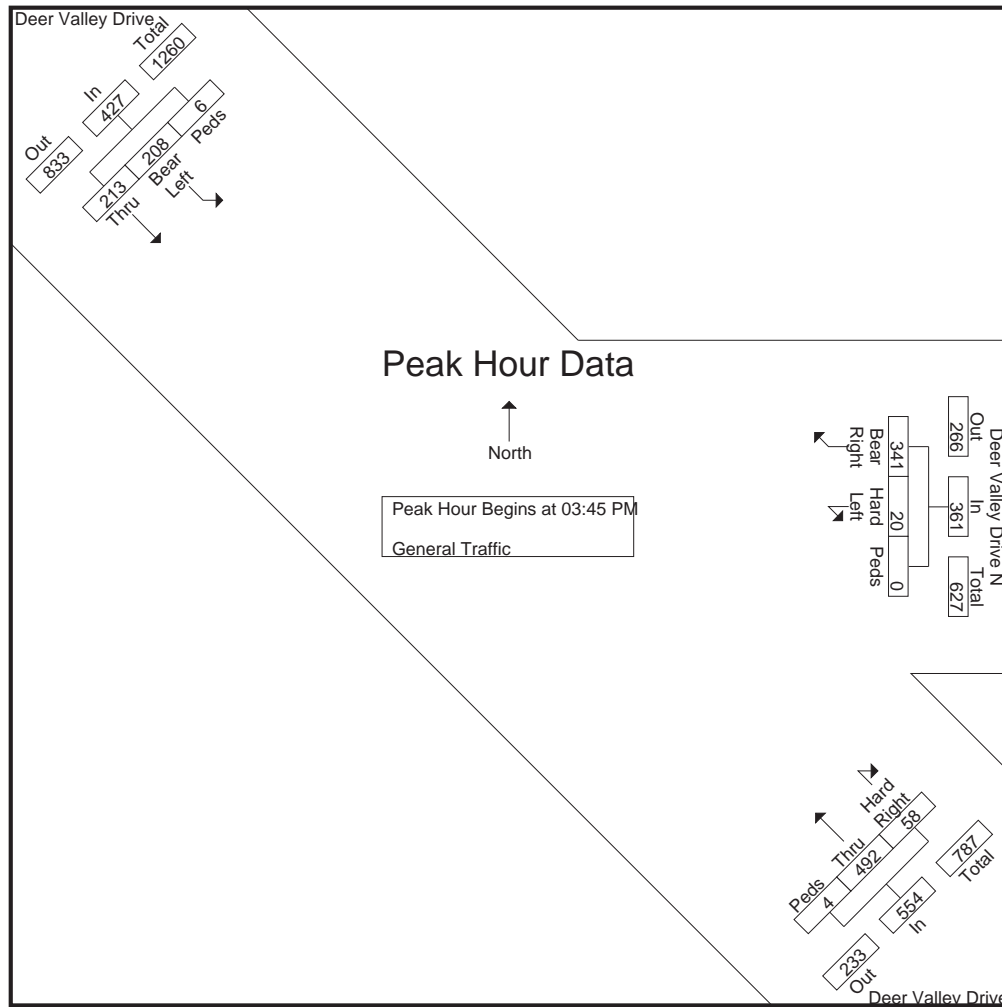

# L2 Data Collection

L2DataCollection.com  
 Idaho (208) 860-7554 Utah (801) 413-2993

Study: FEHR0119  
 Intersection: Deer Valley/ Deer Valley N  
 City, State: Deer Valley, Utah  
 Control: Stop Sign

File Name : Deer Valley Dr & Deer Valley Dr N - D1  
 Site Code : Day 1  
 Start Date : 2/15/2020  
 Page No : 6

Start Time	Deer Valley Drive From Northwest				Deer Valley Drive N From East				Deer Valley Drive From Southeast				Int. Total
	Thru	Bear Left	Peds	App. Total	Bear Right	Hard Left	Peds	App. Total	Hard Right	Thru	Peds	App. Total	

**Peak Hour Analysis From 12:00 PM to 05:15 PM - Peak 1 of 1**

Peak Hour for Each Approach Begins at:

	03:30 PM				03:45 PM				03:45 PM			
+0 mins.	81	47	0	128	81	7	0	88	16	98	3	117
+15 mins.	55	50	0	105	83	8	0	91	11	130	0	141
+30 mins.	66	41	0	107	73	3	0	76	18	155	0	173
+45 mins.	46	49	6	101	104	2	0	106	13	109	1	123
Total Volume	248	187	6	441	341	20	0	361	58	492	4	554
% App. Total	56.2	42.4	1.4		94.5	5.5	0		10.5	88.8	0.7	
PHF	.765	.935	.250	.861	.820	.625	.000	.851	.806	.794	.333	.801

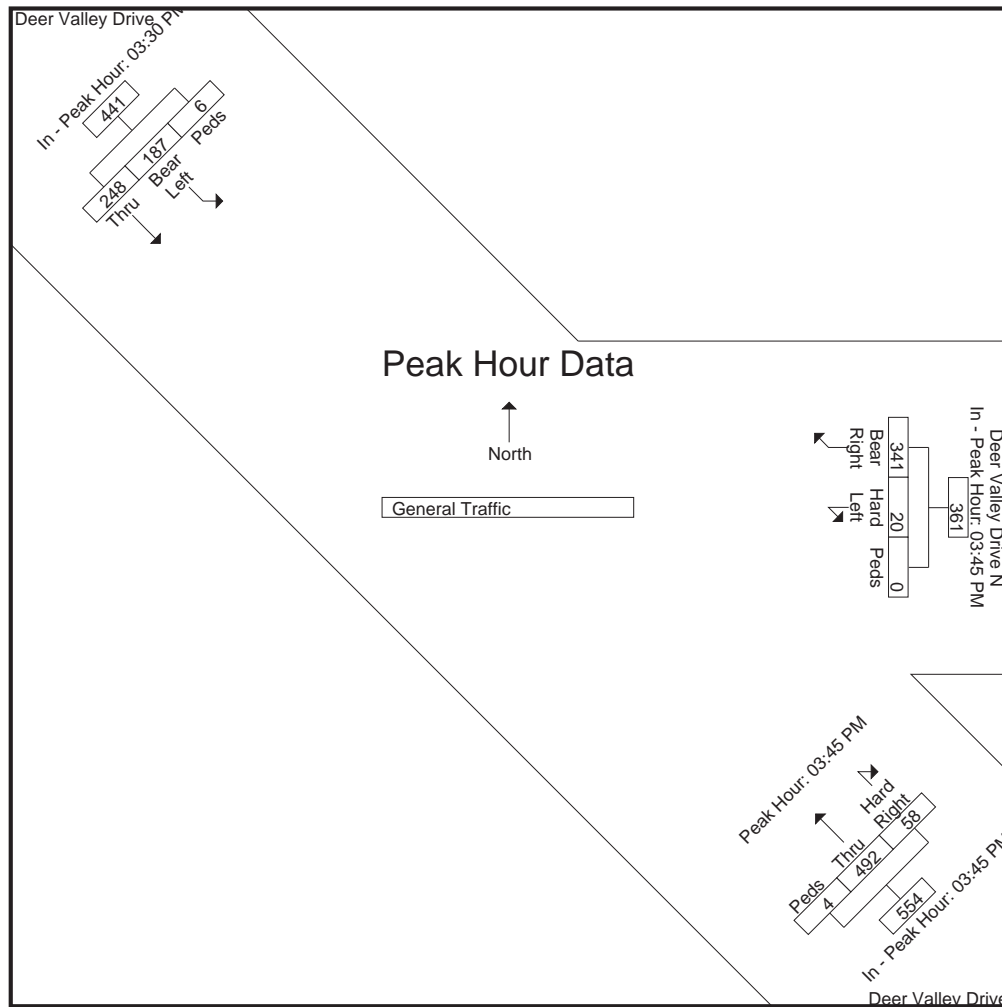

# L2 Data Collection

L2DataCollection.com

Idaho (208) 860-7554 Utah (801) 413-2993

Study: FEHR0119  
Intersection: Deer Valley / Deer Valley N  
City, State: Deer Valley, Utah  
Control: Stop Sign

File Name : Deer Valley Dr & Deer Valley Dr N - D1  
Site Code : Day 1  
Start Date : 2/15/2020  
Page No : 7

Image 1



# L2 Data Collection

L2DataCollection.com

Idaho (208) 860-7554 Utah (801) 413-2993

Study: FEHR0119

Intersection: Deer Valley/ Deer Valley N

City, State: Deer Valley, Utah

Control: Stop Sign

File Name : Deer Valley Dr & Deer Valley Dr N - D2

Site Code : Day 2

Start Date : 2/29/2020

Page No : 1

## Groups Printed- General Traffic

Start Time	Deer Valley Drive From Northwest				Deer Valley Drive N From East				Deer Valley Drive From Southeast				Int. Total
	Thru	Bear Left	Peds	App. Total	Bear Right	Hard Left	Peds	App. Total	Hard Right	Thru	Peds	App. Total	
07:45 AM	53	73	0	126	21	1	0	22	2	21	0	23	171
Total	53	73	0	126	21	1	0	22	2	21	0	23	171
08:00 AM	104	59	0	163	38	0	0	38	2	19	0	21	222
08:15 AM	150	70	0	220	32	1	0	33	3	19	0	22	275
08:30 AM	160	35	0	195	36	5	0	41	5	33	0	38	274
08:45 AM	173	39	0	212	38	1	0	39	2	48	0	50	301
Total	587	203	0	790	144	7	0	151	12	119	0	131	1072
09:00 AM	144	32	0	176	50	0	0	50	5	47	1	53	279
09:15 AM	128	36	0	164	53	4	0	57	2	42	0	44	265
09:30 AM	149	35	0	184	43	5	0	48	2	31	1	34	266
-----													
Total	421	103	0	524	146	9	0	155	9	120	2	131	810
-----													
03:30 PM	66	48	0	114	103	3	1	107	10	111	0	121	342
03:45 PM	51	54	0	105	95	4	0	99	10	116	1	127	331
Total	117	102	0	219	198	7	1	206	20	227	1	248	673
04:00 PM	43	45	0	88	102	8	0	110	12	159	1	172	370
04:15 PM	63	52	0	115	76	8	2	86	9	140	0	149	350
04:30 PM	47	38	0	85	104	2	0	106	13	121	1	135	326
04:45 PM	57	61	0	118	66	2	0	68	6	97	4	107	293
Total	210	196	0	406	348	20	2	370	40	517	6	563	1339
05:00 PM	52	44	0	96	80	4	0	84	11	113	2	126	306
05:15 PM	31	49	0	80	55	1	0	56	7	89	9	105	241
Grand Total	1471	770	0	2241	992	49	3	1044	101	1206	20	1327	4612
Apprch %	65.6	34.4	0		95	4.7	0.3		7.6	90.9	1.5		
Total %	31.9	16.7	0	48.6	21.5	1.1	0.1	22.6	2.2	26.1	0.4	28.8	



# L2 Data Collection

L2DataCollection.com  
 Idaho (208) 860-7554 Utah (801) 413-2993

Study: FEHR0119  
 Intersection: Deer Valley / Deer Valley N  
 City, State: Deer Valley, Utah  
 Control: Stop Sign

File Name : Deer Valley Dr & Deer Valley Dr N - D2  
 Site Code : Day 2  
 Start Date : 2/29/2020  
 Page No : 2

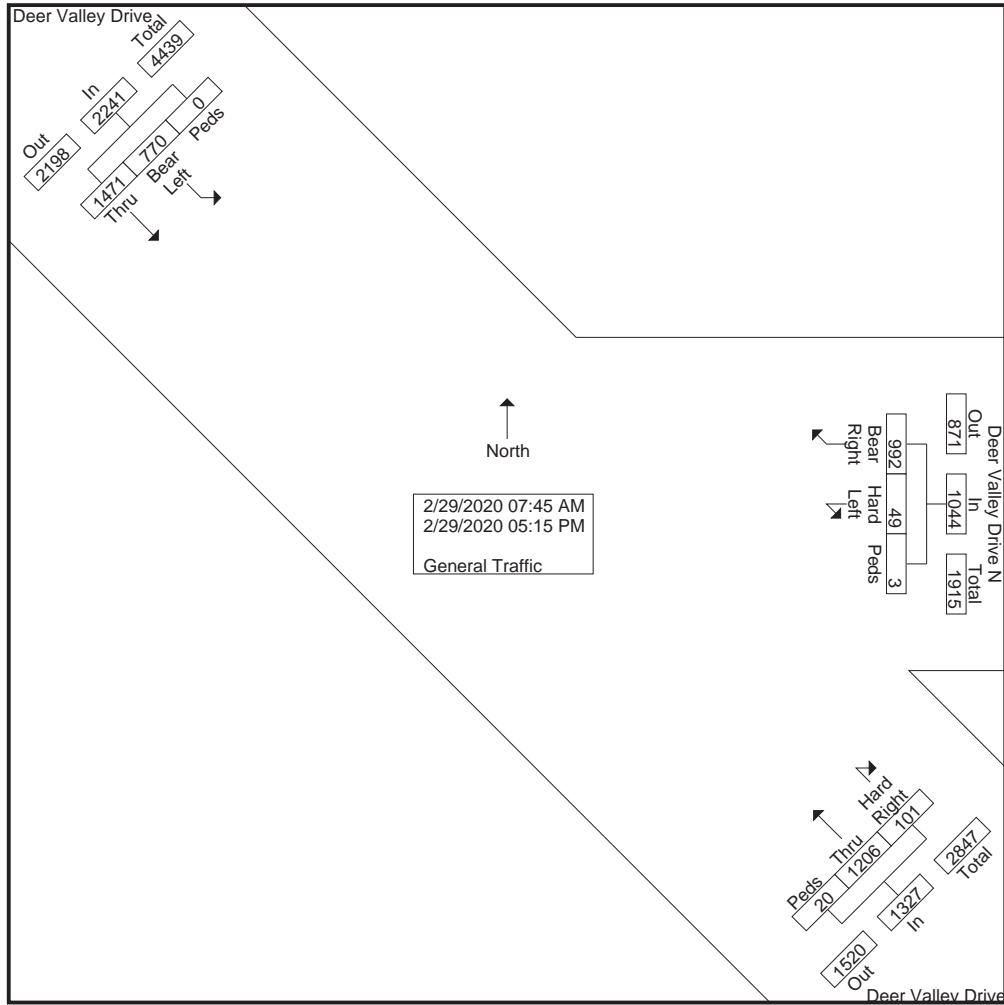

# L2 Data Collection

L2DataCollection.com  
 Idaho (208) 860-7554 Utah (801) 413-2993

Study: FEHR0119  
 Intersection: Deer Valley/ Deer Valley N  
 City, State: Deer Valley, Utah  
 Control: Stop Sign

File Name : Deer Valley Dr & Deer Valley Dr N - D2  
 Site Code : Day 2  
 Start Date : 2/29/2020  
 Page No : 3

Start Time	Deer Valley Drive From Northwest				Deer Valley Drive N From East				Deer Valley Drive From Southeast				Int. Total
	Thru	Bear Left	Peds	App. Total	Bear Right	Hard Left	Peds	App. Total	Hard Right	Thru	Peds	App. Total	
<b>Peak Hour Analysis From 07:45 AM to 11:45 AM - Peak 1 of 1</b>													
Peak Hour for Entire Intersection Begins at 08:15 AM													
08:15 AM	150	70	0	220	32	1	0	33	3	19	0	22	275
08:30 AM	160	35	0	195	36	5	0	41	5	33	0	38	274
08:45 AM	173	39	0	212	38	1	0	39	2	48	0	50	301
09:00 AM	144	32	0	176	50	0	0	50	5	47	1	53	279
Total Volume	627	176	0	803	156	7	0	163	15	147	1	163	1129
% App. Total	78.1	21.9	0		95.7	4.3	0		9.2	90.2	0.6		
PHF	.906	.629	.000	.913	.780	.350	.000	.815	.750	.766	.250	.769	.938

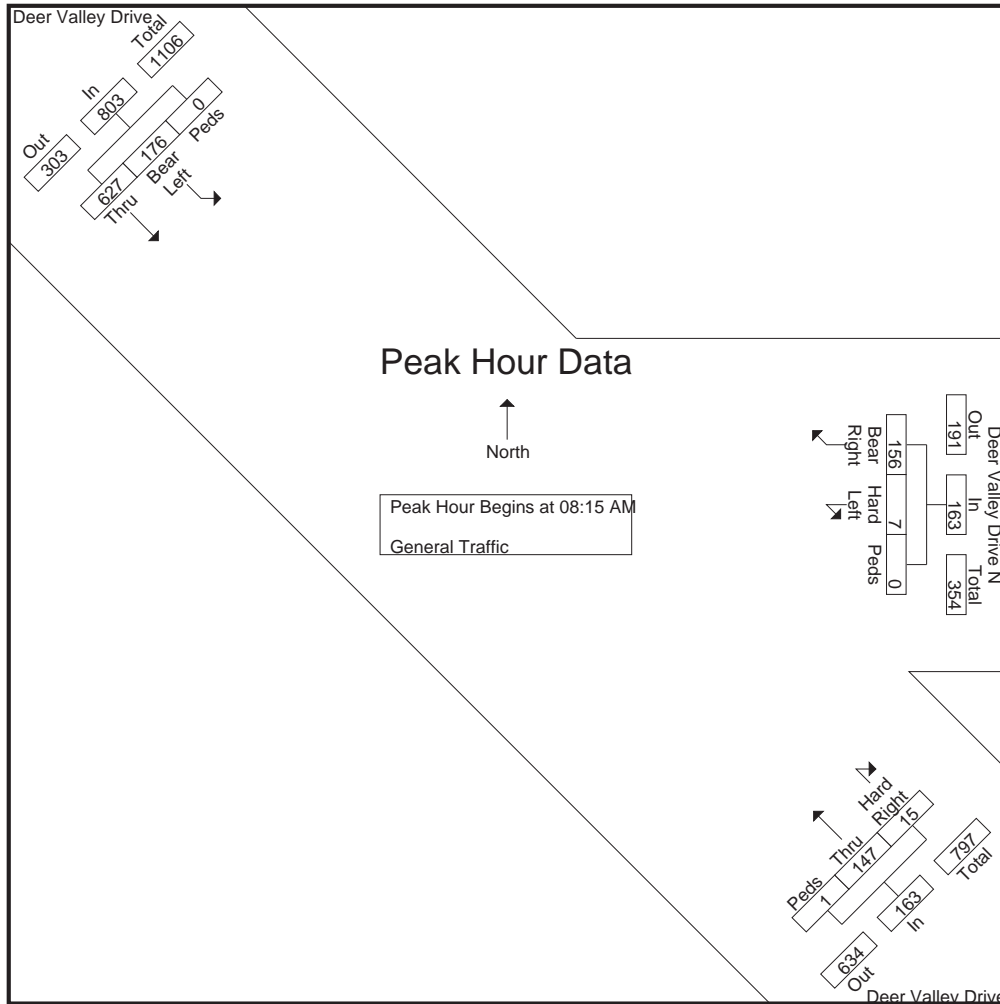

# L2 Data Collection

L2DataCollection.com  
 Idaho (208) 860-7554 Utah (801) 413-2993

Study: FEHR0119  
 Intersection: Deer Valley/ Deer Valley N  
 City, State: Deer Valley, Utah  
 Control: Stop Sign

File Name : Deer Valley Dr & Deer Valley Dr N - D2  
 Site Code : Day 2  
 Start Date : 2/29/2020  
 Page No : 4

Start Time	Deer Valley Drive From Northwest				Deer Valley Drive N From East				Deer Valley Drive From Southeast				Int. Total
	Thru	Bear Left	Peds	App. Total	Bear Right	Hard Left	Peds	App. Total	Hard Right	Thru	Peds	App. Total	

**Peak Hour Analysis From 07:45 AM to 11:45 AM - Peak 1 of 1**

Peak Hour for Each Approach Begins at:

	08:15 AM				08:45 AM				08:30 AM			
+0 mins.	150	70	0	220	38	1	0	39	5	33	0	38
+15 mins.	160	35	0	195	50	0	0	50	2	48	0	50
+30 mins.	173	39	0	212	53	4	0	57	5	47	1	53
+45 mins.	144	32	0	176	43	5	0	48	2	42	0	44
Total Volume	627	176	0	803	184	10	0	194	14	170	1	185
% App. Total	78.1	21.9	0		94.8	5.2	0		7.6	91.9	0.5	
PHF	.906	.629	.000	.913	.868	.500	.000	.851	.700	.885	.250	.873

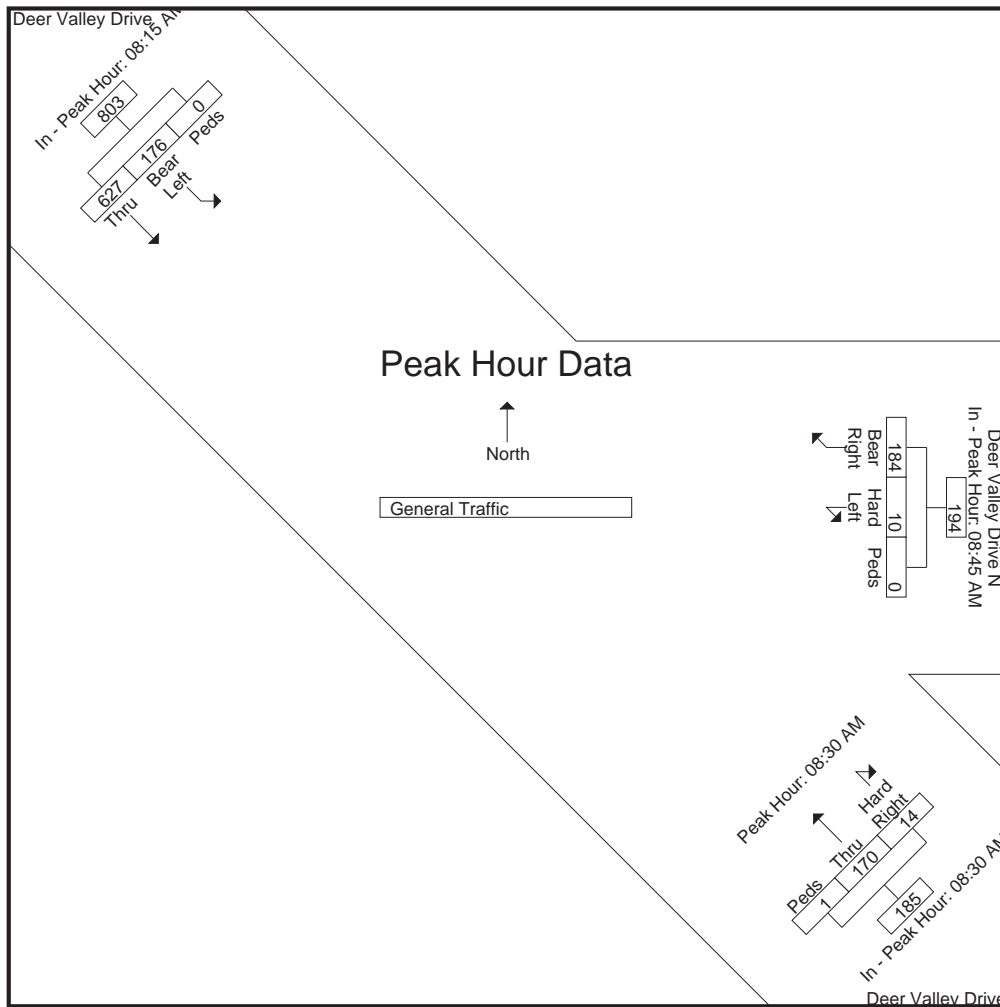

# L2 Data Collection

L2DataCollection.com  
 Idaho (208) 860-7554 Utah (801) 413-2993

Study: FEHR0119  
 Intersection: Deer Valley/ Deer Valley N  
 City, State: Deer Valley, Utah  
 Control: Stop Sign

File Name : Deer Valley Dr & Deer Valley Dr N - D2  
 Site Code : Day 2  
 Start Date : 2/29/2020  
 Page No : 5

Start Time	Deer Valley Drive From Northwest				Deer Valley Drive N From East				Deer Valley Drive From Southeast				Int. Total
	Thru	Bear Left	Peds	App. Total	Bear Right	Hard Left	Peds	App. Total	Hard Right	Thru	Peds	App. Total	
<b>Peak Hour Analysis From 12:00 PM to 05:15 PM - Peak 1 of 1</b>													
Peak Hour for Entire Intersection Begins at 03:30 PM													
03:30 PM	66	48	0	114	103	3	1	107	10	111	0	121	342
03:45 PM	51	54	0	105	95	4	0	99	10	116	1	127	331
04:00 PM	43	45	0	88	102	8	0	110	12	159	1	172	370
04:15 PM	63	52	0	115	76	8	2	86	9	140	0	149	350
Total Volume	223	199	0	422	376	23	3	402	41	526	2	569	1393
% App. Total	52.8	47.2	0		93.5	5.7	0.7		7.2	92.4	0.4		
PHF	.845	.921	.000	.917	.913	.719	.375	.914	.854	.827	.500	.827	.941

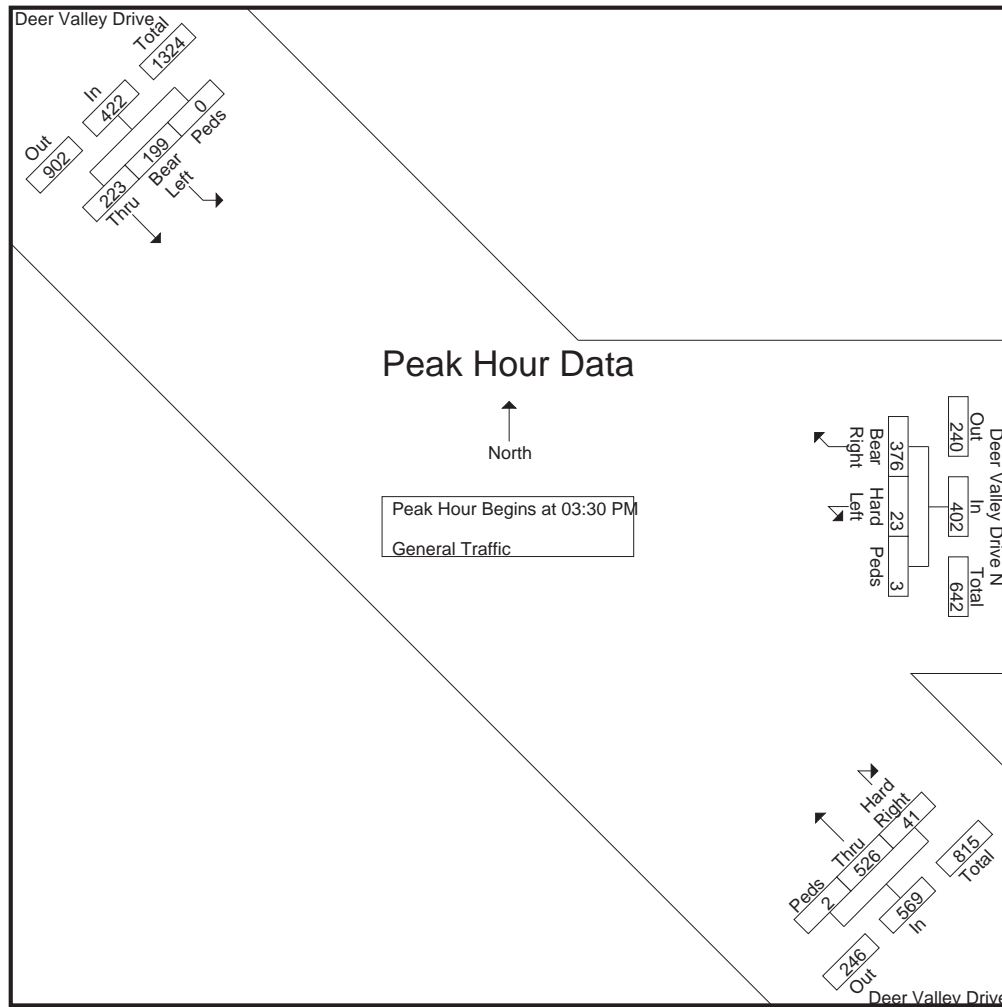

# L2 Data Collection

L2DataCollection.com  
 Idaho (208) 860-7554 Utah (801) 413-2993

Study: FEHR0119  
 Intersection: Deer Valley/ Deer Valley N  
 City, State: Deer Valley, Utah  
 Control: Stop Sign

File Name : Deer Valley Dr & Deer Valley Dr N - D2  
 Site Code : Day 2  
 Start Date : 2/29/2020  
 Page No : 6

Start Time	Deer Valley Drive From Northwest				Deer Valley Drive N From East				Deer Valley Drive From Southeast				Int. Total
	Thru	Bear Left	Peds	App. Total	Bear Right	Hard Left	Peds	App. Total	Hard Right	Thru	Peds	App. Total	

**Peak Hour Analysis From 12:00 PM to 05:15 PM - Peak 1 of 1**

Peak Hour for Each Approach Begins at:

	03:30 PM				03:30 PM				03:45 PM			
+0 mins.	66	48	0	114	103	3	1	107	10	116	1	127
+15 mins.	51	54	0	105	95	4	0	99	12	159	1	172
+30 mins.	43	45	0	88	102	8	0	110	9	140	0	149
+45 mins.	63	52	0	115	76	8	2	86	13	121	1	135
Total Volume	223	199	0	422	376	23	3	402	44	536	3	583
% App. Total	52.8	47.2	0		93.5	5.7	0.7		7.5	91.9	0.5	
PHF	.845	.921	.000	.917	.913	.719	.375	.914	.846	.843	.750	.847

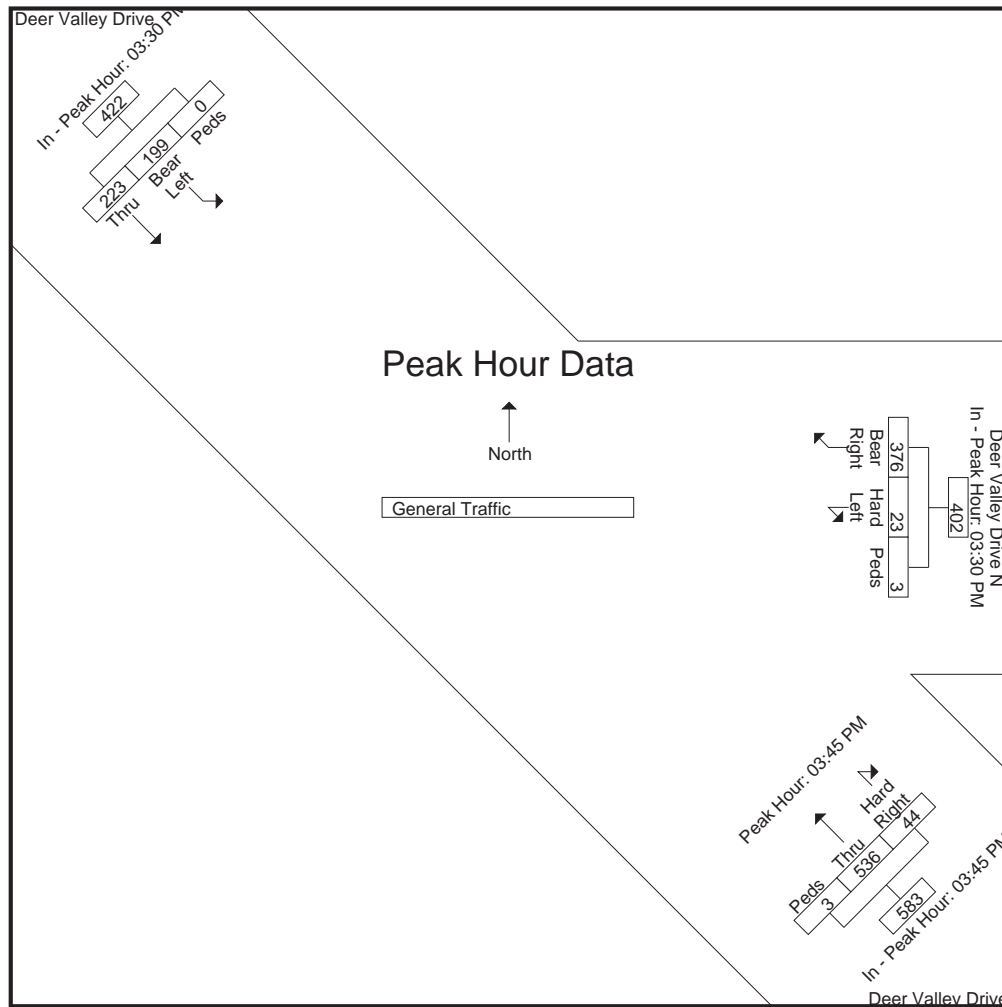



# L2 Data Collection

L2DataCollection.com

Idaho (208) 860-7554 Utah (801) 413-2993

Study: FEHR0119  
Intersection: Deer Valley / Deer Valley N  
City, State: Deer Valley, Utah  
Control: Stop Sign

File Name : Deer Valley Dr & Deer Valley Dr N - D2  
Site Code : Day 2  
Start Date : 2/29/2020  
Page No : 7

Image 1



# L2 Data Collection

L2DataCollection.com  
Idaho (208) 860-7554 Utah (801) 413-2993

Study: FEHR0124  
Intersection: Deer Valley Dr / Marsac Av  
City, State: Park City, Utah  
Control: Yields

File Name : Deer Valley Dr & Marsac Ave RDBT  
Site Code : Saturday  
Start Date : 12/19/2020  
Page No : 1

## Groups Printed- General Traffic - Turns

Start Time	Deer Valley Drive From North					Deer Valley Drive From East					Marsac Avenue From South					To Swede Alley (Buses Only) From West					Int. Total
	Right	Thru	Left	Peds	App. Total	Right	Thru	Left	Peds	App. Total	Right	Thru	Left	Peds	App. Total	Right	Thru	Left	Peds	App. Total	
07:45 AM	1	105	141	0	247	37	2	5	0	44	3	19	0	1	23	1	3	1	0	5	319
Total	1	105	141	0	247	37	2	5	0	44	3	19	0	1	23	1	3	1	0	5	319
08:00 AM	2	59	173	0	234	30	2	1	0	33	12	23	0	1	36	1	3	0	1	5	308
08:15 AM	3	78	171	0	252	46	3	4	0	53	12	22	0	1	35	0	3	0	2	5	345
08:30 AM	1	79	171	0	251	39	4	11	0	54	13	22	0	2	37	3	7	0	1	11	353
08:45 AM	2	74	178	0	254	55	4	6	2	67	16	26	1	3	46	3	6	1	4	14	381
Total	8	290	693	0	991	170	13	22	2	207	53	93	1	7	154	7	19	1	8	35	1387
09:00 AM	3	70	140	0	213	74	4	4	2	84	8	31	0	8	47	4	3	1	6	14	358
09:15 AM	1	74	114	3	192	63	2	6	2	73	9	31	0	1	41	0	4	0	1	5	311
09:30 AM	1	66	116	0	183	75	0	2	2	79	7	35	0	0	42	0	3	1	1	5	309
Total	5	210	370	3	588	212	6	12	6	236	24	97	0	9	130	4	10	2	8	24	978
03:30 PM	5	97	155	0	257	155	2	7	0	164	18	97	0	5	120	4	0	3	0	7	548
03:45 PM	2	90	162	0	254	157	4	9	0	170	17	116	0	7	140	2	4	1	4	11	575
Total	7	187	317	0	511	312	6	16	0	334	35	213	0	12	260	6	4	4	4	18	1123
04:00 PM	1	101	141	0	243	177	1	12	0	190	9	106	1	7	123	1	2	0	3	6	562
04:15 PM	1	93	129	5	228	180	3	9	1	193	16	106	1	2	125	0	3	0	2	5	551
04:30 PM	2	91	144	0	237	176	4	5	0	185	16	100	0	7	123	2	2	4	1	9	554
04:45 PM	3	83	145	0	231	139	3	10	0	152	16	135	1	3	155	0	4	1	0	5	543
Total	7	368	559	5	939	672	11	36	1	720	57	447	3	19	526	3	11	5	6	25	2210
05:00 PM	1	74	135	0	210	129	3	5	1	138	11	104	0	3	118	1	2	1	2	6	472
05:15 PM	3	95	134	0	232	168	0	4	2	174	15	132	1	3	151	1	2	1	4	8	565
Grand Total	32	1329	2349	8	3718	1700	41	100	12	1853	198	1105	5	54	1362	23	51	15	32	121	7054
Apprch %	0.9	35.7	63.2	0.2		91.7	2.2	5.4	0.6		14.5	81.1	0.4	4		19	42.1	12.4	26.4		
Total %	0.5	18.8	33.3	0.1	52.7	24.1	0.6	1.4	0.2	26.3	2.8	15.7	0.1	0.8	19.3	0.3	0.7	0.2	0.5	1.7	
General Traffic	32	1329	1826	8	3195	1700	41	96	12	1849	198	1105	1	54	1358	23	51	14	32	120	6522
% General Traffic	100	100	77.7	100	85.9	100	100	96	100	99.8	100	100	20	100	99.7	100	100	93.3	100	99.2	92.5
U-Turns	0	0	523	0	523	0	0	4	0	4	0	0	4	0	4	0	0	1	0	1	532
% U-Turns	0	0	22.3	0	14.1	0	0	4	0	0.2	0	0	80	0	0.3	0	0	6.7	0	0.8	7.5

# L2 Data Collection

L2DataCollection.com  
 Idaho (208) 860-7554 Utah (801) 413-2993

Study: FEHR0124  
 Intersection: Deer Valley Dr / Marsac Av  
 City, State: Park City, Utah  
 Control: Yields

File Name : Deer Valley Dr & Marsac Ave RDBT  
 Site Code : Saturday  
 Start Date : 12/19/2020  
 Page No : 2

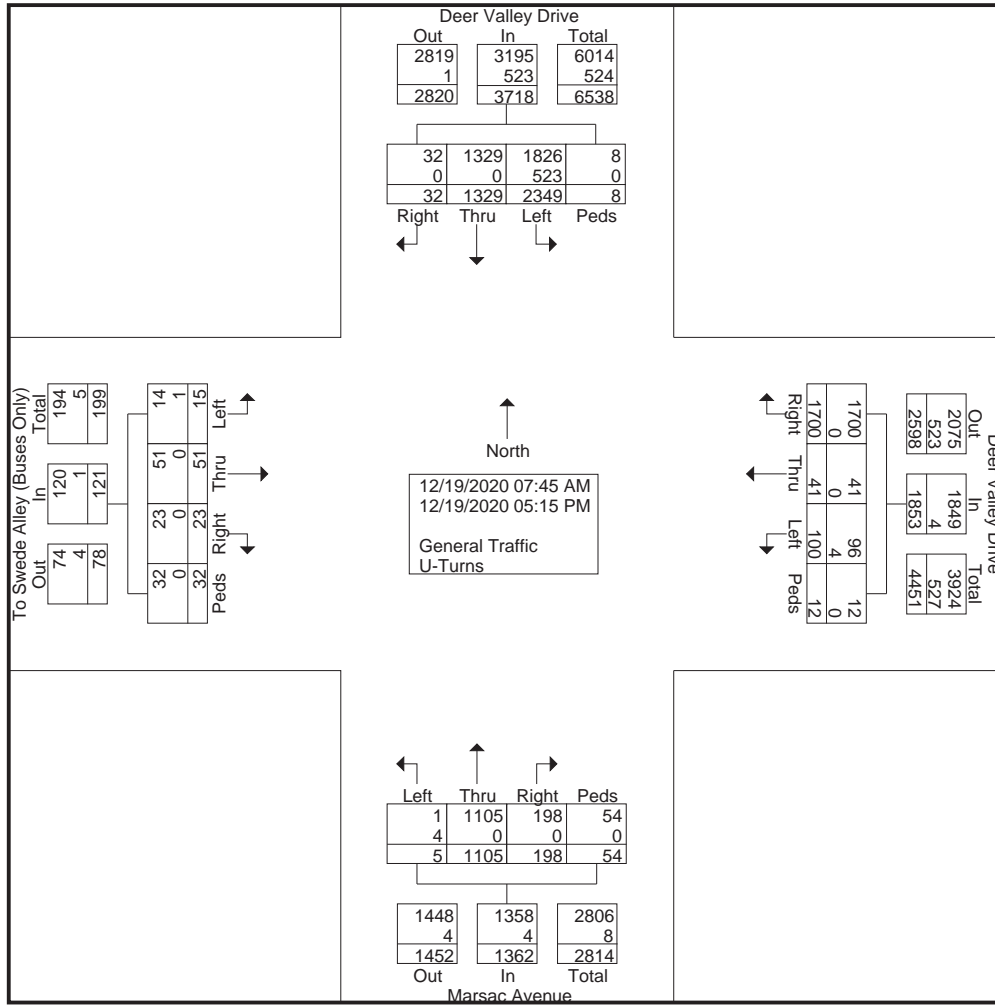

# L2 Data Collection

L2DataCollection.com  
 Idaho (208) 860-7554 Utah (801) 413-2993

Study: FEHR0124  
 Intersection: Deer Valley Dr / Marsac Av  
 City, State: Park City, Utah  
 Control: Yields

File Name : Deer Valley Dr & Marsac Ave RDBT  
 Site Code : Saturday  
 Start Date : 12/19/2020  
 Page No : 3

Start Time	Deer Valley Drive From North					Deer Valley Drive From East					Marsac Avenue From South					To Swede Alley (Buses Only) From West					Int. Total
	Right	Thru	Left	Peds	App. Total	Right	Thru	Left	Peds	App. Total	Right	Thru	Left	Peds	App. Total	Right	Thru	Left	Peds	App. Total	

**Peak Hour Analysis From 07:45 AM to 11:45 AM - Peak 1 of 1**

Peak Hour for Entire Intersection Begins at 08:15 AM

08:15 AM	3	78	171	0	252	46	3	4	0	53	12	22	0	1	35	0	3	0	2	5	345
08:30 AM	1	79	171	0	251	39	4	11	0	54	13	22	0	2	37	3	7	0	1	11	353
08:45 AM	2	74	178	0	254	55	4	6	2	67	16	26	1	3	46	3	6	1	4	14	381
09:00 AM	3	70	140	0	213	74	4	4	2	84	8	31	0	8	47	4	3	1	6	14	358
Total Volume	9	301	660	0	970	214	15	25	4	258	49	101	1	14	165	10	19	2	13	44	1437
% App. Total	0.9	31	68	0		82.9	5.8	9.7	1.6		29.7	61.2	0.6	8.5		22.7	43.2	4.5	29.5		
PHF	.750	.953	.927	.000	.955	.723	.938	.568	.500	.768	.766	.815	.250	.438	.878	.625	.679	.500	.542	.786	.943
General Traffic	9	301	641	0	951	214	15	25	4	258	49	101	1	14	165	10	19	2	13	44	1418
% General Traffic	100	100	97.1	0	98.0	100	100	100	100	100	100	100	100	100	100	100	100	100	100	100	98.7
U-Turns	0	0	19	0	19	0	0	0	0	0	0	0	0	0	0	0	0	0	0	0	19
% U-Turns	0	0	2.9	0	2.0	0	0	0	0	0	0	0	0	0	0	0	0	0	0	0	1.3

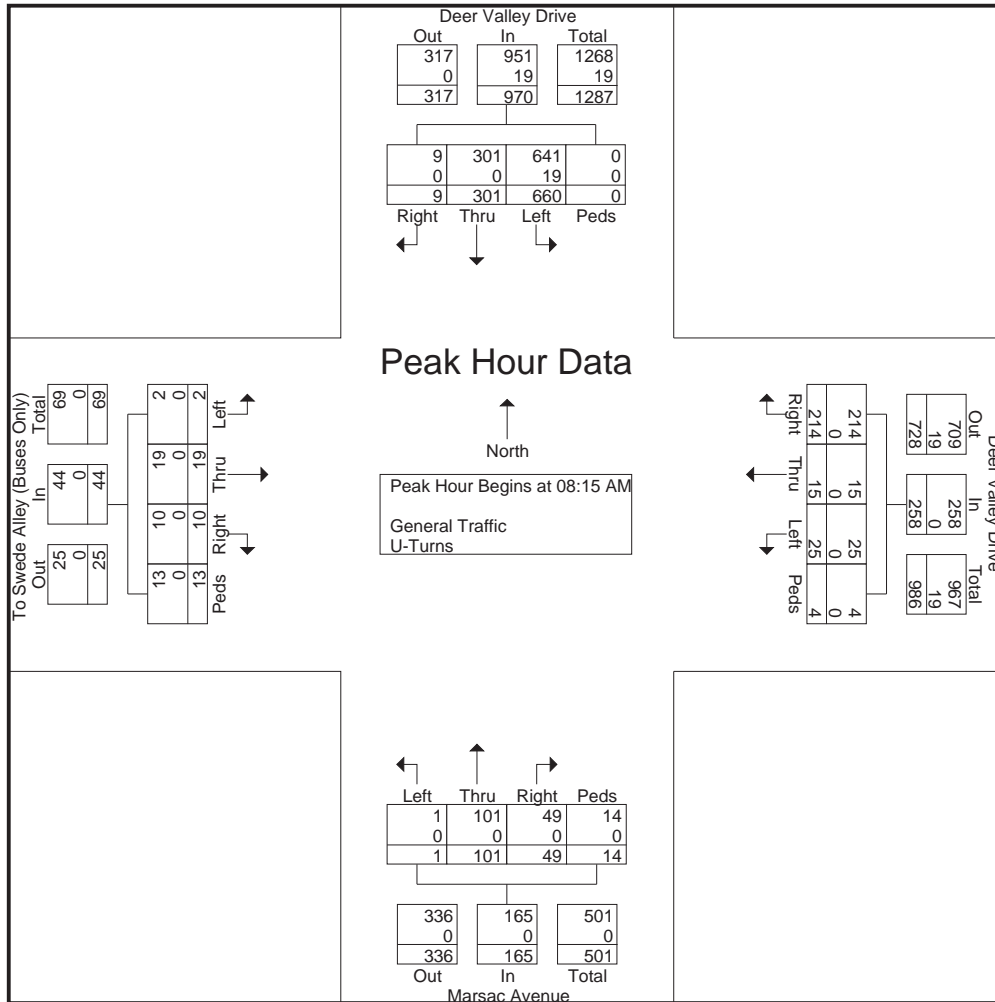

# L2 Data Collection

L2DataCollection.com  
Idaho (208) 860-7554 Utah (801) 413-2993

Study: FEHR0124  
Intersection: Deer Valley Dr / Marsac Av  
City, State: Park City, Utah  
Control: Yields

File Name : Deer Valley Dr & Marsac Ave RDBT  
Site Code : Saturday  
Start Date : 12/19/2020  
Page No : 4

Start Time	Deer Valley Drive From North					Deer Valley Drive From East					Marsac Avenue From South					To Swede Alley (Buses Only) From West					Int. Total
	Right	Thru	Left	Peds	App. Total	Right	Thru	Left	Peds	App. Total	Right	Thru	Left	Peds	App. Total	Right	Thru	Left	Peds	App. Total	

**Peak Hour Analysis From 07:45 AM to 11:45 AM - Peak 1 of 1**

Peak Hour for Each Approach Begins at:

	08:00 AM					08:45 AM					08:45 AM					08:15 AM				
+0 mins.	2	59	173	0	234	55	4	6	2	67	16	26	1	3	46	0	3	0	2	5
+15 mins.	3	78	171	0	252	74	4	4	2	84	8	31	0	8	47	3	7	0	1	11
+30 mins.	1	79	171	0	251	63	2	6	2	73	9	31	0	1	41	3	6	1	4	14
+45 mins.	2	74	178	0	254	75	0	2	2	79	7	35	0	0	42	4	3	1	6	14
Total Volume	8	290	693	0	991	267	10	18	8	303	40	123	1	12	176	10	19	2	13	44
% App. Total	0.8	29.3	69.9	0		88.1	3.3	5.9	2.6		22.7	69.9	0.6	6.8		22.7	43.2	4.5	29.5	
PHF	.667	.918	.973	.000	.975	.890	.625	.750	1.000	.902	.625	.879	.250	.375	.936	.625	.679	.500	.542	.786
General Traffic	8	290	673	0	971	267	10	18	8	303	40	123	1	12	176	10	19	2	13	44
% General Traffic	100	100	97.1	0	98	100	100	100	100	100	100	100	100	100	100	100	100	100	100	100
U-Turns	0	0	20	0	20	0	0	0	0	0	0	0	0	0	0	0	0	0	0	0
% U-Turns	0	0	2.9	0	2	0	0	0	0	0	0	0	0	0	0	0	0	0	0	0

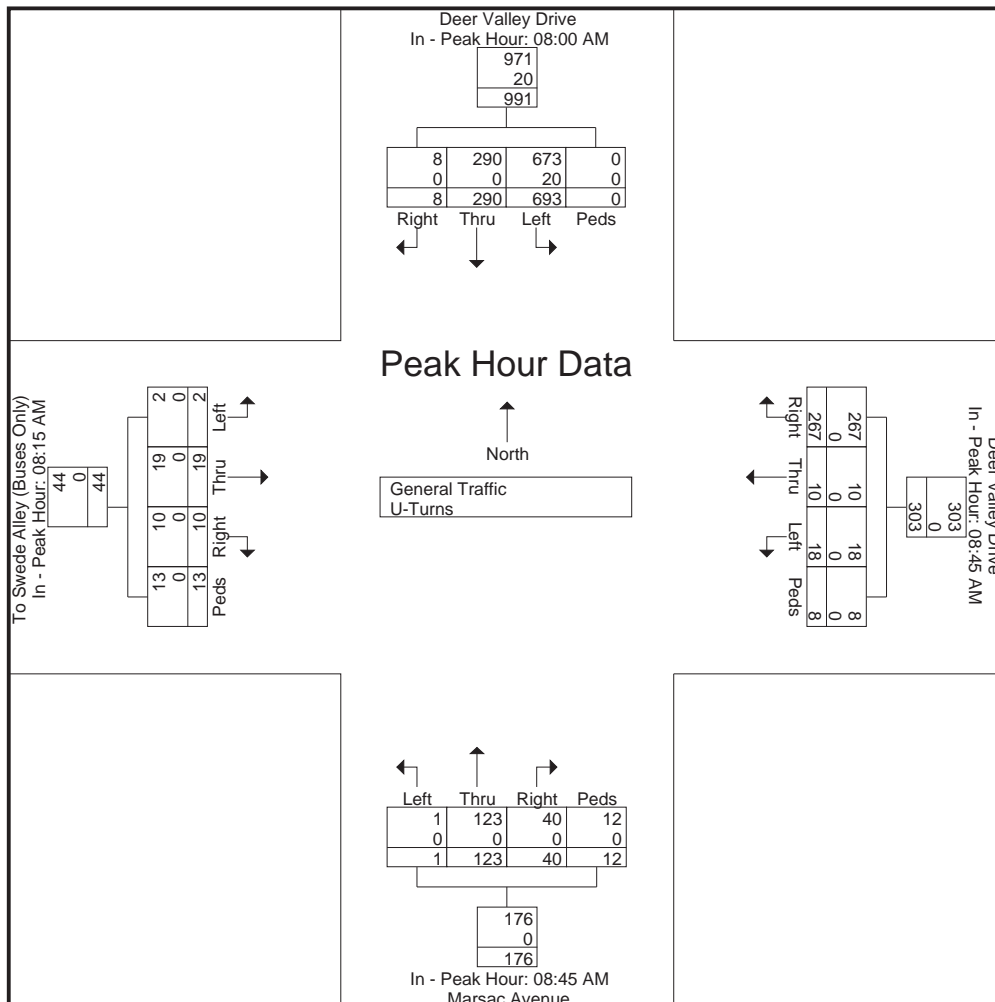



# L2 Data Collection

L2DataCollection.com  
 Idaho (208) 860-7554 Utah (801) 413-2993

Study: FEHR0124  
 Intersection: Deer Valley Dr / Marsac Av  
 City, State: Park City, Utah  
 Control: Yields

File Name : Deer Valley Dr & Marsac Ave RDBT  
 Site Code : Saturday  
 Start Date : 12/19/2020  
 Page No : 5

Start Time	Deer Valley Drive From North					Deer Valley Drive From East					Marsac Avenue From South					To Swede Alley (Buses Only) From West					Int. Total
	Right	Thru	Left	Peds	App. Total	Right	Thru	Left	Peds	App. Total	Right	Thru	Left	Peds	App. Total	Right	Thru	Left	Peds	App. Total	

**Peak Hour Analysis From 12:00 PM to 05:15 PM - Peak 1 of 1**

Peak Hour for Entire Intersection Begins at 03:45 PM

03:45 PM	2	90	162	0	254	157	4	9	0	170	17	116	0	7	140	2	4	1	4	11	575
04:00 PM	1	101	141	0	243	177	1	12	0	190	9	106	1	7	123	1	2	0	3	6	562
04:15 PM	1	93	129	5	228	180	3	9	1	193	16	106	1	2	125	0	3	0	2	5	551
04:30 PM	2	91	144	0	237	176	4	5	0	185	16	100	0	7	123	2	2	4	1	9	554
Total Volume	6	375	576	5	962	690	12	35	1	738	58	428	2	23	511	5	11	5	10	31	2242
% App. Total	0.6	39	59.9	0.5		93.5	1.6	4.7	0.1		11.4	83.8	0.4	4.5		16.1	35.5	16.1	32.3		
PHF	.750	.928	.889	.250	.947	.958	.750	.729	.250	.956	.853	.922	.500	.821	.913	.625	.688	.313	.625	.705	.975
General Traffic	6	375	347	5	733	690	12	34	1	737	58	428	0	23	509	5	11	5	10	31	2010
% General Traffic	100	100	60.2	100	76.2	100	100	97.1	100	99.9	100	100	0	100	99.6	100	100	100	100	100	89.7
U-Turns	0	0	229	0	229	0	0	1	0	1	0	0	2	0	2	0	0	0	0	0	232
% U-Turns	0	0	39.8	0	23.8	0	0	2.9	0	0.1	0	0	100	0	0.4	0	0	0	0	0	10.3

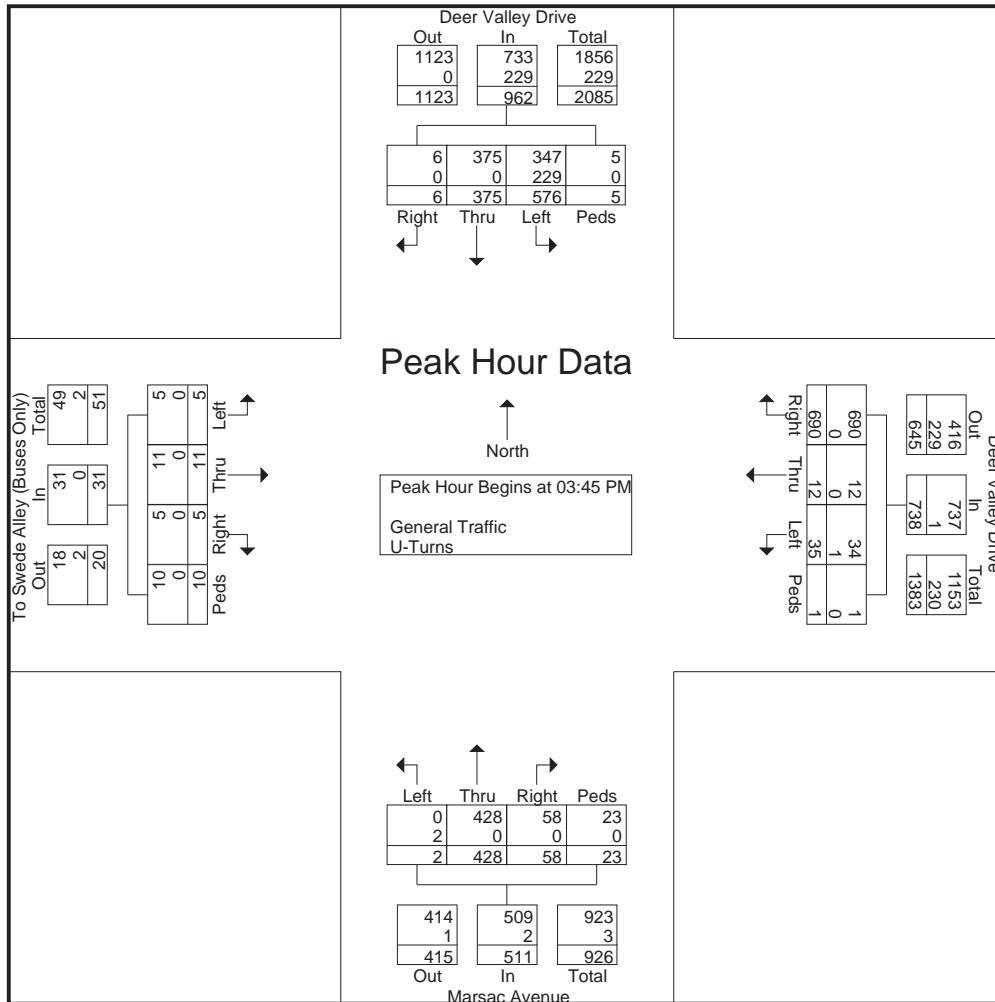

# L2 Data Collection

L2DataCollection.com  
Idaho (208) 860-7554 Utah (801) 413-2993

Study: FEHR0124  
Intersection: Deer Valley Dr / Marsac Av  
City, State: Park City, Utah  
Control: Yields

File Name : Deer Valley Dr & Marsac Ave RDBT  
Site Code : Saturday  
Start Date : 12/19/2020  
Page No : 6

Start Time	Deer Valley Drive From North					Deer Valley Drive From East					Marsac Avenue From South					To Swede Alley (Buses Only) From West					Int. Total
	Right	Thru	Left	Peds	App. Total	Right	Thru	Left	Peds	App. Total	Right	Thru	Left	Peds	App. Total	Right	Thru	Left	Peds	App. Total	

**Peak Hour Analysis From 12:00 PM to 05:15 PM - Peak 1 of 1**

Peak Hour for Each Approach Begins at:

	03:30 PM					03:45 PM					04:30 PM					03:45 PM				
+0 mins.	5	97	155	0	257	157	4	9	0	170	16	100	0	7	123	2	4	1	4	11
+15 mins.	2	90	162	0	254	177	1	12	0	190	16	135	1	3	155	1	2	0	3	6
+30 mins.	1	101	141	0	243	180	3	9	1	193	11	104	0	3	118	0	3	0	2	5
+45 mins.	1	93	129	5	228	176	4	5	0	185	15	132	1	3	151	2	2	4	1	9
Total Volume	9	381	587	5	982	690	12	35	1	738	58	471	2	16	547	5	11	5	10	31
% App. Total	0.9	38.8	59.8	0.5		93.5	1.6	4.7	0.1		10.6	86.1	0.4	2.9		16.1	35.5	16.1	32.3	
PHF	.450	.943	.906	.250	.955	.958	.750	.729	.250	.956	.906	.872	.500	.571	.882	.625	.688	.313	.625	.705
General Traffic	9	381	367	5	762	690	12	34	1	737	58	471	0	16	545	5	11	5	10	31
% General Traffic	100	100	62.5	100	77.6	100	100	97.1	100	99.9	100	100	0	100	99.6	100	100	100	100	100
U-Turns	0	0	220	0	220	0	0	1	0	1	0	0	2	0	2	0	0	0	0	0
% U-Turns	0	0	37.5	0	22.4	0	0	2.9	0	0.1	0	0	100	0	0.4	0	0	0	0	0

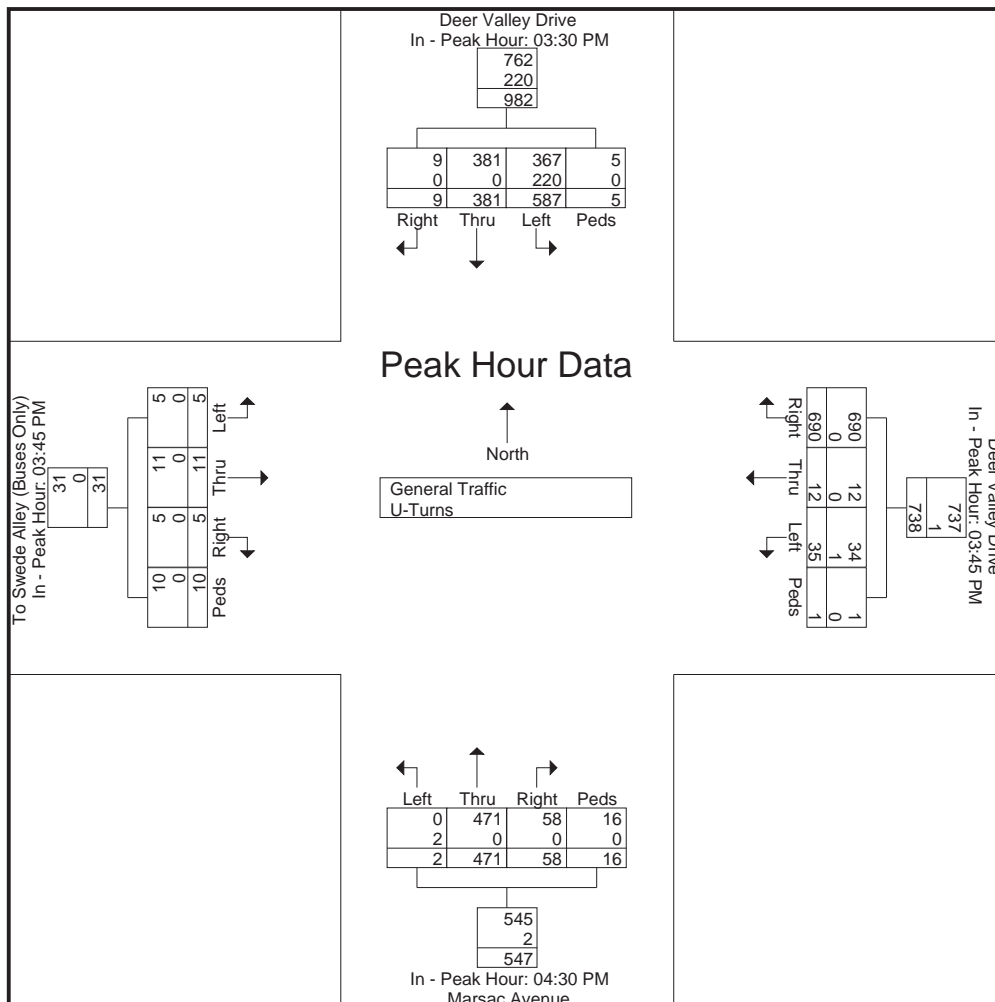

# L2 Data Collection

L2DataCollection.com

Idaho (208) 860-7554 Utah (801) 413-2993

Study: FEHR0124

Intersection: Deer Valley Dr / Marsac Av

City, State: Park City, Utah

Control: Yields

File Name : Deer Valley Dr & Marsac Ave RDBT

Site Code : Saturday

Start Date : 12/19/2020

Page No : 7

Image 1



# L2 Data Collection

L2DataCollection.com  
Idaho (208) 860-7554 Utah (801) 413-2993

Study: FEHR0124  
Intersection: Deer Valley Dr / Bonanza  
City, State: Park City, Utah  
Control: Signalized

File Name : Deer Valley Dr & Bonanza Dr  
Site Code : Saturday  
Start Date : 12/19/2020  
Page No : 1

### Groups Printed- General Traffic

Start Time	Bonanza Drive From Northeast				Deer Valley Drive From South				Deer Valley Drive From West				Int. Total
	Bear Right	Bear Left	Peds	App. Total	Bear Right	Left	Peds	App. Total	Right	Bear Left	Peds	App. Total	
07:45 AM	34	138	0	172	21	37	0	58	137	13	0	150	380
Total	34	138	0	172	21	37	0	58	137	13	0	150	380
08:00 AM	26	111	0	137	30	42	0	72	147	8	0	155	364
08:15 AM	49	115	0	164	24	60	0	84	141	14	0	155	403
08:30 AM	51	113	0	164	23	48	0	71	137	23	0	160	395
08:45 AM	40	130	0	170	32	58	0	90	137	23	0	160	420
Total	166	469	0	635	109	208	0	317	562	68	0	630	1582
09:00 AM	28	111	0	139	49	57	0	106	120	29	0	149	394
09:15 AM	22	85	0	107	27	70	0	97	112	34	0	146	350
09:30 AM	26	90	0	116	38	54	0	92	121	30	0	151	359
-----													
Total	76	286	0	362	114	181	0	295	353	93	0	446	1103
-----													
03:30 PM	23	90	0	113	146	174	0	320	120	58	0	178	611
03:45 PM	41	110	1	152	147	184	0	331	110	67	0	177	660
Total	64	200	1	265	293	358	0	651	230	125	0	355	1271
04:00 PM	25	92	0	117	155	175	0	330	119	59	0	178	625
04:15 PM	26	103	0	129	142	177	0	319	110	63	0	173	621
04:30 PM	31	94	0	125	176	182	0	358	99	50	0	149	632
04:45 PM	17	86	0	103	130	166	0	296	121	44	0	165	564
Total	99	375	0	474	603	700	0	1303	449	216	0	665	2442
05:00 PM	21	81	0	102	136	171	0	307	110	41	0	151	560
05:15 PM	16	93	0	109	139	141	0	280	136	38	0	174	563
Grand Total	476	1642	1	2119	1415	1796	0	3211	1977	594	0	2571	7901
Apprch %	22.5	77.5	0		44.1	55.9	0		76.9	23.1	0		
Total %	6	20.8	0	26.8	17.9	22.7	0	40.6	25	7.5	0	32.5	

# L2 Data Collection

L2DataCollection.com  
 Idaho (208) 860-7554 Utah (801) 413-2993

Study: FEHR0124  
 Intersection: Deer Valley Dr / Bonanza  
 City, State: Park City, Utah  
 Control: Signalized

File Name : Deer Valley Dr & Bonanza Dr  
 Site Code : Saturday  
 Start Date : 12/19/2020  
 Page No : 2

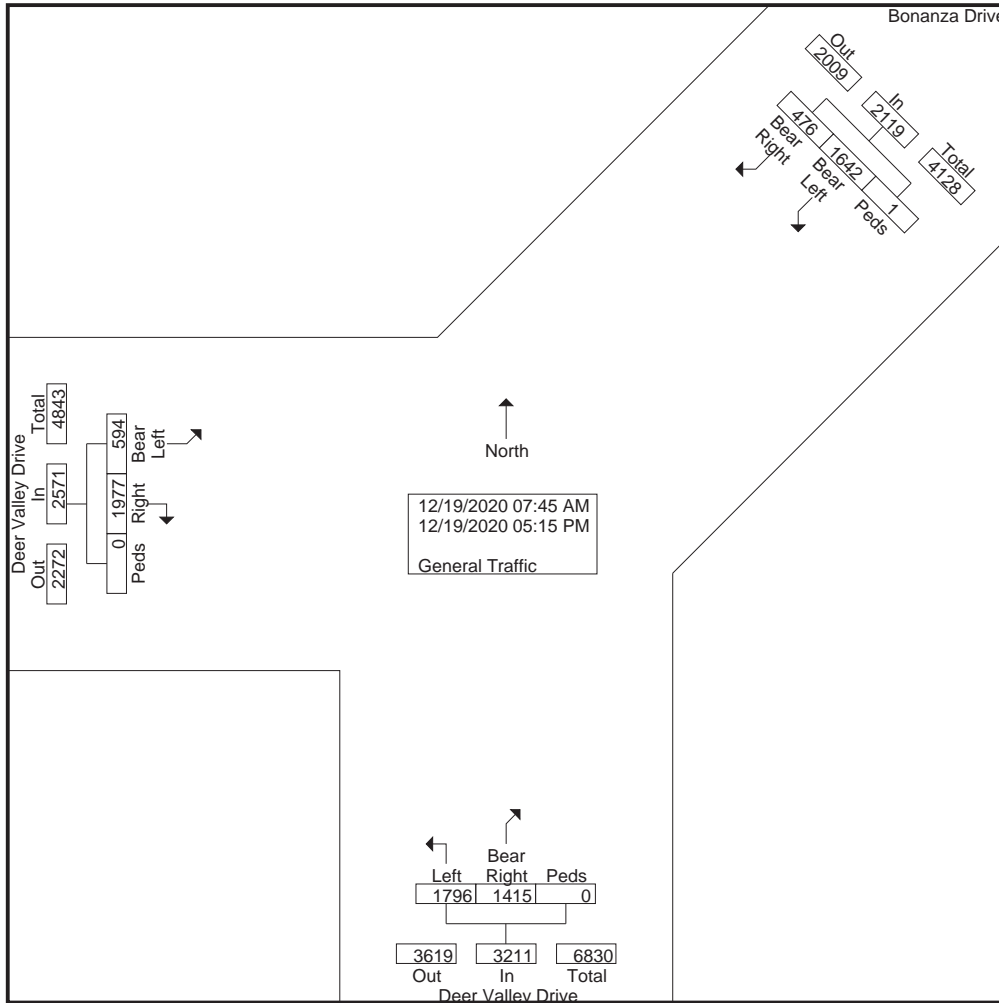



# L2 Data Collection

L2DataCollection.com  
 Idaho (208) 860-7554 Utah (801) 413-2993

Study: FEHR0124  
 Intersection: Deer Valley Dr / Bonanza  
 City, State: Park City, Utah  
 Control: Signalized

File Name : Deer Valley Dr & Bonanza Dr  
 Site Code : Saturday  
 Start Date : 12/19/2020  
 Page No : 3

Start Time	Bonanza Drive From Northeast				Deer Valley Drive From South				Deer Valley Drive From West				Int. Total
	Bear Right	Bear Left	Peds	App. Total	Bear Right	Left	Peds	App. Total	Right	Bear Left	Peds	App. Total	
<b>Peak Hour Analysis From 07:45 AM to 11:45 AM - Peak 1 of 1</b>													
Peak Hour for Entire Intersection Begins at 08:15 AM													
08:15 AM	49	115	0	164	24	<b>60</b>	0	84	<b>141</b>	14	0	155	403
08:30 AM	<b>51</b>	113	0	164	23	48	0	71	137	23	0	<b>160</b>	395
08:45 AM	40	<b>130</b>	0	<b>170</b>	32	58	0	90	137	23	0	160	<b>420</b>
09:00 AM	28	111	0	139	<b>49</b>	57	0	<b>106</b>	120	<b>29</b>	0	149	394
Total Volume	168	469	0	637	128	223	0	351	535	89	0	624	1612
% App. Total	26.4	73.6	0		36.5	63.5	0		85.7	14.3	0		
PHF	.824	.902	.000	.937	.653	.929	.000	.828	.949	.767	.000	.975	.960

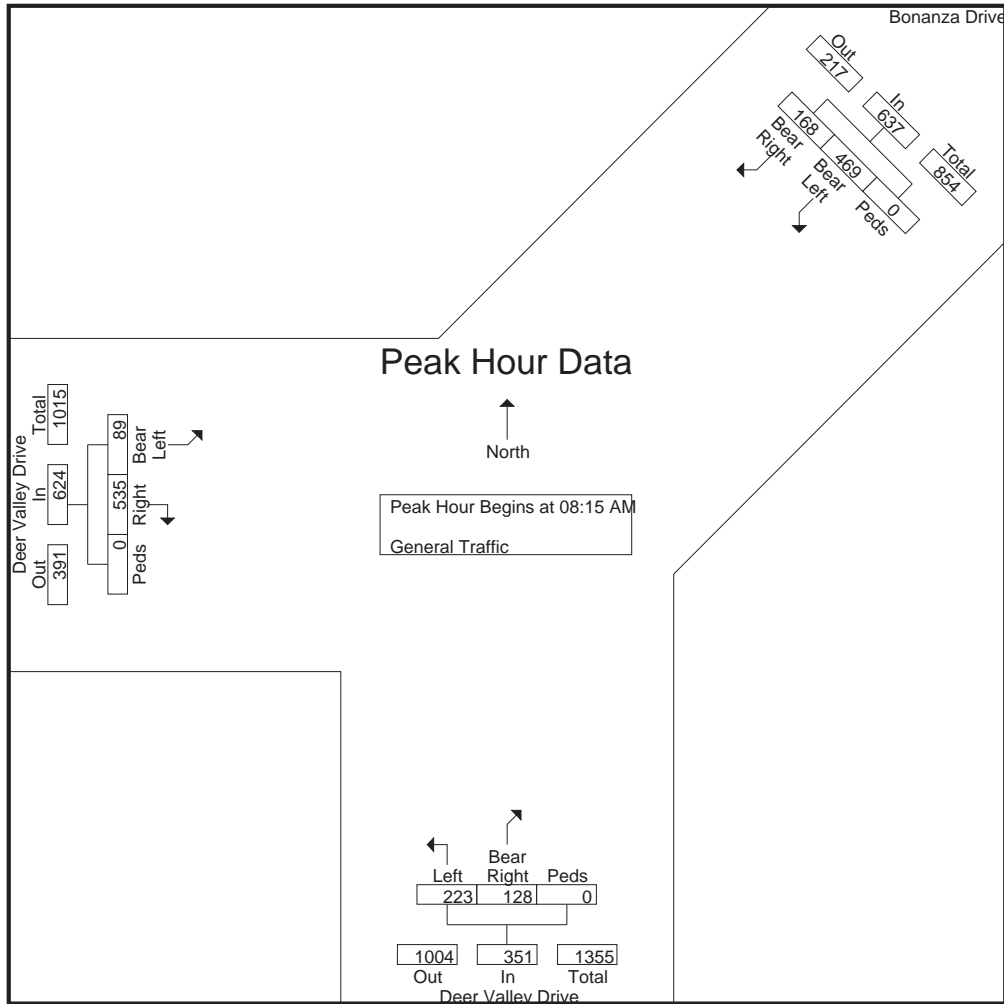

# L2 Data Collection

L2DataCollection.com  
 Idaho (208) 860-7554 Utah (801) 413-2993

Study: FEHR0124  
 Intersection: Deer Valley Dr / Bonanza  
 City, State: Park City, Utah  
 Control: Signalized

File Name : Deer Valley Dr & Bonanza Dr  
 Site Code : Saturday  
 Start Date : 12/19/2020  
 Page No : 4

Start Time	Bonanza Drive From Northeast				Deer Valley Drive From South				Deer Valley Drive From West				Int. Total
	Bear Right	Bear Left	Peds	App. Total	Bear Right	Left	Peds	App. Total	Right	Bear Left	Peds	App. Total	
<b>Peak Hour Analysis From 07:45 AM to 11:45 AM - Peak 1 of 1</b>													
<b>Peak Hour for Each Approach Begins at:</b>													
	07:45 AM				08:45 AM				08:00 AM				
+0 mins.	34	138	0	172	32	58	0	90	147	8	0	155	
+15 mins.	26	111	0	137	49	57	0	106	141	14	0	155	
+30 mins.	49	115	0	164	27	70	0	97	137	23	0	160	
+45 mins.	51	113	0	164	38	54	0	92	137	23	0	160	
Total Volume	160	477	0	637	146	239	0	385	562	68	0	630	
% App. Total	25.1	74.9	0		37.9	62.1	0		89.2	10.8	0		
PHF	.784	.864	.000	.926	.745	.854	.000	.908	.956	.739	.000	.984	

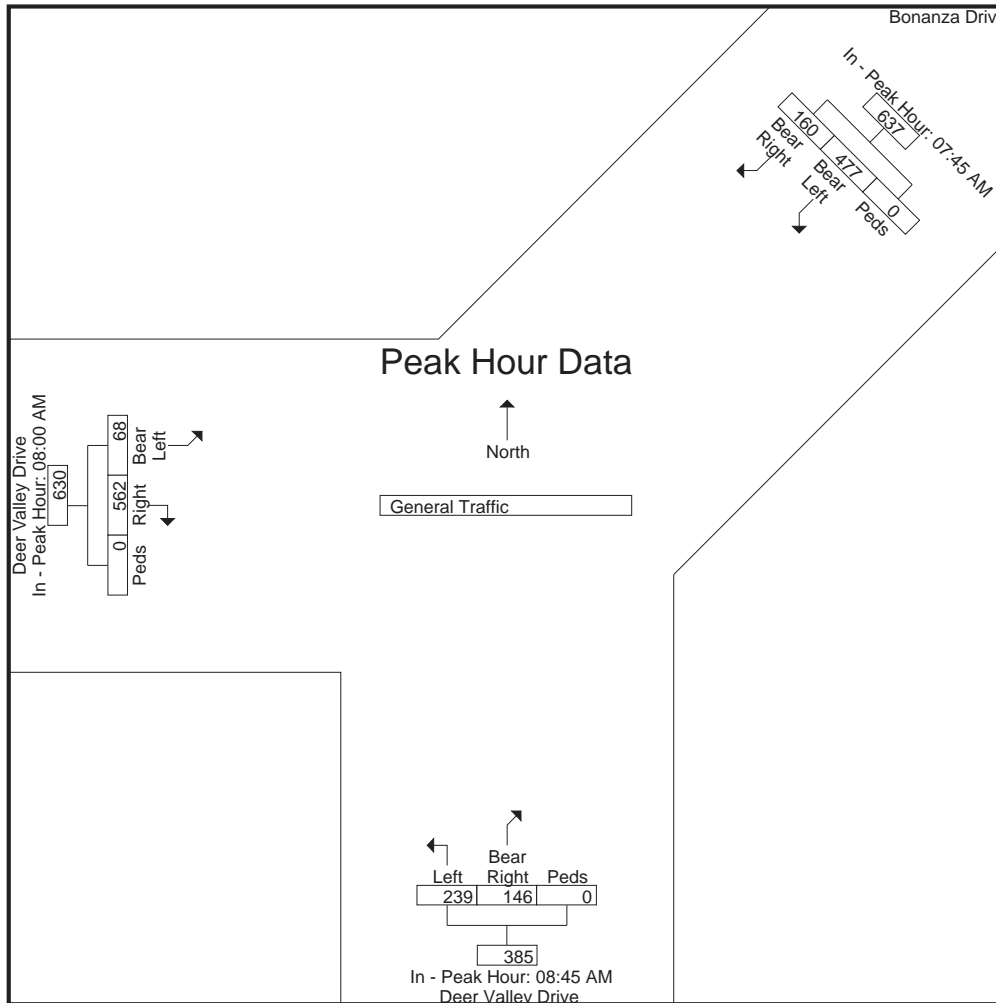

# L2 Data Collection

L2DataCollection.com  
 Idaho (208) 860-7554 Utah (801) 413-2993

Study: FEHR0124  
 Intersection: Deer Valley Dr / Bonanza  
 City, State: Park City, Utah  
 Control: Signalized

File Name : Deer Valley Dr & Bonanza Dr  
 Site Code : Saturday  
 Start Date : 12/19/2020  
 Page No : 5

Start Time	Bonanza Drive From Northeast				Deer Valley Drive From South				Deer Valley Drive From West				Int. Total
	Bear Right	Bear Left	Peds	App. Total	Bear Right	Left	Peds	App. Total	Right	Bear Left	Peds	App. Total	
<b>Peak Hour Analysis From 12:00 PM to 05:15 PM - Peak 1 of 1</b>													
Peak Hour for Entire Intersection Begins at 03:45 PM													
03:45 PM	41	110	1	152	147	184	0	331	110	67	0	177	660
04:00 PM	25	92	0	117	155	175	0	330	119	59	0	178	625
04:15 PM	26	103	0	129	142	177	0	319	110	63	0	173	621
04:30 PM	31	94	0	125	176	182	0	358	99	50	0	149	632
Total Volume	123	399	1	523	620	718	0	1338	438	239	0	677	2538
% App. Total	23.5	76.3	0.2		46.3	53.7	0		64.7	35.3	0		
PHF	.750	.907	.250	.860	.881	.976	.000	.934	.920	.892	.000	.951	.961

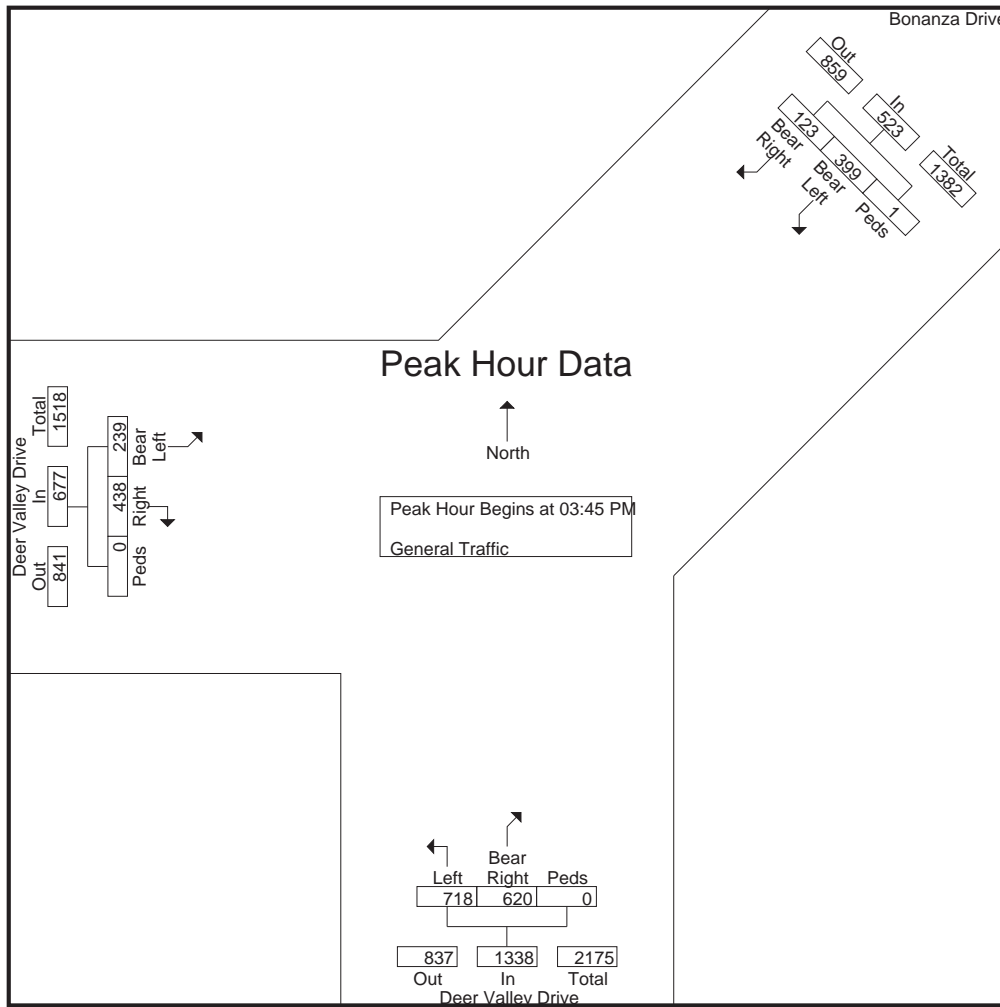

# L2 Data Collection

L2DataCollection.com  
 Idaho (208) 860-7554 Utah (801) 413-2993

Study: FEHR0124  
 Intersection: Deer Valley Dr / Bonanza  
 City, State: Park City, Utah  
 Control: Signalized

File Name : Deer Valley Dr & Bonanza Dr  
 Site Code : Saturday  
 Start Date : 12/19/2020  
 Page No : 6

Start Time	Bonanza Drive From Northeast				Deer Valley Drive From South				Deer Valley Drive From West				Int. Total
	Bear Right	Bear Left	Peds	App. Total	Bear Right	Left	Peds	App. Total	Right	Bear Left	Peds	App. Total	
<b>Peak Hour Analysis From 12:00 PM to 05:15 PM - Peak 1 of 1</b>													
<b>Peak Hour for Each Approach Begins at:</b>													
	03:45 PM				03:45 PM				03:30 PM				
+0 mins.	41	110	1	152	147	184	0	331	120	58	0	178	
+15 mins.	25	92	0	117	155	175	0	330	110	67	0	177	
+30 mins.	26	103	0	129	142	177	0	319	119	59	0	178	
+45 mins.	31	94	0	125	176	182	0	358	110	63	0	173	
Total Volume	123	399	1	523	620	718	0	1338	459	247	0	706	
% App. Total	23.5	76.3	0.2		46.3	53.7	0		65	35	0		
PHF	.750	.907	.250	.860	.881	.976	.000	.934	.956	.922	.000	.992	

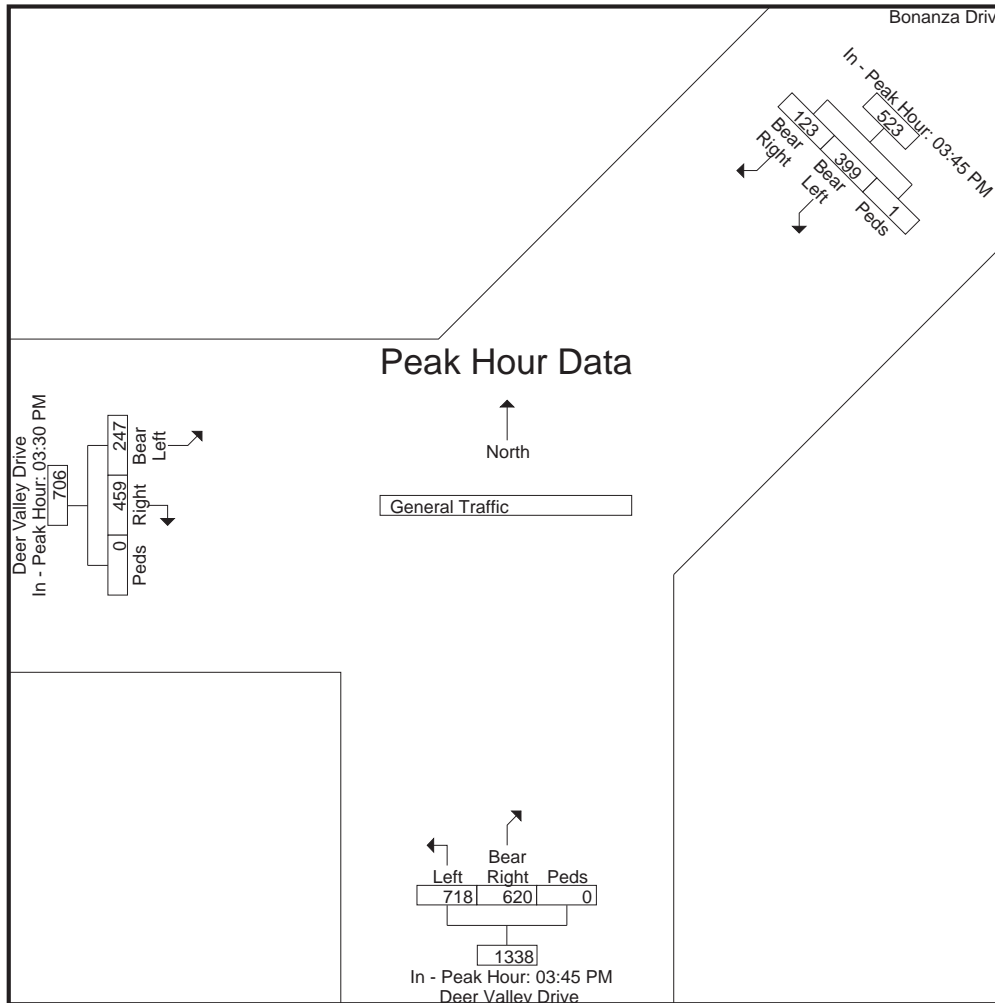

# L2 Data Collection

L2DataCollection.com

Idaho (208) 860-7554 Utah (801) 413-2993

Study: FEHR0124  
Intersection: Deer Valley Dr / Bonanza  
City, State: Park City, Utah  
Control: Signalized

File Name : Deer Valley Dr & Bonanza Dr  
Site Code : Saturday  
Start Date : 12/19/2020  
Page No : 7

Image 1







## Intersection Turning Movement Summary

<b>Intersection:</b>	Deer Valley Drive East/Queen Esther Drive	<b>Date:</b>	3-4-22, Fri
	<b>North/South:</b> Deer Valley Drive East	<b>Day of Week Adjustment:</b>	100.0%
	<b>East/West:</b> Queen Esther Drive	<b>Month of Year Adjustment:</b>	100.0%
<b>Jurisdiction:</b>	Park City	<b>Adjustment Station #:</b>	
<b>Project Title:</b>	Snow Park Development	<b>Growth Rate:</b>	0.0%
<b>Project No:</b>	UT20-2245	<b>Number of Years:</b>	0
<b>Weather:</b>			

AM PEAK HOUR PERIOD: **8:45-9:45**  
 AM PEAK 15 MINUTE PERIOD: **8:45-9:00**  
 AM PHF: **0.77**

NOON PEAK HOUR PERIOD:  
 NOON PEAK 15 MINUTE PERIOD:  
 NOON PHF: **####**

PM PEAK HOUR PERIOD: **15:30-16:30**  
 PM PEAK 15 MINUTE PERIOD: **16:00-16:15**  
 PM PHF: **0.94**

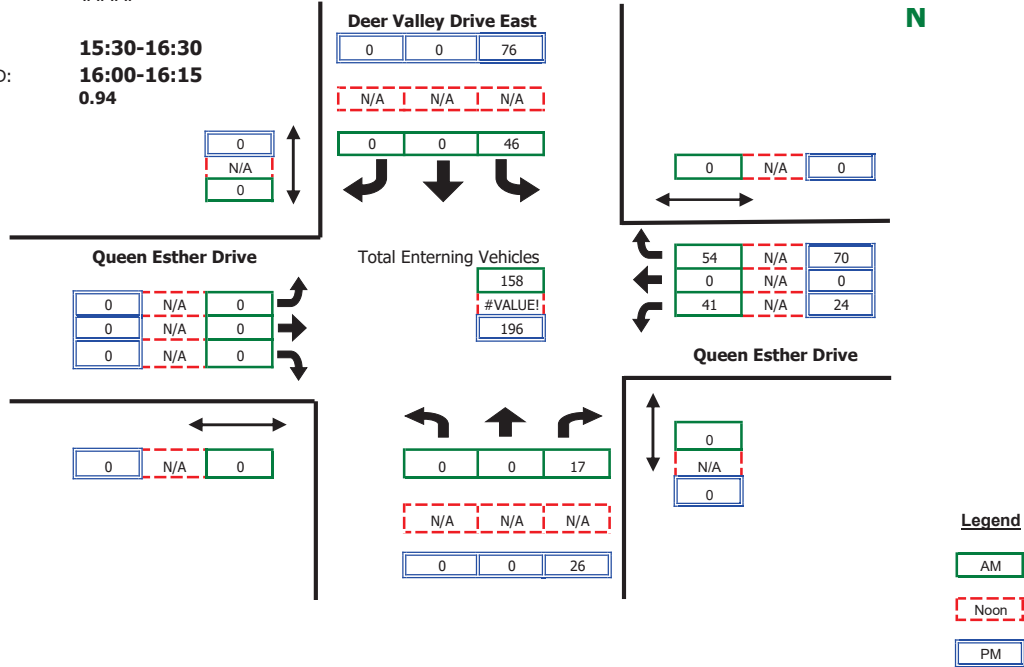

RAW COUNT SUMMARIES	Deer Valley Drive East Northbound				Deer Valley Drive East Southbound				Queen Esther Drive Eastbound				Queen Esther Drive Westbound			
	Left	Thru	Right	Peds	Left	Thru	Right	Peds	Left	Thru	Right	Peds	Left	Thru	Right	Peds

AM PERIOD COUNTS																	
Period	A	B	C	D	E	F	G	H	I	J	K	L	M	N	O	P	TOTAL
8:00-8:15	0	0	4	0	12	0	0	0	0	0	0	0	3	0	18	0	37
8:15-8:30	0	0	3	0	11	0	0	0	0	0	0	0	10	0	9	0	33
8:30-8:45	0	0	5	0	11	0	0	0	0	0	0	0	6	0	10	0	32
8:45-9:00	0	0	2	0	16	0	0	0	0	0	0	0	13	0	20	0	51
9:00-9:15	0	0	5	0	5	0	0	0	0	0	0	0	7	0	9	0	26
9:15-9:30	0	0	6	0	10	0	0	0	0	0	0	0	5	0	10	0	31
9:30-9:45	0	0	4	0	15	0	0	0	0	0	0	0	16	0	15	0	50
9:45-10:00	0	0	10	0	10	0	0	0	0	0	0	0	7	0	15	0	42

NOON PERIOD COUNTS																	
Period	A	B	C	D	E	F	G	H	I	J	K	L	M	N	O	P	TOTAL
14:00-14:15	0	0	0	0	0	0	0	0	0	0	0	0	0	0	0	0	0
14:15-14:30	0	0	0	0	0	0	0	0	0	0	0	0	0	0	0	0	0
14:30-14:45	0	0	0	0	0	0	0	0	0	0	0	0	0	0	0	0	0
14:45-15:00	0	0	0	0	0	0	0	0	0	0	0	0	0	0	0	0	0
15:00-15:15	0	0	0	0	0	0	0	0	0	0	0	0	0	0	0	0	0
15:15-15:30	0	0	0	0	0	0	0	0	0	0	0	0	0	0	0	0	0
15:30-15:45	0	0	0	0	0	0	0	0	0	0	0	0	0	0	0	0	0
15:45-14:00	0	0	0	0	0	0	0	0	0	0	0	0	0	0	0	0	0

PM PERIOD COUNTS																	
Period	A	B	C	D	E	F	G	H	I	J	K	L	M	N	O	P	TOTAL
14:30-14:45	0	0	6	0	14	0	0	0	0	0	0	0	5	0	9	0	34
14:45-15:00	0	0	8	0	19	0	0	0	0	0	0	0	6	0	23	0	56
15:00-15:15	0	0	8	0	11	0	0	0	0	0	0	0	8	0	18	0	45
15:15-15:30	0	0	8	0	16	0	0	0	0	0	0	0	7	0	15	0	46
15:30-15:45	0	0	2	0	10	0	0	0	0	0	0	0	8	0	21	0	41
15:45-16:00	0	0	7	0	26	0	0	0	0	0	0	0	3	0	15	0	51
16:00-16:15	0	0	7	0	18	0	0	0	0	0	0	0	7	0	20	0	52
16:15-16:30	0	0	10	0	22	0	0	0	0	0	0	0	6	0	14	0	52

## Intersection Turning Movement Summary

<b>Intersection:</b>	Deer Valley Drive East/Queen Esther Drive	<b>Date:</b>	3-5-22, Sat
	North/South: Deer Valley Drive East	<b>Day of Week Adjustment:</b>	100.0%
	East/West: Queen Esther Drive	<b>Month of Year Adjustment:</b>	100.0%
<b>Jurisdiction:</b>	Park City	<b>Adjustment Station #:</b>	
<b>Project Title:</b>	Snow Park Development	<b>Growth Rate:</b>	0.0%
<b>Project No:</b>	UT20-2245	<b>Number of Years:</b>	0
<b>Weather:</b>			

AM PEAK HOUR PERIOD: **8:45-9:45**  
 AM PEAK 15 MINUTE PERIOD: **8:45-9:00**  
 AM PHF: **0.86**

NOON PEAK HOUR PERIOD:  
 NOON PEAK 15 MINUTE PERIOD:  
 NOON PHF: **####**

PM PEAK HOUR PERIOD: **15:30-16:30**  
 PM PEAK 15 MINUTE PERIOD: **16:15-16:30**  
 PM PHF: **0.68**

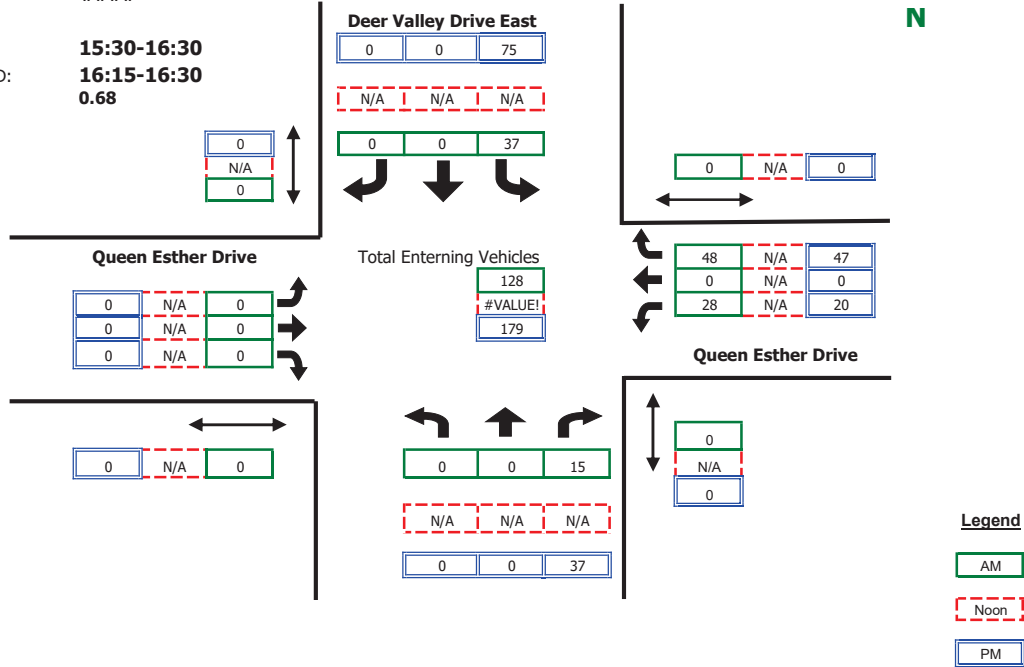

RAW COUNT SUMMARIES	Deer Valley Drive East Northbound				Deer Valley Drive East Southbound				Queen Esther Drive Eastbound				Queen Esther Drive Westbound				TOTAL
	Left	Thru	Right	Peds	Left	Thru	Right	Peds	Left	Thru	Right	Peds	Left	Thru	Right	Peds	

AM PERIOD COUNTS																	
Period	A	B	C	D	E	F	G	H	I	J	K	L	M	N	O	P	TOTAL
8:00-8:15	0	0	6	0	10	0	0	0	0	0	0	0	4	0	4	0	24
8:15-8:30	0	0	1	0	7	0	0	0	0	0	0	0	10	0	4	0	22
8:30-8:45	0	0	7	0	6	0	0	0	0	0	0	0	10	0	10	0	33
8:45-9:00	0	0	5	0	12	0	0	0	0	0	0	0	10	0	10	0	37
9:00-9:15	0	0	4	0	9	0	0	0	0	0	0	0	6	0	10	0	29
9:15-9:30	0	0	3	0	10	0	0	0	0	0	0	0	4	0	9	0	26
9:30-9:45	0	0	3	0	6	0	0	0	0	0	0	0	8	0	19	0	36
9:45-10:00	0	0	4	0	10	0	0	0	0	0	0	0	7	0	9	0	30

NOON PERIOD COUNTS																	
Period	A	B	C	D	E	F	G	H	I	J	K	L	M	N	O	P	TOTAL
14:00-14:15	0	0	0	0	0	0	0	0	0	0	0	0	0	0	0	0	0
14:15-14:30	0	0	0	0	0	0	0	0	0	0	0	0	0	0	0	0	0
14:30-14:45	0	0	0	0	0	0	0	0	0	0	0	0	0	0	0	0	0
14:45-15:00	0	0	0	0	0	0	0	0	0	0	0	0	0	0	0	0	0
15:00-15:15	0	0	0	0	0	0	0	0	0	0	0	0	0	0	0	0	0
15:15-15:30	0	0	0	0	0	0	0	0	0	0	0	0	0	0	0	0	0
15:30-15:45	0	0	0	0	0	0	0	0	0	0	0	0	0	0	0	0	0
15:45-14:00	0	0	0	0	0	0	0	0	0	0	0	0	0	0	0	0	0

PM PERIOD COUNTS																	
Period	A	B	C	D	E	F	G	H	I	J	K	L	M	N	O	P	TOTAL
14:30-14:45	0	0	7	0	23	0	0	0	0	0	0	0	4	0	10	0	44
14:45-15:00	0	0	4	0	16	0	0	0	0	0	0	0	7	0	15	0	42
15:00-15:15	0	0	2	0	9	0	0	0	0	0	0	0	6	0	7	0	24
15:15-15:30	0	0	4	0	12	0	0	0	0	0	0	0	2	0	11	0	29
15:30-15:45	0	0	6	0	14	0	0	0	0	0	0	0	7	0	9	0	36
15:45-16:00	0	0	5	0	14	0	0	0	0	0	0	0	4	0	11	0	34
16:00-16:15	0	0	11	0	16	0	0	0	0	0	0	0	6	0	10	0	43
16:15-16:30	0	0	15	0	31	0	0	0	0	0	0	0	3	0	17	0	66

## Intersection Turning Movement Summary

<b>Intersection:</b>	Solamere Drive/Deer Valley Drive East	<b>Date:</b>	3-3-22, Thu
	North/South: Solamere Drive	<b>Day of Week Adjustment:</b>	100.0%
	East/West: Deer Valley Drive East	<b>Month of Year Adjustment:</b>	100.0%
<b>Jurisdiction:</b>	Park City	<b>Adjustment Station #:</b>	
<b>Project Title:</b>	Snow Park Development	<b>Growth Rate:</b>	0.0%
<b>Project No:</b>	UT20-2245	<b>Number of Years:</b>	0
<b>Weather:</b>			

AM PEAK HOUR PERIOD: **8:30-9:30**  
 AM PEAK 15 MINUTE PERIOD: **8:30-8:45**  
 AM PHF: **0.83**

NOON PEAK HOUR PERIOD:  
 NOON PEAK 15 MINUTE PERIOD:  
 NOON PHF: **####**

PM PEAK HOUR PERIOD: **15:30-16:30**  
 PM PEAK 15 MINUTE PERIOD: **15:30-15:45**  
 PM PHF: **0.96**

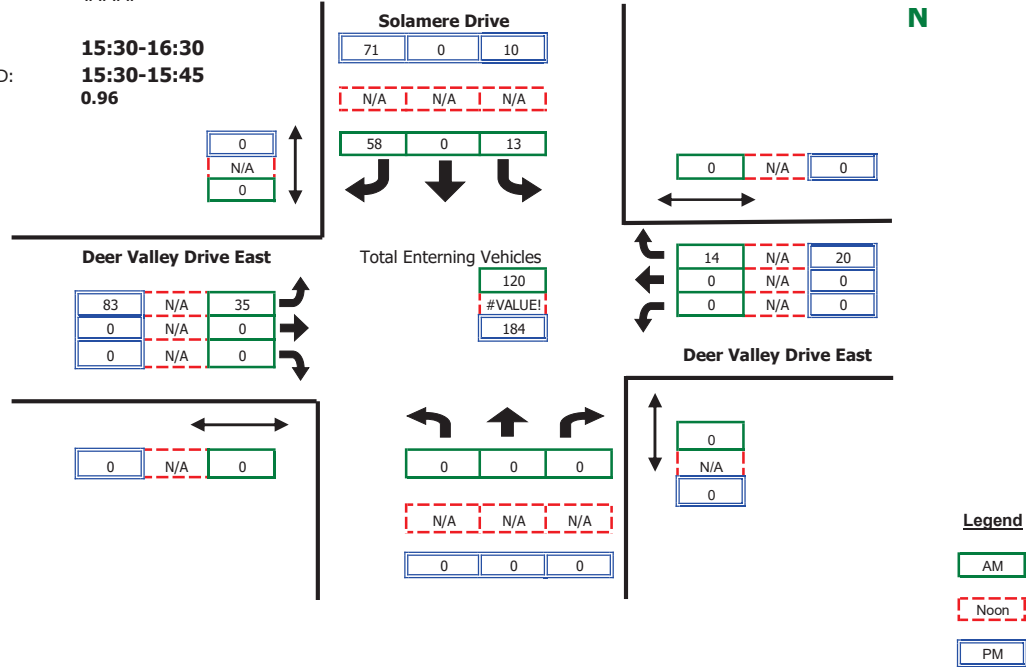

RAW COUNT SUMMARIES	Solamere Drive Northbound				Solamere Drive Southbound				Deer Valley Drive East Eastbound				Deer Valley Drive East Westbound			
	Left	Thru	Right	Peds	Left	Thru	Right	Peds	Left	Thru	Right	Peds	Left	Thru	Right	Peds

AM PERIOD COUNTS																	
Period	A	B	C	D	E	F	G	H	I	J	K	L	M	N	O	P	TOTAL
8:00-8:15	0	0	0	0	4	0	7	0	11	0	0	0	0	0	0	0	22
8:15-8:30	0	0	0	0	2	0	10	0	10	0	0	0	0	0	1	0	23
8:30-8:45	0	0	0	0	2	0	24	0	7	0	0	0	0	0	3	0	36
8:45-9:00	0	0	0	0	4	0	12	0	9	0	0	0	0	0	3	0	28
9:00-9:15	0	0	0	0	3	0	12	0	7	0	0	0	0	0	5	0	27
9:15-9:30	0	0	0	0	4	0	10	0	12	0	0	0	0	0	3	0	29
9:30-9:45	0	0	0	0	1	0	10	0	17	0	0	0	0	0	3	0	31
9:45-10:00	0	0	0	0	4	0	8	0	9	0	0	0	0	0	4	0	25

NOON PERIOD COUNTS																	
Period	A	B	C	D	E	F	G	H	I	J	K	L	M	N	O	P	TOTAL
14:00-14:15	0	0	0	0	0	0	0	0	0	0	0	0	0	0	0	0	0
14:15-14:30	0	0	0	0	0	0	0	0	0	0	0	0	0	0	0	0	0
14:30-14:45	0	0	0	0	0	0	0	0	0	0	0	0	0	0	0	0	0
14:45-15:00	0	0	0	0	0	0	0	0	0	0	0	0	0	0	0	0	0
15:00-15:15	0	0	0	0	0	0	0	0	0	0	0	0	0	0	0	0	0
15:15-15:30	0	0	0	0	0	0	0	0	0	0	0	0	0	0	0	0	0
15:30-15:45	0	0	0	0	0	0	0	0	0	0	0	0	0	0	0	0	0
15:45-14:00	0	0	0	0	0	0	0	0	0	0	0	0	0	0	0	0	0

PM PERIOD COUNTS																	
Period	A	B	C	D	E	F	G	H	I	J	K	L	M	N	O	P	TOTAL
14:30-14:45	0	0	0	0	3	0	23	0	16	0	0	0	0	0	6	0	48
14:45-15:00	0	0	0	0	2	0	17	0	16	0	0	0	0	0	4	0	39
15:00-15:15	0	0	0	0	1	0	20	0	19	0	0	0	0	0	3	0	43
15:15-15:30	0	0	0	0	5	0	17	0	18	0	0	0	0	0	7	0	47
15:30-15:45	0	0	0	0	3	0	24	0	14	0	0	0	0	0	7	0	48
15:45-16:00	0	0	0	0	2	0	15	0	25	0	0	0	0	0	2	0	44
16:00-16:15	0	0	0	0	5	0	15	0	20	0	0	0	0	0	4	0	44
16:15-16:30	0	0	0	0	0	0	17	0	24	0	0	0	0	0	7	0	48

## Intersection Turning Movement Summary

<b>Intersection:</b>	<b>Solamere Drive/Deer Valley Drive East</b>	<b>Date:</b>	<b>3-4-22, Fri</b>
<b>North/South:</b>	<b>Solamere Drive</b>	<b>Day of Week Adjustment:</b>	<b>100.0%</b>
<b>East/West:</b>	<b>Deer Valley Drive East</b>	<b>Month of Year Adjustment:</b>	<b>100.0%</b>
<b>Jurisdiction:</b>	<b>Park City</b>	<b>Adjustment Station #:</b>	
<b>Project Title:</b>	<b>Snow Park Development</b>	<b>Growth Rate:</b>	<b>0.0%</b>
<b>Project No:</b>	<b>UT20-2245</b>	<b>Number of Years:</b>	<b>0</b>
<b>Weather:</b>			

AM PEAK HOUR PERIOD: **8:45-9:45**  
 AM PEAK 15 MINUTE PERIOD: **9:15-9:30**  
 AM PHF: **0.93**

NOON PEAK HOUR PERIOD:  
 NOON PEAK 15 MINUTE PERIOD:  
 NOON PHF: **####**

PM PEAK HOUR PERIOD: **15:30-16:30**  
 PM PEAK 15 MINUTE PERIOD: **15:30-15:45**  
 PM PHF: **0.89**

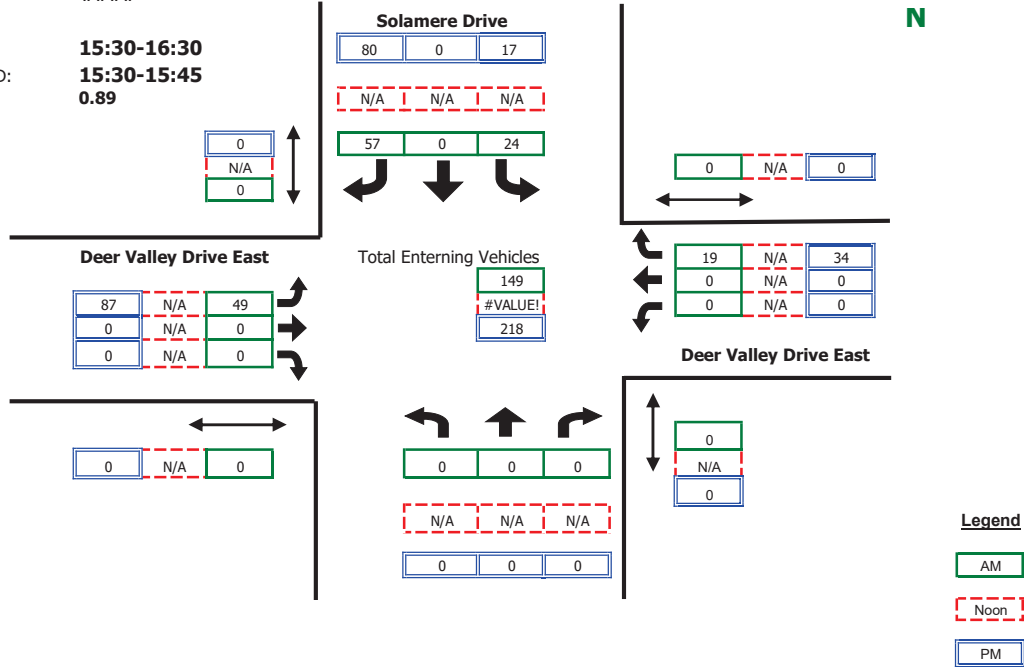

RAW COUNT SUMMARIES	Solamere Drive Northbound				Solamere Drive Southbound				Deer Valley Drive East Eastbound				Deer Valley Drive East Westbound			
	Left	Thru	Right	Peds	Left	Thru	Right	Peds	Left	Thru	Right	Peds	Left	Thru	Right	Peds

AM PERIOD COUNTS																	
Period	A	B	C	D	E	F	G	H	I	J	K	L	M	N	O	P	TOTAL
8:00-8:15	0	0	0	0	2	0	6	0	6	0	0	0	0	0	1	0	15
8:15-8:30	0	0	0	0	5	0	13	0	9	0	0	0	0	0	2	0	29
8:30-8:45	0	0	0	0	7	0	8	0	9	0	0	0	0	0	2	0	26
8:45-9:00	0	0	0	0	8	0	11	0	11	0	0	0	0	0	7	0	37
9:00-9:15	0	0	0	0	6	0	13	0	11	0	0	0	0	0	3	0	33
9:15-9:30	0	0	0	0	4	0	17	0	16	0	0	0	0	0	3	0	40
9:30-9:45	0	0	0	0	6	0	16	0	11	0	0	0	0	0	6	0	39
9:45-10:00	0	0	0	0	4	0	19	0	10	0	0	0	0	0	2	0	35

NOON PERIOD COUNTS																	
Period	A	B	C	D	E	F	G	H	I	J	K	L	M	N	O	P	TOTAL
14:00-14:15	0	0	0	0	0	0	0	0	0	0	0	0	0	0	0	0	0
14:15-14:30	0	0	0	0	0	0	0	0	0	0	0	0	0	0	0	0	0
14:30-14:45	0	0	0	0	0	0	0	0	0	0	0	0	0	0	0	0	0
14:45-15:00	0	0	0	0	0	0	0	0	0	0	0	0	0	0	0	0	0
15:00-15:15	0	0	0	0	0	0	0	0	0	0	0	0	0	0	0	0	0
15:15-15:30	0	0	0	0	0	0	0	0	0	0	0	0	0	0	0	0	0
15:30-15:45	0	0	0	0	0	0	0	0	0	0	0	0	0	0	0	0	0
15:45-14:00	0	0	0	0	0	0	0	0	0	0	0	0	0	0	0	0	0

PM PERIOD COUNTS																	
Period	A	B	C	D	E	F	G	H	I	J	K	L	M	N	O	P	TOTAL
14:30-14:45	0	0	0	0	0	0	21	0	15	0	0	0	0	0	1	0	37
14:45-15:00	0	0	0	0	6	0	11	0	20	0	0	0	0	0	1	0	38
15:00-15:15	0	0	0	0	2	0	16	0	17	0	0	0	0	0	7	0	42
15:15-15:30	0	0	0	0	4	0	15	0	19	0	0	0	0	0	1	0	39
15:30-15:45	0	0	0	0	5	0	24	0	20	0	0	0	0	0	12	0	61
15:45-16:00	0	0	0	0	3	0	16	0	17	0	0	0	0	0	5	0	41
16:00-16:15	0	0	0	0	4	0	21	0	21	0	0	0	0	0	8	0	54
16:15-16:30	0	0	0	0	5	0	19	0	29	0	0	0	0	0	9	0	62

## Intersection Turning Movement Summary

<b>Intersection:</b>	Solamere Drive/Deer Valley Drive East	<b>Date:</b>	3-5-22, Sat
	North/South: Solamere Drive	<b>Day of Week Adjustment:</b>	100.0%
	East/West: Deer Valley Drive East	<b>Month of Year Adjustment:</b>	100.0%
<b>Jurisdiction:</b>	Park City	<b>Adjustment Station #:</b>	
<b>Project Title:</b>	Snow Park Development	<b>Growth Rate:</b>	0.0%
<b>Project No:</b>	UT20-2245	<b>Number of Years:</b>	0
<b>Weather:</b>			

AM PEAK HOUR PERIOD: **9:00-10:00**  
 AM PEAK 15 MINUTE PERIOD: **9:45-10:00**  
 AM PHF: **0.76**

NOON PEAK HOUR PERIOD:  
 NOON PEAK 15 MINUTE PERIOD:  
 NOON PHF: **####**

PM PEAK HOUR PERIOD: **15:30-16:30**  
 PM PEAK 15 MINUTE PERIOD: **15:30-15:45**  
 PM PHF: **1.29**

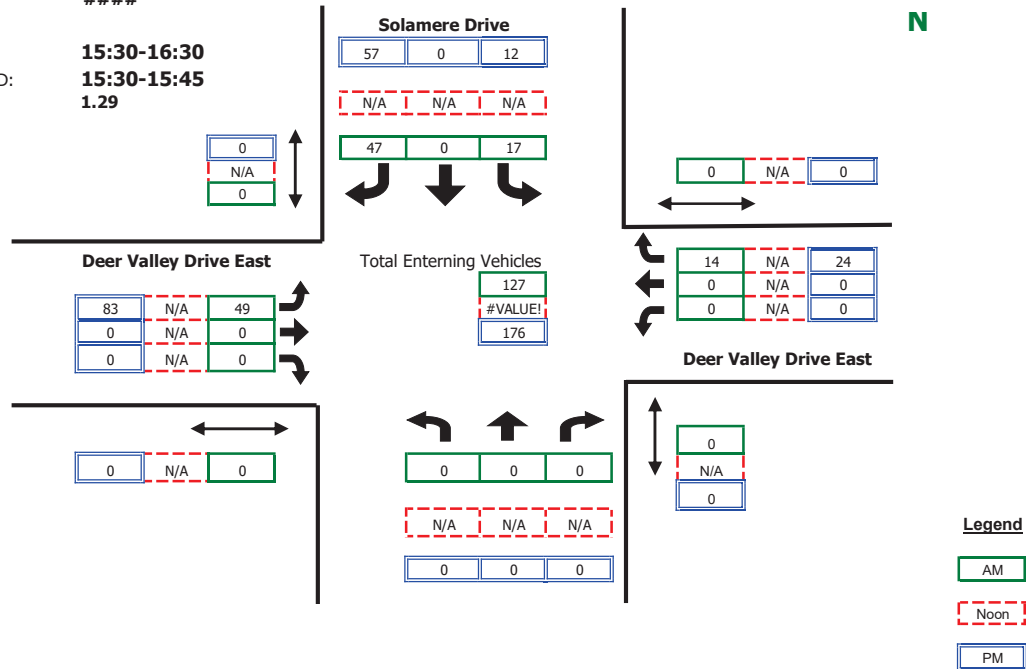

RAW COUNT SUMMARIES	Solamere Drive Northbound				Solamere Drive Southbound				Deer Valley Drive East Eastbound				Deer Valley Drive East Westbound			
	Left	Thru	Right	Peds	Left	Thru	Right	Peds	Left	Thru	Right	Peds	Left	Thru	Right	Peds

AM PERIOD COUNTS																	
Period	A	B	C	D	E	F	G	H	I	J	K	L	M	N	O	P	TOTAL
8:00-8:15	0	0	0	0	2	0	12	0	4	0	0	0	0	0	2	0	20
8:15-8:30	0	0	0	0	5	0	6	0	5	0	0	0	0	0	1	0	17
8:30-8:45	0	0	0	0	9	0	15	0	8	0	0	0	0	0	0	0	32
8:45-9:00	0	0	0	0	6	0	15	0	4	0	0	0	0	0	6	0	31
9:00-9:15	0	0	0	0	5	0	4	0	8	0	0	0	0	0	2	0	19
9:15-9:30	0	0	0	0	1	0	12	0	13	0	0	0	0	0	5	0	31
9:30-9:45	0	0	0	0	8	0	9	0	14	0	0	0	0	0	4	0	35
9:45-10:00	0	0	0	0	3	0	22	0	14	0	0	0	0	0	3	0	42

NOON PERIOD COUNTS																	
Period	A	B	C	D	E	F	G	H	I	J	K	L	M	N	O	P	TOTAL
14:00-14:15	0	0	0	0	0	0	0	0	0	0	0	0	0	0	0	0	0
14:15-14:30	0	0	0	0	0	0	0	0	0	0	0	0	0	0	0	0	0
14:30-14:45	0	0	0	0	0	0	0	0	0	0	0	0	0	0	0	0	0
14:45-15:00	0	0	0	0	0	0	0	0	0	0	0	0	0	0	0	0	0
15:00-15:15	0	0	0	0	0	0	0	0	0	0	0	0	0	0	0	0	0
15:15-15:30	0	0	0	0	0	0	0	0	0	0	0	0	0	0	0	0	0
15:30-15:45	0	0	0	0	0	0	0	0	0	0	0	0	0	0	0	0	0
15:45-14:00	0	0	0	0	0	0	0	0	0	0	0	0	0	0	0	0	0

PM PERIOD COUNTS																	
Period	A	B	C	D	E	F	G	H	I	J	K	L	M	N	O	P	TOTAL
14:30-14:45	0	0	0	0	4	0	9	0	17	0	0	0	0	0	6	0	36
14:45-15:00	0	0	0	0	3	0	12	0	2	0	0	0	0	0	2	0	19
15:00-15:15	0	0	0	0	3	0	8	0	7	0	0	0	0	0	7	0	25
15:15-15:30	0	0	0	0	2	0	11	0	16	0	0	0	0	0	1	0	30
15:30-15:45	0	0	0	0	2	0	11	0	17	0	0	0	0	0	4	0	34
15:45-16:00	0	0	0	0	5	0	13	0	20	0	0	0	0	0	10	0	48
16:00-16:15	0	0	0	0	3	0	15	0	25	0	0	0	0	0	9	0	52
16:15-16:30	0	0	0	0	2	0	18	0	21	0	0	0	0	0	1	0	42

**SimTraffic Post-Processor**  
**Average Results from 10 Runs**  
**Volume and Delay by Movement**

**Snow Park Village**  
**Existing**  
**AM Peak Hour**

**Intersection 3**                      **Deer Valley Drive East/Queen Esther Drive**                      **Side-street Stop**

Direction	Movement	Demand Volume (vph)	Served Volume (vph)		Total Delay (sec/veh)		
			Average	Percent	Average	Std. Dev.	LOS
NB	Left Turn						
	Through	70	74	105.4%	0.3	0.2	A
	Right Turn	17	19	112.4%	0.3	0.6	A
	Subtotal	87	93	106.8%	0.3	0.2	A
SB	Left Turn	50	50	99.4%	4.1	0.3	A
	Through	116	116	99.6%	0.9	0.3	A
	Right Turn						
	Subtotal	166	165	99.5%	1.8	0.4	A
EB	Left Turn						
	Through						
	Right Turn						
	Subtotal						
WB	Left Turn	20	18	91.0%	5.8	1.2	A
	Through						
	Right Turn	55	56	101.6%	5.2	0.6	A
	Subtotal	75	74	98.8%	5.4	0.5	A
<b>Total</b>		<b>328</b>	<b>332</b>	<b>101.3%</b>	<b>2.3</b>	<b>0.3</b>	<b>A</b>

**Intersection 4**                      **Solamere Drive/Deer Valley Drive East**                      **Side-street Stop**

Direction	Movement	Demand Volume (vph)	Served Volume (vph)		Total Delay (sec/veh)		
			Average	Percent	Average	Std. Dev.	LOS
NB	Left Turn						
	Through						
	Right Turn						
	Subtotal						
SB	Left Turn	24	23	95.4%	6.8	2.3	A
	Through						
	Right Turn	57	60	104.6%	5.8	0.4	A
	Subtotal	81	83	101.9%	5.9	0.4	A
EB	Left Turn	49	49	100.0%	4.2	0.8	A
	Through	142	144	101.1%	1.3	0.4	A
	Right Turn						
	Subtotal	191	193	100.8%	2.0	0.5	A
WB	Left Turn						
	Through	106	108	101.7%	1.1	0.2	A
	Right Turn	19	21	110.0%	1.3	0.6	A
	Subtotal	125	129	103.0%	1.1	0.2	A
<b>Total</b>		<b>397</b>	<b>404</b>	<b>101.7%</b>	<b>2.6</b>	<b>0.2</b>	<b>A</b>



**SimTraffic Post-Processor**  
**Average Results from 10 Runs**  
**Volume and Delay by Movement**

**Snow Park Village**  
**Existing**  
**AM Peak Hour**

**Intersection 5**                      **Deer Valley Drive West/Deer Valley Drive East**                      **Side-street Stop**

Direction	Movement	Demand Volume (vph)	Served Volume (vph)		Total Delay (sec/veh)		
			Average	Percent	Average	Std. Dev.	LOS
NB	Left Turn						
	Through	147	148	100.6%	1.1	0.6	A
	Right Turn	15	15	98.7%	1.0	1.7	A
	Subtotal	162	163	100.4%	1.1	0.5	A
SB	Left Turn	176	176	100.2%	5.3	0.9	A
	Through	627	645	102.9%	3.7	0.6	A
	Right Turn						
	Subtotal	803	822	102.3%	4.0	0.6	A
EB	Left Turn						
	Through						
	Right Turn						
	Subtotal						
WB	Left Turn	7	7	97.1%	15.3	8.3	C
	Through						
	Right Turn	156	161	103.2%	4.2	0.9	A
	Subtotal	163	168	102.9%	4.9	0.8	A
<b>Total</b>		<b>1,128</b>	<b>1,152</b>	<b>102.1%</b>	<b>3.8</b>	<b>0.5</b>	<b>A</b>

**Intersection 7**                      **Deer Valley Drive/Bonanza Drive**                      **Signal**

Direction	Movement	Demand Volume (vph)	Served Volume (vph)		Total Delay (sec/veh)		
			Average	Percent	Average	Std. Dev.	LOS
NB	Left Turn						
	Through	263	266	101.2%	13.0	2.4	B
	Right Turn	151	158	104.8%	3.7	0.8	A
	Subtotal	414	424	102.5%	9.5	1.7	A
SB	Left Turn	105	101	96.4%	12.9	1.8	B
	Through	631	635	100.7%	8.9	1.2	A
	Right Turn						
	Subtotal	736	737	100.1%	9.4	1.1	A
EB	Left Turn						
	Through						
	Right Turn						
	Subtotal						
WB	Left Turn	553	558	101.0%	15.8	1.5	B
	Through						
	Right Turn	198	196	98.7%	5.4	1.5	A
	Subtotal	751	754	100.4%	13.0	1.5	B
<b>Total</b>		<b>1,901</b>	<b>1,915</b>	<b>100.7%</b>	<b>10.8</b>	<b>1.0</b>	<b>B</b>

SimTraffic Post-Processor  
Average Results from 10 Runs  
Volume and Delay by Movement

Snow Park Village  
Existing  
AM Peak Hour

Intersection 8 SR-224-Park Avenue/Empire Avenue-Deer Valley Drive Signal

Direction	Movement	Demand Volume (vph)	Served Volume (vph)		Total Delay (sec/veh)		
			Average	Percent	Average	Std. Dev.	LOS
NB	Left Turn	36	35	96.1%	32.0	10.4	C
	Through	191	196	102.4%	52.3	3.8	D
	Right Turn	67	74	110.0%	17.5	6.3	B
	Subtotal	294	304	103.3%	42.7	4.9	D
SB	Left Turn	477	429	90.0%	206.7	15.7	F
	Through	169	154	90.8%	173.8	18.6	F
	Right Turn	901	853	94.6%	62.6	9.2	E
	Subtotal	1,547	1,436	92.8%	117.7	10.8	F
EB	Left Turn	320	316	98.7%	40.5	6.2	D
	Through	172	175	101.7%	26.9	8.7	C
	Right Turn	16	17	104.4%	19.7	18.3	B
	Subtotal	508	508	99.9%	35.2	5.4	D
WB	Left Turn	50	49	98.2%	53.8	9.2	D
	Through	253	281	110.9%	42.0	6.4	D
	Right Turn	215	215	99.9%	8.4	1.3	A
	Subtotal	518	545	105.1%	29.9	4.1	C
Total		2,867	2,791	97.4%	77.1	4.5	E

Intersection 9 Monitor Drive-Bonanza Drive/SR-248 Signal

Direction	Movement	Demand Volume (vph)	Served Volume (vph)		Total Delay (sec/veh)		
			Average	Percent	Average	Std. Dev.	LOS
NB	Left Turn	64	64	99.8%	22.0	4.6	C
	Through	28	30	106.4%	23.3	7.8	C
	Right Turn	101	100	98.9%	3.2	0.9	A
	Subtotal	193	194	100.3%	12.7	2.6	B
SB	Left Turn	54	54	100.6%	16.7	4.9	B
	Through	71	71	99.4%	26.4	5.1	C
	Right Turn	29	30	101.7%	4.3	1.0	A
	Subtotal	154	154	100.3%	18.4	3.0	B
EB	Left Turn	22	20	92.7%	12.9	3.6	B
	Through	230	234	101.6%	16.4	2.4	B
	Right Turn	95	98	103.2%	8.2	2.5	A
	Subtotal	347	352	101.5%	13.9	2.2	B
WB	Left Turn	287	284	98.9%	13.8	1.7	B
	Through	324	323	99.7%	7.7	1.7	A
	Right Turn	47	47	100.2%	3.7	1.9	A
	Subtotal	658	654	99.4%	10.0	1.3	B
Total		1,352	1,354	100.1%	12.4	1.5	B

# MOVEMENT SUMMARY

 Site: 101 [Existing AM]

Deer Valley Drive / Marsac Avenue Roundabout  
 Site Category: (None)  
 Roundabout

Movement Performance - Vehicles												
Mov ID	Turn	Demand Total	Flows HV %	Deg. Satn v/c	Average Delay sec	Level of Service	95% Back of Queue Vehicles veh	Distance ft	Prop. Queued	Effective Stop Rate	Aver. No. Cycles	Average Speed mph
South: Marsac Avenue												
3	L2	1	100.0	0.157	13.4	LOS B	0.6	14.5	0.63	0.63	0.63	33.7
8	T1	127	3.0	0.157	7.8	LOS A	0.6	14.5	0.63	0.63	0.63	34.3
18b	R3	62	3.0	0.157	7.8	LOS A	0.6	14.5	0.63	0.63	0.63	32.5
Approach		189	3.5	0.157	7.9	LOS A	0.6	14.5	0.63	0.63	0.63	33.7
SouthEast: RoadName												
3bx	L3	32	3.0	0.142	4.3	LOS A	0.5	14.7	0.29	0.17	0.29	35.9
3ax	L1	19	100.0	0.142	7.1	LOS A	0.5	14.7	0.29	0.17	0.29	34.5
18ax	R1	269	3.0	0.142	4.3	LOS A	0.6	15.2	0.29	0.17	0.29	35.6
Approach		320	8.8	0.142	4.4	LOS A	0.6	15.2	0.29	0.17	0.29	35.5
North: Deer Valley Drive												
7u	U	23	3.0	0.748	14.3	LOS B	8.6	221.4	0.52	0.26	0.52	30.4
7a	L1	804	3.0	0.748	14.3	LOS B	8.6	221.4	0.52	0.26	0.52	29.5
4	T1	378	3.0	0.748	8.1	LOS A	8.6	221.4	0.32	0.15	0.32	33.5
14	R2	12	100.0	0.204	7.2	LOS A	0.9	23.5	0.20	0.09	0.20	34.5
Approach		1217	3.9	0.748	12.3	LOS B	8.6	221.4	0.45	0.23	0.45	30.7
West: Transit Center												
5	L2	2	100.0	0.159	18.6	LOS C	0.3	11.7	0.68	0.68	0.68	29.6
12a	R1	23	100.0	0.159	18.6	LOS C	0.3	11.7	0.68	0.68	0.68	29.2
12	R2	13	100.0	0.159	18.6	LOS C	0.3	11.7	0.68	0.68	0.68	28.6
Approach		38	100.0	0.159	18.6	LOS C	0.3	11.7	0.68	0.68	0.68	29.0
All Vehicles		1765	6.9	0.748	10.5	LOS B	8.6	221.4	0.45	0.27	0.45	31.7

Site Level of Service (LOS) Method: Delay & v/c (HCM 6). Site LOS Method is specified in the Parameter Settings dialog (Site tab).

Roundabout LOS Method: Same as Sign Control.

Vehicle movement LOS values are based on average delay and v/c ratio (degree of saturation) per movement.

LOS F will result if v/c > 1 irrespective of movement delay value (does not apply for approaches and intersection).

Intersection and Approach LOS values are based on average delay for all movements (v/c not used as specified in HCM 6).

Roundabout Capacity Model: US HCM 6.

HCM Delay Formula option is used. Control Delay does not include Geometric Delay since Exclude Geometric Delay option applies.

Gap-Acceptance Capacity: Traditional M1.

HV (%) values are calculated for All Movement Classes of All Heavy Vehicle Model Designation.

SimTraffic Post-Processor  
Average Results from 10 Runs  
Volume and Delay by Movement

Snow Park Village  
Existing  
PM Peak Hour

Intersection 3                      Deer Valley Drive East/Queen Esther Drive                      Side-street Stop

Direction	Movement	Demand Volume (vph)	Served Volume (vph)		Total Delay (sec/veh)		
			Average	Percent	Average	Std. Dev.	LOS
NB	Left Turn						
	Through	293	298	101.6%	1.0	0.3	A
	Right Turn	30	33	111.3%	0.8	0.6	A
	Subtotal	323	331	102.5%	1.0	0.3	A
SB	Left Turn	85	81	95.4%	4.6	0.7	A
	Through	78	78	99.9%	1.2	0.4	A
	Right Turn						
	Subtotal	163	159	97.5%	2.9	0.5	A
EB	Left Turn						
	Through						
	Right Turn						
	Subtotal						
WB	Left Turn	29	29	100.7%	8.5	4.0	A
	Through						
	Right Turn	60	60	100.7%	6.0	0.9	A
	Subtotal	89	90	100.7%	6.6	1.4	A
Total		575	580	100.8%	2.4	0.3	A

Intersection 4                      Solamere Drive/Deer Valley Drive East                      Side-street Stop

Direction	Movement	Demand Volume (vph)	Served Volume (vph)		Total Delay (sec/veh)		
			Average	Percent	Average	Std. Dev.	LOS
NB	Left Turn						
	Through						
	Right Turn						
	Subtotal						
SB	Left Turn	17	19	112.4%	10.6	4.9	B
	Through						
	Right Turn	80	87	108.6%	7.1	2.1	A
	Subtotal	97	106	109.3%	7.7	2.2	A
EB	Left Turn	87	84	96.4%	5.3	0.9	A
	Through	146	138	94.7%	1.9	0.8	A
	Right Turn						
	Subtotal	233	222	95.3%	3.3	0.9	A
WB	Left Turn						
	Through	319	324	101.6%	1.2	0.2	A
	Right Turn	34	35	102.1%	1.0	0.5	A
	Subtotal	353	359	101.6%	1.2	0.2	A
Total		683	687	100.6%	3.0	0.6	A

SimTraffic Post-Processor  
Average Results from 10 Runs  
Volume and Delay by Movement

Snow Park Village  
Existing  
PM Peak Hour

Intersection 5                      Deer Valley Drive West/Deer Valley Drive East                      Side-street Stop

Direction	Movement	Demand Volume (vph)	Served Volume (vph)		Total Delay (sec/veh)		
			Average	Percent	Average	Std. Dev.	LOS
NB	Left Turn						
	Through	536	536	100.0%	3.4	0.3	A
	Right Turn	44	45	102.3%	3.2	1.3	A
	Subtotal	580	581	100.2%	3.4	0.3	A
SB	Left Turn	189	178	94.2%	8.5	2.0	A
	Through	204	205	100.6%	2.0	0.5	A
	Right Turn						
	Subtotal	393	383	97.5%	5.0	1.2	A
EB	Left Turn						
	Through						
	Right Turn						
	Subtotal						
WB	Left Turn	22	25	113.6%	39.3	37.1	E
	Through						
	Right Turn	377	382	101.2%	31.9	17.5	D
	Subtotal	399	407	101.9%	32.3	18.3	D
Total		1,372	1,371	99.9%	12.2	5.4	B

Intersection 7                      Deer Valley Drive/Bonanza Drive                      Signal

Direction	Movement	Demand Volume (vph)	Served Volume (vph)		Total Delay (sec/veh)		
			Average	Percent	Average	Std. Dev.	LOS
NB	Left Turn						
	Through	754	744	98.6%	29.8	7.7	C
	Right Turn	651	660	101.4%	20.8	8.4	C
	Subtotal	1,405	1,404	99.9%	25.6	7.8	C
SB	Left Turn	251	205	81.6%	19.8	1.7	B
	Through	460	431	93.6%	7.8	1.0	A
	Right Turn						
	Subtotal	711	635	89.4%	11.5	1.5	B
EB	Left Turn						
	Through						
	Right Turn						
	Subtotal						
WB	Left Turn	419	415	99.0%	23.4	4.0	C
	Through						
	Right Turn	129	129	99.8%	13.3	8.1	B
	Subtotal	548	544	99.2%	20.8	5.1	C
Total		2,664	2,583	96.9%	21.2	5.2	C

SimTraffic Post-Processor  
Average Results from 10 Runs  
Volume and Delay by Movement

Snow Park Village  
Existing  
PM Peak Hour

Intersection 8 SR-224-Park Avenue/Empire Avenue-Deer Valley Drive Signal

Direction	Movement	Demand Volume (vph)	Served Volume (vph)		Total Delay (sec/veh)		LOS
			Average	Percent	Average	Std. Dev.	
NB	Left Turn	35	34	96.3%	26.9	5.4	C
	Through	395	387	98.1%	48.2	4.5	D
	Right Turn	68	74	108.1%	26.7	8.6	C
	Subtotal	498	495	99.3%	44.0	4.2	D
SB	Left Turn	495	389	78.7%	208.5	18.4	F
	Through	363	286	78.8%	164.0	18.2	F
	Right Turn	364	294	80.9%	44.7	5.1	D
	Subtotal	1,222	970	79.4%	147.7	13.7	F
EB	Left Turn	633	526	83.1%	87.2	7.4	F
	Through	277	240	86.5%	70.2	16.8	E
	Right Turn	36	30	83.6%	65.0	22.4	E
	Subtotal	946	796	84.1%	81.4	10.3	F
WB	Left Turn	75	74	98.9%	73.7	14.1	E
	Through	239	285	119.4%	56.1	8.1	E
	Right Turn	640	624	97.6%	40.2	5.9	D
	Subtotal	954	984	103.1%	47.7	3.3	D
Total		3,620	3,244	89.6%	84.3	3.4	F

Intersection 9 Monitor Drive-Bonanza Drive/SR-248 Signal

Direction	Movement	Demand Volume (vph)	Served Volume (vph)		Total Delay (sec/veh)		LOS
			Average	Percent	Average	Std. Dev.	
NB	Left Turn	176	166	94.4%	34.5	8.0	C
	Through	89	93	104.5%	29.9	6.0	C
	Right Turn	479	455	95.0%	11.2	2.4	B
	Subtotal	744	714	96.0%	19.4	2.8	B
SB	Left Turn	90	88	98.2%	30.0	5.6	C
	Through	55	50	91.5%	34.5	7.9	C
	Right Turn	63	59	92.9%	5.5	1.2	A
	Subtotal	208	197	94.8%	23.9	3.5	C
EB	Left Turn	71	68	96.3%	15.8	3.5	B
	Through	584	589	100.9%	26.4	3.4	C
	Right Turn	149	148	99.3%	21.2	4.8	C
	Subtotal	804	805	100.2%	24.6	3.1	C
WB	Left Turn	218	216	99.1%	17.7	3.0	B
	Through	384	386	100.5%	11.3	2.2	B
	Right Turn	46	49	106.3%	6.8	4.2	A
	Subtotal	648	651	100.4%	13.1	1.7	B
Total		2,404	2,367	98.5%	19.7	1.9	B



# MOVEMENT SUMMARY

 Site: 101 [Existing PM]

Deer Valley Drive / Marsac Avenue Roundabout  
 Site Category: (None)  
 Roundabout

Movement Performance - Vehicles												
Mov ID	Turn	Demand Total	Flows HV %	Deg. Satn v/c	Average Delay sec	Level of Service	95% Back of Queue Vehicles	Distance ft	Prop. Queued	Effective Stop Rate	Aver. No. Cycles	Average Speed mph
South: Marsac Avenue												
3	L2	1	100.0	0.344	13.5	LOS B	1.5	38.8	0.64	0.65	0.68	32.9
8	T1	454	3.0	0.344	9.0	LOS A	1.5	38.8	0.64	0.65	0.68	33.8
18b	R3	62	3.0	0.344	9.0	LOS A	1.5	38.8	0.64	0.65	0.68	32.1
Approach		516	3.2	0.344	9.0	LOS A	1.5	38.8	0.64	0.65	0.68	33.6
SouthEast: RoadName												
3bx	L3	36	3.0	0.559	14.3	LOS B	3.7	97.6	0.74	0.91	1.23	31.7
3ax	L1	13	100.0	0.559	19.1	LOS C	3.7	97.6	0.74	0.91	1.23	30.4
18ax	R1	732	3.0	0.559	14.2	LOS B	3.8	98.4	0.75	0.91	1.23	31.0
Approach		782	4.6	0.559	14.3	LOS B	3.8	98.4	0.75	0.91	1.23	31.0
North: Deer Valley Drive												
7u	U	242	3.0	0.617	10.2	LOS B	5.3	134.5	0.36	0.17	0.36	31.9
7a	L1	368	3.0	0.617	10.2	LOS B	5.3	134.5	0.36	0.17	0.36	31.0
4	T1	398	3.0	0.617	7.1	LOS A	5.3	134.5	0.27	0.12	0.27	33.7
14	R2	6	100.0	0.169	6.8	LOS A	0.7	18.8	0.18	0.08	0.18	34.6
Approach		1014	3.6	0.617	9.0	LOS A	5.3	134.5	0.32	0.15	0.32	32.2
West: Transit Center												
5	L2	5	100.0	0.078	14.1	LOS B	0.1	5.8	0.61	0.61	0.61	31.0
12a	R1	12	100.0	0.078	14.1	LOS B	0.1	5.8	0.61	0.61	0.61	30.5
12	R2	5	100.0	0.078	14.1	LOS B	0.1	5.8	0.61	0.61	0.61	29.9
Approach		22	100.0	0.078	14.1	LOS B	0.1	5.8	0.61	0.61	0.61	30.5
All Vehicles		2334	4.8	0.617	10.8	LOS B	5.3	134.5	0.54	0.52	0.71	32.1

Site Level of Service (LOS) Method: Delay & v/c (HCM 6). Site LOS Method is specified in the Parameter Settings dialog (Site tab).

Roundabout LOS Method: Same as Sign Control.

Vehicle movement LOS values are based on average delay and v/c ratio (degree of saturation) per movement.

LOS F will result if v/c > 1 irrespective of movement delay value (does not apply for approaches and intersection).

Intersection and Approach LOS values are based on average delay for all movements (v/c not used as specified in HCM 6).

Roundabout Capacity Model: US HCM 6.

HCM Delay Formula option is used. Control Delay does not include Geometric Delay since Exclude Geometric Delay option applies.

Gap-Acceptance Capacity: Traditional M1.

HV (%) values are calculated for All Movement Classes of All Heavy Vehicle Model Designation.

SimTraffic Post-Processor  
Average Results from 10 Runs  
Volume and Delay by Movement

Snow Park Village  
Existing Plus Project  
AM Peak Hour

**Intersection 1**                      **Deer Valley Drive East/Doe Pass Road**                      **Signal**

Direction	Movement	Demand Volume (vph)	Served Volume (vph)		Total Delay (sec/veh)		LOS
			Average	Percent	Average	Std. Dev.	
NB	Left Turn	90	88	97.6%	1.5	1.1	A
	Through						
	Right Turn						
	Subtotal						
SB	Left Turn	164	165	100.7%	1.5	0.7	A
	Through						
	Right Turn						
	Subtotal						
EB	Left Turn	31	31	99.0%	8.0	1.2	A
	Through						
	Right Turn						
	Subtotal						
WB	Left Turn						
	Through						
	Right Turn						
	Subtotal						
Total		300	298	99.4%	2.1	0.7	A

**Intersection 2**                      **Deer Valley Drive West/Doe Pass Road**                      **Side-street Stop**

Direction	Movement	Demand Volume (vph)	Served Volume (vph)		Total Delay (sec/veh)		LOS
			Average	Percent	Average	Std. Dev.	
NB	Left Turn	20	20	100.5%	9.7	3.5	A
	Through						
	Right Turn						
	Subtotal						
SB	Left Turn						
	Through						
	Right Turn						
	Subtotal						
EB	Left Turn	640	644	100.6%	3.7	0.4	A
	Through						
	Right Turn						
	Subtotal						
WB	Left Turn	142	143	100.6%	0.3	0.1	A
	Through						
	Right Turn						
	Subtotal						
Total		822	824	100.2%	3.3	0.4	A

SimTraffic Post-Processor  
Average Results from 10 Runs  
Volume and Delay by Movement

Snow Park Village  
Existing Plus Project  
AM Peak Hour

**Intersection 3**                      **Deer Valley Drive East/Queen Esther Drive**                      **Side-street Stop**

Direction	Movement	Demand Volume (vph)	Served Volume (vph)		Total Delay (sec/veh)		
			Average	Percent	Average	Std. Dev.	LOS
NB	Left Turn						
	Through	149	150	100.3%	0.8	0.2	A
	Right Turn	17	16	93.5%	1.1	0.7	A
	Subtotal	166	165	99.6%	0.8	0.2	A
SB	Left Turn	50	49	97.2%	4.3	0.4	A
	Through	173	173	99.9%	1.1	0.3	A
	Right Turn						
	Subtotal	223	222	99.3%	1.7	0.4	A
EB	Left Turn						
	Through						
	Right Turn						
	Subtotal						
WB	Left Turn	20	21	105.0%	6.9	2.0	A
	Through						
	Right Turn	55	57	103.1%	5.8	0.9	A
	Subtotal	75	78	103.6%	6.1	0.9	A
Total		464	465	100.1%	2.1	0.3	A

**Intersection 4**                      **Solamere Drive/Deer Valley Drive East**                      **Side-street Stop**

Direction	Movement	Demand Volume (vph)	Served Volume (vph)		Total Delay (sec/veh)		
			Average	Percent	Average	Std. Dev.	LOS
NB	Left Turn						
	Through						
	Right Turn						
	Subtotal						
SB	Left Turn	24	23	95.0%	7.3	1.6	A
	Through						
	Right Turn	57	60	105.6%	5.9	0.9	A
	Subtotal	81	83	102.5%	6.3	1.1	A
EB	Left Turn	49	45	91.6%	4.0	0.6	A
	Through	199	197	99.0%	1.5	0.5	A
	Right Turn						
	Subtotal	248	242	97.5%	2.0	0.4	A
WB	Left Turn						
	Through	185	187	100.9%	0.9	0.2	A
	Right Turn	19	19	100.0%	0.5	0.5	A
	Subtotal	204	206	100.8%	0.8	0.2	A
Total		533	531	99.5%	2.2	0.3	A

SimTraffic Post-Processor  
Average Results from 10 Runs  
Volume and Delay by Movement

Snow Park Village  
Existing Plus Project  
AM Peak Hour

**Intersection 5**                      **Deer Valley Drive West/Deer Valley Drive East**                      **Side-street Stop**

Direction	Movement	Demand Volume (vph)	Served Volume (vph)		Total Delay (sec/veh)		
			Average	Percent	Average	Std. Dev.	LOS
NB	Left Turn						
	Through	147	149	101.2%	1.0	0.3	A
	Right Turn	15	15	96.7%	0.6	1.0	A
	Subtotal	162	163	100.7%	1.0	0.3	A
SB	Left Turn	233	226	97.0%	5.8	0.6	A
	Through	653	651	99.8%	3.7	0.3	A
	Right Turn						
	Subtotal	886	877	99.0%	4.2	0.3	A
EB	Left Turn						
	Through						
	Right Turn						
	Subtotal						
WB	Left Turn	7	6	85.7%	16.7	13.8	C
	Through						
	Right Turn	235	238	101.4%	5.4	1.0	A
	Subtotal	242	244	100.9%	5.7	1.2	A
Total		1,290	1,285	99.6%	4.1	0.3	A

**Intersection 7**                      **Deer Valley Drive/Bonanza Drive**                      **Signal**

Direction	Movement	Demand Volume (vph)	Served Volume (vph)		Total Delay (sec/veh)		
			Average	Percent	Average	Std. Dev.	LOS
NB	Left Turn						
	Through	302	303	100.4%	13.2	2.9	B
	Right Turn	167	169	101.3%	2.8	0.7	A
	Subtotal	469	472	100.7%	9.5	2.1	A
SB	Left Turn	105	93	88.6%	13.2	2.3	B
	Through	673	644	95.7%	9.2	1.8	A
	Right Turn						
	Subtotal	778	737	94.7%	9.8	1.8	A
EB	Left Turn						
	Through						
	Right Turn						
	Subtotal						
WB	Left Turn	570	569	99.8%	15.8	1.7	B
	Through						
	Right Turn	198	192	97.2%	4.9	0.6	A
	Subtotal	768	761	99.1%	12.9	1.5	B
Total		2,015	1,971	97.8%	11.0	1.5	B

SimTraffic Post-Processor  
Average Results from 10 Runs  
Volume and Delay by Movement

Snow Park Village  
Existing Plus Project  
AM Peak Hour

**Intersection 8**                      **SR-224-Park Avenue/Empire Avenue-Deer Valley Drive**                      **Signal**

Direction	Movement	Demand Volume (vph)	Served Volume (vph)		Total Delay (sec/veh)		LOS
			Average	Percent	Average	Std. Dev.	
NB	Left Turn	36	37	103.3%	35.5	8.5	D
	Through	191	189	99.1%	52.9	5.9	D
	Right Turn	67	68	101.9%	17.6	9.5	B
	Subtotal	294	295	100.2%	42.0	4.7	D
SB	Left Turn	519	434	83.7%	211.5	15.3	F
	Through	169	142	84.0%	177.8	16.0	F
	Right Turn	901	773	85.8%	57.3	10.5	E
	Subtotal	1,589	1,349	84.9%	120.8	10.5	F
EB	Left Turn	320	319	99.7%	39.0	6.0	D
	Through	172	170	98.9%	30.1	8.8	C
	Right Turn	16	18	111.9%	23.3	15.1	C
	Subtotal	508	507	99.8%	35.2	6.4	D
WB	Left Turn	50	51	101.6%	65.8	13.5	E
	Through	253	280	110.6%	47.2	5.2	D
	Right Turn	254	249	98.1%	9.1	2.4	A
	Subtotal	557	580	104.1%	33.0	4.6	C
Total		2,948	2,731	92.6%	77.9	3.3	E

**Intersection 9**                      **Monitor Drive-Bonanza Drive/SR-248**                      **Signal**

Direction	Movement	Demand Volume (vph)	Served Volume (vph)		Total Delay (sec/veh)		LOS
			Average	Percent	Average	Std. Dev.	
NB	Left Turn	64	59	92.5%	20.6	3.0	C
	Through	28	29	102.9%	24.3	4.9	C
	Right Turn	117	111	94.7%	3.2	0.6	A
	Subtotal	209	199	95.1%	10.9	1.4	B
SB	Left Turn	54	53	97.4%	19.8	2.9	B
	Through	71	73	103.1%	22.9	4.2	C
	Right Turn	29	28	96.2%	4.2	1.0	A
	Subtotal	154	154	99.8%	18.2	1.7	B
EB	Left Turn	22	22	99.5%	12.0	3.8	B
	Through	230	233	101.4%	15.7	2.1	B
	Right Turn	95	99	103.8%	7.5	2.0	A
	Subtotal	347	354	102.0%	13.3	2.2	B
WB	Left Turn	304	296	97.2%	13.4	1.6	B
	Through	324	336	103.6%	8.1	1.2	A
	Right Turn	47	51	108.9%	3.8	1.4	A
	Subtotal	675	682	101.1%	10.2	1.0	B
Total		1,385	1,389	100.3%	12.0	0.9	B

# MOVEMENT SUMMARY

 Site: 101 [Existing Plus Project AM]

Deer Valley Drive / Marsac Avenue Roundabout  
 Site Category: (None)  
 Roundabout

Movement Performance - Vehicles												
Mov ID	Turn	Demand Total	Flows HV %	Deg. Satn v/c	Average Delay sec	Level of Service	95% Back of Queue Vehicles veh	Distance ft	Prop. Queued	Effective Stop Rate	Aver. No. Cycles	Average Speed mph
South: Marsac Avenue												
3	L2	1	100.0	0.178	14.8	LOS B	0.6	16.2	0.65	0.65	0.65	33.2
8	T1	127	3.0	0.178	8.7	LOS A	0.6	16.3	0.65	0.65	0.65	33.9
18b	R3	70	3.0	0.178	8.7	LOS A	0.6	16.3	0.65	0.65	0.65	32.1
Approach		198	3.5	0.178	8.7	LOS A	0.6	16.3	0.65	0.65	0.65	33.2
SouthEast: RoadName												
3bx	L3	40	3.0	0.179	4.6	LOS A	0.7	19.1	0.30	0.18	0.30	35.8
3ax	L1	23	100.0	0.179	7.5	LOS A	0.7	19.1	0.30	0.18	0.30	34.3
18ax	R1	340	3.0	0.179	4.6	LOS A	0.8	19.8	0.30	0.18	0.30	35.4
Approach		404	8.6	0.179	4.8	LOS A	0.8	19.8	0.30	0.18	0.30	35.4
North: Deer Valley Drive												
7u	U	23	3.0	0.806	17.4	LOS C	10.7	273.9	0.67	0.37	0.67	29.2
7a	L1	880	3.0	0.806	17.4	LOS C	10.7	273.9	0.67	0.37	0.67	28.4
4	T1	378	3.0	0.806	8.8	LOS A	10.7	273.9	0.37	0.20	0.37	33.2
14	R2	12	100.0	0.220	7.4	LOS A	1.0	25.6	0.23	0.11	0.23	34.3
Approach		1293	3.9	0.806	14.8	LOS B	10.7	273.9	0.58	0.32	0.58	29.7
West: Transit Center												
5	L2	2	100.0	0.191	20.8	LOS C	0.3	13.9	0.71	0.71	0.71	28.8
12a	R1	28	100.0	0.191	20.8	LOS C	0.3	13.9	0.71	0.71	0.71	28.4
12	R2	13	100.0	0.191	20.8	LOS C	0.3	13.9	0.71	0.71	0.71	27.8
Approach		43	100.0	0.191	20.8	LOS C	0.3	13.9	0.71	0.71	0.71	28.2
All Vehicles		1937	6.9	0.806	12.2	LOS B	10.7	273.9	0.53	0.33	0.53	31.0

Site Level of Service (LOS) Method: Delay & v/c (HCM 6). Site LOS Method is specified in the Parameter Settings dialog (Site tab).

Roundabout LOS Method: Same as Sign Control.

Vehicle movement LOS values are based on average delay and v/c ratio (degree of saturation) per movement.

LOS F will result if v/c > 1 irrespective of movement delay value (does not apply for approaches and intersection).

Intersection and Approach LOS values are based on average delay for all movements (v/c not used as specified in HCM 6).

Roundabout Capacity Model: US HCM 6.

HCM Delay Formula option is used. Control Delay does not include Geometric Delay since Exclude Geometric Delay option applies.

Gap-Acceptance Capacity: Traditional M1.

HV (%) values are calculated for All Movement Classes of All Heavy Vehicle Model Designation.



SimTraffic Post-Processor  
Average Results from 10 Runs  
Volume and Delay by Movement

Snow Park Village  
Existing Plus Project  
PM Peak Hour

**Intersection 1**                      **Deer Valley Drive East/Doe Pass Road**                      **Signal**

Direction	Movement	Demand Volume (vph)	Served Volume (vph)		Total Delay (sec/veh)		LOS
			Average	Percent	Average	Std. Dev.	
NB	Left Turn	363	357	98.5%	1.3	0.7	A
	Through						
	Right Turn						
	Subtotal						
SB	Left Turn	132	137	103.5%	1.3	0.3	A
	Through						
	Right Turn						
	Subtotal						
EB	Left Turn	26	25	96.9%	7.9	1.1	A
	Through						
	Right Turn						
	Subtotal						
WB	Left Turn						
	Through						
	Right Turn						
	Subtotal						
Total		536	534	99.6%	1.6	0.6	A

**Intersection 2**                      **Deer Valley Drive West/Doe Pass Road**                      **Side-street Stop**

Direction	Movement	Demand Volume (vph)	Served Volume (vph)		Total Delay (sec/veh)		LOS
			Average	Percent	Average	Std. Dev.	
NB	Left Turn	20	22	109.0%	12.4	3.1	B
	Through						
	Right Turn						
	Subtotal						
SB	Left Turn						
	Through						
	Right Turn						
	Subtotal						
EB	Left Turn	220	225	102.0%	1.4	0.3	A
	Through						
	Right Turn						
	Subtotal						
WB	Left Turn	560	566	101.1%	2.4	0.1	A
	Through						
	Right Turn						
	Subtotal						
Total		820	832	101.5%	2.4	0.2	A

SimTraffic Post-Processor  
Average Results from 10 Runs  
Volume and Delay by Movement

Snow Park Village  
Existing Plus Project  
PM Peak Hour

**Intersection 3**                      **Deer Valley Drive East/Queen Esther Drive**                      **Side-street Stop**

Direction	Movement	Demand Volume (vph)	Served Volume (vph)		Total Delay (sec/veh)		
			Average	Percent	Average	Std. Dev.	LOS
NB	Left Turn						
	Through	393	393	100.1%	1.2	0.3	A
	Right Turn	30	32	106.0%	1.3	0.7	A
	Subtotal	423	425	100.5%	1.2	0.3	A
SB	Left Turn	85	82	96.1%	4.9	0.4	A
	Through	168	177	105.6%	1.6	0.6	A
	Right Turn						
	Subtotal	253	259	102.4%	2.7	0.6	A
EB	Left Turn						
	Through						
	Right Turn						
	Subtotal						
WB	Left Turn	29	27	91.7%	8.3	1.8	A
	Through						
	Right Turn	60	65	108.3%	6.7	0.8	A
	Subtotal	89	92	102.9%	7.3	0.6	A
Total		765	776	101.4%	2.5	0.3	A

**Intersection 4**                      **Solamere Drive/Deer Valley Drive East**                      **Side-street Stop**

Direction	Movement	Demand Volume (vph)	Served Volume (vph)		Total Delay (sec/veh)		
			Average	Percent	Average	Std. Dev.	LOS
NB	Left Turn						
	Through						
	Right Turn						
	Subtotal						
SB	Left Turn	17	18	107.6%	13.1	5.2	B
	Through						
	Right Turn	80	80	99.4%	8.2	1.8	A
	Subtotal	97	98	100.8%	9.0	2.0	A
EB	Left Turn	87	79	90.7%	6.1	1.1	A
	Through	236	240	101.5%	2.1	0.8	A
	Right Turn						
	Subtotal	323	318	98.6%	3.0	0.8	A
WB	Left Turn						
	Through	419	422	100.8%	1.2	0.2	A
	Right Turn	34	35	102.4%	1.0	0.6	A
	Subtotal	453	457	100.9%	1.2	0.1	A
Total		873	873	100.0%	2.7	0.4	A

SimTraffic Post-Processor  
Average Results from 10 Runs  
Volume and Delay by Movement

Snow Park Village  
Existing Plus Project  
PM Peak Hour

**Intersection 5**                      **Deer Valley Drive West/Deer Valley Drive East**                      **Side-street Stop**

Direction	Movement	Demand Volume (vph)	Served Volume (vph)		Total Delay (sec/veh)		
			Average	Percent	Average	Std. Dev.	LOS
NB	Left Turn						
	Through	536	546	101.9%	2.7	0.3	A
	Right Turn	44	45	102.5%	1.9	0.8	A
	Subtotal	580	592	102.0%	2.7	0.3	A
SB	Left Turn	279	272	97.4%	9.4	2.3	A
	Through	218	221	101.3%	1.9	0.4	A
	Right Turn						
	Subtotal	497	493	99.1%	6.1	1.4	A
EB	Left Turn						
	Through						
	Right Turn						
	Subtotal						
WB	Left Turn	22	23	105.5%	78.8	35.7	F
	Through						
	Right Turn	477	465	97.4%	78.8	38.6	F
	Subtotal	499	488	97.8%	78.8	38.5	F
Total		1,576	1,572	99.7%	28.3	12.5	D

**Intersection 7**                      **Deer Valley Drive/Bonanza Drive**                      **Signal**

Direction	Movement	Demand Volume (vph)	Served Volume (vph)		Total Delay (sec/veh)		
			Average	Percent	Average	Std. Dev.	LOS
NB	Left Turn						
	Through	804	792	98.5%	35.4	16.9	D
	Right Turn	671	687	102.4%	29.5	22.9	C
	Subtotal	1,475	1,479	100.3%	32.7	19.6	C
SB	Left Turn	251	197	78.6%	19.0	2.2	B
	Through	512	433	84.6%	8.5	1.6	A
	Right Turn						
	Subtotal	763	630	82.6%	11.8	1.3	B
EB	Left Turn						
	Through						
	Right Turn						
	Subtotal						
WB	Left Turn	440	434	98.7%	26.2	7.2	C
	Through						
	Right Turn	129	132	102.6%	12.4	5.0	B
	Subtotal	569	567	99.6%	23.1	6.6	C
Total		2,807	2,676	95.3%	25.9	11.6	C

SimTraffic Post-Processor  
Average Results from 10 Runs  
Volume and Delay by Movement

Snow Park Village  
Existing Plus Project  
PM Peak Hour

**Intersection 8**                      **SR-224-Park Avenue/Empire Avenue-Deer Valley Drive**                      **Signal**

Direction	Movement	Demand Volume (vph)	Served Volume (vph)		Total Delay (sec/veh)		LOS
			Average	Percent	Average	Std. Dev.	
NB	Left Turn	35	34	96.3%	33.4	9.2	C
	Through	395	388	98.3%	50.2	6.5	D
	Right Turn	68	70	102.2%	30.1	7.8	C
	Subtotal	498	491	98.7%	46.1	5.6	D
SB	Left Turn	547	388	70.9%	219.3	16.6	F
	Through	363	259	71.3%	173.1	10.9	F
	Right Turn	364	251	69.1%	49.7	7.7	D
	Subtotal	1,274	898	70.5%	157.9	13.8	F
EB	Left Turn	633	529	83.5%	83.1	5.9	F
	Through	277	238	86.0%	60.9	11.1	E
	Right Turn	36	33	92.2%	63.7	15.2	E
	Subtotal	946	800	84.6%	75.5	7.4	E
WB	Left Turn	75	71	94.9%	67.7	13.3	E
	Through	239	293	122.5%	46.6	7.8	D
	Right Turn	690	659	95.5%	50.5	4.9	D
	Subtotal	1,004	1,023	101.9%	50.7	4.7	D
Total		3,722	3,213	86.3%	86.0	3.9	F

**Intersection 9**                      **Monitor Drive-Bonanza Drive/SR-248**                      **Signal**

Direction	Movement	Demand Volume (vph)	Served Volume (vph)		Total Delay (sec/veh)		LOS
			Average	Percent	Average	Std. Dev.	
NB	Left Turn	176	177	100.7%	32.0	4.1	C
	Through	89	95	107.0%	33.6	4.2	C
	Right Turn	499	469	93.9%	11.1	2.5	B
	Subtotal	764	741	97.0%	19.3	1.9	B
SB	Left Turn	90	92	101.9%	27.3	6.9	C
	Through	55	52	94.5%	35.4	4.5	D
	Right Turn	63	66	104.3%	5.2	1.1	A
	Subtotal	208	209	100.7%	22.7	3.4	C
EB	Left Turn	71	69	96.6%	13.6	2.9	B
	Through	584	592	101.4%	25.6	2.6	C
	Right Turn	149	150	100.9%	19.0	4.5	B
	Subtotal	804	811	100.8%	23.4	2.4	C
WB	Left Turn	239	232	97.0%	20.4	2.7	C
	Through	384	393	102.4%	12.3	2.4	B
	Right Turn	46	46	100.4%	7.0	2.9	A
	Subtotal	669	671	100.3%	14.8	1.6	B
Total		2,445	2,433	99.5%	19.7	1.4	B

# MOVEMENT SUMMARY

 Site: 101 [Existing Plus Project PM]

Deer Valley Drive / Marsac Avenue Roundabout  
 Site Category: (None)  
 Roundabout

Movement Performance - Vehicles												
Mov ID	Turn	Demand Total	Flows HV %	Deg. Satn v/c	Average Delay sec	Level of Service	95% Back of Queue Vehicles veh	Distance ft	Prop. Queued	Effective Stop Rate	Aver. No. Cycles	Average Speed mph
South: Marsac Avenue												
3	L2	1	100.0	0.385	15.4	LOS C	1.8	47.1	0.68	0.73	0.84	32.3
8	T1	454	3.0	0.385	10.4	LOS B	1.8	47.1	0.68	0.73	0.84	33.1
18b	R3	72	3.0	0.385	10.4	LOS B	1.8	47.1	0.68	0.73	0.84	31.5
Approach		526	3.2	0.385	10.4	LOS B	1.8	47.1	0.68	0.73	0.84	32.9
SouthEast: RoadName												
3bx	L3	46	3.0	0.634	16.9	LOS C	4.9	129.2	0.78	1.00	1.44	30.6
3ax	L1	18	100.0	0.634	21.7	LOS C	4.9	129.2	0.78	1.00	1.44	29.3
18ax	R1	818	3.0	0.634	16.7	LOS C	5.1	130.4	0.79	1.00	1.44	29.9
Approach		883	5.0	0.634	16.8	LOS C	5.1	130.4	0.79	1.00	1.44	30.0
North: Deer Valley Drive												
7u	U	242	3.0	0.684	12.1	LOS B	6.6	168.0	0.47	0.25	0.47	31.1
7a	L1	458	3.0	0.684	12.1	LOS B	6.6	168.0	0.47	0.25	0.47	30.2
4	T1	398	3.0	0.684	7.7	LOS A	6.6	168.0	0.33	0.17	0.33	33.4
14	R2	6	100.0	0.187	7.1	LOS A	0.8	21.1	0.22	0.10	0.22	34.4
Approach		1104	3.5	0.684	10.5	LOS B	6.6	168.0	0.42	0.22	0.42	31.5
West: Transit Center												
5	L2	5	100.0	0.105	15.9	LOS C	0.2	7.7	0.65	0.65	0.65	30.4
12a	R1	17	100.0	0.105	15.9	LOS C	0.2	7.7	0.65	0.65	0.65	29.9
12	R2	5	100.0	0.105	15.9	LOS C	0.2	7.7	0.65	0.65	0.65	29.3
Approach		27	100.0	0.105	15.9	LOS C	0.2	7.7	0.65	0.65	0.65	29.9
All Vehicles		2540	5.0	0.684	12.7	LOS B	6.6	168.0	0.60	0.60	0.86	31.2

Site Level of Service (LOS) Method: Delay & v/c (HCM 6). Site LOS Method is specified in the Parameter Settings dialog (Site tab).

Roundabout LOS Method: Same as Sign Control.

Vehicle movement LOS values are based on average delay and v/c ratio (degree of saturation) per movement.

LOS F will result if v/c > 1 irrespective of movement delay value (does not apply for approaches and intersection).

Intersection and Approach LOS values are based on average delay for all movements (v/c not used as specified in HCM 6).

Roundabout Capacity Model: US HCM 6.

HCM Delay Formula option is used. Control Delay does not include Geometric Delay since Exclude Geometric Delay option applies.

Gap-Acceptance Capacity: Traditional M1.

HV (%) values are calculated for All Movement Classes of All Heavy Vehicle Model Designation.

SIDRA INTERSECTION 8.0 | Copyright © 2000-2019 Akcelik and Associates Pty Ltd | sidrasolutions.com

Organisation: FEHR AND PEERS | Processed: Saturday, July 23, 2022 11:27:06 AM

Project: C:\Users\syamagata\Desktop\Projects\Snow Park Village\July 2022 TIS Update\SIDRA\DeerValleyDrRoundabout.sip8

SimTraffic Post-Processor  
Average Results from 10 Runs  
Volume and Delay by Movement

Snow Park Village  
Existing Plus Project - Mitigated  
AM Peak Hour

**Intersection 1**                      **Deer Valley Drive East/Doe Pass Road**                      **Signal**

Direction	Movement	Demand Volume (vph)	Served Volume (vph)		Total Delay (sec/veh)		LOS
			Average	Percent	Average	Std. Dev.	
NB	Left Turn	202	207	102.5%	1.0	0.9	A
	Through						
	Right Turn						
	Subtotal						
SB	Left Turn	329	330	100.3%	2.0	1.0	A
	Through						
	Right Turn						
	Subtotal						
EB	Left Turn	31	29	92.3%	8.5	1.3	A
	Through						
	Right Turn						
	Subtotal						
WB	Left Turn						
	Through						
	Right Turn						
	Subtotal						
Total		577	581	100.7%	1.9	1.0	A

**Intersection 2**                      **Deer Valley Drive West/Doe Pass Road**                      **Side-street Stop**

Direction	Movement	Demand Volume (vph)	Served Volume (vph)		Total Delay (sec/veh)		LOS
			Average	Percent	Average	Std. Dev.	
NB	Left Turn	20	19	94.0%	5.9	2.2	A
	Through						
	Right Turn						
	Subtotal						
SB	Left Turn						
	Through						
	Right Turn						
	Subtotal						
EB	Left Turn	475	477	100.3%	2.6	0.4	A
	Through						
	Right Turn						
	Subtotal						
WB	Left Turn	30	32	107.0%	0.2	0.1	A
	Through						
	Right Turn						
	Subtotal						
Total		545	546	100.2%	2.6	0.3	A



**Intersection 3**                      **Deer Valley Drive East/Queen Esther Drive**                      **Side-street Stop**

Direction	Movement	Demand Volume (vph)	Served Volume (vph)		Total Delay (sec/veh)		
			Average	Percent	Average	Std. Dev.	LOS
NB	Left Turn						
	Through	261	264	101.1%	1.0	0.2	A
	Right Turn	17	17	100.0%	0.7	0.3	A
	Subtotal	278	281	101.0%	0.9	0.2	A
SB	Left Turn	50	50	100.8%	4.7	0.5	A
	Through	338	343	101.5%	1.5	0.3	A
	Right Turn						
	Subtotal	388	393	101.4%	2.0	0.3	A
EB	Left Turn						
	Through						
	Right Turn						
	Subtotal						
WB	Left Turn	20	21	106.0%	9.5	2.6	A
	Through						
	Right Turn	55	59	107.5%	5.9	0.5	A
	Subtotal	75	80	107.1%	6.7	0.9	A
Total		741	755	101.8%	2.1	0.3	A

**Intersection 4**                      **Solamere Drive/Deer Valley Drive East**                      **Side-street Stop**

Direction	Movement	Demand Volume (vph)	Served Volume (vph)		Total Delay (sec/veh)		
			Average	Percent	Average	Std. Dev.	LOS
NB	Left Turn						
	Through						
	Right Turn						
	Subtotal						
SB	Left Turn	24	25	102.1%	11.7	3.6	B
	Through						
	Right Turn	57	60	104.9%	7.8	2.1	A
	Subtotal	81	84	104.1%	9.1	2.5	A
EB	Left Turn	49	50	102.2%	6.0	1.0	A
	Through	364	369	101.3%	2.6	0.7	A
	Right Turn						
	Subtotal	413	419	101.4%	3.1	0.7	A
WB	Left Turn						
	Through	297	302	101.6%	1.0	0.2	A
	Right Turn	19	20	103.7%	1.0	0.7	A
	Subtotal	316	321	101.7%	1.0	0.2	A
Total		810	825	101.8%	2.8	0.5	A

SimTraffic Post-Processor  
Average Results from 10 Runs  
Volume and Delay by Movement

Snow Park Village  
Existing Plus Project - Mitigated  
AM Peak Hour

**Intersection 5**                      **Deer Valley Drive West/Deer Valley Drive East**                      **Side-street Stop**

Direction	Movement	Demand Volume (vph)	Served Volume (vph)		Total Delay (sec/veh)		
			Average	Percent	Average	Std. Dev.	LOS
NB	Left Turn						
	Through	35	34	97.1%	8.3	2.2	A
	Right Turn	15	15	98.7%	6.6	2.6	A
	Subtotal	50	49	97.6%	8.0	2.1	A
SB	Left Turn	398	401	100.8%	1.5	0.2	A
	Through	488	486	99.6%	1.1	0.2	A
	Right Turn						
	Subtotal	886	887	100.1%	1.3	0.2	A
EB	Left Turn						
	Through						
	Right Turn						
	Subtotal						
WB	Left Turn	7	7	100.0%	12.8	11.6	B
	Through						
	Right Turn	347	352	101.5%	3.0	0.6	A
	Subtotal	354	359	101.5%	3.2	0.6	A
<b>Total</b>		<b>1,290</b>	<b>1,295</b>	<b>100.4%</b>	<b>2.1</b>	<b>0.3</b>	<b>A</b>

**Intersection 7**                      **Deer Valley Drive/Bonanza Drive**                      **Signal**

Direction	Movement	Demand Volume (vph)	Served Volume (vph)		Total Delay (sec/veh)		
			Average	Percent	Average	Std. Dev.	LOS
NB	Left Turn						
	Through	302	307	101.5%	13.5	1.0	B
	Right Turn	167	172	102.7%	3.5	0.4	A
	Subtotal	469	478	101.9%	10.0	0.9	A
SB	Left Turn	105	99	94.0%	12.8	2.5	B
	Through	673	642	95.4%	8.6	1.3	A
	Right Turn						
	Subtotal	778	741	95.2%	9.2	1.2	A
EB	Left Turn						
	Through						
	Right Turn						
	Subtotal						
WB	Left Turn	570	567	99.5%	16.4	1.8	B
	Through						
	Right Turn	198	196	98.8%	6.1	0.9	A
	Subtotal	768	763	99.3%	13.8	1.9	B
<b>Total</b>		<b>2,015</b>	<b>1,981</b>	<b>98.3%</b>	<b>11.1</b>	<b>1.0</b>	<b>B</b>

**Intersection 8 SR-224-Park Avenue/Empire Avenue-Deer Valley Drive Signal**

Direction	Movement	Demand Volume (vph)	Served Volume (vph)		Total Delay (sec/veh)		LOS
			Average	Percent	Average	Std. Dev.	
NB	Left Turn	36	37	102.5%	31.5	10.4	C
	Through	191	191	99.7%	50.8	8.0	D
	Right Turn	67	72	108.1%	15.5	7.2	B
	Subtotal	294	300	102.0%	40.2	7.0	D
SB	Left Turn	519	436	83.9%	208.9	16.6	F
	Through	169	145	86.0%	172.0	16.2	F
	Right Turn	901	746	82.7%	46.3	8.8	D
	Subtotal	1,589	1,326	83.5%	115.5	7.7	F
EB	Left Turn	320	317	99.1%	38.8	3.3	D
	Through	172	172	100.2%	27.1	7.5	C
	Right Turn	16	18	115.0%	24.8	16.1	C
	Subtotal	508	508	100.0%	34.5	4.0	C
WB	Left Turn	50	48	96.4%	61.6	11.3	E
	Through	253	288	113.7%	43.7	4.9	D
	Right Turn	254	256	100.8%	8.8	2.0	A
	Subtotal	557	592	106.2%	30.0	3.6	C
Total		2,948	2,726	92.5%	74.5	4.0	E

**Intersection 9 Monitor Drive-Bonanza Drive/SR-248 Signal**

Direction	Movement	Demand Volume (vph)	Served Volume (vph)		Total Delay (sec/veh)		LOS
			Average	Percent	Average	Std. Dev.	
NB	Left Turn	64	60	94.2%	23.3	5.8	C
	Through	28	32	113.2%	28.5	11.3	C
	Right Turn	117	116	98.8%	3.3	0.9	A
	Subtotal	209	208	99.3%	12.7	3.1	B
SB	Left Turn	54	52	96.9%	20.0	5.7	C
	Through	71	71	100.4%	25.1	3.1	C
	Right Turn	29	30	103.1%	4.5	1.0	A
	Subtotal	154	154	99.7%	19.7	2.7	B
EB	Left Turn	22	25	112.3%	11.4	3.7	B
	Through	230	233	101.3%	18.9	4.1	B
	Right Turn	95	100	104.7%	9.5	1.9	A
	Subtotal	347	357	102.9%	15.6	2.8	B
WB	Left Turn	304	293	96.4%	13.7	2.7	B
	Through	324	328	101.1%	8.3	1.6	A
	Right Turn	47	48	102.3%	5.6	1.9	A
	Subtotal	675	669	99.1%	10.6	1.9	B
Total		1,385	1,387	100.2%	13.2	1.8	B

SimTraffic Post-Processor  
Average Results from 10 Runs  
Volume and Delay by Movement

Snow Park Village  
Existing Plus Project - Mitigated  
PM Peak Hour

**Intersection 1**                      **Deer Valley Drive East/Doe Pass Road**                      **Signal**

Direction	Movement	Demand Volume (vph)	Served Volume (vph)		Total Delay (sec/veh)		LOS
			Average	Percent	Average	Std. Dev.	
NB	Left Turn	864	882	102.1%	2.9	1.2	A
	Through						
	Right Turn						
	Subtotal						
SB	Left Turn	132	133	100.9%	1.1	0.7	A
	Through						
	Right Turn						
	Subtotal						
EB	Left Turn	26	24	92.7%	8.4	1.9	A
	Through						
	Right Turn						
	Subtotal						
WB	Left Turn						
	Through						
	Right Turn						
	Subtotal						
Total		1,037	1,054	101.6%	2.7	1.1	A

**Intersection 2**                      **Deer Valley Drive West/Doe Pass Road**                      **Side-street Stop**

Direction	Movement	Demand Volume (vph)	Served Volume (vph)		Total Delay (sec/veh)		LOS
			Average	Percent	Average	Std. Dev.	
NB	Left Turn	20	19	95.5%	5.8	0.9	A
	Through						
	Right Turn						
	Subtotal						
SB	Left Turn						
	Through						
	Right Turn						
	Subtotal						
EB	Left Turn	220	223	101.4%	1.3	0.3	A
	Through						
	Right Turn						
	Subtotal						
WB	Left Turn	59	60	100.8%	1.6	0.3	A
	Through						
	Right Turn						
	Subtotal						
Total		319	321	100.7%	1.7	0.3	A

SimTraffic Post-Processor  
Average Results from 10 Runs  
Volume and Delay by Movement

Snow Park Village  
Existing Plus Project - Mitigated  
PM Peak Hour

**Intersection 3**                      **Deer Valley Drive East/Queen Esther Drive**                      **Side-street Stop**

Direction	Movement	Demand Volume (vph)	Served Volume (vph)		Total Delay (sec/veh)		
			Average	Percent	Average	Std. Dev.	LOS
NB	Left Turn						
	Through	894	921	103.0%	2.3	0.2	A
	Right Turn	30	32	107.0%	2.5	0.9	A
	Subtotal	924	953	103.1%	2.3	0.2	A
SB	Left Turn	85	81	94.8%	10.3	2.6	B
	Through	168	171	101.6%	3.6	1.4	A
	Right Turn						
	Subtotal	253	251	99.3%	5.6	1.6	A
EB	Left Turn						
	Through						
	Right Turn						
	Subtotal						
WB	Left Turn	29	28	94.8%	26.8	18.5	D
	Through						
	Right Turn	60	59	98.7%	18.3	7.2	C
	Subtotal	89	87	97.4%	21.8	10.4	C
Total		1,266	1,291	102.0%	4.2	1.2	A

**Intersection 4**                      **Solamere Drive/Deer Valley Drive East**                      **Side-street Stop**

Direction	Movement	Demand Volume (vph)	Served Volume (vph)		Total Delay (sec/veh)		
			Average	Percent	Average	Std. Dev.	LOS
NB	Left Turn						
	Through						
	Right Turn						
	Subtotal						
SB	Left Turn	17	17	100.6%	54.9	39.5	F
	Through						
	Right Turn	80	80	100.3%	38.4	32.8	E
	Subtotal	97	97	100.3%	41.5	33.2	E
EB	Left Turn	87	82	94.6%	15.2	3.7	C
	Through	236	234	99.2%	7.0	3.6	A
	Right Turn						
	Subtotal	323	316	97.9%	9.3	3.8	A
WB	Left Turn						
	Through	920	943	102.5%	2.3	0.2	A
	Right Turn	34	34	100.0%	1.7	0.6	A
	Subtotal	954	977	102.4%	2.2	0.2	A
Total		1,374	1,391	101.2%	6.8	3.8	A

SimTraffic Post-Processor  
Average Results from 10 Runs  
Volume and Delay by Movement

Snow Park Village  
Existing Plus Project - Mitigated  
PM Peak Hour

**Intersection 5**                      **Deer Valley Drive West/Deer Valley Drive East**                      **Side-street Stop**

Direction	Movement	Demand Volume (vph)	Served Volume (vph)		Total Delay (sec/veh)		
			Average	Percent	Average	Std. Dev.	LOS
NB	Left Turn						
	Through	35	35	100.6%	7.5	2.2	A
	Right Turn	44	44	99.8%	5.0	0.8	A
	Subtotal	79	79	100.1%	5.9	0.8	A
SB	Left Turn	279	270	96.7%	0.8	0.2	A
	Through	218	217	99.7%	0.6	0.1	A
	Right Turn						
	Subtotal	497	487	98.0%	0.7	0.1	A
EB	Left Turn						
	Through						
	Right Turn						
	Subtotal						
WB	Left Turn	22	24	110.0%	16.8	5.6	C
	Through						
	Right Turn	978	994	101.6%	12.8	2.5	B
	Subtotal	1,000	1,018	101.8%	12.9	2.5	B
Total		1,576	1,584	100.5%	8.7	1.7	A

**Intersection 7**                      **Deer Valley Drive/Bonanza Drive**                      **Signal**

Direction	Movement	Demand Volume (vph)	Served Volume (vph)		Total Delay (sec/veh)		
			Average	Percent	Average	Std. Dev.	LOS
NB	Left Turn						
	Through	804	799	99.3%	44.3	29.8	D
	Right Turn	671	680	101.4%	35.8	34.1	D
	Subtotal	1,475	1,479	100.3%	40.3	31.7	D
SB	Left Turn	251	202	80.6%	20.5	5.9	C
	Through	512	448	87.5%	7.6	1.1	A
	Right Turn						
	Subtotal	763	651	85.3%	11.5	2.4	B
EB	Left Turn						
	Through						
	Right Turn						
	Subtotal						
WB	Left Turn	440	446	101.3%	27.8	6.1	C
	Through						
	Right Turn	129	130	100.8%	13.0	5.1	B
	Subtotal	569	576	101.1%	24.6	5.9	C
Total		2,807	2,705	96.4%	29.6	18.1	C



**Intersection 8**                      **SR-224-Park Avenue/Empire Avenue-Deer Valley Drive**                      **Signal**

Direction	Movement	Demand Volume (vph)	Served Volume (vph)		Total Delay (sec/veh)		LOS
			Average	Percent	Average	Std. Dev.	
NB	Left Turn	35	36	101.7%	32.3	12.8	C
	Through	395	396	100.2%	47.1	4.6	D
	Right Turn	68	72	105.4%	32.5	4.4	C
	Subtotal	498	503	101.0%	43.9	4.5	D
SB	Left Turn	547	386	70.6%	217.7	18.3	F
	Through	363	262	72.1%	169.7	14.7	F
	Right Turn	364	266	73.0%	53.4	8.9	D
	Subtotal	1,274	914	71.7%	155.3	14.9	F
EB	Left Turn	633	537	84.8%	83.4	6.7	F
	Through	277	244	88.2%	60.6	4.8	E
	Right Turn	36	31	87.2%	52.6	16.3	D
	Subtotal	946	812	85.9%	75.4	4.4	E
WB	Left Turn	75	68	90.3%	76.9	20.3	E
	Through	239	282	117.9%	57.3	13.6	E
	Right Turn	690	647	93.7%	51.1	5.0	D
	Subtotal	1,004	996	99.2%	54.5	5.8	D
Total		3,722	3,225	86.7%	86.8	4.6	F

**Intersection 9**                      **Monitor Drive-Bonanza Drive/SR-248**                      **Signal**

Direction	Movement	Demand Volume (vph)	Served Volume (vph)		Total Delay (sec/veh)		LOS
			Average	Percent	Average	Std. Dev.	
NB	Left Turn	176	166	94.4%	36.6	8.8	D
	Through	89	93	104.7%	31.2	4.2	C
	Right Turn	499	469	93.9%	13.6	3.0	B
	Subtotal	764	728	95.3%	21.0	3.2	C
SB	Left Turn	90	90	100.4%	31.9	7.1	C
	Through	55	53	95.8%	41.9	10.5	D
	Right Turn	63	62	98.4%	5.4	1.2	A
	Subtotal	208	205	98.6%	25.7	3.6	C
EB	Left Turn	71	72	100.8%	15.9	3.3	B
	Through	584	586	100.3%	26.2	3.2	C
	Right Turn	149	148	99.5%	20.6	4.6	C
	Subtotal	804	806	100.2%	24.3	2.8	C
WB	Left Turn	239	237	99.1%	20.2	3.4	C
	Through	384	390	101.6%	11.5	1.7	B
	Right Turn	46	51	110.9%	7.7	2.5	A
	Subtotal	669	678	101.3%	14.2	1.8	B
Total		2,445	2,417	98.9%	20.6	2.0	C

SimTraffic Post-Processor  
Average Results from 10 Runs  
Volume and Delay by Movement

Snow Park Village  
Opening Year Background  
AM Peak Hour

Intersection 3                      Deer Valley Drive East/Queen Esther Drive                      Side-street Stop

Direction	Movement	Demand Volume (vph)	Served Volume (vph)		Total Delay (sec/veh)		
			Average	Percent	Average	Std. Dev.	LOS
NB	Left Turn						
	Through	75	75	99.6%	0.2	0.2	A
	Right Turn	20	18	90.0%	0.5	1.0	A
	Subtotal	95	93	97.6%	0.2	0.3	A
SB	Left Turn	50	50	99.8%	4.0	0.4	A
	Through	120	126	105.3%	1.0	0.2	A
	Right Turn						
	Subtotal	170	176	103.7%	1.9	0.3	A
EB	Left Turn						
	Through						
	Right Turn						
	Subtotal						
WB	Left Turn	20	22	111.0%	5.9	1.1	A
	Through						
	Right Turn	55	55	100.2%	5.1	0.3	A
	Subtotal	75	77	103.1%	5.3	0.5	A
Total		340	346	101.9%	2.2	0.2	A

Intersection 4                      Solamere Drive/Deer Valley Drive East                      Side-street Stop

Direction	Movement	Demand Volume (vph)	Served Volume (vph)		Total Delay (sec/veh)		
			Average	Percent	Average	Std. Dev.	LOS
NB	Left Turn						
	Through						
	Right Turn						
	Subtotal						
SB	Left Turn	25	24	94.8%	6.2	1.6	A
	Through						
	Right Turn	60	62	104.0%	5.8	0.8	A
	Subtotal	85	86	101.3%	5.9	0.9	A
EB	Left Turn	50	51	101.0%	4.3	0.6	A
	Through	145	153	105.4%	1.5	0.5	A
	Right Turn						
	Subtotal	195	203	104.3%	2.3	0.5	A
WB	Left Turn						
	Through	110	109	99.2%	1.0	0.3	A
	Right Turn	20	21	104.0%	0.8	0.6	A
	Subtotal	130	130	99.9%	1.0	0.2	A
Total		410	419	102.3%	2.6	0.4	A

SimTraffic Post-Processor  
Average Results from 10 Runs  
Volume and Delay by Movement

Snow Park Village  
Opening Year Background  
AM Peak Hour

Intersection 5                      Deer Valley Drive West/Deer Valley Drive East                      Side-street Stop

Direction	Movement	Demand Volume (vph)	Served Volume (vph)		Total Delay (sec/veh)		
			Average	Percent	Average	Std. Dev.	LOS
NB	Left Turn						
	Through	150	151	100.9%	1.2	0.3	A
	Right Turn	15	15	101.3%	0.7	0.8	A
	Subtotal	165	167	100.9%	1.2	0.3	A
SB	Left Turn	180	186	103.6%	5.7	0.5	A
	Through	635	636	100.2%	3.6	0.4	A
	Right Turn						
	Subtotal	815	823	100.9%	4.1	0.2	A
EB	Left Turn						
	Through						
	Right Turn						
	Subtotal						
WB	Left Turn	10	9	90.0%	14.2	10.1	B
	Through						
	Right Turn	160	162	101.2%	4.5	0.6	A
	Subtotal	170	171	100.5%	5.0	1.0	A
Total		1,150	1,160	100.9%	3.8	0.2	A

Intersection 7                      Deer Valley Drive/Bonanza Drive                      Signal

Direction	Movement	Demand Volume (vph)	Served Volume (vph)		Total Delay (sec/veh)		
			Average	Percent	Average	Std. Dev.	LOS
NB	Left Turn						
	Through	265	263	99.3%	12.8	2.3	B
	Right Turn	165	170	102.7%	2.7	0.9	A
	Subtotal	430	433	100.6%	9.1	1.6	A
SB	Left Turn	115	102	89.0%	11.7	2.9	B
	Through	635	620	97.6%	9.7	1.8	A
	Right Turn						
	Subtotal	750	722	96.3%	10.0	1.9	B
EB	Left Turn						
	Through						
	Right Turn						
	Subtotal						
WB	Left Turn	585	591	101.0%	15.6	0.8	B
	Through						
	Right Turn	215	222	103.4%	5.4	1.3	A
	Subtotal	800	813	101.6%	12.8	0.9	B
Total		1,980	1,968	99.4%	11.0	1.1	B

SimTraffic Post-Processor  
Average Results from 10 Runs  
Volume and Delay by Movement

Snow Park Village  
Opening Year Background  
AM Peak Hour

**Intersection 8**                      **SR-224-Park Avenue/Empire Avenue-Deer Valley Drive**                      **Signal**

Direction	Movement	Demand Volume (vph)	Served Volume (vph)		Total Delay (sec/veh)		LOS
			Average	Percent	Average	Std. Dev.	
NB	Left Turn	55	51	93.5%	34.8	3.8	C
	Through	195	198	101.3%	51.8	5.3	D
	Right Turn	75	73	96.9%	19.4	5.8	B
	Subtotal	325	322	99.0%	41.9	4.6	D
SB	Left Turn	475	404	85.1%	212.0	13.3	F
	Through	170	146	85.7%	173.4	18.6	F
	Right Turn	1,065	917	86.1%	72.5	16.1	E
	Subtotal	1,710	1,467	85.8%	121.5	7.1	F
EB	Left Turn	385	392	101.7%	44.4	7.5	D
	Through	240	238	99.0%	28.5	5.7	C
	Right Turn	25	28	111.6%	28.3	14.5	C
	Subtotal	650	657	101.1%	38.2	7.0	D
WB	Left Turn	50	48	96.2%	75.9	14.9	E
	Through	325	355	109.3%	68.7	15.7	E
	Right Turn	215	218	101.2%	10.0	1.9	B
	Subtotal	590	621	105.2%	49.4	9.8	D
<b>Total</b>		<b>3,275</b>	<b>3,067</b>	<b>93.6%</b>	<b>81.9</b>	<b>6.0</b>	<b>F</b>

**Intersection 9**                      **Monitor Drive-Bonanza Drive/SR-248**                      **Signal**

Direction	Movement	Demand Volume (vph)	Served Volume (vph)		Total Delay (sec/veh)		LOS
			Average	Percent	Average	Std. Dev.	
NB	Left Turn	65	58	89.4%	22.8	5.7	C
	Through	30	30	99.0%	23.4	6.9	C
	Right Turn	110	106	96.5%	3.1	0.7	A
	Subtotal	205	194	94.6%	12.2	2.4	B
SB	Left Turn	60	56	93.2%	18.4	7.3	B
	Through	75	75	99.9%	25.4	4.2	C
	Right Turn	30	31	103.0%	4.8	1.0	A
	Subtotal	165	162	98.0%	18.9	3.0	B
EB	Left Turn	25	24	95.6%	14.8	1.9	B
	Through	250	247	98.9%	18.6	2.4	B
	Right Turn	100	99	98.6%	8.5	2.4	A
	Subtotal	375	370	98.6%	15.8	2.2	B
WB	Left Turn	305	309	101.3%	14.0	2.3	B
	Through	350	344	98.4%	8.6	1.3	A
	Right Turn	50	49	98.8%	4.8	2.0	A
	Subtotal	705	703	99.7%	10.7	1.3	B
<b>Total</b>		<b>1,450</b>	<b>1,428</b>	<b>98.5%</b>	<b>13.1</b>	<b>1.2</b>	<b>B</b>

# MOVEMENT SUMMARY

 Site: 101 [2024 BG AM]

Deer Valley Drive / Marsac Avenue Roundabout  
 Site Category: (None)  
 Roundabout

Movement Performance - Vehicles												
Mov ID	Turn	Demand Total	Flows HV %	Deg. Satn v/c	Average Delay sec	Level of Service	95% Back Vehicles veh	of Queue Distance ft	Prop. Queued	Effective Stop Rate	Aver. No. Cycles	Average Speed mph
South: Marsac Avenue												
3	L2	5	100.0	0.174	14.0	LOS B	0.6	15.9	0.63	0.63	0.63	33.7
8	T1	133	3.0	0.174	8.2	LOS A	0.6	16.1	0.63	0.63	0.63	33.9
18b	R3	64	3.0	0.174	8.2	LOS A	0.6	16.1	0.64	0.64	0.64	32.4
Approach		202	5.6	0.174	8.4	LOS A	0.6	16.1	0.63	0.63	0.63	33.4
SouthEast: RoadName												
3bx	L3	32	3.0	0.150	4.5	LOS A	0.5	15.5	0.32	0.19	0.32	35.8
3ax	L1	21	100.0	0.150	7.4	LOS A	0.5	15.5	0.32	0.19	0.32	34.4
18ax	R1	277	3.0	0.150	4.4	LOS A	0.6	16.1	0.32	0.20	0.32	35.5
Approach		330	9.3	0.150	4.6	LOS A	0.6	16.1	0.32	0.20	0.32	35.4
North: Deer Valley Drive												
7u	U	27	3.0	0.769	15.4	LOS C	9.2	236.0	0.59	0.32	0.59	30.0
7a	L1	809	3.0	0.769	15.4	LOS C	9.2	236.0	0.59	0.32	0.59	29.1
4	T1	383	3.0	0.769	8.7	LOS A	9.2	236.0	0.36	0.19	0.36	33.1
14	R2	16	100.0	0.210	7.3	LOS A	0.9	24.1	0.22	0.11	0.22	34.4
Approach		1234	4.3	0.769	13.2	LOS B	9.2	236.0	0.51	0.27	0.51	30.3
West: Transit Center												
5	L2	5	100.0	0.201	19.9	LOS C	0.3	14.9	0.69	0.69	0.69	28.9
12a	R1	27	100.0	0.201	19.9	LOS C	0.3	14.9	0.69	0.69	0.69	28.6
12	R2	16	100.0	0.201	19.9	LOS C	0.3	14.9	0.69	0.69	0.69	28.0
Approach		48	100.0	0.201	19.9	LOS C	0.3	14.9	0.69	0.69	0.69	28.4
All Vehicles		1814	7.8	0.769	11.3	LOS B	9.2	236.0	0.50	0.31	0.50	31.4

Site Level of Service (LOS) Method: Delay & v/c (HCM 6). Site LOS Method is specified in the Parameter Settings dialog (Site tab).

Roundabout LOS Method: Same as Sign Control.

Vehicle movement LOS values are based on average delay and v/c ratio (degree of saturation) per movement.

LOS F will result if v/c > 1 irrespective of movement delay value (does not apply for approaches and intersection).

Intersection and Approach LOS values are based on average delay for all movements (v/c not used as specified in HCM 6).

Roundabout Capacity Model: US HCM 6.

HCM Delay Formula option is used. Control Delay does not include Geometric Delay since Exclude Geometric Delay option applies.

Gap-Acceptance Capacity: Traditional M1.

HV (%) values are calculated for All Movement Classes of All Heavy Vehicle Model Designation.

SIDRA INTERSECTION 8.0 | Copyright © 2000-2019 Akcelik and Associates Pty Ltd | sidrasolutions.com

Organisation: FEHR AND PEERS | Processed: Thursday, July 21, 2022 9:44:32 AM

Project: C:\Users\syamagata\Desktop\Projects\Snow Park Village\July 2022 TIS Update\SIDRA\DeerValleyDrRoundabout.sip8

SimTraffic Post-Processor  
Average Results from 10 Runs  
Volume and Delay by Movement

Snow Park Village  
Opening Year Background  
PM Peak Hour

Intersection 3                      Deer Valley Drive East/Queen Esther Drive                      Side-street Stop

Direction	Movement	Demand Volume (vph)	Served Volume (vph)		Total Delay (sec/veh)		
			Average	Percent	Average	Std. Dev.	LOS
NB	Left Turn						
	Through	305	317	103.8%	1.0	0.2	A
	Right Turn	30	32	108.0%	0.9	0.7	A
	Subtotal	335	349	104.1%	1.0	0.2	A
SB	Left Turn	85	86	100.8%	5.1	0.7	A
	Through	85	84	99.3%	1.8	0.9	A
	Right Turn						
	Subtotal	170	170	100.1%	3.3	0.7	A
EB	Left Turn						
	Through						
	Right Turn						
	Subtotal						
WB	Left Turn	30	25	83.7%	8.2	2.8	A
	Through						
	Right Turn	60	61	102.3%	5.8	0.5	A
	Subtotal	90	87	96.1%	6.5	0.9	A
Total		595	606	101.8%	2.4	0.3	A

Intersection 4                      Solamere Drive/Deer Valley Drive East                      Side-street Stop

Direction	Movement	Demand Volume (vph)	Served Volume (vph)		Total Delay (sec/veh)		
			Average	Percent	Average	Std. Dev.	LOS
NB	Left Turn						
	Through						
	Right Turn						
	Subtotal						
SB	Left Turn	20	19	93.0%	11.2	4.5	B
	Through						
	Right Turn	80	80	99.9%	6.5	0.7	A
	Subtotal	100	99	98.5%	7.3	1.1	A
EB	Left Turn	90	89	99.1%	5.8	1.1	A
	Through	150	149	99.3%	1.8	0.6	A
	Right Turn						
	Subtotal	240	238	99.3%	3.3	0.8	A
WB	Left Turn						
	Through	330	339	102.6%	1.1	0.1	A
	Right Turn	35	38	108.6%	1.4	0.5	A
	Subtotal	365	377	103.2%	1.1	0.1	A
Total		705	713	101.2%	2.7	0.3	A



SimTraffic Post-Processor  
Average Results from 10 Runs  
Volume and Delay by Movement

Snow Park Village  
Opening Year Background  
PM Peak Hour

Intersection 5                      Deer Valley Drive West/Deer Valley Drive East                      Side-street Stop

Direction	Movement	Demand Volume (vph)	Served Volume (vph)		Total Delay (sec/veh)		
			Average	Percent	Average	Std. Dev.	LOS
NB	Left Turn						
	Through	545	547	100.3%	3.6	0.4	A
	Right Turn	45	45	100.9%	1.8	0.7	A
	Subtotal	590	592	100.3%	3.5	0.3	A
SB	Left Turn	195	191	98.1%	8.7	2.1	A
	Through	210	209	99.6%	1.7	0.4	A
	Right Turn						
	Subtotal	405	401	98.9%	5.1	1.3	A
EB	Left Turn						
	Through						
	Right Turn						
	Subtotal						
WB	Left Turn	25	27	108.0%	41.3	27.9	E
	Through						
	Right Turn	385	390	101.3%	36.6	16.7	E
	Subtotal	410	417	101.7%	36.7	16.9	E
Total		1,405	1,410	100.3%	13.6	5.5	B

Intersection 7                      Deer Valley Drive/Bonanza Drive                      Signal

Direction	Movement	Demand Volume (vph)	Served Volume (vph)		Total Delay (sec/veh)		
			Average	Percent	Average	Std. Dev.	LOS
NB	Left Turn						
	Through	755	743	98.4%	27.5	2.6	C
	Right Turn	690	696	100.9%	17.7	1.5	B
	Subtotal	1,445	1,440	99.6%	22.9	1.9	C
SB	Left Turn	275	204	74.3%	20.6	3.6	C
	Through	460	376	81.8%	7.6	1.8	A
	Right Turn						
	Subtotal	735	581	79.0%	12.2	1.6	B
EB	Left Turn						
	Through						
	Right Turn						
	Subtotal						
WB	Left Turn	445	444	99.7%	25.4	4.0	C
	Through						
	Right Turn	145	148	101.7%	10.0	2.0	A
	Subtotal	590	591	100.2%	21.6	3.2	C
Total		2,770	2,611	94.3%	20.1	1.3	C

SimTraffic Post-Processor  
Average Results from 10 Runs  
Volume and Delay by Movement

Snow Park Village  
Opening Year Background  
PM Peak Hour

Intersection 8 SR-224-Park Avenue/Empire Avenue-Deer Valley Drive Signal

Direction	Movement	Demand Volume (vph)	Served Volume (vph)		Total Delay (sec/veh)		
			Average	Percent	Average	Std. Dev.	LOS
NB	Left Turn	35	34	97.1%	33.2	6.1	C
	Through	395	399	101.0%	50.8	4.0	D
	Right Turn	70	77	110.6%	29.5	7.9	C
	Subtotal	500	510	102.0%	46.6	3.9	D
SB	Left Turn	495	370	74.7%	223.0	17.6	F
	Through	365	274	75.2%	174.9	13.5	F
	Right Turn	445	334	75.0%	47.8	7.2	D
	Subtotal	1,305	978	75.0%	151.2	13.7	F
EB	Left Turn	765	500	65.3%	84.9	4.7	F
	Through	355	231	65.1%	62.3	12.7	E
	Right Turn	50	37	73.6%	54.3	17.3	D
	Subtotal	1,170	768	65.6%	77.0	6.3	E
WB	Left Turn	80	76	94.8%	81.2	17.1	F
	Through	310	357	115.0%	63.5	15.9	E
	Right Turn	640	630	98.4%	37.7	7.7	D
	Subtotal	1,030	1,062	103.1%	49.3	9.0	D
Total		4,005	3,318	82.8%	84.7	2.6	F

Intersection 9 Monitor Drive-Bonanza Drive/SR-248 Signal

Direction	Movement	Demand Volume (vph)	Served Volume (vph)		Total Delay (sec/veh)		
			Average	Percent	Average	Std. Dev.	LOS
NB	Left Turn	180	175	97.0%	32.9	5.9	C
	Through	90	93	103.3%	31.5	5.6	C
	Right Turn	505	468	92.6%	12.2	2.4	B
	Subtotal	775	735	94.9%	19.7	2.1	B
SB	Left Turn	100	99	99.4%	34.1	6.9	C
	Through	55	58	105.6%	39.6	4.9	D
	Right Turn	65	66	101.5%	6.1	1.7	A
	Subtotal	220	224	101.6%	28.0	3.2	C
EB	Left Turn	75	76	101.2%	16.2	3.3	B
	Through	635	642	101.0%	25.9	2.6	C
	Right Turn	150	147	97.9%	20.9	3.6	C
	Subtotal	860	864	100.5%	24.3	2.2	C
WB	Left Turn	230	223	97.0%	19.6	3.8	B
	Through	420	430	102.4%	11.5	2.2	B
	Right Turn	50	51	102.8%	8.4	3.4	A
	Subtotal	700	705	100.7%	13.8	1.9	B
Total		2,555	2,528	98.9%	20.4	1.5	C

# MOVEMENT SUMMARY

 Site: 101 [2024 BG PM]

Deer Valley Drive / Marsac Avenue Roundabout  
 Site Category: (None)  
 Roundabout

Movement Performance - Vehicles												
Mov ID	Turn	Demand Total	Flows HV %	Deg. Satn v/c	Average Delay sec	Level of Service	95% Back of Queue Vehicles veh	Distance ft	Prop. Queued	Effective Stop Rate	Aver. No. Cycles	Average Speed mph
South: Marsac Avenue												
3	L2	1	100.0	0.356	13.9	LOS B	1.6	41.4	0.65	0.67	0.73	32.8
8	T1	460	3.0	0.356	9.3	LOS A	1.6	41.5	0.65	0.67	0.73	33.6
18b	R3	66	3.0	0.356	9.3	LOS A	1.6	41.5	0.65	0.67	0.73	32.0
Approach		526	3.2	0.356	9.3	LOS A	1.6	41.5	0.65	0.67	0.73	33.4
SouthEast: RoadName												
3bx	L3	40	3.0	0.582	15.1	LOS C	4.0	106.0	0.75	0.94	1.29	31.4
3ax	L1	15	100.0	0.582	19.9	LOS C	4.0	106.0	0.75	0.94	1.29	30.0
18ax	R1	753	3.0	0.582	15.0	LOS B	4.2	107.0	0.76	0.94	1.29	30.7
Approach		808	4.8	0.582	15.1	LOS C	4.2	107.0	0.76	0.94	1.29	30.7
North: Deer Valley Drive												
7u	U	242	3.0	0.636	10.7	LOS B	5.6	143.3	0.40	0.20	0.40	31.7
7a	L1	379	3.0	0.636	10.7	LOS B	5.6	143.3	0.40	0.20	0.40	30.8
4	T1	404	3.0	0.636	7.5	LOS A	5.6	143.3	0.30	0.14	0.30	33.4
14	R2	10	100.0	0.174	6.9	LOS A	0.7	19.3	0.20	0.09	0.20	34.6
Approach		1035	3.9	0.636	9.4	LOS A	5.6	143.3	0.35	0.17	0.35	32.0
West: Transit Center												
5	L2	5	100.0	0.090	14.6	LOS B	0.1	6.7	0.62	0.62	0.62	30.9
12a	R1	15	100.0	0.090	14.6	LOS B	0.1	6.7	0.62	0.62	0.62	30.4
12	R2	5	100.0	0.090	14.6	LOS B	0.1	6.7	0.62	0.62	0.62	29.8
Approach		25	100.0	0.090	14.6	LOS B	0.1	6.7	0.62	0.62	0.62	30.4
All Vehicles		2395	5.1	0.636	11.4	LOS B	5.6	143.3	0.56	0.55	0.75	31.8

Site Level of Service (LOS) Method: Delay & v/c (HCM 6). Site LOS Method is specified in the Parameter Settings dialog (Site tab).

Roundabout LOS Method: Same as Sign Control.

Vehicle movement LOS values are based on average delay and v/c ratio (degree of saturation) per movement.

LOS F will result if v/c > 1 irrespective of movement delay value (does not apply for approaches and intersection).

Intersection and Approach LOS values are based on average delay for all movements (v/c not used as specified in HCM 6).

Roundabout Capacity Model: US HCM 6.

HCM Delay Formula option is used. Control Delay does not include Geometric Delay since Exclude Geometric Delay option applies.

Gap-Acceptance Capacity: Traditional M1.

HV (%) values are calculated for All Movement Classes of All Heavy Vehicle Model Designation.

SIDRA INTERSECTION 8.0 | Copyright © 2000-2019 Akcelik and Associates Pty Ltd | sidrasolutions.com

Organisation: FEHR AND PEERS | Processed: Thursday, July 21, 2022 9:46:48 AM

Project: C:\Users\syamagata\Desktop\Projects\Snow Park Village\July 2022 TIS Update\SIDRA\DeerValleyDrRoundabout.sip8

SimTraffic Post-Processor  
Average Results from 10 Runs  
Volume and Delay by Movement

Snow Park Village  
Opening Year Plus Project  
AM Peak Hour

**Intersection 1**                      **Deer Valley Drive East/Doe Pass Road**                      **Signal**

Direction	Movement	Demand Volume (vph)	Served Volume (vph)		Total Delay (sec/veh)		LOS
			Average	Percent	Average	Std. Dev.	
NB	Left Turn	98	100	101.6%	1.0	0.9	A
	Through						
	Right Turn						
	Subtotal						
SB	Left Turn	168	168	100.1%	1.4	0.5	A
	Through						
	Right Turn						
	Subtotal						
EB	Left Turn	31	29	92.9%	7.3	0.8	A
	Through						
	Right Turn						
	Subtotal						
WB	Left Turn						
	Through						
	Right Turn						
	Subtotal						
Total		312	310	99.3%	1.8	0.7	A

**Intersection 2**                      **Deer Valley Drive West/Doe Pass Road**                      **Side-street Stop**

Direction	Movement	Demand Volume (vph)	Served Volume (vph)		Total Delay (sec/veh)		LOS
			Average	Percent	Average	Std. Dev.	
NB	Left Turn	20	20	99.5%	10.0	4.2	B
	Through						
	Right Turn						
	Subtotal						
SB	Left Turn						
	Through						
	Right Turn						
	Subtotal						
EB	Left Turn	651	653	100.4%	3.2	0.3	A
	Through						
	Right Turn						
	Subtotal						
WB	Left Turn	145	146	100.8%	1.8	0.5	A
	Through						
	Right Turn						
	Subtotal						
Total		836	840	100.5%	3.2	0.2	A

SimTraffic Post-Processor  
Average Results from 10 Runs  
Volume and Delay by Movement

Snow Park Village  
Opening Year Plus Project  
AM Peak Hour

**Intersection 3**                      **Deer Valley Drive East/Queen Esther Drive**                      **Side-street Stop**

Direction	Movement	Demand Volume (vph)	Served Volume (vph)		Total Delay (sec/veh)		
			Average	Percent	Average	Std. Dev.	LOS
NB	Left Turn						
	Through	154	155	100.6%	0.4	0.2	A
	Right Turn	20	20	99.0%	0.5	0.7	A
	Subtotal	174	175	100.4%	0.4	0.2	A
SB	Left Turn	50	51	101.6%	4.2	0.5	A
	Through	177	176	99.5%	1.2	0.3	A
	Right Turn						
	Subtotal	227	227	100.0%	1.9	0.3	A
EB	Left Turn						
	Through						
	Right Turn						
	Subtotal						
WB	Left Turn	20	21	104.0%	7.1	3.5	A
	Through						
	Right Turn	55	55	99.5%	5.7	0.9	A
	Subtotal	75	76	100.7%	6.3	1.0	A
Total		476	477	100.2%	2.0	0.4	A

**Intersection 4**                      **Solamere Drive/Deer Valley Drive East**                      **Side-street Stop**

Direction	Movement	Demand Volume (vph)	Served Volume (vph)		Total Delay (sec/veh)		
			Average	Percent	Average	Std. Dev.	LOS
NB	Left Turn						
	Through						
	Right Turn						
	Subtotal						
SB	Left Turn	25	27	106.0%	7.9	2.1	A
	Through						
	Right Turn	60	62	103.0%	5.4	0.3	A
	Subtotal	85	88	103.9%	6.2	0.8	A
EB	Left Turn	50	49	98.8%	4.2	1.1	A
	Through	202	199	98.4%	1.5	0.4	A
	Right Turn						
	Subtotal	252	248	98.5%	2.0	0.6	A
WB	Left Turn						
	Through	189	186	98.4%	0.9	0.1	A
	Right Turn	20	21	104.0%	0.8	0.6	A
	Subtotal	209	207	98.9%	0.9	0.1	A
Total		546	543	99.5%	2.3	0.4	A

SimTraffic Post-Processor  
Average Results from 10 Runs  
Volume and Delay by Movement

Snow Park Village  
Opening Year Plus Project  
AM Peak Hour

**Intersection 5**                      **Deer Valley Drive West/Deer Valley Drive East**                      **Side-street Stop**

Direction	Movement	Demand Volume (vph)	Served Volume (vph)		Total Delay (sec/veh)		
			Average	Percent	Average	Std. Dev.	LOS
NB	Left Turn						
	Through	150	152	101.1%	1.2	0.4	A
	Right Turn	15	15	98.7%	0.6	0.7	A
	Subtotal	165	167	100.9%	1.1	0.3	A
SB	Left Turn	237	233	98.1%	6.0	0.7	A
	Through	661	661	100.1%	3.7	0.2	A
	Right Turn						
	Subtotal	898	894	99.5%	4.3	0.3	A
EB	Left Turn						
	Through						
	Right Turn						
	Subtotal						
WB	Left Turn	10	10	98.0%	13.4	11.0	B
	Through						
	Right Turn	239	236	98.6%	5.1	0.4	A
	Subtotal	249	245	98.6%	5.6	0.7	A
<b>Total</b>		<b>1,312</b>	<b>1,306</b>	<b>99.5%</b>	<b>4.1</b>	<b>0.3</b>	<b>A</b>

**Intersection 7**                      **Deer Valley Drive/Bonanza Drive**                      **Signal**

Direction	Movement	Demand Volume (vph)	Served Volume (vph)		Total Delay (sec/veh)		
			Average	Percent	Average	Std. Dev.	LOS
NB	Left Turn						
	Through	304	305	100.4%	14.0	1.8	B
	Right Turn	181	176	97.2%	3.2	0.7	A
	Subtotal	485	481	99.2%	10.2	1.3	B
SB	Left Turn	115	100	86.9%	13.5	3.6	B
	Through	677	641	94.7%	9.4	1.8	A
	Right Turn						
	Subtotal	792	741	93.5%	9.9	1.8	A
EB	Left Turn						
	Through						
	Right Turn						
	Subtotal						
WB	Left Turn	602	604	100.4%	17.1	2.9	B
	Through						
	Right Turn	215	212	98.4%	6.2	1.5	A
	Subtotal	817	816	99.9%	14.2	2.7	B
<b>Total</b>		<b>2,094</b>	<b>2,038</b>	<b>97.3%</b>	<b>11.7</b>	<b>1.7</b>	<b>B</b>



SimTraffic Post-Processor  
Average Results from 10 Runs  
Volume and Delay by Movement

Snow Park Village  
Opening Year Plus Project  
AM Peak Hour

**Intersection 8**                      **SR-224-Park Avenue/Empire Avenue-Deer Valley Drive**                      **Signal**

Direction	Movement	Demand Volume (vph)	Served Volume (vph)		Total Delay (sec/veh)		LOS
			Average	Percent	Average	Std. Dev.	
NB	Left Turn	55	58	104.5%	29.4	9.7	C
	Through	195	199	102.0%	51.1	5.7	D
	Right Turn	75	75	99.7%	18.5	5.4	B
	Subtotal	325	331	101.9%	39.7	5.7	D
SB	Left Turn	517	414	80.0%	214.0	13.8	F
	Through	170	135	79.6%	182.7	10.5	F
	Right Turn	1,065	859	80.6%	64.2	14.8	E
	Subtotal	1,752	1,408	80.4%	121.5	10.6	F
EB	Left Turn	385	369	95.9%	42.2	8.6	D
	Through	240	230	95.8%	27.8	12.6	C
	Right Turn	25	25	101.2%	23.3	30.1	C
	Subtotal	650	624	96.0%	36.1	9.9	D
WB	Left Turn	50	45	90.4%	82.7	18.0	F
	Through	325	354	108.9%	59.7	15.8	E
	Right Turn	254	252	99.0%	11.5	1.6	B
	Subtotal	629	651	103.4%	42.3	10.3	D
<b>Total</b>		<b>3,356</b>	<b>3,014</b>	<b>89.8%</b>	<b>78.5</b>	<b>5.3</b>	<b>E</b>

**Intersection 9**                      **Monitor Drive-Bonanza Drive/SR-248**                      **Signal**

Direction	Movement	Demand Volume (vph)	Served Volume (vph)		Total Delay (sec/veh)		LOS
			Average	Percent	Average	Std. Dev.	
NB	Left Turn	65	55	84.3%	22.5	4.9	C
	Through	30	27	91.3%	30.1	7.4	C
	Right Turn	126	124	98.7%	3.1	0.6	A
	Subtotal	221	207	93.4%	11.5	3.2	B
SB	Left Turn	60	58	96.3%	19.3	3.5	B
	Through	75	71	94.7%	24.7	4.7	C
	Right Turn	30	32	107.3%	5.1	0.8	A
	Subtotal	165	161	97.6%	18.8	3.2	B
EB	Left Turn	25	25	101.6%	10.1	2.9	B
	Through	250	248	99.0%	17.8	3.2	B
	Right Turn	100	99	99.1%	9.3	3.4	A
	Subtotal	375	372	99.2%	15.2	3.0	B
WB	Left Turn	322	320	99.4%	13.8	1.2	B
	Through	350	339	96.7%	8.2	1.6	A
	Right Turn	50	53	106.4%	4.6	1.4	A
	Subtotal	722	712	98.6%	10.5	1.0	B
<b>Total</b>		<b>1,483</b>	<b>1,451</b>	<b>97.9%</b>	<b>12.7</b>	<b>1.4</b>	<b>B</b>

# MOVEMENT SUMMARY

 Site: 101 [2024 Plus Project AM]

Deer Valley Drive / Marsac Avenue Roundabout  
 Site Category: (None)  
 Roundabout

Movement Performance - Vehicles												
Mov ID	Turn	Demand Total	Flows HV %	Deg. Satn v/c	Average Delay sec	Level of Service	95% Back of Queue Vehicles veh	Distance ft	Prop. Queued	Effective Stop Rate	Aver. No. Cycles	Average Speed mph
South: Marsac Avenue												
3	L2	5	100.0	0.196	15.4	LOS C	0.7	17.8	0.65	0.65	0.65	33.2
8	T1	133	3.0	0.196	9.2	LOS A	0.7	18.0	0.65	0.65	0.65	33.5
18b	R3	72	3.0	0.196	9.1	LOS A	0.7	18.0	0.66	0.66	0.66	31.9
Approach		211	5.4	0.196	9.3	LOS A	0.7	18.0	0.66	0.66	0.66	32.9
SouthEast: RoadName												
3bx	L3	40	3.0	0.188	4.8	LOS A	0.7	20.1	0.33	0.20	0.33	35.6
3ax	L1	26	100.0	0.188	7.7	LOS A	0.7	20.1	0.33	0.20	0.33	34.2
18ax	R1	348	3.0	0.188	4.8	LOS A	0.8	20.8	0.33	0.21	0.33	35.3
Approach		414	9.0	0.188	5.0	LOS A	0.8	20.8	0.33	0.21	0.33	35.2
North: Deer Valley Drive												
7u	U	27	3.0	0.829	19.0	LOS C	11.5	293.3	0.76	0.44	0.76	28.6
7a	L1	884	3.0	0.829	19.0	LOS C	11.5	293.3	0.76	0.44	0.76	27.8
4	T1	383	3.0	0.829	9.7	LOS A	11.5	293.3	0.42	0.23	0.42	32.8
14	R2	16	100.0	0.227	7.6	LOS A	1.0	26.3	0.25	0.13	0.25	34.3
Approach		1310	4.2	0.829	16.1	LOS C	11.5	293.3	0.65	0.38	0.65	29.2
West: Transit Center												
5	L2	5	100.0	0.236	22.5	LOS C	0.4	17.5	0.72	0.72	0.73	28.1
12a	R1	31	100.0	0.236	22.5	LOS C	0.4	17.5	0.72	0.72	0.73	27.7
12	R2	16	100.0	0.236	22.5	LOS C	0.4	17.5	0.72	0.72	0.73	27.2
Approach		52	100.0	0.236	22.5	LOS C	0.4	17.5	0.72	0.72	0.73	27.6
All Vehicles		1986	7.8	0.829	13.3	LOS B	11.5	293.3	0.59	0.38	0.59	30.6

Site Level of Service (LOS) Method: Delay & v/c (HCM 6). Site LOS Method is specified in the Parameter Settings dialog (Site tab).

Roundabout LOS Method: Same as Sign Control.

Vehicle movement LOS values are based on average delay and v/c ratio (degree of saturation) per movement.

LOS F will result if v/c > 1 irrespective of movement delay value (does not apply for approaches and intersection).

Intersection and Approach LOS values are based on average delay for all movements (v/c not used as specified in HCM 6).

Roundabout Capacity Model: US HCM 6.

HCM Delay Formula option is used. Control Delay does not include Geometric Delay since Exclude Geometric Delay option applies.

Gap-Acceptance Capacity: Traditional M1.

HV (%) values are calculated for All Movement Classes of All Heavy Vehicle Model Designation.

SimTraffic Post-Processor  
Average Results from 10 Runs  
Volume and Delay by Movement

Snow Park Village  
Opening Year Plus Project  
PM Peak Hour

**Intersection 1**                      **Deer Valley Drive East/Doe Pass Road**                      **Signal**

Direction	Movement	Demand Volume (vph)	Served Volume (vph)		Total Delay (sec/veh)		LOS
			Average	Percent	Average	Std. Dev.	
NB	Left Turn	375	369	98.4%	1.3	0.5	A
	Through						
	Right Turn						
	Subtotal	375	369	98.4%	1.3	0.5	A
SB	Left Turn	140	138	98.3%	1.1	0.7	A
	Through						
	Right Turn						
	Subtotal	155	153	98.6%	1.1	0.7	A
EB	Left Turn	26	24	91.9%	8.2	1.6	A
	Through						
	Right Turn						
	Subtotal	26	24	91.9%	8.2	1.6	A
WB	Left Turn						
	Through						
	Right Turn						
	Subtotal						
<b>Total</b>		<b>556</b>	<b>546</b>	<b>98.2%</b>	<b>1.6</b>	<b>0.5</b>	<b>A</b>

**Intersection 2**                      **Deer Valley Drive West/Doe Pass Road**                      **Side-street Stop**

Direction	Movement	Demand Volume (vph)	Served Volume (vph)		Total Delay (sec/veh)		LOS
			Average	Percent	Average	Std. Dev.	
NB	Left Turn	20	19	95.5%	14.5	5.7	B
	Through						
	Right Turn						
	Subtotal	20	19	95.5%	14.5	5.7	B
SB	Left Turn						
	Through						
	Right Turn						
	Subtotal						
EB	Left Turn	229	227	99.3%	1.6	0.4	A
	Through						
	Right Turn						
	Subtotal	249	246	98.8%	1.5	0.4	A
WB	Left Turn	570	568	99.6%	2.4	0.1	A
	Through						
	Right Turn						
	Subtotal	570	568	99.6%	2.4	0.1	A
<b>Total</b>		<b>839</b>	<b>833</b>	<b>99.2%</b>	<b>2.5</b>	<b>0.2</b>	<b>A</b>

SimTraffic Post-Processor  
Average Results from 10 Runs  
Volume and Delay by Movement

Snow Park Village  
Opening Year Plus Project  
PM Peak Hour

**Intersection 3**                      **Deer Valley Drive East/Queen Esther Drive**                      **Side-street Stop**

Direction	Movement	Demand Volume (vph)	Served Volume (vph)		Total Delay (sec/veh)		
			Average	Percent	Average	Std. Dev.	LOS
NB	Left Turn						
	Through	405	398	98.2%	1.2	0.2	A
	Right Turn	30	35	116.3%	1.1	0.7	A
	Subtotal	435	433	99.5%	1.2	0.2	A
SB	Left Turn	85	84	99.3%	5.4	0.5	A
	Through	175	180	102.6%	1.9	0.5	A
	Right Turn						
	Subtotal	260	264	101.5%	3.0	0.5	A
EB	Left Turn						
	Through						
	Right Turn						
	Subtotal						
WB	Left Turn	30	29	96.0%	10.0	3.5	A
	Through						
	Right Turn	60	59	99.0%	7.2	1.5	A
	Subtotal	90	88	98.0%	8.2	2.0	A
Total		785	785	100.0%	2.6	0.4	A

**Intersection 4**                      **Solamere Drive/Deer Valley Drive East**                      **Side-street Stop**

Direction	Movement	Demand Volume (vph)	Served Volume (vph)		Total Delay (sec/veh)		
			Average	Percent	Average	Std. Dev.	LOS
NB	Left Turn						
	Through						
	Right Turn						
	Subtotal						
SB	Left Turn	20	20	98.0%	11.8	4.9	B
	Through						
	Right Turn	80	82	102.6%	8.2	1.7	A
	Subtotal	100	102	101.7%	8.9	1.6	A
EB	Left Turn	90	90	99.9%	6.7	1.6	A
	Through	240	242	100.7%	2.7	0.6	A
	Right Turn						
	Subtotal	330	332	100.5%	3.7	0.8	A
WB	Left Turn						
	Through	430	421	97.9%	1.2	0.2	A
	Right Turn	35	34	96.6%	1.0	0.3	A
	Subtotal	465	455	97.8%	1.2	0.2	A
Total		895	888	99.2%	3.0	0.6	A

SimTraffic Post-Processor  
Average Results from 10 Runs  
Volume and Delay by Movement

Snow Park Village  
Opening Year Plus Project  
PM Peak Hour

**Intersection 5**                      **Deer Valley Drive West/Deer Valley Drive East**                      **Side-street Stop**

Direction	Movement	Demand Volume (vph)	Served Volume (vph)		Total Delay (sec/veh)		
			Average	Percent	Average	Std. Dev.	LOS
NB	Left Turn						
	Through	545	540	99.0%	2.5	0.4	A
	Right Turn	45	47	104.9%	1.6	0.8	A
	Subtotal	590	587	99.4%	2.5	0.4	A
SB	Left Turn	285	283	99.3%	8.5	1.2	A
	Through	224	223	99.6%	1.9	0.5	A
	Right Turn						
	Subtotal	509	506	99.4%	5.6	1.2	A
EB	Left Turn						
	Through						
	Right Turn						
	Subtotal						
WB	Left Turn	25	22	88.4%	70.1	29.9	F
	Through						
	Right Turn	485	475	97.8%	73.8	26.4	F
	Subtotal	510	497	97.4%	73.7	26.4	F
Total		1,609	1,590	98.8%	26.4	8.3	D

**Intersection 7**                      **Deer Valley Drive/Bonanza Drive**                      **Signal**

Direction	Movement	Demand Volume (vph)	Served Volume (vph)		Total Delay (sec/veh)		
			Average	Percent	Average	Std. Dev.	LOS
NB	Left Turn						
	Through	805	798	99.1%	32.8	6.7	C
	Right Turn	710	708	99.7%	25.2	6.5	C
	Subtotal	1,515	1,506	99.4%	29.3	6.2	C
SB	Left Turn	275	201	73.0%	19.9	3.8	B
	Through	512	415	81.1%	7.8	1.0	A
	Right Turn						
	Subtotal	787	616	78.2%	11.9	1.3	B
EB	Left Turn						
	Through						
	Right Turn						
	Subtotal						
WB	Left Turn	466	461	98.9%	26.2	4.0	C
	Through						
	Right Turn	145	150	103.7%	13.6	3.3	B
	Subtotal	611	611	100.0%	23.2	3.5	C
Total		2,913	2,733	93.8%	24.0	3.7	C

SimTraffic Post-Processor  
Average Results from 10 Runs  
Volume and Delay by Movement

Snow Park Village  
Opening Year Plus Project  
PM Peak Hour

**Intersection 8**                      **SR-224-Park Avenue/Empire Avenue-Deer Valley Drive**                      **Signal**

Direction	Movement	Demand Volume (vph)	Served Volume (vph)		Total Delay (sec/veh)		LOS
			Average	Percent	Average	Std. Dev.	
NB	Left Turn	35	35	99.4%	30.4	6.5	C
	Through	395	392	99.2%	55.8	4.1	E
	Right Turn	70	74	105.1%	34.2	10.3	C
	Subtotal	500	500	100.1%	50.9	4.8	D
SB	Left Turn	547	378	69.2%	234.7	15.2	F
	Through	365	237	65.0%	183.4	14.0	F
	Right Turn	445	301	67.5%	53.1	7.5	D
	Subtotal	1,357	916	67.5%	162.2	8.0	F
EB	Left Turn	765	516	67.4%	86.1	3.5	F
	Through	355	244	68.6%	56.4	7.9	E
	Right Turn	50	34	67.0%	42.7	9.9	D
	Subtotal	1,170	793	67.7%	75.3	4.1	E
WB	Left Turn	80	77	96.0%	87.3	25.5	F
	Through	310	356	114.8%	59.4	14.6	E
	Right Turn	690	654	94.8%	47.8	7.1	D
	Subtotal	1,080	1,087	100.6%	55.2	7.2	E
<b>Total</b>		<b>4,107</b>	<b>3,296</b>	<b>80.2%</b>	<b>87.8</b>	<b>2.3</b>	<b>F</b>

**Intersection 9**                      **Monitor Drive-Bonanza Drive/SR-248**                      **Signal**

Direction	Movement	Demand Volume (vph)	Served Volume (vph)		Total Delay (sec/veh)		LOS
			Average	Percent	Average	Std. Dev.	
NB	Left Turn	180	175	97.1%	40.9	7.6	D
	Through	90	92	101.9%	31.0	6.1	C
	Right Turn	525	471	89.8%	13.0	2.5	B
	Subtotal	795	738	92.8%	22.1	2.1	C
SB	Left Turn	100	94	94.4%	34.6	9.2	C
	Through	55	55	99.6%	42.8	7.3	D
	Right Turn	65	69	106.0%	5.9	1.2	A
	Subtotal	220	218	99.1%	27.8	4.6	C
EB	Left Turn	75	74	98.7%	14.5	2.2	B
	Through	635	645	101.5%	26.7	1.8	C
	Right Turn	150	145	96.9%	21.3	2.1	C
	Subtotal	860	864	100.5%	24.7	1.6	C
WB	Left Turn	251	250	99.5%	21.1	2.3	C
	Through	420	419	99.7%	11.3	2.6	B
	Right Turn	50	51	101.2%	6.4	2.1	A
	Subtotal	721	719	99.7%	14.3	1.5	B
<b>Total</b>		<b>2,596</b>	<b>2,539</b>	<b>97.8%</b>	<b>21.3</b>	<b>1.1</b>	<b>C</b>



# MOVEMENT SUMMARY

 Site: 101 [2024 Plus Project PM]

Deer Valley Drive / Marsac Avenue Roundabout  
 Site Category: (None)  
 Roundabout

Movement Performance - Vehicles												
Mov ID	Turn	Demand Total	Flows HV %	Deg. Satn v/c	Average Delay sec	Level of Service	95% Back of Queue Vehicles veh	Distance ft	Prop. Queued	Effective Stop Rate	Aver. No. Cycles	Average Speed mph
South: Marsac Avenue												
3	L2	1	100.0	0.398	15.9	LOS C	1.9	49.8	0.69	0.75	0.88	32.1
8	T1	460	3.0	0.398	10.8	LOS B	1.9	49.9	0.69	0.75	0.88	32.9
18b	R3	76	3.0	0.398	10.8	LOS B	1.9	49.9	0.69	0.75	0.88	31.3
Approach		536	3.2	0.398	10.8	LOS B	1.9	49.9	0.69	0.75	0.88	32.7
SouthEast: RoadName												
3bx	L3	51	3.0	0.657	18.0	LOS C	5.3	140.5	0.79	1.04	1.53	30.1
3ax	L1	20	100.0	0.657	22.8	LOS C	5.3	140.5	0.79	1.04	1.53	28.9
18ax	R1	838	3.0	0.657	17.8	LOS C	5.5	141.8	0.80	1.04	1.52	29.5
Approach		909	5.2	0.657	17.9	LOS C	5.5	141.8	0.80	1.04	1.52	29.5
North: Deer Valley Drive												
7u	U	242	3.0	0.704	12.8	LOS B	7.0	179.3	0.52	0.29	0.52	30.8
7a	L1	469	3.0	0.704	12.8	LOS B	7.0	179.3	0.52	0.29	0.52	29.9
4	T1	404	3.0	0.704	8.2	LOS A	7.0	179.3	0.36	0.19	0.36	33.2
14	R2	10	100.0	0.193	7.2	LOS A	0.8	21.7	0.23	0.11	0.23	34.5
Approach		1125	3.9	0.704	11.1	LOS B	7.0	179.3	0.46	0.25	0.46	31.2
West: Transit Center												
5	L2	5	100.0	0.118	16.5	LOS C	0.2	8.7	0.65	0.65	0.65	30.2
12a	R1	20	100.0	0.118	16.5	LOS C	0.2	8.7	0.65	0.65	0.65	29.7
12	R2	5	100.0	0.118	16.5	LOS C	0.2	8.7	0.65	0.65	0.65	29.1
Approach		30	100.0	0.118	16.5	LOS C	0.2	8.7	0.65	0.65	0.65	29.7
All Vehicles		2601	5.3	0.704	13.5	LOS B	7.0	179.3	0.63	0.63	0.92	30.9

Site Level of Service (LOS) Method: Delay & v/c (HCM 6). Site LOS Method is specified in the Parameter Settings dialog (Site tab).

Roundabout LOS Method: Same as Sign Control.

Vehicle movement LOS values are based on average delay and v/c ratio (degree of saturation) per movement.

LOS F will result if v/c > 1 irrespective of movement delay value (does not apply for approaches and intersection).

Intersection and Approach LOS values are based on average delay for all movements (v/c not used as specified in HCM 6).

Roundabout Capacity Model: US HCM 6.

HCM Delay Formula option is used. Control Delay does not include Geometric Delay since Exclude Geometric Delay option applies.

Gap-Acceptance Capacity: Traditional M1.

HV (%) values are calculated for All Movement Classes of All Heavy Vehicle Model Designation.

**SIDRA INTERSECTION 8.0 | Copyright © 2000-2019 Akcelik and Associates Pty Ltd | sidrasolutions.com**

Organisation: FEHR AND PEERS | Processed: Saturday, July 23, 2022 11:29:21 AM

Project: C:\Users\syamagata\Desktop\Projects\Snow Park Village\July 2022 TIS Update\SIDRA\DeerValleyDrRoundabout.sip8

**Intersection 1**                      **Deer Valley Drive East/Doe Pass Road**                      **Signal**

Direction	Movement	Demand Volume (vph)	Served Volume (vph)		Total Delay (sec/veh)		LOS
			Average	Percent	Average	Std. Dev.	
NB	Left Turn	213	211	98.9%	1.3	0.4	A
	Through						
	Right Turn						
	Subtotal	213	211	98.9%	1.3	0.4	A
SB	Left Turn	335	340	101.5%	2.1	0.8	A
	Through						
	Right Turn						
	Subtotal	350	355	101.3%	2.0	0.8	A
EB	Left Turn	31	33	105.2%	7.6	1.1	A
	Through						
	Right Turn						
	Subtotal	31	33	105.2%	7.6	1.1	A
WB	Left Turn						
	Through						
	Right Turn						
	Subtotal						
<b>Total</b>		<b>594</b>	<b>598</b>	<b>100.6%</b>	<b>2.1</b>	<b>0.6</b>	<b>A</b>

**Intersection 2**                      **Deer Valley Drive West/Doe Pass Road**                      **Side-street Stop**

Direction	Movement	Demand Volume (vph)	Served Volume (vph)		Total Delay (sec/veh)		LOS
			Average	Percent	Average	Std. Dev.	
NB	Left Turn	20	18	90.0%	5.9	1.5	A
	Through						
	Right Turn						
	Subtotal	20	18	90.0%	5.9	1.5	A
SB	Left Turn						
	Through						
	Right Turn						
	Subtotal						
EB	Left Turn	484	498	102.9%	2.3	0.3	A
	Through						
	Right Turn						
	Subtotal	504	520	103.2%	2.3	0.3	A
WB	Left Turn	30	33	108.3%	0.8	0.3	A
	Through						
	Right Turn						
	Subtotal	30	33	108.3%	0.8	0.3	A
<b>Total</b>		<b>554</b>	<b>570</b>	<b>103.0%</b>	<b>2.3</b>	<b>0.3</b>	<b>A</b>

**Intersection 3**                      **Deer Valley Drive East/Queen Esther Drive**                      **Side-street Stop**

Direction	Movement	Demand Volume (vph)	Served Volume (vph)		Total Delay (sec/veh)		
			Average	Percent	Average	Std. Dev.	LOS
NB	Left Turn						
	Through	269	268	99.8%	0.6	0.1	A
	Right Turn	20	24	118.5%	0.7	0.4	A
	Subtotal	289	292	101.1%	0.6	0.1	A
SB	Left Turn	50	47	93.4%	4.7	1.0	A
	Through	344	353	102.6%	1.6	0.3	A
	Right Turn						
	Subtotal	394	400	101.4%	2.0	0.4	A
EB	Left Turn						
	Through						
	Right Turn						
	Subtotal						
WB	Left Turn	20	20	100.0%	8.5	2.0	A
	Through						
	Right Turn	55	58	106.2%	5.6	0.4	A
	Subtotal	75	78	104.5%	6.4	0.7	A
Total		758	770	101.6%	1.9	0.3	A

**Intersection 4**                      **Solamere Drive/Deer Valley Drive East**                      **Side-street Stop**

Direction	Movement	Demand Volume (vph)	Served Volume (vph)		Total Delay (sec/veh)		
			Average	Percent	Average	Std. Dev.	LOS
NB	Left Turn						
	Through						
	Right Turn						
	Subtotal						
SB	Left Turn	25	23	93.6%	10.6	3.8	B
	Through						
	Right Turn	60	60	100.2%	7.1	1.9	A
	Subtotal	85	84	98.2%	8.1	2.2	A
EB	Left Turn	50	47	94.2%	5.7	0.9	A
	Through	369	374	101.4%	2.4	0.7	A
	Right Turn						
	Subtotal	419	421	100.6%	2.7	0.7	A
WB	Left Turn						
	Through	304	306	100.7%	1.0	0.2	A
	Right Turn	20	21	104.5%	0.8	0.7	A
	Subtotal	324	327	101.0%	1.0	0.1	A
Total		828	832	100.5%	2.7	0.6	A

**Intersection 5**                      **Deer Valley Drive West/Deer Valley Drive East**                      **Side-street Stop**

Direction	Movement	Demand Volume (vph)	Served Volume (vph)		Total Delay (sec/veh)		
			Average	Percent	Average	Std. Dev.	LOS
NB	Left Turn						
	Through	35	33	92.9%	8.4	2.5	A
	Right Turn	15	16	109.3%	8.0	4.2	A
	Subtotal	50	49	97.8%	8.3	2.5	A
SB	Left Turn	404	403	99.8%	1.2	0.1	A
	Through	494	507	102.6%	1.0	0.3	A
	Right Turn						
	Subtotal	898	910	101.3%	1.1	0.2	A
EB	Left Turn						
	Through						
	Right Turn						
	Subtotal						
WB	Left Turn	10	10	96.0%	9.9	6.7	A
	Through						
	Right Turn	354	353	99.7%	2.8	0.5	A
	Subtotal	364	363	99.6%	3.0	0.6	A
<b>Total</b>		<b>1,312</b>	<b>1,321</b>	<b>100.7%</b>	<b>1.9</b>	<b>0.3</b>	<b>A</b>

**Intersection 7**                      **Deer Valley Drive/Bonanza Drive**                      **Signal**

Direction	Movement	Demand Volume (vph)	Served Volume (vph)		Total Delay (sec/veh)		
			Average	Percent	Average	Std. Dev.	LOS
NB	Left Turn						
	Through	304	308	101.4%	14.8	2.3	B
	Right Turn	181	182	100.7%	3.3	0.4	A
	Subtotal	485	491	101.1%	10.6	1.7	B
SB	Left Turn	115	100	87.0%	14.0	2.1	B
	Through	677	628	92.8%	9.8	1.7	A
	Right Turn						
	Subtotal	792	728	91.9%	10.4	1.6	B
EB	Left Turn						
	Through						
	Right Turn						
	Subtotal						
WB	Left Turn	602	615	102.2%	15.9	1.4	B
	Through						
	Right Turn	215	221	102.7%	5.4	0.9	A
	Subtotal	817	836	102.4%	13.3	1.3	B
<b>Total</b>		<b>2,094</b>	<b>2,055</b>	<b>98.1%</b>	<b>11.7</b>	<b>1.1</b>	<b>B</b>

**Intersection 8 SR-224-Park Avenue/Empire Avenue-Deer Valley Drive Signal**

Direction	Movement	Demand Volume (vph)	Served Volume (vph)		Total Delay (sec/veh)		LOS
			Average	Percent	Average	Std. Dev.	
NB	Left Turn	55	53	96.7%	32.8	10.1	C
	Through	195	194	99.5%	52.7	7.2	D
	Right Turn	75	74	98.9%	21.6	8.3	C
	Subtotal	325	322	98.9%	42.2	5.4	D
SB	Left Turn	517	408	79.0%	209.9	17.9	F
	Through	170	137	80.7%	175.5	20.6	F
	Right Turn	1,065	876	82.3%	78.3	16.2	E
	Subtotal	1,752	1,422	81.1%	124.8	5.1	F
EB	Left Turn	385	390	101.3%	44.6	6.2	D
	Through	240	240	100.1%	30.4	5.4	C
	Right Turn	25	24	96.0%	23.4	10.3	C
	Subtotal	650	654	100.6%	38.6	4.9	D
WB	Left Turn	50	52	103.4%	83.8	16.3	F
	Through	325	367	112.8%	62.9	15.3	E
	Right Turn	254	259	101.8%	12.6	4.3	B
	Subtotal	629	677	107.6%	45.4	10.1	D
Total		3,356	3,074	91.6%	81.1	2.8	F

**Intersection 9 Monitor Drive-Bonanza Drive/SR-248 Signal**

Direction	Movement	Demand Volume (vph)	Served Volume (vph)		Total Delay (sec/veh)		LOS
			Average	Percent	Average	Std. Dev.	
NB	Left Turn	65	65	99.7%	23.2	6.2	C
	Through	30	28	93.0%	21.6	9.5	C
	Right Turn	126	118	94.0%	3.4	0.8	A
	Subtotal	221	211	95.5%	12.4	2.5	B
SB	Left Turn	60	61	101.0%	19.4	4.5	B
	Through	75	78	104.0%	27.9	6.7	C
	Right Turn	30	32	107.3%	5.1	1.5	A
	Subtotal	165	171	103.5%	20.7	3.5	C
EB	Left Turn	25	25	98.8%	12.7	5.8	B
	Through	250	261	104.3%	19.7	2.7	B
	Right Turn	100	103	102.5%	12.0	2.7	B
	Subtotal	375	388	103.5%	17.1	2.1	B
WB	Left Turn	322	329	102.1%	15.4	3.0	B
	Through	350	341	97.5%	7.7	1.8	A
	Right Turn	50	54	108.2%	5.9	1.9	A
	Subtotal	722	724	100.3%	11.1	2.2	B
Total		1,483	1,494	100.7%	13.9	2.0	B

**Intersection 1**                      **Deer Valley Drive East/Doe Pass Road**                      **Signal**

Direction	Movement	Demand Volume (vph)	Served Volume (vph)		Total Delay (sec/veh)		LOS
			Average	Percent	Average	Std. Dev.	
NB	Left Turn	885	891	100.7%	2.9	1.2	A
	Through						
	Right Turn						
	Subtotal						
SB	Left Turn	140	138	98.5%	1.2	0.4	A
	Through						
	Right Turn						
	Subtotal						
EB	Left Turn	26	25	96.9%	8.4	1.7	A
	Through						
	Right Turn						
	Subtotal						
WB	Left Turn						
	Through						
	Right Turn						
	Subtotal						
Total		1,066	1,073	100.6%	2.7	1.0	A

**Intersection 2**                      **Deer Valley Drive West/Doe Pass Road**                      **Side-street Stop**

Direction	Movement	Demand Volume (vph)	Served Volume (vph)		Total Delay (sec/veh)		LOS
			Average	Percent	Average	Std. Dev.	
NB	Left Turn	20	23	112.5%	5.3	0.9	A
	Through						
	Right Turn						
	Subtotal						
SB	Left Turn						
	Through						
	Right Turn						
	Subtotal						
EB	Left Turn	229	233	101.6%	1.4	0.3	A
	Through						
	Right Turn						
	Subtotal						
WB	Left Turn	60	66	109.7%	1.4	0.3	A
	Through						
	Right Turn						
	Subtotal						
Total		329	339	103.0%	1.6	0.2	A



**Intersection 3**                      **Deer Valley Drive East/Queen Esther Drive**                      **Side-street Stop**

Direction	Movement	Demand Volume (vph)	Served Volume (vph)		Total Delay (sec/veh)		
			Average	Percent	Average	Std. Dev.	LOS
NB	Left Turn						
	Through	915	929	101.6%	2.4	0.2	A
	Right Turn	30	33	110.0%	2.6	1.1	A
	Subtotal	945	962	101.8%	2.4	0.2	A
SB	Left Turn	85	83	98.0%	10.7	2.8	B
	Through	175	182	103.8%	3.8	1.6	A
	Right Turn						
	Subtotal	260	265	101.9%	6.0	1.8	A
EB	Left Turn						
	Through						
	Right Turn						
	Subtotal						
WB	Left Turn	30	29	98.0%	23.7	11.7	C
	Through						
	Right Turn	60	57	94.7%	16.7	7.4	C
	Subtotal	90	86	95.8%	19.1	7.9	C
Total		1,295	1,314	101.4%	4.1	0.8	A

**Intersection 4**                      **Solamere Drive/Deer Valley Drive East**                      **Side-street Stop**

Direction	Movement	Demand Volume (vph)	Served Volume (vph)		Total Delay (sec/veh)		
			Average	Percent	Average	Std. Dev.	LOS
NB	Left Turn						
	Through						
	Right Turn						
	Subtotal						
SB	Left Turn	20	18	89.0%	49.3	32.3	E
	Through						
	Right Turn	80	81	101.8%	26.2	9.2	D
	Subtotal	100	99	99.2%	29.0	9.3	D
EB	Left Turn	90	84	93.8%	15.5	6.9	C
	Through	240	244	101.5%	6.3	2.6	A
	Right Turn						
	Subtotal	330	328	99.4%	8.6	4.3	A
WB	Left Turn						
	Through	940	945	100.6%	2.2	0.2	A
	Right Turn	35	36	102.6%	2.3	0.6	A
	Subtotal	975	981	100.6%	2.2	0.2	A
Total		1,405	1,408	100.2%	5.4	1.4	A

**Intersection 5**                      **Deer Valley Drive West/Deer Valley Drive East**                      **Side-street Stop**

Direction	Movement	Demand Volume (vph)	Served Volume (vph)		Total Delay (sec/veh)		
			Average	Percent	Average	Std. Dev.	LOS
NB	Left Turn						
	Through	35	39	112.6%	7.0	0.4	A
	Right Turn	45	49	108.0%	5.3	1.8	A
	Subtotal	80	88	110.0%	6.0	1.0	A
SB	Left Turn	285	280	98.3%	0.8	0.1	A
	Through	224	227	101.5%	0.4	0.1	A
	Right Turn						
	Subtotal	509	508	99.7%	0.6	0.1	A
EB	Left Turn						
	Through						
	Right Turn						
	Subtotal						
WB	Left Turn	25	22	86.4%	18.0	7.1	C
	Through						
	Right Turn	995	1,000	100.5%	13.5	3.6	B
	Subtotal	1,020	1,022	100.2%	13.6	3.6	B
<b>Total</b>		<b>1,609</b>	<b>1,618</b>	<b>100.5%</b>	<b>9.1</b>	<b>2.1</b>	<b>A</b>

**Intersection 7**                      **Deer Valley Drive/Bonanza Drive**                      **Signal**

Direction	Movement	Demand Volume (vph)	Served Volume (vph)		Total Delay (sec/veh)		
			Average	Percent	Average	Std. Dev.	LOS
NB	Left Turn						
	Through	805	804	99.8%	41.1	32.7	D
	Right Turn	710	716	100.8%	37.0	50.3	D
	Subtotal	1,515	1,519	100.3%	39.2	41.2	D
SB	Left Turn	275	193	70.0%	23.4	8.6	C
	Through	512	414	80.8%	8.1	0.7	A
	Right Turn						
	Subtotal	787	606	77.0%	12.8	3.0	B
EB	Left Turn						
	Through						
	Right Turn						
	Subtotal						
WB	Left Turn	466	467	100.1%	25.7	9.4	C
	Through						
	Right Turn	145	149	102.8%	14.9	8.8	B
	Subtotal	611	616	100.8%	23.1	8.8	C
<b>Total</b>		<b>2,913</b>	<b>2,741</b>	<b>94.1%</b>	<b>30.1</b>	<b>24.6</b>	<b>C</b>

**Intersection 8**                      **SR-224-Park Avenue/Empire Avenue-Deer Valley Drive**                      **Signal**

Direction	Movement	Demand Volume (vph)	Served Volume (vph)		Total Delay (sec/veh)		LOS
			Average	Percent	Average	Std. Dev.	
NB	Left Turn	35	33	95.1%	39.2	10.8	D
	Through	395	383	97.0%	52.6	3.9	D
	Right Turn	70	72	102.9%	29.8	8.5	C
	Subtotal	500	489	97.7%	48.0	3.7	D
SB	Left Turn	547	375	68.6%	218.6	11.1	F
	Through	365	257	70.5%	183.2	18.4	F
	Right Turn	445	303	68.2%	54.1	9.3	D
	Subtotal	1,357	936	69.0%	154.6	9.1	F
EB	Left Turn	765	517	67.5%	84.2	5.5	F
	Through	355	248	69.8%	56.8	12.4	E
	Right Turn	50	33	65.2%	44.6	13.8	D
	Subtotal	1,170	797	68.1%	74.0	8.0	E
WB	Left Turn	80	73	91.3%	79.6	23.5	E
	Through	310	356	114.9%	58.0	15.0	E
	Right Turn	690	651	94.3%	46.8	6.1	D
	Subtotal	1,080	1,080	100.0%	52.9	5.4	D
<b>Total</b>		<b>4,107</b>	<b>3,302</b>	<b>80.4%</b>	<b>86.3</b>	<b>4.4</b>	<b>F</b>

**Intersection 9**                      **Monitor Drive-Bonanza Drive/SR-248**                      **Signal**

Direction	Movement	Demand Volume (vph)	Served Volume (vph)		Total Delay (sec/veh)		LOS
			Average	Percent	Average	Std. Dev.	
NB	Left Turn	180	168	93.1%	41.9	30.4	D
	Through	90	91	101.6%	38.0	15.1	D
	Right Turn	525	482	91.7%	15.9	8.7	B
	Subtotal	795	741	93.1%	24.6	14.3	C
SB	Left Turn	100	101	100.8%	34.6	6.7	C
	Through	55	56	101.1%	41.1	6.5	D
	Right Turn	65	66	100.8%	5.2	1.0	A
	Subtotal	220	222	100.9%	27.9	5.1	C
EB	Left Turn	75	74	98.5%	14.6	2.5	B
	Through	635	641	101.0%	26.0	3.7	C
	Right Turn	150	148	98.7%	19.5	6.0	B
	Subtotal	860	863	100.4%	24.0	3.5	C
WB	Left Turn	251	247	98.4%	21.2	2.9	C
	Through	420	423	100.6%	10.6	1.3	B
	Right Turn	50	53	106.4%	7.7	2.2	A
	Subtotal	721	723	100.2%	14.2	1.3	B
<b>Total</b>		<b>2,596</b>	<b>2,548</b>	<b>98.2%</b>	<b>21.9</b>	<b>5.6</b>	<b>C</b>

SimTraffic Post-Processor  
Average Results from 10 Runs  
Volume and Delay by Movement

Snow Park Village  
2040 Background  
AM Peak Hour

Intersection 3                      Deer Valley Drive East/Queen Esther Drive                      Side-street Stop

Direction	Movement	Demand Volume (vph)	Served Volume (vph)		Total Delay (sec/veh)		
			Average	Percent	Average	Std. Dev.	LOS
NB	Left Turn						
	Through	105	110	104.8%	0.3	0.2	A
	Right Turn	20	20	100.0%	0.1	0.2	A
	Subtotal	125	130	104.0%	0.3	0.2	A
SB	Left Turn	50	49	97.6%	3.9	0.6	A
	Through	160	169	105.3%	1.2	0.4	A
	Right Turn						
	Subtotal	210	217	103.5%	1.8	0.3	A
EB	Left Turn						
	Through						
	Right Turn						
	Subtotal						
WB	Left Turn	20	21	104.0%	6.9	2.0	A
	Through						
	Right Turn	55	56	100.9%	5.1	0.4	A
	Subtotal	75	76	101.7%	5.5	0.5	A
Total		410	424	103.3%	2.1	0.3	A

Intersection 4                      Solamere Drive/Deer Valley Drive East                      Side-street Stop

Direction	Movement	Demand Volume (vph)	Served Volume (vph)		Total Delay (sec/veh)		
			Average	Percent	Average	Std. Dev.	LOS
NB	Left Turn						
	Through						
	Right Turn						
	Subtotal						
SB	Left Turn	25	23	92.0%	7.5	2.2	A
	Through						
	Right Turn	60	64	106.5%	5.6	0.7	A
	Subtotal	85	87	102.2%	6.1	0.7	A
EB	Left Turn	50	49	97.8%	4.5	0.9	A
	Through	185	195	105.6%	1.5	0.4	A
	Right Turn						
	Subtotal	235	244	103.9%	2.2	0.4	A
WB	Left Turn						
	Through	140	145	103.7%	0.9	0.2	A
	Right Turn	20	19	97.0%	1.3	0.6	A
	Subtotal	160	165	102.9%	1.0	0.2	A
Total		480	496	103.3%	2.5	0.3	A

SimTraffic Post-Processor  
Average Results from 10 Runs  
Volume and Delay by Movement

Snow Park Village  
2040 Background  
AM Peak Hour

Intersection 5                      Deer Valley Drive West/Deer Valley Drive East                      Side-street Stop

Direction	Movement	Demand Volume (vph)	Served Volume (vph)		Total Delay (sec/veh)		
			Average	Percent	Average	Std. Dev.	LOS
NB	Left Turn						
	Through	185	188	101.4%	1.6	0.5	A
	Right Turn	15	17	110.7%	1.2	0.8	A
	Subtotal	200	204	102.1%	1.5	0.4	A
SB	Left Turn	220	227	103.3%	6.6	0.8	A
	Through	740	735	99.4%	4.3	0.4	A
	Right Turn						
	Subtotal	960	963	100.3%	4.8	0.4	A
EB	Left Turn						
	Through						
	Right Turn						
	Subtotal						
WB	Left Turn	10	11	106.0%	17.3	16.7	C
	Through						
	Right Turn	190	195	102.7%	4.8	0.4	A
	Subtotal	200	206	102.9%	5.5	0.9	A
Total		1,360	1,373	100.9%	4.4	0.3	A

Intersection 7                      Deer Valley Drive/Bonanza Drive                      Signal

Direction	Movement	Demand Volume (vph)	Served Volume (vph)		Total Delay (sec/veh)		
			Average	Percent	Average	Std. Dev.	LOS
NB	Left Turn						
	Through	275	273	99.4%	28.7	16.6	C
	Right Turn	200	195	97.7%	3.4	1.0	A
	Subtotal	475	469	98.7%	18.4	9.9	B
SB	Left Turn	125	102	81.6%	14.8	3.6	B
	Through	655	546	83.3%	10.3	1.2	B
	Right Turn						
	Subtotal	780	648	83.0%	11.0	1.2	B
EB	Left Turn						
	Through						
	Right Turn						
	Subtotal						
WB	Left Turn	700	707	101.0%	24.9	7.6	C
	Through						
	Right Turn	225	220	97.7%	14.7	9.5	B
	Subtotal	925	927	100.2%	22.5	7.9	C
Total		2,180	2,043	93.7%	18.0	5.9	B

SimTraffic Post-Processor  
Average Results from 10 Runs  
Volume and Delay by Movement

Snow Park Village  
2040 Background  
AM Peak Hour

Intersection 8 SR-224-Park Avenue/Empire Avenue-Deer Valley Drive Signal

Direction	Movement	Demand Volume (vph)	Served Volume (vph)		Total Delay (sec/veh)		
			Average	Percent	Average	Std. Dev.	LOS
NB	Left Turn	95	98	102.8%	31.5	5.0	C
	Through	195	194	99.3%	52.6	5.4	D
	Right Turn	70	69	98.9%	24.0	9.8	C
	Subtotal	360	361	100.1%	41.3	4.6	D
SB	Left Turn	480	305	63.5%	80.6	11.6	F
	Through	170	111	65.1%	76.7	11.0	E
	Right Turn	1,565	1,004	64.1%	122.1	2.4	F
	Subtotal	2,215	1,419	64.1%	109.3	3.2	F
EB	Left Turn	580	545	94.0%	73.7	6.0	E
	Through	360	335	93.0%	50.4	7.6	D
	Right Turn	45	43	95.8%	39.4	8.5	D
	Subtotal	985	923	93.7%	63.6	6.0	E
WB	Left Turn	50	44	88.6%	105.3	10.8	F
	Through	425	412	96.8%	99.5	8.2	F
	Right Turn	215	192	89.3%	14.7	4.5	B
	Subtotal	690	648	93.9%	74.9	6.9	E
Total		4,250	3,350	78.8%	83.0	2.5	F

Intersection 9 Monitor Drive-Bonanza Drive/SR-248 Signal

Direction	Movement	Demand Volume (vph)	Served Volume (vph)		Total Delay (sec/veh)		
			Average	Percent	Average	Std. Dev.	LOS
NB	Left Turn	75	67	89.3%	29.5	5.9	C
	Through	30	31	102.0%	25.6	4.5	C
	Right Turn	120	111	92.2%	4.7	1.3	A
	Subtotal	225	208	92.5%	15.7	2.7	B
SB	Left Turn	65	65	99.4%	27.1	7.1	C
	Through	75	74	98.0%	29.9	3.3	C
	Right Turn	35	36	102.0%	4.8	1.3	A
	Subtotal	175	174	99.3%	23.6	3.9	C
EB	Left Turn	25	25	98.4%	13.1	4.4	B
	Through	340	342	100.6%	21.6	2.7	C
	Right Turn	110	112	101.4%	12.9	3.8	B
	Subtotal	475	478	100.7%	19.0	2.7	B
WB	Left Turn	345	352	102.1%	17.2	2.1	B
	Through	475	473	99.6%	9.5	1.4	A
	Right Turn	55	57	103.5%	5.9	2.7	A
	Subtotal	875	883	100.9%	12.2	1.7	B
Total		1,750	1,743	99.6%	15.7	1.7	B

# MOVEMENT SUMMARY

 Site: 101 [2040 BG AM]

Deer Valley Drive / Marsac Avenue Roundabout  
 Site Category: (None)  
 Roundabout

Movement Performance - Vehicles												
Mov ID	Turn	Demand Total	Flows HV %	Deg. Satn v/c	Average Delay sec	Level of Service	95% Back of Queue Vehicles veh	Distance ft	Prop. Queued	Effective Stop Rate	Aver. No. Cycles	Average Speed mph
South: Marsac Avenue												
3	L2	5	100.0	0.219	16.5	LOS C	0.7	19.8	0.67	0.67	0.67	32.8
8	T1	133	3.0	0.219	10.0	LOS A	0.8	20.0	0.67	0.67	0.67	33.1
18b	R3	85	3.0	0.219	9.9	LOS A	0.8	20.0	0.68	0.68	0.68	31.5
Approach		223	5.3	0.219	10.1	LOS B	0.8	20.0	0.67	0.67	0.67	32.5
SouthEast: RoadName												
3bx	L3	48	3.0	0.175	4.7	LOS A	0.7	18.6	0.32	0.20	0.32	35.6
3ax	L1	21	100.0	0.175	7.6	LOS A	0.7	18.6	0.32	0.20	0.32	34.1
18ax	R1	319	3.0	0.175	4.6	LOS A	0.8	19.2	0.33	0.20	0.33	35.3
Approach		388	8.3	0.175	4.8	LOS A	0.8	19.2	0.33	0.20	0.33	35.3
North: Deer Valley Drive												
7u	U	27	3.0	0.877	23.2	LOS C	14.5	370.9	0.90	0.53	0.90	27.2
7a	L1	947	3.0	0.877	23.2	LOS C	14.5	370.9	0.90	0.53	0.90	26.5
4	T1	399	3.0	0.877	10.9	LOS B	14.5	370.9	0.46	0.26	0.46	32.3
14	R2	16	100.0	0.240	7.7	LOS A	1.1	28.2	0.25	0.13	0.25	34.2
Approach		1388	4.1	0.877	19.4	LOS C	14.5	370.9	0.77	0.44	0.77	28.0
West: Transit Center												
5	L2	5	100.0	0.234	24.0	LOS C	0.4	17.2	0.74	0.75	0.77	27.5
12a	R1	27	100.0	0.234	24.0	LOS C	0.4	17.2	0.74	0.75	0.77	27.2
12	R2	16	100.0	0.234	24.0	LOS C	0.4	17.2	0.74	0.75	0.77	26.6
Approach		48	100.0	0.234	24.0	LOS C	0.4	17.2	0.74	0.75	0.77	27.0
All Vehicles		2048	7.3	0.877	15.8	LOS C	14.5	370.9	0.67	0.43	0.67	29.6

Site Level of Service (LOS) Method: Delay & v/c (HCM 6). Site LOS Method is specified in the Parameter Settings dialog (Site tab).

Roundabout LOS Method: Same as Sign Control.

Vehicle movement LOS values are based on average delay and v/c ratio (degree of saturation) per movement.

LOS F will result if v/c > 1 irrespective of movement delay value (does not apply for approaches and intersection).

Intersection and Approach LOS values are based on average delay for all movements (v/c not used as specified in HCM 6).

Roundabout Capacity Model: US HCM 6.

HCM Delay Formula option is used. Control Delay does not include Geometric Delay since Exclude Geometric Delay option applies.

Gap-Acceptance Capacity: Traditional M1.

HV (%) values are calculated for All Movement Classes of All Heavy Vehicle Model Designation.



SimTraffic Post-Processor  
Average Results from 10 Runs  
Volume and Delay by Movement

Snow Park Village  
2040 Background  
PM Peak Hour

Intersection 3                      Deer Valley Drive East/Queen Esther Drive                      Side-street Stop

Direction	Movement	Demand Volume (vph)	Served Volume (vph)		Total Delay (sec/veh)		
			Average	Percent	Average	Std. Dev.	LOS
NB	Left Turn						
	Through	370	385	104.1%	1.2	0.2	A
	Right Turn	30	32	107.7%	0.6	0.5	A
	Subtotal	400	418	104.4%	1.2	0.2	A
SB	Left Turn	85	88	103.6%	5.2	0.6	A
	Through	125	121	97.0%	1.8	0.5	A
	Right Turn						
	Subtotal	210	209	99.7%	3.2	0.4	A
EB	Left Turn						
	Through						
	Right Turn						
	Subtotal						
WB	Left Turn	30	30	98.3%	9.1	3.8	A
	Through						
	Right Turn	60	63	104.8%	7.3	2.1	A
	Subtotal	90	92	102.7%	8.1	2.2	A
Total		700	719	102.8%	2.6	0.5	A

Intersection 4                      Solamere Drive/Deer Valley Drive East                      Side-street Stop

Direction	Movement	Demand Volume (vph)	Served Volume (vph)		Total Delay (sec/veh)		
			Average	Percent	Average	Std. Dev.	LOS
NB	Left Turn						
	Through						
	Right Turn						
	Subtotal						
SB	Left Turn	20	21	104.5%	15.0	6.1	B
	Through						
	Right Turn	80	79	98.1%	8.5	1.7	A
	Subtotal	100	99	99.4%	10.1	3.0	B
EB	Left Turn	90	94	104.8%	6.4	1.0	A
	Through	190	186	97.7%	2.1	0.5	A
	Right Turn						
	Subtotal	280	280	100.0%	3.6	0.6	A
WB	Left Turn						
	Through	395	412	104.4%	1.3	0.2	A
	Right Turn	35	37	105.1%	1.4	0.3	A
	Subtotal	430	449	104.4%	1.3	0.2	A
Total		810	828	102.3%	3.0	0.4	A

SimTraffic Post-Processor  
Average Results from 10 Runs  
Volume and Delay by Movement

Snow Park Village  
2040 Background  
PM Peak Hour

Intersection 5                      Deer Valley Drive West/Deer Valley Drive East                      Side-street Stop

Direction	Movement	Demand Volume (vph)	Served Volume (vph)		Total Delay (sec/veh)		
			Average	Percent	Average	Std. Dev.	LOS
NB	Left Turn						
	Through	645	641	99.4%	4.0	0.7	A
	Right Turn	45	48	107.6%	2.9	0.7	A
	Subtotal	690	690	100.0%	3.9	0.7	A
SB	Left Turn	235	232	98.6%	9.3	1.6	A
	Through	245	246	100.2%	1.8	0.4	A
	Right Turn						
	Subtotal	480	477	99.4%	5.4	1.0	A
EB	Left Turn						
	Through						
	Right Turn						
	Subtotal						
WB	Left Turn	25	27	106.4%	107.4	23.1	F
	Through						
	Right Turn	450	447	99.4%	111.6	22.5	F
	Subtotal	475	474	99.7%	111.5	22.3	F
Total		1,645	1,641	99.7%	35.5	4.8	E

Intersection 7                      Deer Valley Drive/Bonanza Drive                      Signal

Direction	Movement	Demand Volume (vph)	Served Volume (vph)		Total Delay (sec/veh)		
			Average	Percent	Average	Std. Dev.	LOS
NB	Left Turn						
	Through	785	771	98.2%	78.6	50.6	E
	Right Turn	820	786	95.9%	92.1	74.1	F
	Subtotal	1,605	1,558	97.0%	85.7	62.8	F
SB	Left Turn	290	189	65.2%	20.6	2.6	C
	Through	470	335	71.2%	8.6	2.2	A
	Right Turn						
	Subtotal	760	524	68.9%	12.8	2.1	B
EB	Left Turn						
	Through						
	Right Turn						
	Subtotal						
WB	Left Turn	530	526	99.2%	37.2	15.3	D
	Through						
	Right Turn	150	144	95.8%	20.4	8.7	C
	Subtotal	680	670	98.5%	33.5	14.1	C
Total		3,045	2,751	90.3%	59.2	37.7	E

SimTraffic Post-Processor  
Average Results from 10 Runs  
Volume and Delay by Movement

Snow Park Village  
2040 Background  
PM Peak Hour

Intersection 8 SR-224-Park Avenue/Empire Avenue-Deer Valley Drive Signal

Direction	Movement	Demand Volume (vph)	Served Volume (vph)		Total Delay (sec/veh)		
			Average	Percent	Average	Std. Dev.	LOS
NB	Left Turn	70	71	101.3%	35.7	8.6	D
	Through	395	396	100.4%	54.8	5.5	D
	Right Turn	70	74	105.0%	41.2	9.5	D
	Subtotal	535	541	101.1%	50.6	5.6	D
SB	Left Turn	495	355	71.8%	216.3	16.0	F
	Through	365	259	71.1%	177.6	10.4	F
	Right Turn	720	524	72.7%	55.9	7.5	E
	Subtotal	1,580	1,138	72.0%	135.6	10.3	F
EB	Left Turn	1,190	527	44.3%	96.1	7.7	F
	Through	445	201	45.2%	75.2	18.2	E
	Right Turn	70	32	45.9%	64.1	23.0	E
	Subtotal	1,705	761	44.6%	89.7	9.7	F
WB	Left Turn	75	64	85.7%	122.1	17.2	F
	Through	405	396	97.7%	88.9	5.2	F
	Right Turn	640	546	85.3%	37.1	5.8	D
	Subtotal	1,120	1,006	89.8%	63.6	3.7	E
Total		4,940	3,445	69.7%	90.0	3.0	F

Intersection 9 Monitor Drive-Bonanza Drive/SR-248 Signal

Direction	Movement	Demand Volume (vph)	Served Volume (vph)		Total Delay (sec/veh)		
			Average	Percent	Average	Std. Dev.	LOS
NB	Left Turn	210	181	86.3%	51.9	15.5	D
	Through	90	85	94.4%	43.4	12.4	D
	Right Turn	565	508	89.8%	18.1	4.9	B
	Subtotal	865	774	89.5%	29.4	7.6	C
SB	Left Turn	105	103	97.7%	35.5	11.6	D
	Through	55	56	101.3%	47.5	6.9	D
	Right Turn	75	76	101.9%	6.4	1.6	A
	Subtotal	235	235	99.9%	28.6	4.7	C
EB	Left Turn	85	90	105.8%	18.2	2.9	B
	Through	865	882	101.9%	37.7	7.4	D
	Right Turn	175	172	98.2%	34.7	9.8	C
	Subtotal	1,125	1,144	101.6%	35.8	7.3	D
WB	Left Turn	255	252	98.6%	25.9	2.6	C
	Through	570	561	98.4%	12.7	1.8	B
	Right Turn	55	54	98.9%	8.3	2.7	A
	Subtotal	880	867	98.5%	16.4	1.3	B
Total		3,105	3,019	97.2%	28.1	3.0	C

# MOVEMENT SUMMARY

 Site: 101 [2040 BG PM]

Deer Valley Drive / Marsac Avenue Roundabout  
 Site Category: (None)  
 Roundabout

Movement Performance - Vehicles												
Mov ID	Turn	Demand Total	Flows HV %	Deg. Satn v/c	Average Delay sec	Level of Service	95% Back of Queue Vehicles veh	Distance ft	Prop. Queued	Effective Stop Rate	Aver. No. Cycles	Average Speed mph
South: Marsac Avenue												
3	L2	1	100.0	0.402	15.4	LOS C	2.0	51.3	0.68	0.74	0.87	32.2
8	T1	475	3.0	0.402	10.6	LOS B	2.0	51.3	0.68	0.74	0.87	33.0
18b	R3	86	3.0	0.402	10.6	LOS B	2.0	51.3	0.68	0.74	0.87	31.4
Approach		562	3.2	0.402	10.6	LOS B	2.0	51.3	0.68	0.74	0.87	32.8
SouthEast: RoadName												
3bx	L3	51	3.0	0.681	19.2	LOS C	5.8	151.3	0.81	1.08	1.61	29.7
3ax	L1	15	100.0	0.681	24.1	LOS C	5.8	151.3	0.81	1.08	1.61	28.4
18ax	R1	864	3.0	0.681	19.1	LOS C	6.0	152.4	0.82	1.08	1.61	29.1
Approach		929	4.6	0.681	19.2	LOS C	6.0	152.4	0.82	1.08	1.61	29.1
North: Deer Valley Drive												
7u	U	247	3.0	0.695	12.5	LOS B	6.9	176.1	0.48	0.26	0.48	31.0
7a	L1	434	3.0	0.695	12.5	LOS B	6.9	176.1	0.48	0.26	0.48	30.1
4	T1	429	3.0	0.695	8.3	LOS A	6.9	176.1	0.34	0.17	0.34	33.1
14	R2	10	100.0	0.190	7.1	LOS A	0.8	21.5	0.22	0.10	0.22	34.5
Approach		1121	3.9	0.695	10.8	LOS B	6.9	176.1	0.43	0.22	0.43	31.4
West: Transit Center												
5	L2	5	100.0	0.098	16.0	LOS C	0.2	7.2	0.65	0.65	0.65	30.3
12a	R1	15	100.0	0.098	16.0	LOS C	0.2	7.2	0.65	0.65	0.65	29.9
12	R2	5	100.0	0.098	16.0	LOS C	0.2	7.2	0.65	0.65	0.65	29.2
Approach		25	100.0	0.098	16.0	LOS C	0.2	7.2	0.65	0.65	0.65	29.8
All Vehicles		2637	4.9	0.695	13.8	LOS B	6.9	176.1	0.62	0.64	0.94	30.8

Site Level of Service (LOS) Method: Delay & v/c (HCM 6). Site LOS Method is specified in the Parameter Settings dialog (Site tab).

Roundabout LOS Method: Same as Sign Control.

Vehicle movement LOS values are based on average delay and v/c ratio (degree of saturation) per movement.

LOS F will result if v/c > 1 irrespective of movement delay value (does not apply for approaches and intersection).

Intersection and Approach LOS values are based on average delay for all movements (v/c not used as specified in HCM 6).

Roundabout Capacity Model: US HCM 6.

HCM Delay Formula option is used. Control Delay does not include Geometric Delay since Exclude Geometric Delay option applies.

Gap-Acceptance Capacity: Traditional M1.

HV (%) values are calculated for All Movement Classes of All Heavy Vehicle Model Designation.

**Intersection 1**                      **Deer Valley Drive East/Doe Pass Road**                      **Signal**

Direction	Movement	Demand Volume (vph)	Served Volume (vph)		Total Delay (sec/veh)		LOS
			Average	Percent	Average	Std. Dev.	
NB	Left Turn						
	Through	128	133	104.1%	1.2	0.6	A
	Right Turn						
	Subtotal	128	133	104.1%	1.2	0.6	A
SB	Left Turn						
	Through	208	213	102.4%	1.7	0.6	A
	Right Turn	15	14	94.7%	1.4	1.2	A
	Subtotal	223	227	101.8%	1.7	0.5	A
EB	Left Turn	31	30	97.4%	7.0	1.2	A
	Through						
	Right Turn						
	Subtotal	31	30	97.4%	7.0	1.2	A
WB	Left Turn						
	Through						
	Right Turn						
	Subtotal						
<b>Total</b>		<b>382</b>	<b>391</b>	<b>102.2%</b>	<b>1.9</b>	<b>0.6</b>	<b>A</b>

**Intersection 2**                      **Deer Valley Drive West/Doe Pass Road**                      **Side-street Stop**

Direction	Movement	Demand Volume (vph)	Served Volume (vph)		Total Delay (sec/veh)		LOS
			Average	Percent	Average	Std. Dev.	
NB	Left Turn	20	22	108.5%	9.6	3.3	A
	Through						
	Right Turn						
	Subtotal	20	22	108.5%	9.6	3.3	A
SB	Left Turn						
	Through						
	Right Turn						
	Subtotal						
EB	Left Turn						
	Through	756	754	99.7%	3.4	0.2	A
	Right Turn	20	21	103.0%	3.4	1.8	A
	Subtotal	776	775	99.8%	3.4	0.2	A
WB	Left Turn						
	Through	180	177	98.2%	1.9	0.1	A
	Right Turn						
	Subtotal	180	177	98.2%	1.9	0.1	A
<b>Total</b>		<b>976</b>	<b>973</b>	<b>99.7%</b>	<b>3.3</b>	<b>0.2</b>	<b>A</b>

**Intersection 3**                      **Deer Valley Drive East/Queen Esther Drive**                      **Side-street Stop**

Direction	Movement	Demand Volume (vph)	Served Volume (vph)		Total Delay (sec/veh)		
			Average	Percent	Average	Std. Dev.	LOS
NB	Left Turn						
	Through	184	191	104.0%	0.6	0.1	A
	Right Turn	20	20	101.5%	0.4	0.5	A
	Subtotal	204	212	103.8%	0.5	0.1	A
SB	Left Turn	50	53	106.8%	4.4	0.7	A
	Through	217	224	103.0%	1.1	0.3	A
	Right Turn						
	Subtotal	267	277	103.7%	1.8	0.4	A
EB	Left Turn						
	Through						
	Right Turn						
	Subtotal						
WB	Left Turn	20	19	95.0%	6.5	1.6	A
	Through						
	Right Turn	55	58	105.6%	5.5	0.8	A
	Subtotal	75	77	102.8%	5.8	0.7	A
Total		546	566	103.6%	1.9	0.2	A

**Intersection 4**                      **Solamere Drive/Deer Valley Drive East**                      **Side-street Stop**

Direction	Movement	Demand Volume (vph)	Served Volume (vph)		Total Delay (sec/veh)		
			Average	Percent	Average	Std. Dev.	LOS
NB	Left Turn						
	Through						
	Right Turn						
	Subtotal						
SB	Left Turn	25	24	97.6%	7.8	2.8	A
	Through						
	Right Turn	60	59	98.8%	6.6	1.0	A
	Subtotal	85	84	98.5%	7.0	1.3	A
EB	Left Turn	50	47	94.8%	4.9	1.0	A
	Through	242	251	103.7%	1.7	0.3	A
	Right Turn						
	Subtotal	292	298	102.2%	2.1	0.3	A
WB	Left Turn						
	Through	219	231	105.5%	1.0	0.1	A
	Right Turn	20	18	90.5%	0.4	0.4	A
	Subtotal	239	249	104.3%	0.9	0.1	A
Total		616	631	102.5%	2.4	0.3	A

SimTraffic Post-Processor  
Average Results from 10 Runs  
Volume and Delay by Movement

Snow Park Village  
2040 Plus Project  
AM Peak Hour

**Intersection 5**                      **Deer Valley Drive West/Deer Valley Drive East**                      **Side-street Stop**

Direction	Movement	Demand Volume (vph)	Served Volume (vph)		Total Delay (sec/veh)		
			Average	Percent	Average	Std. Dev.	LOS
NB	Left Turn						
	Through	185	183	98.8%	1.3	0.3	A
	Right Turn	15	16	106.7%	1.6	1.3	A
	Subtotal	200	199	99.4%	1.3	0.3	A
SB	Left Turn	277	282	101.8%	7.7	1.4	A
	Through	766	758	98.9%	4.7	0.6	A
	Right Turn						
	Subtotal	1,043	1,040	99.7%	5.5	0.8	A
EB	Left Turn						
	Through						
	Right Turn						
	Subtotal						
WB	Left Turn	10	11	105.0%	33.3	22.6	D
	Through						
	Right Turn	269	280	104.1%	7.3	1.7	A
	Subtotal	279	291	104.1%	8.2	1.9	A
Total		1,522	1,529	100.4%	5.5	0.6	A

**Intersection 7**                      **Deer Valley Drive/Bonanza Drive**                      **Signal**

Direction	Movement	Demand Volume (vph)	Served Volume (vph)		Total Delay (sec/veh)		
			Average	Percent	Average	Std. Dev.	LOS
NB	Left Turn						
	Through	314	306	97.3%	21.0	10.9	C
	Right Turn	216	217	100.6%	3.3	0.7	A
	Subtotal	530	523	98.6%	13.9	7.0	B
SB	Left Turn	125	98	78.3%	12.2	1.4	B
	Through	697	587	84.2%	8.9	1.2	A
	Right Turn						
	Subtotal	822	685	83.3%	9.4	1.1	A
EB	Left Turn						
	Through						
	Right Turn						
	Subtotal						
WB	Left Turn	717	722	100.7%	22.8	8.0	C
	Through						
	Right Turn	225	222	98.8%	13.5	15.2	B
	Subtotal	942	944	100.2%	20.7	9.6	C
Total		2,294	2,152	93.8%	15.4	5.6	B



**Intersection 8**                      **SR-224-Park Avenue/Empire Avenue-Deer Valley Drive**                      **Signal**

Direction	Movement	Demand Volume (vph)	Served Volume (vph)		Total Delay (sec/veh)		LOS
			Average	Percent	Average	Std. Dev.	
NB	Left Turn	95	89	93.8%	34.0	7.9	C
	Through	195	200	102.3%	49.5	5.0	D
	Right Turn	70	71	101.1%	23.4	9.3	C
	Subtotal	360	359	99.8%	40.9	5.1	D
SB	Left Turn	522	330	63.1%	81.7	10.2	F
	Through	170	108	63.6%	70.1	11.1	E
	Right Turn	1,565	1,008	64.4%	120.1	3.4	F
	Subtotal	2,257	1,445	64.0%	107.6	3.2	F
EB	Left Turn	580	535	92.3%	75.7	8.1	E
	Through	360	332	92.1%	53.2	15.6	D
	Right Turn	45	44	97.1%	48.1	17.2	D
	Subtotal	985	911	92.4%	66.1	10.3	E
WB	Left Turn	50	47	94.0%	111.8	11.8	F
	Through	425	404	95.2%	99.5	6.2	F
	Right Turn	254	230	90.4%	15.3	4.1	B
	Subtotal	729	681	93.4%	71.2	4.4	E
<b>Total</b>		<b>4,331</b>	<b>3,396</b>	<b>78.4%</b>	<b>82.2</b>	<b>2.7</b>	<b>F</b>

**Intersection 9**                      **Monitor Drive-Bonanza Drive/SR-248**                      **Signal**

Direction	Movement	Demand Volume (vph)	Served Volume (vph)		Total Delay (sec/veh)		LOS
			Average	Percent	Average	Std. Dev.	
NB	Left Turn	75	69	91.6%	31.3	7.4	C
	Through	30	27	90.3%	30.1	10.9	C
	Right Turn	136	126	92.8%	3.7	0.9	A
	Subtotal	241	222	92.1%	15.6	4.0	B
SB	Left Turn	65	64	98.8%	23.3	3.7	C
	Through	75	77	102.1%	33.5	6.5	C
	Right Turn	35	39	110.3%	5.3	1.1	A
	Subtotal	175	179	102.5%	23.9	4.0	C
EB	Left Turn	25	27	106.0%	14.7	5.8	B
	Through	340	342	100.6%	22.6	1.5	C
	Right Turn	110	107	97.5%	14.9	2.5	B
	Subtotal	475	476	100.2%	20.4	1.2	C
WB	Left Turn	362	369	102.0%	18.8	2.0	B
	Through	475	485	102.0%	9.9	0.9	A
	Right Turn	55	56	101.6%	7.3	3.1	A
	Subtotal	892	910	102.0%	13.5	1.3	B
<b>Total</b>		<b>1,783</b>	<b>1,787</b>	<b>100.2%</b>	<b>16.6</b>	<b>1.4</b>	<b>B</b>

# MOVEMENT SUMMARY

 Site: 101 [2040 Plus Project AM]

Deer Valley Drive / Marsac Avenue Roundabout  
 Site Category: (None)  
 Roundabout

Movement Performance - Vehicles												
Mov ID	Turn	Demand Total	Flows HV %	Deg. Satn v/c	Average Delay sec	Level of Service	95% Back of Vehicles veh	Queue Distance ft	Prop. Queued	Effective Stop Rate	Aver. No. Cycles	Average Speed mph
South: Marsac Avenue												
3	L2	5	100.0	0.245	18.2	LOS C	0.8	22.1	0.71	0.71	0.71	32.3
8	T1	133	3.0	0.245	11.2	LOS B	0.9	22.3	0.71	0.71	0.71	32.5
18b	R3	94	3.0	0.245	11.1	LOS B	0.9	22.3	0.71	0.71	0.71	31.0
Approach		232	5.2	0.245	11.3	LOS B	0.9	22.3	0.71	0.71	0.71	31.9
SouthEast: RoadName												
3bx	L3	56	3.0	0.213	5.1	LOS A	0.8	23.4	0.33	0.21	0.33	35.4
3ax	L1	26	100.0	0.213	8.0	LOS A	0.8	23.4	0.33	0.21	0.33	33.9
18ax	R1	390	3.0	0.213	5.0	LOS A	0.9	24.2	0.34	0.21	0.34	35.1
Approach		472	8.2	0.213	5.2	LOS A	0.9	24.2	0.34	0.21	0.34	35.1
North: Deer Valley Drive												
7u	U	27	3.0	0.939	31.6	LOS D	47.7	1222.0	1.00	1.00	1.71	24.8
7a	L1	1022	3.0	0.939	31.6	LOS D	47.7	1222.0	1.00	1.00	1.71	24.2
4	T1	399	3.0	0.939	12.6	LOS B	47.7	1222.0	0.48	0.39	0.68	31.5
14	R2	16	100.0	0.257	8.0	LOS A	1.1	30.6	0.28	0.15	0.28	34.1
Approach		1464	4.1	0.939	26.2	LOS D	47.7	1222.0	0.85	0.82	1.42	25.9
West: Transit Center												
5	L2	5	100.0	0.274	27.3	LOS D	0.5	21.2	0.76	0.83	0.98	26.5
12a	R1	31	100.0	0.274	27.3	LOS D	0.5	21.2	0.76	0.83	0.98	26.2
12	R2	16	100.0	0.274	27.3	LOS D	0.5	21.2	0.76	0.83	0.98	25.7
Approach		52	100.0	0.274	27.3	LOS D	0.5	21.2	0.76	0.83	0.98	26.0
All Vehicles		2220	7.3	0.939	20.2	LOS C	47.7	1222.0	0.72	0.68	1.10	28.0

Site Level of Service (LOS) Method: Delay & v/c (HCM 6). Site LOS Method is specified in the Parameter Settings dialog (Site tab).

Roundabout LOS Method: Same as Sign Control.

Vehicle movement LOS values are based on average delay and v/c ratio (degree of saturation) per movement.

LOS F will result if v/c > 1 irrespective of movement delay value (does not apply for approaches and intersection).

Intersection and Approach LOS values are based on average delay for all movements (v/c not used as specified in HCM 6).

Roundabout Capacity Model: US HCM 6.

HCM Delay Formula option is used. Control Delay does not include Geometric Delay since Exclude Geometric Delay option applies.

Gap-Acceptance Capacity: Traditional M1.

HV (%) values are calculated for All Movement Classes of All Heavy Vehicle Model Designation.

SIDRA INTERSECTION 8.0 | Copyright © 2000-2019 Akcelik and Associates Pty Ltd | sidrasolutions.com

Organisation: FEHR AND PEERS | Processed: Saturday, July 23, 2022 11:30:18 AM

Project: C:\Users\syamagata\Desktop\Projects\Snow Park Village\July 2022 TIS Update\SIDRA\DeerValleyDrRoundabout.sip8

**Intersection 1**                      **Deer Valley Drive East/Doe Pass Road**                      **Signal**

Direction	Movement	Demand Volume (vph)	Served Volume (vph)		Total Delay (sec/veh)		LOS
			Average	Percent	Average	Std. Dev.	
NB	Left Turn						
	Through	440	444	100.8%	2.0	2.2	A
	Right Turn						
	Subtotal	440	444	100.8%	2.0	2.2	A
SB	Left Turn						
	Through	180	178	98.8%	1.4	0.6	A
	Right Turn	15	16	104.0%	0.9	1.6	A
	Subtotal	195	193	99.2%	1.3	0.6	A
EB	Left Turn	26	26	99.6%	9.0	4.1	A
	Through						
	Right Turn						
	Subtotal	26	26	99.6%	9.0	4.1	A
WB	Left Turn						
	Through						
	Right Turn						
	Subtotal						
<b>Total</b>		<b>661</b>	<b>663</b>	<b>100.3%</b>	<b>2.1</b>	<b>1.6</b>	<b>A</b>

**Intersection 2**                      **Deer Valley Drive West/Doe Pass Road**                      **Side-street Stop**

Direction	Movement	Demand Volume (vph)	Served Volume (vph)		Total Delay (sec/veh)		LOS
			Average	Percent	Average	Std. Dev.	
NB	Left Turn	20	21	107.0%	16.3	7.1	C
	Through						
	Right Turn						
	Subtotal	20	21	107.0%	16.3	7.1	C
SB	Left Turn						
	Through						
	Right Turn						
	Subtotal						
EB	Left Turn						
	Through	264	265	100.4%	1.7	0.3	A
	Right Turn	20	18	88.5%	1.1	1.1	A
	Subtotal	284	283	99.6%	1.7	0.3	A
WB	Left Turn						
	Through	670	679	101.3%	2.6	0.1	A
	Right Turn						
	Subtotal	670	679	101.3%	2.6	0.1	A
<b>Total</b>		<b>974</b>	<b>983</b>	<b>100.9%</b>	<b>2.7</b>	<b>0.3</b>	<b>A</b>

SimTraffic Post-Processor  
Average Results from 10 Runs  
Volume and Delay by Movement

Snow Park Village  
2040 Plus Project  
PM Peak Hour

**Intersection 3**                      **Deer Valley Drive East/Queen Esther Drive**                      **Side-street Stop**

Direction	Movement	Demand Volume (vph)	Served Volume (vph)		Total Delay (sec/veh)		
			Average	Percent	Average	Std. Dev.	LOS
NB	Left Turn						
	Through	470	454	96.5%	117.8	82.3	F
	Right Turn	30	32	105.3%	116.9	92.6	F
	Subtotal	500	485	97.0%	118.4	83.1	F
SB	Left Turn	85	83	98.1%	4.6	0.7	A
	Through	215	218	101.3%	1.3	0.3	A
	Right Turn						
	Subtotal	300	301	100.4%	2.2	0.4	A
EB	Left Turn						
	Through						
	Right Turn						
	Subtotal						
WB	Left Turn	30	26	87.7%	413.9	364.1	F
	Through						
	Right Turn	60	52	87.2%	433.0	356.0	F
	Subtotal	90	79	87.3%	157.5	186.7	F
Total		890	865	97.2%	75.3	46.6	F

**Intersection 4**                      **Solamere Drive/Deer Valley Drive East**                      **Side-street Stop**

Direction	Movement	Demand Volume (vph)	Served Volume (vph)		Total Delay (sec/veh)		
			Average	Percent	Average	Std. Dev.	LOS
NB	Left Turn						
	Through						
	Right Turn						
	Subtotal						
SB	Left Turn	20	15	74.5%	396.6	289.0	F
	Through						
	Right Turn	80	55	68.9%	394.9	266.5	F
	Subtotal	100	70	70.0%	215.4	148.1	F
EB	Left Turn	90	92	102.0%	5.0	0.9	A
	Through	280	283	100.9%	2.2	0.4	A
	Right Turn						
	Subtotal	370	374	101.2%	2.9	0.3	A
WB	Left Turn						
	Through	495	451	91.1%	144.6	23.4	F
	Right Turn	35	36	101.4%	143.0	39.8	F
	Subtotal	530	486	91.7%	144.3	24.3	F
Total		1,000	931	93.1%	90.2	20.7	F

SimTraffic Post-Processor  
Average Results from 10 Runs  
Volume and Delay by Movement

Snow Park Village  
2040 Plus Project  
PM Peak Hour

**Intersection 5**                      **Deer Valley Drive West/Deer Valley Drive East**                      **Side-street Stop**

Direction	Movement	Demand Volume (vph)	Served Volume (vph)		Total Delay (sec/veh)		
			Average	Percent	Average	Std. Dev.	LOS
NB	Left Turn						
	Through	645	654	101.4%	3.0	0.3	A
	Right Turn	45	47	104.7%	2.5	1.0	A
	Subtotal	690	701	101.6%	3.0	0.3	A
SB	Left Turn	325	328	101.0%	13.3	4.7	B
	Through	259	262	101.0%	2.6	0.7	A
	Right Turn						
	Subtotal	584	590	101.0%	8.6	2.6	A
EB	Left Turn						
	Through						
	Right Turn						
	Subtotal						
WB	Left Turn	25	22	86.0%	166.7	37.2	F
	Through						
	Right Turn	550	436	79.3%	134.9	10.2	F
	Subtotal	575	458	79.6%	136.7	10.9	F
Total		1,849	1,748	94.6%	40.2	0.7	E

**Intersection 7**                      **Deer Valley Drive/Bonanza Drive**                      **Signal**

Direction	Movement	Demand Volume (vph)	Served Volume (vph)		Total Delay (sec/veh)		
			Average	Percent	Average	Std. Dev.	LOS
NB	Left Turn						
	Through	835	798	95.5%	141.2	68.0	F
	Right Turn	840	793	94.3%	174.1	91.5	F
	Subtotal	1,675	1,590	94.9%	157.4	78.4	F
SB	Left Turn	290	182	62.6%	21.2	3.7	C
	Through	522	355	68.0%	8.4	1.3	A
	Right Turn						
	Subtotal	812	536	66.1%	12.7	1.8	B
EB	Left Turn						
	Through						
	Right Turn						
	Subtotal						
WB	Left Turn	551	560	101.7%	33.6	8.1	C
	Through						
	Right Turn	150	153	102.1%	22.3	8.8	C
	Subtotal	701	713	101.8%	31.0	8.2	C
Total		3,188	2,840	89.1%	97.3	41.9	F

**Intersection 8**                      **SR-224-Park Avenue/Empire Avenue-Deer Valley Drive**                      **Signal**

Direction	Movement	Demand Volume (vph)	Served Volume (vph)		Total Delay (sec/veh)		LOS
			Average	Percent	Average	Std. Dev.	
NB	Left Turn	70	67	95.1%	41.0	8.8	D
	Through	395	394	99.7%	52.3	3.9	D
	Right Turn	70	73	104.7%	35.5	12.6	D
	Subtotal	535	534	99.7%	48.6	4.0	D
SB	Left Turn	547	362	66.2%	224.7	12.9	F
	Through	365	241	65.9%	185.1	14.0	F
	Right Turn	720	478	66.3%	59.8	9.2	E
	Subtotal	1,632	1,080	66.2%	141.8	10.7	F
EB	Left Turn	1,190	530	44.5%	86.6	4.6	F
	Through	445	201	45.2%	62.9	11.5	E
	Right Turn	70	34	49.0%	53.9	19.0	D
	Subtotal	1,705	766	44.9%	79.2	6.3	E
WB	Left Turn	75	66	88.3%	118.6	18.3	F
	Through	405	397	97.9%	94.0	6.3	F
	Right Turn	690	578	83.7%	40.9	5.2	D
	Subtotal	1,170	1,040	88.9%	66.4	2.9	E
<b>Total</b>		<b>5,042</b>	<b>3,420</b>	<b>67.8%</b>	<b>89.9</b>	<b>2.3</b>	<b>F</b>

**Intersection 9**                      **Monitor Drive-Bonanza Drive/SR-248**                      **Signal**

Direction	Movement	Demand Volume (vph)	Served Volume (vph)		Total Delay (sec/veh)		LOS
			Average	Percent	Average	Std. Dev.	
NB	Left Turn	210	188	89.4%	62.1	22.8	E
	Through	90	90	99.8%	44.4	14.3	D
	Right Turn	585	515	88.0%	22.8	10.6	C
	Subtotal	885	793	89.5%	35.3	13.9	D
SB	Left Turn	105	102	97.4%	39.6	9.8	D
	Through	55	52	93.8%	46.7	10.1	D
	Right Turn	75	74	98.0%	6.3	1.1	A
	Subtotal	235	227	96.8%	30.2	5.6	C
EB	Left Turn	85	88	103.2%	22.0	3.0	C
	Through	865	867	100.2%	42.7	5.2	D
	Right Turn	175	177	101.0%	41.1	7.7	D
	Subtotal	1,125	1,131	100.6%	40.9	5.3	D
WB	Left Turn	276	275	99.6%	24.4	4.5	C
	Through	570	564	98.9%	12.4	1.7	B
	Right Turn	55	52	95.3%	9.3	3.7	A
	Subtotal	901	891	98.9%	15.9	1.8	B
<b>Total</b>		<b>3,146</b>	<b>3,042</b>	<b>96.7%</b>	<b>31.5</b>	<b>4.1</b>	<b>C</b>

# MOVEMENT SUMMARY

 Site: 101 [2040 Plus Project PM]

Deer Valley Drive / Marsac Avenue Roundabout  
 Site Category: (None)  
 Roundabout

Movement Performance - Vehicles												
Mov ID	Turn	Demand Total	Flows HV %	Deg. Satn v/c	Average Delay sec	Level of Service	95% Back of Queue Vehicles	Distance ft	Prop. Queued	Effective Stop Rate	Aver. No. Cycles	Average Speed mph
South: Marsac Avenue												
3	L2	1	100.0	0.447	17.6	LOS C	2.3	59.9	0.71	0.81	1.01	31.4
8	T1	475	3.0	0.447	12.3	LOS B	2.3	60.0	0.71	0.81	1.01	32.2
18b	R3	96	3.0	0.447	12.3	LOS B	2.3	60.0	0.71	0.81	1.01	30.7
Approach		572	3.2	0.447	12.3	LOS B	2.3	60.0	0.71	0.81	1.01	32.0
SouthEast: RoadName												
3bx	L3	61	3.0	0.753	23.4	LOS C	7.7	202.0	0.85	1.21	1.93	28.1
3ax	L1	20	100.0	0.753	28.3	LOS D	7.7	202.0	0.85	1.21	1.93	27.0
18ax	R1	949	3.0	0.753	23.2	LOS C	7.9	203.4	0.86	1.21	1.92	27.6
Approach		1030	4.9	0.753	23.3	LOS C	7.9	203.4	0.86	1.21	1.92	27.6
North: Deer Valley Drive												
7u	U	242	3.0	0.762	15.2	LOS C	8.6	220.1	0.62	0.36	0.62	29.9
7a	L1	524	3.0	0.762	15.2	LOS C	8.6	220.1	0.62	0.36	0.62	29.0
4	T1	429	3.0	0.762	9.3	LOS A	8.6	220.1	0.41	0.23	0.41	32.7
14	R2	10	100.0	0.208	7.4	LOS A	0.9	23.8	0.25	0.13	0.25	34.4
Approach		1206	3.8	0.762	13.0	LOS B	8.6	220.1	0.54	0.31	0.54	30.5
West: Transit Center												
5	L2	5	100.0	0.128	18.1	LOS C	0.2	9.4	0.68	0.68	0.68	29.6
12a	R1	20	100.0	0.128	18.1	LOS C	0.2	9.4	0.68	0.68	0.68	29.2
12	R2	5	100.0	0.128	18.1	LOS C	0.2	9.4	0.68	0.68	0.68	28.6
Approach		30	100.0	0.128	18.1	LOS C	0.2	9.4	0.68	0.68	0.68	29.1
All Vehicles		2838	5.1	0.762	16.7	LOS C	8.6	220.1	0.69	0.74	1.14	29.6

Site Level of Service (LOS) Method: Delay & v/c (HCM 6). Site LOS Method is specified in the Parameter Settings dialog (Site tab).

Roundabout LOS Method: Same as Sign Control.

Vehicle movement LOS values are based on average delay and v/c ratio (degree of saturation) per movement.

LOS F will result if v/c > 1 irrespective of movement delay value (does not apply for approaches and intersection).

Intersection and Approach LOS values are based on average delay for all movements (v/c not used as specified in HCM 6).

Roundabout Capacity Model: US HCM 6.

HCM Delay Formula option is used. Control Delay does not include Geometric Delay since Exclude Geometric Delay option applies.

Gap-Acceptance Capacity: Traditional M1.

HV (%) values are calculated for All Movement Classes of All Heavy Vehicle Model Designation.

SIDRA INTERSECTION 8.0 | Copyright © 2000-2019 Akcelik and Associates Pty Ltd | sidrasolutions.com

Organisation: FEHR AND PEERS | Processed: Saturday, July 23, 2022 11:31:23 AM

Project: C:\Users\syamagata\Desktop\Projects\Snow Park Village\July 2022 TIS Update\SIDRA\DeerValleyDrRoundabout.sip8



Intersection 1		Deer Valley Drive East/Doe Pass Road			Signal		
Direction	Movement	Demand Volume (vph)	Served Volume (vph)		Total Delay (sec/veh)		LOS
			Average	Percent	Average	Std. Dev.	
NB	Left Turn	278	277	99.7%	1.4	0.7	A
	Through						
	Right Turn						
	Subtotal	278	277	99.7%	1.4	0.7	A
SB	Left Turn	388	398	102.5%	2.3	0.5	A
	Through						
	Right Turn						
	Subtotal	403	416	103.1%	2.3	0.5	A
EB	Left Turn	31	32	101.6%	7.9	1.1	A
	Through						
	Right Turn						
	Subtotal	31	32	101.6%	7.9	1.1	A
WB	Left Turn						
	Through						
	Right Turn						
	Subtotal						
Total		712	724	101.7%	2.2	0.6	A

Intersection 2		Deer Valley Drive West/Doe Pass Road			Side-street Stop		
Direction	Movement	Demand Volume (vph)	Served Volume (vph)		Total Delay (sec/veh)		LOS
			Average	Percent	Average	Std. Dev.	
NB	Left Turn	20	21	105.0%	7.7	1.8	A
	Through						
	Right Turn						
	Subtotal	20	21	105.0%	7.7	1.8	A
SB	Left Turn						
	Through						
	Right Turn						
	Subtotal						
EB	Left Turn	576	581	100.8%	2.5	0.2	A
	Through						
	Right Turn						
	Subtotal	596	603	101.1%	2.5	0.2	A
WB	Left Turn	30	35	116.3%	1.0	0.4	A
	Through						
	Right Turn						
	Subtotal	30	35	116.3%	1.0	0.4	A
Total		646	659	102.0%	2.6	0.2	A

**Intersection 3**                      **Deer Valley Drive East/Queen Esther Drive**                      **Side-street Stop**

Direction	Movement	Demand Volume (vph)	Served Volume (vph)		Total Delay (sec/veh)		
			Average	Percent	Average	Std. Dev.	LOS
NB	Left Turn						
	Through	334	338	101.3%	0.8	0.1	A
	Right Turn	20	21	104.5%	0.4	0.4	A
	Subtotal	354	359	101.4%	0.8	0.1	A
SB	Left Turn	50	48	96.0%	5.0	0.7	A
	Through	397	406	102.2%	1.5	0.2	A
	Right Turn						
	Subtotal	447	454	101.5%	1.9	0.3	A
EB	Left Turn						
	Through						
	Right Turn						
	Subtotal						
WB	Left Turn	20	22	109.0%	12.6	4.2	B
	Through						
	Right Turn	55	56	101.3%	6.7	1.2	A
	Subtotal	75	78	103.3%	8.5	2.0	A
<b>Total</b>		<b>876</b>	<b>890</b>	<b>101.6%</b>	<b>2.0</b>	<b>0.2</b>	<b>A</b>

**Intersection 4**                      **Solamere Drive/Deer Valley Drive East**                      **Side-street Stop**

Direction	Movement	Demand Volume (vph)	Served Volume (vph)		Total Delay (sec/veh)		
			Average	Percent	Average	Std. Dev.	LOS
NB	Left Turn						
	Through						
	Right Turn						
	Subtotal						
SB	Left Turn	25	22	88.8%	15.4	6.6	C
	Through						
	Right Turn	60	63	105.5%	9.0	3.8	A
	Subtotal	85	86	100.6%	10.7	4.4	B
EB	Left Turn	50	49	97.2%	5.7	1.2	A
	Through	422	430	101.9%	2.5	0.4	A
	Right Turn						
	Subtotal	472	479	101.4%	2.9	0.5	A
WB	Left Turn						
	Through	369	374	101.2%	1.1	0.1	A
	Right Turn	20	20	99.5%	1.0	1.1	A
	Subtotal	389	394	101.2%	1.1	0.1	A
<b>Total</b>		<b>946</b>	<b>958</b>	<b>101.2%</b>	<b>3.0</b>	<b>0.8</b>	<b>A</b>

**Intersection 5**                      **Deer Valley Drive West/Deer Valley Drive East**                      **Side-street Stop**

Direction	Movement	Demand Volume (vph)	Served Volume (vph)		Total Delay (sec/veh)		
			Average	Percent	Average	Std. Dev.	LOS
NB	Left Turn						
	Through	35	36	102.9%	9.4	3.3	A
	Right Turn	15	18	116.7%	7.7	4.7	A
	Subtotal	50	54	107.0%	9.0	3.1	A
SB	Left Turn	457	460	100.7%	1.4	0.1	A
	Through	586	589	100.6%	1.1	0.1	A
	Right Turn						
	Subtotal	1,043	1,050	100.6%	1.2	0.1	A
EB	Left Turn						
	Through						
	Right Turn						
	Subtotal						
WB	Left Turn	10	9	86.0%	17.5	15.4	C
	Through						
	Right Turn	419	426	101.7%	3.6	0.8	A
	Subtotal	429	435	101.4%	3.9	1.1	A
<b>Total</b>		<b>1,522</b>	<b>1,538</b>	<b>101.0%</b>	<b>2.3</b>	<b>0.4</b>	<b>A</b>

**Intersection 7**                      **Deer Valley Drive/Bonanza Drive**                      **Signal**

Direction	Movement	Demand Volume (vph)	Served Volume (vph)		Total Delay (sec/veh)		
			Average	Percent	Average	Std. Dev.	LOS
NB	Left Turn						
	Through	314	314	99.8%	47.6	34.4	D
	Right Turn	216	217	100.4%	6.7	9.4	A
	Subtotal	530	530	100.1%	31.2	24.0	C
SB	Left Turn	125	100	79.6%	14.1	1.5	B
	Through	697	602	86.3%	10.0	1.4	B
	Right Turn						
	Subtotal	822	701	85.3%	10.6	1.1	B
EB	Left Turn						
	Through						
	Right Turn						
	Subtotal						
WB	Left Turn	717	723	100.8%	30.9	12.9	C
	Through						
	Right Turn	225	222	98.5%	23.2	14.4	C
	Subtotal	942	945	100.3%	29.1	12.5	C
<b>Total</b>		<b>2,294</b>	<b>2,176</b>	<b>94.9%</b>	<b>23.8</b>	<b>11.1</b>	<b>C</b>

**Intersection 8**                      **SR-224-Park Avenue/Empire Avenue-Deer Valley Drive**                      **Signal**

Direction	Movement	Demand Volume (vph)	Served Volume (vph)		Total Delay (sec/veh)		
			Average	Percent	Average	Std. Dev.	LOS
NB	Left Turn	95	90	94.7%	34.2	4.1	C
	Through	195	203	103.8%	48.7	8.9	D
	Right Turn	70	74	105.3%	19.8	8.2	B
	Subtotal	360	366	101.7%	39.8	6.8	D
SB	Left Turn	522	338	64.7%	91.0	22.5	F
	Through	170	108	63.7%	76.3	9.7	E
	Right Turn	1,565	1,015	64.8%	122.7	4.1	F
	Subtotal	2,257	1,460	64.7%	112.9	5.2	F
EB	Left Turn	580	531	91.5%	72.1	4.2	E
	Through	360	341	94.6%	48.7	9.2	D
	Right Turn	45	43	95.3%	38.7	10.8	D
	Subtotal	985	914	92.8%	62.0	5.5	E
WB	Left Turn	50	41	82.6%	111.1	20.8	F
	Through	425	403	94.9%	101.3	9.8	F
	Right Turn	254	235	92.6%	16.6	5.0	B
	Subtotal	729	680	93.3%	72.7	8.6	E
<b>Total</b>		<b>4,331</b>	<b>3,421</b>	<b>79.0%</b>	<b>83.0</b>	<b>3.6</b>	<b>F</b>

**Intersection 9**                      **Monitor Drive-Bonanza Drive/SR-248**                      **Signal**

Direction	Movement	Demand Volume (vph)	Served Volume (vph)		Total Delay (sec/veh)		
			Average	Percent	Average	Std. Dev.	LOS
NB	Left Turn	75	70	93.9%	24.1	4.3	C
	Through	30	31	101.7%	30.5	5.1	C
	Right Turn	136	123	90.1%	3.8	1.0	A
	Subtotal	241	224	92.7%	13.9	3.0	B
SB	Left Turn	65	61	93.7%	22.1	6.1	C
	Through	75	78	104.3%	31.4	4.3	C
	Right Turn	35	37	105.1%	4.8	0.7	A
	Subtotal	175	176	100.5%	22.7	3.8	C
EB	Left Turn	25	25	101.2%	12.4	4.0	B
	Through	340	326	95.9%	20.7	3.4	C
	Right Turn	110	114	103.7%	12.9	2.2	B
	Subtotal	475	466	98.0%	18.4	2.8	B
WB	Left Turn	362	363	100.4%	16.8	1.9	B
	Through	475	476	100.1%	9.1	1.3	A
	Right Turn	55	56	101.6%	4.7	1.8	A
	Subtotal	892	895	100.3%	12.1	1.1	B
<b>Total</b>		<b>1,783</b>	<b>1,760</b>	<b>98.7%</b>	<b>15.1</b>	<b>1.5</b>	<b>B</b>

**Intersection 1**                      **Deer Valley Drive East/Doe Pass Road**                      **Signal**

Direction	Movement	Demand Volume (vph)	Served Volume (vph)		Total Delay (sec/veh)		LOS
			Average	Percent	Average	Std. Dev.	
NB	Left Turn	1,050	1,048	99.8%	4.1	1.7	A
	Through						
	Right Turn						
	Subtotal	1,050	1,048	99.8%	4.1	1.7	A
SB	Left Turn	240	254	105.8%	1.7	0.7	A
	Through						
	Right Turn						
	Subtotal	255	272	106.6%	1.6	0.6	A
EB	Left Turn	26	26	98.5%	8.2	1.9	A
	Through						
	Right Turn						
	Subtotal	26	26	98.5%	8.2	1.9	A
WB	Left Turn						
	Through						
	Right Turn						
	Subtotal						
<b>Total</b>		<b>1,331</b>	<b>1,345</b>	<b>101.1%</b>	<b>3.7</b>	<b>1.4</b>	<b>A</b>

**Intersection 2**                      **Deer Valley Drive West/Doe Pass Road**                      **Side-street Stop**

Direction	Movement	Demand Volume (vph)	Served Volume (vph)		Total Delay (sec/veh)		LOS
			Average	Percent	Average	Std. Dev.	
NB	Left Turn	20	21	104.5%	6.0	0.9	A
	Through						
	Right Turn						
	Subtotal	20	21	104.5%	6.0	0.9	A
SB	Left Turn						
	Through						
	Right Turn						
	Subtotal						
EB	Left Turn	204	206	100.8%	1.3	0.3	A
	Through						
	Right Turn						
	Subtotal	224	224	100.1%	1.3	0.2	A
WB	Left Turn	60	63	104.7%	1.3	0.3	A
	Through						
	Right Turn						
	Subtotal	60	63	104.7%	1.3	0.3	A
<b>Total</b>		<b>304</b>	<b>308</b>	<b>101.3%</b>	<b>1.5</b>	<b>0.2</b>	<b>A</b>

**Intersection 3**                      **Deer Valley Drive East/Queen Esther Drive**                      **Side-street Stop**

Direction	Movement	Demand Volume (vph)	Served Volume (vph)		Total Delay (sec/veh)		
			Average	Percent	Average	Std. Dev.	LOS
NB	Left Turn						
	Through	1,080	1,094	101.3%	3.3	2.3	A
	Right Turn	30	27	91.0%	3.8	5.3	A
	Subtotal	1,110	1,121	101.0%	3.3	2.3	A
SB	Left Turn	85	84	99.2%	15.1	6.5	C
	Through	275	292	106.2%	7.3	4.0	A
	Right Turn						
	Subtotal	360	376	104.6%	9.0	4.5	A
EB	Left Turn						
	Through						
	Right Turn						
	Subtotal						
WB	Left Turn	30	32	105.0%	53.6	47.2	F
	Through						
	Right Turn	60	57	95.7%	40.7	43.4	E
	Subtotal	90	89	98.8%	45.4	44.1	E
Total		1,560	1,586	101.7%	7.4	5.2	A

**Intersection 4**                      **Solamere Drive/Deer Valley Drive East**                      **Side-street Stop**

Direction	Movement	Demand Volume (vph)	Served Volume (vph)		Total Delay (sec/veh)		
			Average	Percent	Average	Std. Dev.	LOS
NB	Left Turn						
	Through						
	Right Turn						
	Subtotal						
SB	Left Turn	20	18	88.0%	155.3	192.8	F
	Through						
	Right Turn	80	76	94.9%	140.8	202.3	F
	Subtotal	100	94	93.5%	147.2	203.0	F
EB	Left Turn	90	88	97.7%	50.4	67.3	F
	Through	340	354	104.0%	34.9	55.3	D
	Right Turn						
	Subtotal	430	441	102.7%	38.2	58.2	E
WB	Left Turn						
	Through	1,105	1,116	101.0%	5.6	8.3	A
	Right Turn	35	34	96.0%	6.1	9.2	A
	Subtotal	1,140	1,149	100.8%	5.7	8.3	A
Total		1,670	1,684	100.9%	19.5	25.3	C

**Intersection 5**                      **Deer Valley Drive West/Deer Valley Drive East**                      **Side-street Stop**

Direction	Movement	Demand Volume (vph)	Served Volume (vph)		Total Delay (sec/veh)		
			Average	Percent	Average	Std. Dev.	LOS
NB	Left Turn						
	Through	35	35	99.4%	9.2	1.5	A
	Right Turn	45	50	110.0%	6.0	1.4	A
	Subtotal	80	84	105.4%	7.3	1.0	A
SB	Left Turn	385	391	101.6%	1.0	0.2	A
	Through	199	195	97.9%	0.6	0.1	A
	Right Turn						
	Subtotal	584	586	100.3%	0.8	0.1	A
EB	Left Turn						
	Through						
	Right Turn						
	Subtotal						
WB	Left Turn	25	26	105.2%	30.5	6.6	D
	Through						
	Right Turn	1,160	1,166	100.5%	26.0	6.3	D
	Subtotal	1,185	1,192	100.6%	26.2	6.3	D
<b>Total</b>		<b>1,849</b>	<b>1,862</b>	<b>100.7%</b>	<b>17.4</b>	<b>4.1</b>	<b>C</b>

**Intersection 7**                      **Deer Valley Drive/Bonanza Drive**                      **Signal**

Direction	Movement	Demand Volume (vph)	Served Volume (vph)		Total Delay (sec/veh)		
			Average	Percent	Average	Std. Dev.	LOS
NB	Left Turn						
	Through	835	803	96.1%	120.8	54.3	F
	Right Turn	840	801	95.4%	154.4	86.4	F
	Subtotal	1,675	1,604	95.8%	138.4	71.2	F
SB	Left Turn	290	183	63.2%	22.6	3.4	C
	Through	522	364	69.8%	7.7	1.4	A
	Right Turn						
	Subtotal	812	548	67.5%	12.8	1.6	B
EB	Left Turn						
	Through						
	Right Turn						
	Subtotal						
WB	Left Turn	551	548	99.4%	35.6	9.0	D
	Through						
	Right Turn	150	151	100.5%	21.6	7.9	C
	Subtotal	701	698	99.6%	32.6	8.8	C
<b>Total</b>		<b>3,188</b>	<b>2,850</b>	<b>89.4%</b>	<b>87.2</b>	<b>38.4</b>	<b>F</b>



**Intersection 8 SR-224-Park Avenue/Empire Avenue-Deer Valley Drive Signal**

Direction	Movement	Demand Volume (vph)	Served Volume (vph)		Total Delay (sec/veh)		
			Average	Percent	Average	Std. Dev.	LOS
NB	Left Turn	70	68	96.9%	32.6	6.2	C
	Through	395	396	100.1%	53.7	4.5	D
	Right Turn	70	71	101.1%	32.7	8.6	C
	Subtotal	535	534	99.8%	48.2	4.6	D
SB	Left Turn	547	367	67.1%	217.6	9.0	F
	Through	365	246	67.4%	174.5	10.1	F
	Right Turn	720	491	68.1%	54.8	8.9	D
	Subtotal	1,632	1,104	67.6%	135.3	6.3	F
EB	Left Turn	1,190	513	43.1%	90.8	6.7	F
	Through	445	194	43.7%	76.8	14.1	E
	Right Turn	70	28	40.4%	67.9	29.9	E
	Subtotal	1,705	736	43.1%	86.4	8.2	F
WB	Left Turn	75	59	78.0%	118.7	16.3	F
	Through	405	400	98.8%	97.7	2.2	F
	Right Turn	690	577	83.6%	39.8	4.9	D
	Subtotal	1,170	1,036	88.5%	65.9	2.4	E
Total		5,042	3,409	67.6%	89.9	2.1	F

**Intersection 9 Monitor Drive-Bonanza Drive/SR-248 Signal**

Direction	Movement	Demand Volume (vph)	Served Volume (vph)		Total Delay (sec/veh)		
			Average	Percent	Average	Std. Dev.	LOS
NB	Left Turn	210	186	88.4%	61.8	31.1	E
	Through	90	90	100.2%	39.2	7.2	D
	Right Turn	585	516	88.2%	20.6	8.9	C
	Subtotal	885	792	89.5%	33.4	13.7	C
SB	Left Turn	105	104	98.9%	43.8	9.4	D
	Through	55	54	97.8%	38.7	6.7	D
	Right Turn	75	75	99.3%	6.6	1.0	A
	Subtotal	235	232	98.8%	30.2	4.5	C
EB	Left Turn	85	87	102.7%	23.9	6.7	C
	Through	865	869	100.4%	42.2	10.9	D
	Right Turn	175	181	103.3%	40.8	13.5	D
	Subtotal	1,125	1,137	101.0%	40.4	10.9	D
WB	Left Turn	276	273	98.8%	25.9	4.5	C
	Through	570	570	100.1%	13.7	2.5	B
	Right Turn	55	52	94.5%	9.9	3.8	A
	Subtotal	901	895	99.3%	17.2	2.6	B
Total		3,146	3,056	97.1%	30.9	6.1	C

Project: UT20-2245  
 Description: Snow Park Transportation Study

Park City Minimum Parking Rates Based Nonshared Parking Demand Summary																
Land Use	Project Data		Weekday				Weekend				Weekend					
	Quantity	Unit	Base Ratio	Driving Adj	Non-Captive Ratio	Project Ratio	Unit For Ratio	Base Ratio	Driving Adj	Non-Captive Ratio	Project Ratio	Unit For Ratio	Peak Hr Adj 6 AM	Peak Mo Adj December		
															Estimated Parking Demand	Estimated Parking Demand
Retail																
Retail (<400 ksf) Employee	25,866	sf GLA	3.22	100%	100%	3.22	ksf GLA	3.20	100%	100%	3.20	ksf GLA	100%	100%	84	83
			0.78	100%	100%	0.78		0.80	100%	100%	0.80		100%	100%	21	21
Food and Beverage																
Convention Center Employee	30,879	sf GLA	5.73	100%	100%	5.73	ksf GLA	5.73	100%	100%	5.73	ksf GLA	100%	100%	177	177
			0.52	100%	100%	0.52		0.52	100%	100%	0.52		100%	100%	17	17
Hotel and Residential																
Hotel-Business		keys	0.87	100%	100%	0.87	key	0.87	100%	100%	0.87	key	100%	100%	-	-
Hotel-Leisure	193	keys	0.87	100%	100%	0.87	key	0.87	100%	100%	0.87	key	100%	100%	168	168
Hotel Employees	193	keys	0.13	100%	100%	0.13	key	0.13	100%	100%	0.13	key	100%	100%	25	25
Restaurant/Lounge	5,451	sf GLA	4.24	100%	100%	4.24	ksf GLA	4.26	100%	100%	4.26	ksf GLA	100%	100%	24	24
Meeting/Banquet (0 to 20 sq ft/ke)		sf GLA	0.00	100%	100%	0.00	ksf GLA	0.00	100%	100%	0.00	ksf GLA	100%	100%	-	-
Meeting/Banquet (20 to 50 sq ft/ke)		sf GLA	0.00	100%	100%	0.00	ksf GLA	0.00	100%	100%	0.00	ksf GLA	100%	100%	-	-
Meeting/Banquet (50 to 100 sq ft/ke)		sf GLA	0.00	100%	100%	0.00	ksf GLA	0.00	100%	100%	0.00	ksf GLA	100%	100%	-	-
Convention (100 to 200 sq ft/ke)		sf GLA	0.00	100%	100%	0.00	ksf GLA	5.50	100%	100%	5.50	ksf GLA	100%	100%	-	-
Convention (> 200 sq ft/ke)		sf GLA	4.58	100%	100%	4.58	ksf GLA	4.58	100%	100%	4.58	ksf GLA	100%	100%	-	-
Restaurant/Meeting Employees	5,451	sf GLA	0.76	100%	100%	0.76	ksf GLA	0.74	100%	100%	0.74	ksf GLA	100%	100%	5	5
Office																
Residential, Urban		units	0.00	100%	100%	0.00	unit	0.00	100%	100%	0.00	unit	100%	100%	0%	0%
Studio Efficiency		units	0.00	100%	100%	0.00	unit	0.00	100%	100%	0.00	unit	100%	100%	-	-
1 Bedroom	11	units	0.00	100%	100%	0.00	unit	0.00	100%	100%	0.00	unit	100%	100%	-	-
2 Bedrooms		units	0.00	100%	100%	0.00	unit	0.00	100%	100%	0.00	unit	100%	100%	-	-
3+ Bedrooms	132	units	0.00	100%	100%	0.00	unit	0.00	100%	100%	0.00	unit	100%	100%	-	-
Reserved	100%	res spaces	1.44	100%	100%	1.44	unit	1.41	100%	100%	1.41	unit	100%	100%	206	201
Visitor	143	units	0.06	100%	100%	0.06	unit	0.08	100%	100%	0.08	unit	100%	100%	9	13
Additional Land Uses																
Ski Resort (as observed during data collection) Employee	1	count	1,500	100%	100%	1,500	count	1,500	100%	100%	1,500	count	100%	100%	1,500	1,500
			0.00	100%	100%	0.00		0.00	100%	100%	0.00		100%	100%	-	-
													Customer	Employee/Resident	1,962	68
													Reserved	Reserved	206	201
													Total	Total	2,236	2,234

Project: UT20-2245  
 Description: Snow Park Transportation Study

Park City Minimum Parking Rates Based Shared Parking Demand Summary																		
Land Use	Project Data		Weekday				Weekend				Weekday			Weekend				
	Quantity	Unit	Base Ratio	Driving Adj	Non-Captive Ratio	Project Ratio	Unit For Ratio	Base Ratio	Driving Adj	Non-Captive Ratio	Project Ratio	Unit For Ratio	Peak Hr Adj 1 PM	Peak Mo Adj December	Estimated Parking Demand	Peak Hr Adj 12 PM	Peak Mo Adj December	Estimated Parking Demand
Retail (<400 ksf) Employee	25,866	sf GLA	3.22	100%	97%	3.11	ksf GLA	3.20	100%	97%	3.09	ksf GLA	100%	100%	81	100%	100%	80
			0.78	100%	100%	0.78		0.80	100%	100%	0.80		100%	100%	21	100%	100%	21
Retail																		
Convention Center Employee	30,879	sf GLA	5.73	100%	87%	4.97	ksf GLA	5.73	100%	87%	4.97	ksf GLA	100%	100%	153	100%	100%	153
			0.52	100%	100%	0.52		0.52	100%	100%	0.52		100%	100%	17	100%	100%	17
Food and Beverage																		
Hotel-Business		keys	0.87	49%	100%	0.42	key	0.87	53%	100%	0.46	key	55%	60%	-	55%	60%	-
Hotel-Leisure	193	keys	0.87	50%	100%	0.43	key	0.87	50%	100%	0.43	key	65%	50%	27	65%	50%	27
Hotel Employees	193	keys	0.13	100%	100%	0.13	key	0.13	100%	100%	0.13	key	100%	50%	13	100%	50%	13
Restaurant/Lounge	5,451	sf GLA	4.24	72%	90%	2.75	ksf GLA	4.26	72%	70%	2.15	ksf GLA	100%	100%	16	100%	100%	12
Meeting/Banquet (0 to 20 sq ft/ke)		sf GLA	0.00	81%	90%	0.00	ksf GLA	0.00	36%	90%	0.00	ksf GLA	65%	100%	-	65%	100%	-
Meeting/Banquet (20 to 50 sq ft/ke)		sf GLA	0.00	81%	90%	0.00	ksf GLA	0.00	36%	90%	0.00	ksf GLA	65%	100%	-	65%	100%	-
Meeting/Banquet (50 to 100 sq ft/ke)		sf GLA	0.00	81%	90%	0.00	ksf GLA	0.00	36%	90%	0.00	ksf GLA	65%	100%	-	65%	100%	-
Convention (100 to 200 sq ft/ke)		sf GLA	0.00	81%	90%	0.00	ksf GLA	5.50	36%	90%	1.78	ksf GLA	100%	100%	-	100%	100%	-
Convention (> 200 sq ft/ke)		sf GLA	4.58	81%	90%	3.34	ksf GLA	4.58	36%	90%	1.49	ksf GLA	100%	100%	-	100%	100%	-
Restaurant/Meeting Employees	5,451	sf GLA	0.76	100%	100%	0.76	ksf GLA	0.74	100%	100%	0.74	ksf GLA	100%	100%	5	100%	100%	5
Office																		
Residential, Urban		units	0.00	100%	100%	0.00	unit	0.00	100%	100%	0.00	unit	0%	0%	-	0%	0%	-
Studio Efficiency		units	0.00	100%	100%	0.00	unit	0.00	100%	100%	0.00	unit	50%	100%	-	68%	100%	-
1 Bedroom	11	units	0.00	100%	100%	0.00	unit	0.00	100%	100%	0.00	unit	50%	100%	-	68%	100%	-
2 Bedrooms		units	0.00	100%	100%	0.00	unit	0.00	100%	100%	0.00	unit	50%	100%	-	68%	100%	-
3+ Bedrooms	132	units	0.00	100%	100%	0.00	unit	0.00	100%	100%	0.00	unit	50%	100%	-	68%	100%	-
Reserved	100%	res spaces	1.44	100%	100%	1.44	unit	1.41	100%	100%	1.41	unit	100%	100%	206	100%	100%	201
Visitor	143	units	0.06	100%	100%	0.06	unit	0.08	100%	100%	0.08	unit	20%	100%	2	20%	100%	3
Additional Land Uses																		
Ski Resort (as observed during data collection) Employee	1	count	1,500	100%	100%	1,500	count	1,500	100%	100%	1,500	count	100%	100%	1,500	100%	100%	1,500
			0.00	100%	100%	0.00		0.00	100%	100%	0.00		100%	100%	-	100%	100%	-
													Customer/Visitor	Employee/Resident	Customer	Employee/Resident	Reserved	Total
													1,779	56	1,776	201	56	1,776
													206	206	206	201	201	2,032
													Total	Total	Total	Total	Total	Total

Shared Parking Reduction 9%

9%

Vissim Post-Processor  
Average Results from 10 Runs  
Volume and Delay by Movement

Snow Park Village  
2040 Plus Project - Circulation Analysis  
AM Peak Hour

Intersection 1		Deer Valley Drive East/Doe Pass Road			Signal		
Direction	Movement	Demand Volume (vph)	Served Volume (vph)		Total Delay (sec/veh)		LOS
			Average	Percent	Average	Std. Dev.	
NB	Left Turn						
	Through	278	278	100.0%	5.2	1.3	A
	Right Turn						
	Subtotal	278	278	100.0%	5.2	1.3	A
SB	Left Turn						
	Through	388	394	101.5%	6.5	1.7	A
	Right Turn	15	15	100.0%	2.9	0.1	A
	Subtotal	403	409	101.5%	6.4	1.6	A
EB	Left Turn	31	30	97.1%	6.1	2.9	A
	Through						
	Right Turn	100	99	98.9%	5.5	0.8	A
	Subtotal	131	129	98.5%	5.6	0.9	A
WB	Left Turn						
	Through						
	Right Turn						
	Subtotal						
Total		812	816	100.5%	5.8	0.6	A

Intersection 2		Deer Valley Drive West/Doe Pass Road			Side-street Stop		
Direction	Movement	Demand Volume (vph)	Served Volume (vph)		Total Delay (sec/veh)		LOS
			Average	Percent	Average	Std. Dev.	
NB	Left Turn	20	18	89.5%	9.9	1.9	A
	Through						
	Right Turn						
	Subtotal	20	18	89.5%	9.9	1.9	A
SB	Left Turn						
	Through						
	Right Turn						
	Subtotal						
EB	Left Turn						
	Through	576	575	99.8%	13.5	12.0	B
	Right Turn	20	20	100.5%	11.3	16.6	B
	Subtotal	596	595	99.9%	13.5	12.1	B
WB	Left Turn						
	Through	30	27	90.3%	0.5	0.1	A
	Right Turn						
	Subtotal	30	27	90.3%	0.5	0.1	A
Total		646	640	99.1%	12.9	11.4	B

**Intersection 3**                      **Deer Valley Drive East/Queen Esther Drive**                      **Side-street Stop**

Direction	Movement	Demand Volume (vph)	Served Volume (vph)		Total Delay (sec/veh)		
			Average	Percent	Average	Std. Dev.	LOS
NB	Left Turn						
	Through	334	322	96.4%	3.9	0.8	A
	Right Turn	20	27	137.0%	1.6	1.0	A
	Subtotal	354	349	98.7%	3.7	0.7	A
SB	Left Turn	50	48	96.6%	5.6	2.6	A
	Through	397	404	101.7%	4.7	0.7	A
	Right Turn						
	Subtotal	447	452	101.1%	4.8	0.7	A
EB	Left Turn						
	Through						
	Right Turn						
	Subtotal						
WB	Left Turn	20	20	98.0%	9.7	2.8	A
	Through						
	Right Turn	55	55	100.4%	7.1	1.2	A
	Subtotal	75	75	99.7%	7.7	1.4	A
Total		876	876	100.0%	4.7	0.5	A

**Intersection 4**                      **Solamere Drive/Deer Valley Drive East**                      **Side-street Stop**

Direction	Movement	Demand Volume (vph)	Served Volume (vph)		Total Delay (sec/veh)		
			Average	Percent	Average	Std. Dev.	LOS
NB	Left Turn						
	Through						
	Right Turn						
	Subtotal						
SB	Left Turn	25	27	108.4%	9.7	1.8	A
	Through						
	Right Turn	60	58	96.2%	6.4	0.5	A
	Subtotal	85	85	99.8%	7.5	0.7	A
EB	Left Turn	50	49	97.2%	9.4	2.7	A
	Through	422	426	101.0%	12.7	1.9	B
	Right Turn						
	Subtotal	472	475	100.6%	12.4	1.9	B
WB	Left Turn						
	Through	369	349	94.7%	2.9	0.4	A
	Right Turn	20	28	138.0%	1.4	0.5	A
	Subtotal	389	377	96.9%	2.7	0.4	A
Total		946	937	99.0%	8.3	1.0	A

**Intersection 5**                      **Deer Valley Drive West/Deer Valley Drive East**                      **Side-street Stop**

Direction	Movement	Demand Volume (vph)	Served Volume (vph)		Total Delay (sec/veh)		
			Average	Percent	Average	Std. Dev.	LOS
NB	Left Turn						
	Through	35	32	90.9%	25.5	6.9	D
	Right Turn	15	13	88.0%	12.9	5.8	B
	Subtotal	50	45	90.0%	22.0	5.5	C
SB	Left Turn	457	458	100.2%	15.2	1.3	C
	Through	586	584	99.7%	9.2	0.9	A
	Right Turn						
	Subtotal	1,043	1,042	99.9%	11.9	0.7	B
EB	Left Turn						
	Through						
	Right Turn						
	Subtotal						
WB	Left Turn	10	9	94.0%	13.0	4.7	B
	Through						
	Right Turn	419	393	93.8%	10.7	1.5	B
	Subtotal	429	402	93.8%	10.8	1.5	B
Total		1,522	1,489	97.9%	11.9	0.8	B

**Intersection 6**                      **P2 Parking/Doe Pass Road**                      **Side-street Stop**

Direction	Movement	Demand Volume (vph)	Served Volume (vph)		Total Delay (sec/veh)		
			Average	Percent	Average	Std. Dev.	LOS
NB	Left Turn	15	13	87.3%	11.0	4.7	B
	Through						
	Right Turn						
	Subtotal	15	13	87.3%	11.0	4.7	B
SB	Left Turn						
	Through						
	Right Turn						
	Subtotal						
EB	Left Turn						
	Through	140	139	99.5%	7.5	3.0	A
	Right Turn	436	438	100.4%	13.2	4.6	B
	Subtotal	576	577	100.2%	11.9	4.2	B
WB	Left Turn						
	Through	15	14	93.3%	0.0	0.1	A
	Right Turn						
	Subtotal	15	14	93.3%	0.0	0.1	A
Total		606	604	99.7%	11.6	4.1	B

**Intersection 7**                      **P1 Parking/Doe Pass Road**                      **Side-street Stop**

Direction	Movement	Demand Volume (vph)	Served Volume (vph)		Total Delay (sec/veh)		
			Average	Percent	Average	Std. Dev.	LOS
NB	Left Turn						
	Through						
	Right Turn	16	15	93.1%	6.8	1.4	A
	Subtotal	16	15	93.1%	6.8	1.4	A
SB	Left Turn						
	Through						
	Right Turn						
	Subtotal						
EB	Left Turn						
	Through	115	114	99.0%	0.2	0.1	A
	Right Turn	25	25	101.6%	0.5	0.5	A
	Subtotal	140	139	99.5%	0.3	0.2	A
WB	Left Turn						
	Through	15	14	94.7%	0.0	0.0	A
	Right Turn						
	Subtotal	15	14	94.7%	0.0	0.0	A
Total		171	168	98.5%	1.1	0.2	A

**Intersection 8**                      **Mobility Hub Entrance/Doe Pass Road**                      **Side-street Stop**

Direction	Movement	Demand Volume (vph)	Served Volume (vph)		Total Delay (sec/veh)		
			Average	Percent	Average	Std. Dev.	LOS
NB	Left Turn						
	Through						
	Right Turn						
	Subtotal						
SB	Left Turn						
	Through						
	Right Turn						
	Subtotal						
EB	Left Turn						
	Through	116	114	98.1%	0.1	0.0	A
	Right Turn	15	12	80.7%	0.0	0.0	A
	Subtotal	131	126	96.1%	0.0	0.0	A
WB	Left Turn	15	13	86.7%	1.5	1.6	A
	Through	15	14	94.7%	0.0	0.0	A
	Right Turn						
	Subtotal	30	27	90.7%	0.7	0.8	A
Total		161	153	95.1%	0.2	0.1	A



**Intersection 9**                      **Mobility Hub Exit/Doe Pass Road**                      **Side-street Stop**

Direction	Movement	Demand Volume (vph)	Served Volume (vph)		Total Delay (sec/veh)		
			Average	Percent	Average	Std. Dev.	LOS
NB	Left Turn	15	14	95.3%	22.9	2.8	C
	Through						
	Right Turn	15	15	100.7%	9.3	1.6	A
	Subtotal	30	29	98.0%	15.8	2.0	C
SB	Left Turn						
	Through						
	Right Turn						
	Subtotal						
EB	Left Turn						
	Through	116	114	98.1%	1.5	0.8	A
	Right Turn						
	Subtotal	116	114	98.1%	1.5	0.8	A
WB	Left Turn						
	Through	15	15	100.0%	0.2	0.1	A
	Right Turn						
	Subtotal	15	15	100.0%	0.2	0.1	A
Total		161	158	98.3%	4.2	0.6	A

**Intersection 10**                      **Deer Valley Drive East/P2 Parking**                      **Side-street Stop**

Direction	Movement	Demand Volume (vph)	Served Volume (vph)		Total Delay (sec/veh)		
			Average	Percent	Average	Std. Dev.	LOS
NB	Left Turn						
	Through	242	244	100.9%	0.6	0.2	A
	Right Turn						
	Subtotal	242	244	100.9%	0.6	0.2	A
SB	Left Turn						
	Through	343	348	101.3%	1.7	0.4	A
	Right Turn	145	146	100.7%	1.3	0.4	A
	Subtotal	488	494	101.1%	1.6	0.4	A
EB	Left Turn	36	34	93.6%	9.9	1.9	A
	Through						
	Right Turn						
	Subtotal	36	34	93.6%	9.9	1.9	A
WB	Left Turn						
	Through						
	Right Turn						
	Subtotal						
Total		766	771	100.7%	1.6	0.3	A

**Intersection 11**                      **Deer Valley Drive East/P3 Parking**                      **Side-street Stop**

Direction	Movement	Demand Volume (vph)	Served Volume (vph)		Total Delay (sec/veh)		
			Average	Percent	Average	Std. Dev.	LOS
NB	Left Turn	207	210	101.4%	2.5	0.6	A
	Through						
	Right Turn						
	Subtotal	207	210	101.4%	2.5	0.6	A
SB	Left Turn	243	250	102.7%	3.4	1.2	A
	Through						
	Right Turn						
	Subtotal	343	347	101.3%	3.0	1.1	A
EB	Left Turn	35	34	96.6%	13.1	1.9	B
	Through						
	Right Turn						
	Subtotal	35	34	96.6%	13.1	1.9	B
WB	Left Turn						
	Through						
	Right Turn						
	Subtotal						
Total		585	591	101.0%	3.5	0.7	A

**Intersection 12**                      **Deer Valley Drive East/P4 Parking**                      **Side-street Stop**

Direction	Movement	Demand Volume (vph)	Served Volume (vph)		Total Delay (sec/veh)		
			Average	Percent	Average	Std. Dev.	LOS
NB	Left Turn	50	48	95.8%	2.0	1.0	A
	Through						
	Right Turn						
	Subtotal	200	202	101.1%	2.3	0.5	A
SB	Left Turn	200	202	101.2%	1.2	0.3	A
	Through						
	Right Turn						
	Subtotal	243	250	102.9%	1.2	0.2	A
EB	Left Turn	57	56	97.4%	17.2	0.9	C
	Through						
	Right Turn						
	Subtotal	57	56	97.4%	17.2	0.9	C
WB	Left Turn						
	Through						
	Right Turn						
	Subtotal						
Total		500	508	101.6%	3.3	0.3	A

Vissim Post-Processor  
Average Results from 10 Runs  
Volume and Delay by Movement

Snow Park Village  
2040 Plus Project - Circulation Analysis  
AM Peak Hour

Intersection 13                      Deer Valley Drive East/Pick-up/Drop-off                      Uncontrolled

Direction	Movement	Demand Volume (vph)	Served Volume (vph)		Total Delay (sec/veh)		
			Average	Percent	Average	Std. Dev.	LOS
NB	Left Turn	200	202	101.2%	13.7	6.0	B
	Through						
	Right Turn						
	Subtotal						
SB	Left Turn	200	202	101.2%	1.8	0.4	A
	Through						
	Right Turn						
	Subtotal						
EB	Left Turn						
	Through						
	Right Turn						
	Subtotal						
WB	Left Turn						
	Through						
	Right Turn						
	Subtotal						
Total		400	405	101.2%	7.7	3.2	A

Vissim Post-Processor  
 Average Results from 10 Runs  
 Queue Length

Snow Park Village  
 2040 Plus Project - Circulation Analysis  
 AM Peak Hour

Intersection 1      Deer Valley Drive East/Doe Pass Road      Signal

Direction	Movement	Storage (ft)	Average Queue (ft)			Maximum Queue (ft)			Exceeds Storage?	
			Average	Std. Dev.	Minimum	Maximum	Std. Dev.	Minimum		Maximum
NB	U Turn									
	Second Left									
	Left Turn	300	5	1	4	7	111	20	85	139
	Through Right Turn Second Right									NO
SB	U Turn									
	Second Left									
	Left Turn	150	11	1	9	14	189	19	171	228
	Through Right Turn Second Right	150	9	1	7	12	176	19	158	215
EB	U Turn									
	Second Left									
	Left Turn	75	3	1	2	4	77	12	52	91
	Through Right Turn Second Right	75	6	1	5	7	93	13	69	107
WB	U Turn									
	Second Left									
	Left Turn									
	Through Right Turn Second Right									

**Vissim Post-Processor** **Snow Park Village**  
**Average Results from 10 Runs** **2040 Plus Project - Circulation Analysis**  
**Queue Length** **AM Peak Hour**

**Intersection 2** **Deer Valley Drive West/Doe Pass Road** **Side-street Stop**

Direction	Movement	Storage (ft)	Average Queue (ft)			Maximum Queue (ft)			Exceeds Storage?		
			Average	Std. Dev.	Minimum	Maximum	Std. Dev.	Minimum		Maximum	
NB	U Turn										
	Second Left	200	1	0	0	1	27	3	24	32	NO
	Left Turn										
	Through										
SB	Right Turn										
	Second Right										
	U Turn										
	Second Left										
EB	Left Turn										
	Through										
	Right Turn	500	16	17	1	47	151	88	40	280	NO
	Second Right	500	29	26	3	75	209	80	77	339	NO
WB	U Turn										
	Second Left										
	Left Turn										
	Through	100	0	0	0	0	0	0	0	0	NO
WB	Right Turn										
	Second Right										

Vissim Post-Processor  
 Average Results from 10 Runs  
 Queue Length

Snow Park Village  
 2040 Plus Project - Circulation Analysis  
 AM Peak Hour

Intersection 3      Deer Valley Drive East/Queen Esther Drive      Side-street Stop

Direction	Movement	Storage (ft)	Average Queue (ft)			Maximum Queue (ft)			Exceeds Storage?	
			Average	Std. Dev.	Minimum	Maximum	Std. Dev.	Minimum		Maximum
NB	U Turn									
	Second Left									
	Left Turn	500	0	0	0	0	0	0	NO	
	Through	500	0	0	0	0	0	0	NO	
SB	Right Turn									
	Second Right									
	U Turn									
	Second Left									
EB	Left Turn	500	4	2	1	6	39	83	199	NO
	Through	500	3	1	1	4	39	45	165	NO
	Right Turn									
	Second Right									
WB	U Turn									
	Second Left									
	Left Turn	500	3	0	3	3	4	48	57	NO
	Through	500	4	0	4	5	4	64	73	NO
Right Turn										
Second Right										







**Vissim Post-Processor** **Snow Park Village**  
**Average Results from 10 Runs** **2040 Plus Project - Circulation Analysis**  
**Queue Length** **AM Peak Hour**

**Intersection 6** **P2 Parking/Doe Pass Road** **Side-street Stop**

Direction	Movement	Storage (ft)	Average Queue (ft)			Maximum Queue (ft)			Exceeds Storage?		
			Average	Std. Dev.	Minimum	Maximum	Std. Dev.	Minimum		Maximum	
NB	U Turn	150	4	0	4	4	74	1	72	76	NO
	Second Left										
	Left Turn										
	Through										
SB	Right Turn										
	Second Right										
	U Turn										
	Second Left										
EB	Left Turn										
	Through										
	Right Turn										
	Second Right										
WB	U Turn	75	0	0	0	0	0	0	0	0	NO
	Second Left										
	Left Turn										
	Through										
	Right Turn										
	Second Right										
	U Turn										
	Second Left										
	Left Turn										
	Through										
	Right Turn										
	Second Right										



Vissim Post-Processor  
 Average Results from 10 Runs  
 Queue Length

Snow Park Village  
 2040 Plus Project - Circulation Analysis  
 AM Peak Hour

Intersection 8      Mobility Hub Entrance/Doe Pass Road      Side-street Stop

Direction	Movement	Storage (ft)	Average Queue (ft)			Maximum Queue (ft)			Exceeds Storage?
			Average	Std. Dev.	Maximum	Average	Std. Dev.	Maximum	
NB	U Turn								
	Second Left								
	Left Turn								
	Through								
SB	Right Turn								
	Second Right								
	U Turn								
	Second Left								
EB	Left Turn								
	Through	75	0	0	0	16	0	37	NO
	Right Turn	75	0	0	0	16	0	37	NO
	Second Right								
WB	U Turn								
	Second Left								
	Left Turn	100	0	0	0	8	0	16	NO
	Through	100	0	0	0	0	0	0	NO
	Right Turn								
	Second Right								

Vissim Post-Processor  
Average Results from 10 Runs  
Queue Length

Snow Park Village  
2040 Plus Project - Circulation Analysis  
AM Peak Hour

Intersection 9 Mobility Hub Exit/Doe Pass Road

Side-street Stop

Direction	Movement	Storage (ft)	Average Queue (ft)			Maximum Queue (ft)			Exceeds Storage?	
			Average	Std. Dev.	Minimum	Maximum	Std. Dev.	Minimum		Maximum
NB	U Turn									
	Second Left	100	20	5	13	27	6	125	139	MAX
	Left Turn									
	Through									
SB	Right Turn	100	17	5	11	23	4	126	140	MAX
	Second Right									
	U Turn									
	Second Left									
EB	Left Turn									
	Through									
	Right Turn	100	0	0	0	1	11	0	37	NO
	Second Right									
WB	U Turn									
	Second Left									
	Left Turn									
	Through	75	0	0	0	0	0	0	0	NO
WB	Right Turn									
	Second Right									

Vissim Post-Processor  
 Average Results from 10 Runs  
 Queue Length

Snow Park Village  
 2040 Plus Project - Circulation Analysis  
 AM Peak Hour

Intersection 10      Deer Valley Drive East/P2 Parking      Side-street Stop

Direction	Movement	Storage (ft)	Average Queue (ft)			Maximum Queue (ft)			Exceeds Storage?
			Average	Std. Dev.	Minimum	Maximum	Std. Dev.	Minimum	
NB	U Turn								
	Second Left								
	Left Turn	160	0	0	0	0	0	0	NO
	Through Right Turn Second Right								
SB	U Turn								
	Second Left								
	Left Turn	300	0	0	0	0	0	49	NO
	Through Right Turn Second Right	50	0	0	0	0	0	49	NO
EB	U Turn								
	Second Left								
	Left Turn	150	5	0	4	5	86	109	NO
	Through Right Turn Second Right								
WB	U Turn								
	Second Left								
	Left Turn								
	Through Right Turn Second Right								







Vissim Post-Processor  
 Average Results from 10 Runs  
 Queue Length

Snow Park Village  
 2040 Plus Project - Circulation Analysis  
 AM Peak Hour

Intersection 13 Deer Valley Drive East/Pick-up/Drop-off

Uncontrolled

Direction	Movement	Storage (ft)	Average Queue (ft)			Maximum Queue (ft)			Exceeds Storage?
			Average	Std. Dev.	Maximum	Average	Std. Dev.	Maximum	
NB	U Turn								
	Second Left								
	Left Turn	150	0	0	1	5	76	89	NO
	Through Right Turn Second Right								
SB	U Turn								
	Second Left								
	Left Turn	150	0	0	0	9	0	28	NO
	Through Right Turn Second Right								
EB	U Turn								
	Second Left								
	Left Turn								
	Through Right Turn Second Right								
WB	U Turn								
	Second Left								
	Left Turn								
	Through Right Turn Second Right								

**Intersection 1**                      **Deer Valley Drive East/Doe Pass Road**                      **Signal**

Direction	Movement	Demand Volume (vph)	Served Volume (vph)		Total Delay (sec/veh)		LOS
			Average	Percent	Average	Std. Dev.	
NB	Left Turn	1,050	1,012	96.4%	3.8	0.6	A
	Through						
	Right Turn						
	Subtotal	1,050	1,012	96.4%	3.8	0.6	A
SB	Left Turn	240	226	94.2%	2.9	0.9	A
	Through						
	Right Turn						
	Subtotal	255	241	94.4%	2.9	0.8	A
EB	Left Turn	26	25	96.2%	13.8	4.0	B
	Through						
	Right Turn						
	Subtotal	26	25	96.2%	13.8	4.0	B
WB	Left Turn						
	Through						
	Right Turn						
	Subtotal						
<b>Total</b>		<b>1,331</b>	<b>1,278</b>	<b>96.0%</b>	<b>3.8</b>	<b>0.6</b>	<b>A</b>

**Intersection 2**                      **Deer Valley Drive West/Doe Pass Road**                      **Side-street Stop**

Direction	Movement	Demand Volume (vph)	Served Volume (vph)		Total Delay (sec/veh)		LOS
			Average	Percent	Average	Std. Dev.	
NB	Left Turn	20	16	80.0%	7.6	1.0	A
	Through						
	Right Turn						
	Subtotal	20	16	80.0%	7.6	1.0	A
SB	Left Turn						
	Through						
	Right Turn						
	Subtotal						
EB	Left Turn	204	245	120.1%	2.7	0.6	A
	Through						
	Right Turn						
	Subtotal	224	265	118.5%	2.7	0.5	A
WB	Left Turn	60	58	96.3%	0.6	0.0	A
	Through						
	Right Turn						
	Subtotal	60	58	96.3%	0.6	0.0	A
<b>Total</b>		<b>304</b>	<b>339</b>	<b>111.6%</b>	<b>2.6</b>	<b>0.4</b>	<b>A</b>

**Intersection 3**                      **Deer Valley Drive East/Queen Esther Drive**                      **Side-street Stop**

Direction	Movement	Demand Volume (vph)	Served Volume (vph)		Total Delay (sec/veh)		
			Average	Percent	Average	Std. Dev.	LOS
NB	Left Turn						
	Through	1,080	1,026	95.0%	5.2	0.7	A
	Right Turn	30	45	148.7%	4.4	1.1	A
	Subtotal	1,110	1,071	96.5%	5.1	0.7	A
SB	Left Turn	85	79	92.6%	49.3	34.6	E
	Through	275	255	92.5%	34.5	32.6	D
	Right Turn						
	Subtotal	360	333	92.6%	37.9	33.5	E
EB	Left Turn						
	Through						
	Right Turn						
	Subtotal						
WB	Left Turn	30	29	96.3%	19.9	5.1	C
	Through						
	Right Turn	60	60	99.2%	19.8	5.4	C
	Subtotal	90	88	98.2%	19.9	4.2	C
<b>Total</b>		<b>1,560</b>	<b>1,493</b>	<b>95.7%</b>	<b>13.3</b>	<b>7.9</b>	<b>B</b>

**Intersection 4**                      **Solamere Drive/Deer Valley Drive East**                      **Side-street Stop**

Direction	Movement	Demand Volume (vph)	Served Volume (vph)		Total Delay (sec/veh)		
			Average	Percent	Average	Std. Dev.	LOS
NB	Left Turn						
	Through						
	Right Turn						
	Subtotal						
SB	Left Turn	20	19	92.5%	26.1	16.9	D
	Through						
	Right Turn	80	79	99.3%	20.0	9.3	C
	Subtotal	100	98	97.9%	21.0	9.4	C
EB	Left Turn	90	102	112.9%	124.3	47.2	F
	Through	340	317	93.3%	109.2	47.9	F
	Right Turn						
	Subtotal	430	419	97.4%	113.1	47.9	F
WB	Left Turn						
	Through	1,105	1,031	93.3%	4.0	1.2	A
	Right Turn	35	51	146.0%	3.4	1.4	A
	Subtotal	1,140	1,082	94.9%	3.9	1.2	A
<b>Total</b>		<b>1,670</b>	<b>1,599</b>	<b>95.7%</b>	<b>32.4</b>	<b>12.0</b>	<b>D</b>

**Intersection 5**                      **Deer Valley Drive West/Deer Valley Drive East**                      **Side-street Stop**

Direction	Movement	Demand Volume (vph)	Served Volume (vph)		Total Delay (sec/veh)		
			Average	Percent	Average	Std. Dev.	LOS
NB	Left Turn						
	Through	35	29	83.4%	21.3	5.2	C
	Right Turn	45	44	98.2%	15.2	3.7	C
	Subtotal	80	73	91.8%	17.5	3.3	C
SB	Left Turn	385	380	98.7%	12.7	1.5	B
	Through	199	239	119.9%	4.6	1.0	A
	Right Turn						
	Subtotal	584	619	106.0%	9.7	1.0	A
EB	Left Turn						
	Through						
	Right Turn						
	Subtotal						
WB	Left Turn	25	26	105.2%	27.3	13.4	D
	Through						
	Right Turn	1,160	1,084	93.4%	24.5	7.7	C
	Subtotal	1,185	1,110	93.7%	24.5	7.7	C
Total		1,849	1,802	97.5%	19.4	4.9	C

**Intersection 6**                      **P2 Parking/Doe Pass Road**                      **Side-street Stop**

Direction	Movement	Demand Volume (vph)	Served Volume (vph)		Total Delay (sec/veh)		
			Average	Percent	Average	Std. Dev.	LOS
NB	Left Turn	45	44	97.8%	9.9	1.1	A
	Through						
	Right Turn						
	Subtotal	45	44	97.8%	9.9	1.1	A
SB	Left Turn						
	Through						
	Right Turn						
	Subtotal						
EB	Left Turn						
	Through	27	35	131.1%	0.9	0.5	A
	Right Turn	177	210	118.6%	1.0	0.3	A
	Subtotal	204	245	120.3%	1.0	0.3	A
WB	Left Turn						
	Through	15	14	92.0%	0.0	0.0	A
	Right Turn						
	Subtotal	15	14	92.0%	0.0	0.0	A
Total		264	303	114.8%	2.1	0.3	A

**Intersection 7**                      **P1 Parking/Doe Pass Road**                      **Side-street Stop**

Direction	Movement	Demand Volume (vph)	Served Volume (vph)		Total Delay (sec/veh)		
			Average	Percent	Average	Std. Dev.	LOS
NB	Left Turn						
	Through						
	Right Turn	11	10	90.0%	6.2	0.8	A
	Subtotal	11	10	90.0%	6.2	0.8	A
SB	Left Turn						
	Through						
	Right Turn						
	Subtotal						
EB	Left Turn						
	Through	15	15	100.0%	0.5	0.2	A
	Right Turn	12	20	170.0%	0.3	0.0	A
	Subtotal	27	35	131.1%	0.4	0.1	A
WB	Left Turn						
	Through	15	14	92.0%	0.0	0.0	A
	Right Turn						
	Subtotal	15	14	92.0%	0.0	0.0	A
Total		53	59	111.5%	1.4	0.2	A

**Intersection 8**                      **Mobility Hub Entrance/Doe Pass Road**                      **Side-street Stop**

Direction	Movement	Demand Volume (vph)	Served Volume (vph)		Total Delay (sec/veh)		
			Average	Percent	Average	Std. Dev.	LOS
NB	Left Turn						
	Through						
	Right Turn						
	Subtotal						
SB	Left Turn						
	Through						
	Right Turn						
	Subtotal						
EB	Left Turn						
	Through	11	10	90.0%	0.1	0.0	A
	Right Turn	15	12	80.0%	0.0	0.0	A
	Subtotal	26	22	84.2%	0.1	0.0	A
WB	Left Turn	15	13	84.0%	0.7	0.8	A
	Through	15	14	92.0%	0.0	0.0	A
	Right Turn						
	Subtotal	30	26	88.0%	0.4	0.4	A
Total		56	48	86.3%	0.2	0.2	A

**Intersection 9**                      **Mobility Hub Exit-Pick-up/Drop-off/Doe Pass Road**                      **Side-street Stop**

Direction	Movement	Demand Volume (vph)	Served Volume (vph)		Total Delay (sec/veh)		
			Average	Percent	Average	Std. Dev.	LOS
NB	Left Turn	15	14	92.0%	20.7	3.5	C
	Through						
	Right Turn	15	15	100.0%	10.0	2.5	A
	Subtotal	30	29	96.0%	15.1	2.8	C
SB	Left Turn						
	Through						
	Right Turn						
	Subtotal						
EB	Left Turn						
	Through	11	10	90.0%	0.6	0.7	A
	Right Turn						
	Subtotal	11	10	90.0%	0.6	0.7	A
WB	Left Turn						
	Through	15	15	97.3%	0.1	0.1	A
	Right Turn						
	Subtotal	15	15	97.3%	0.1	0.1	A
Total		56	53	95.2%	9.1	1.6	A

**Intersection 10**                      **Deer Valley Drive East/P2 Parking**                      **Side-street Stop**

Direction	Movement	Demand Volume (vph)	Served Volume (vph)		Total Delay (sec/veh)		
			Average	Percent	Average	Std. Dev.	LOS
NB	Left Turn						
	Through	681	660	96.9%	1.4	0.5	A
	Right Turn						
	Subtotal	681	660	96.9%	1.4	0.5	A
SB	Left Turn						
	Through	190	178	93.4%	2.1	0.5	A
	Right Turn	50	48	95.8%	0.6	0.3	A
	Subtotal	240	225	93.9%	1.8	0.4	A
EB	Left Turn	369	353	95.7%	10.2	0.9	B
	Through						
	Right Turn						
	Subtotal	369	353	95.7%	10.2	0.9	B
WB	Left Turn						
	Through						
	Right Turn						
	Subtotal						
Total		1,290	1,239	96.0%	4.0	0.3	A



**Intersection 11**                      **Deer Valley Drive East/P3 Parking**                      **Side-street Stop**

Direction	Movement	Demand Volume (vph)	Served Volume (vph)		Total Delay (sec/veh)		
			Average	Percent	Average	Std. Dev.	LOS
NB	Left Turn	318	301	94.6%	2.2	0.5	A
	Through						
	Right Turn						
	Subtotal						
SB	Left Turn	190	177	93.3%	4.2	1.8	A
	Through						
	Right Turn						
	Subtotal						
EB	Left Turn	363	359	99.0%	10.4	0.9	B
	Through						
	Right Turn						
	Subtotal						
WB	Left Turn						
	Through						
	Right Turn						
	Subtotal						
Total		871	837	96.1%	6.2	0.6	A

**Intersection 12**                      **Deer Valley Drive East/P4 Parking**                      **Side-street Stop**

Direction	Movement	Demand Volume (vph)	Served Volume (vph)		Total Delay (sec/veh)		
			Average	Percent	Average	Std. Dev.	LOS
NB	Left Turn	200	205	102.3%	2.0	0.8	A
	Through						
	Right Turn						
	Subtotal						
SB	Left Turn	150	138	91.7%	2.4	1.6	A
	Through						
	Right Turn						
	Subtotal						
EB	Left Turn	118	96	81.5%	16.7	1.5	C
	Through						
	Right Turn						
	Subtotal						
WB	Left Turn						
	Through						
	Right Turn						
	Subtotal						
Total		558	549	98.4%	6.8	0.6	A

Vissim Post-Processor  
Average Results from 10 Runs  
Volume and Delay by Movement

Snow Park Village  
2040 Plus Project - Circulation Analysis  
PM Peak Hour

Intersection 13                      Deer Valley Drive East/Pick-up/Drop-off                      Uncontrolled

Direction	Movement	Demand Volume (vph)	Served Volume (vph)		Total Delay (sec/veh)		
			Average	Percent	Average	Std. Dev.	LOS
NB	Left Turn	200	205	102.3%	15.3	2.5	C
	Through						
	Right Turn						
	Subtotal						
SB	Left Turn	200	208	103.8%	1.8	0.9	A
	Through						
	Right Turn						
	Subtotal						
EB	Left Turn						
	Through						
	Right Turn						
	Subtotal						
WB	Left Turn						
	Through						
	Right Turn						
	Subtotal						
Total		400	412	103.0%	8.6	1.4	A







**Vissim Post-Processor** **Snow Park Village**  
**Average Results from 10 Runs** **2040 Plus Project - Circulation Analysis**  
**Queue Length** **PM Peak Hour**

**Intersection 4** **Solamere Drive/Deer Valley Drive East** **Side-street Stop**

Direction	Movement	Storage (ft)	Average Queue (ft)			Maximum Queue (ft)			Exceeds Storage?		
			Average	Std. Dev.	Maximum	Average	Std. Dev.	Maximum			
NB	U Turn										
	Second Left										
	Left Turn										
	Through										
SB	Right Turn										
	Second Right										
	U Turn										
	Second Left	500	8	1	5	10	83	9	71	103	NO
EB	Left Turn	500	11	2	9	14	90	9	78	111	NO
	Through										
	Right Turn										
	Second Right										
WB	U Turn										
	Second Left										
	Left Turn	500	238	78	130	395	742	143	524	1,000	MAX
	Through	500	211	76	106	363	705	143	487	963	MAX
WB	Right Turn										
	Second Right										
	U Turn										
	Second Left										
WB	Left Turn	500	2	4	0	14	35	67	0	219	NO
	Through	500	2	4	0	14	35	67	0	219	NO
	Right Turn										
	Second Right										

Vissim Post-Processor  
 Average Results from 10 Runs  
 Queue Length

Snow Park Village  
 2040 Plus Project - Circulation Analysis  
 PM Peak Hour

Intersection 5 Deer Valley Drive West/Deer Valley Drive East

Side-street Stop

Direction	Movement	Storage (ft)	Average Queue (ft)			Maximum Queue (ft)			Exceeds Storage?
			Average	Std. Dev.	Minimum	Maximum	Std. Dev.	Minimum	
NB	U Turn								
	Second Left								
	Left Turn	500	9	2	8	12	118	155	NO
	Through	500	8	1	7	10	112	149	NO
SB	Right Turn								
	Second Right								
	U Turn								
	Second Left	100	0	0	0	0	0	0	NO
EB	Left Turn	500	0	0	0	0	0	0	NO
	Through								
	Right Turn								
	Second Right								
WB	U Turn								
	Second Left	500	1	0	1	2	35	49	NO
	Left Turn								
	Through	100	1	4	0	11	0	336	NO
	Right Turn								
	Second Right								
	U Turn								
	Second Left								







Vissim Post-Processor  
 Average Results from 10 Runs  
 Queue Length

Snow Park Village  
 2040 Plus Project - Circulation Analysis  
 PM Peak Hour

Intersection 8 Mobility Hub Entrance/Doe Pass Road

Side-street Stop

Direction	Movement	Storage (ft)	Average Queue (ft)			Maximum Queue (ft)			Exceeds Storage?
			Average	Std. Dev.	Maximum	Average	Std. Dev.	Maximum	
NB	U Turn								
	Second Left								
	Left Turn								
	Through								
SB	Right Turn								
	Second Right								
	U Turn								
	Second Left								
EB	Left Turn								
	Through	75	0	0	0	5	0	12	NO
	Right Turn	75	0	0	0	5	0	12	NO
	Second Right								
WB	U Turn								
	Second Left								
	Left Turn	100	0	0	0	6	0	15	NO
	Through	100	0	0	0	0	0	0	NO
	Right Turn								
	Second Right								

Vissim Post-Processor  
 Average Results from 10 Runs  
 Queue Length

Snow Park Village  
 2040 Plus Project - Circulation Analysis  
 PM Peak Hour

Intersection 9 Mobility Hub Exit-Pick-up/Drop-off/Doe Pass Road

Side-street Stop

Direction	Movement	Storage (ft)	Average Queue (ft)			Maximum Queue (ft)			Exceeds Storage?	
			Average	Std. Dev.	Minimum	Maximum	Std. Dev.	Minimum		Maximum
NB	U Turn									
	Second Left	100	25	5	18	32	11	138	171	MAX
	Left Turn									
	Through									
SB	Right Turn	100	25	5	18	32	12	140	174	MAX
	Second Right									
	U Turn									
	Second Left									
EB	Left Turn									
	Through									
	Right Turn	100	0	0	0	0	6	0	17	NO
	Second Right									
WB	U Turn									
	Second Left									
	Left Turn									
	Through	75	0	0	0	0	0	0	0	NO
WB	Right Turn									
	Second Right									

**Vissim Post-Processor** **Snow Park Village**  
**Average Results from 10 Runs** **2040 Plus Project - Circulation Analysis**  
**Queue Length** **PM Peak Hour**

**Intersection 10** **Deer Valley Drive East/P2 Parking** **Side-street Stop**

Direction	Movement	Storage (ft)	Average Queue (ft)			Maximum Queue (ft)			Exceeds Storage?
			Average	Std. Dev.	Minimum	Maximum	Std. Dev.	Minimum	
NB	U Turn								
	Second Left								
	Left Turn	160	0	0	0	10	11	0	30
	Through								
SB	Right Turn								
	Second Right								
	U Turn								
	Second Left								
	Left Turn								
EB	Through	300	0	0	0	0	0	0	0
	Right Turn	50	0	0	0	0	0	0	0
	Second Right								
	U Turn								
	Second Left								
WB	Left Turn	150	98	2	96	115	1	113	116
	Through								
	Right Turn								
	Second Right								
	U Turn								

Vissim Post-Processor  
 Average Results from 10 Runs  
 Queue Length

Snow Park Village  
 2040 Plus Project - Circulation Analysis  
 PM Peak Hour

Intersection 11      Deer Valley Drive East/P3 Parking      Side-street Stop

Direction	Movement	Storage (ft)	Average Queue (ft)			Maximum Queue (ft)			Exceeds Storage?
			Average	Std. Dev.	Minimum	Maximum	Std. Dev.	Minimum	
NB	U Turn								
	Second Left								
	Left Turn	200	3	1	2	4	17	67	115
	Through Right Turn Second Right								
SB	U Turn								
	Second Left								
	Left Turn	160	3	1	2	5	44	50	167
	Through Right Turn Second Right								
EB	U Turn								
	Second Left								
	Left Turn	150	75	1	74	76	1	94	97
	Through Right Turn Second Right								
WB	U Turn								
	Second Left								
	Left Turn								
	Through Right Turn Second Right								

Vissim Post-Processor  
 Average Results from 10 Runs  
 Queue Length

Snow Park Village  
 2040 Plus Project - Circulation Analysis  
 PM Peak Hour

Intersection 12      Deer Valley Drive East/P4 Parking      Side-street Stop

Direction	Movement	Storage (ft)	Average Queue (ft)			Maximum Queue (ft)			Exceeds Storage?	
			Average	Std. Dev.	Minimum	Maximum	Std. Dev.	Minimum		Maximum
NB	U Turn									
	Second Left									
	Left Turn	100	0	0	0	0	0	0	NO	
	Through									
SB	Right Turn									
	Second Right									
	U Turn									
	Second Left									
EB	Left Turn	75	0	0	0	0	0	0	NO	
	Through	75	0	0	0	0	0	0	NO	
	Right Turn									
	Second Right									
WB	U Turn									
	Second Left									
	Left Turn	150	6	2	4	10	24	83	151	NO
	Through									
WB	Right Turn	150	6	1	4	8	23	83	153	NO
	Second Right									
	U Turn									
	Second Left									
WB	Left Turn									
	Through									
	Right Turn									
	Second Right									

Vissim Post-Processor  
 Average Results from 10 Runs  
 Queue Length

Snow Park Village  
 2040 Plus Project - Circulation Analysis  
 PM Peak Hour

Intersection 13 Deer Valley Drive East/Pick-up/Drop-off

Uncontrolled

Direction	Movement	Storage (ft)	Average Queue (ft)			Maximum Queue (ft)			Exceeds Storage?		
			Average	Std. Dev.	Maximum	Average	Std. Dev.	Maximum			
NB	U Turn										
	Second Left										
	Left Turn	150	1	2	0	6	6	88	24	138	
	Through Right Turn Second Right										NO
SB	U Turn										
	Second Left										
	Left Turn	150	0	1	0	4	4	14	21	54	
	Through Right Turn Second Right										NO
EB	U Turn										
	Second Left										
	Left Turn										
	Through Right Turn Second Right										
WB	U Turn										
	Second Left										
	Left Turn										
	Through Right Turn Second Right										



**Intersection 1**                      **Deer Valley Drive East/Doe Pass Road**                      **Signal**

Direction	Movement	Demand Volume (vph)	Served Volume (vph)		Total Delay (sec/veh)		
			Average	Percent	Average	Std. Dev.	LOS
NB	Left Turn	530	520	98.1%	2.3	0.5	A
	Through						
	Right Turn						
	Subtotal	530	520	98.1%	2.3	0.5	A
SB	Left Turn	110	103	93.6%	2.3	1.6	A
	Through						
	Right Turn						
	Subtotal	125	118	94.4%	2.4	1.4	A
EB	Left Turn	26	25	95.8%	6.2	2.6	A
	Through						
	Right Turn						
	Subtotal	26	25	95.8%	6.2	2.6	A
WB	Left Turn						
	Through						
	Right Turn						
	Subtotal						
Total		681	663	97.3%	2.5	0.5	A

**Intersection 2**                      **Deer Valley Drive West/Doe Pass Road**                      **Side-street Stop**

Direction	Movement	Demand Volume (vph)	Served Volume (vph)		Total Delay (sec/veh)		
			Average	Percent	Average	Std. Dev.	LOS
NB	Left Turn	20	16	80.0%	7.0	0.8	A
	Through						
	Right Turn						
	Subtotal	20	16	80.0%	7.0	0.8	A
SB	Left Turn						
	Through						
	Right Turn						
	Subtotal						
EB	Left Turn	50	28	55.8%	0.5	0.9	A
	Through						
	Right Turn						
	Subtotal	70	66	94.4%	1.1	0.5	A
WB	Left Turn	45	43	96.2%	0.6	0.0	A
	Through						
	Right Turn						
	Subtotal	45	43	96.2%	0.6	0.0	A
Total		135	125	92.9%	1.7	0.3	A

Vissim Post-Processor  
Average Results from 10 Runs  
Volume and Delay by Movement

Snow Park Village  
2040 Plus Project - Circulation Analysis - Weekday Sensitivity  
PM Peak Hour

Intersection 3                      Deer Valley Drive East/Queen Esther Drive                      Side-street Stop

Direction	Movement	Demand Volume (vph)	Served Volume (vph)		Total Delay (sec/veh)		
			Average	Percent	Average	Std. Dev.	LOS
NB	Left Turn						
	Through	560	532	94.9%	2.6	0.3	A
	Right Turn	30	45	148.7%	2.5	0.8	A
	Subtotal	590	576	97.7%	2.6	0.3	A
SB	Left Turn	85	69	80.9%	6.2	2.3	A
	Through	145	130	89.8%	2.2	0.8	A
	Right Turn						
	Subtotal	230	199	86.5%	3.5	1.0	A
EB	Left Turn						
	Through						
	Right Turn						
	Subtotal						
WB	Left Turn	30	29	97.7%	10.0	2.7	A
	Through						
	Right Turn	60	60	99.5%	9.2	1.8	A
	Subtotal	90	89	98.9%	9.4	1.6	A
Total		910	864	95.0%	3.6	0.4	A

Intersection 4                      Solamere Drive/Deer Valley Drive East                      Side-street Stop

Direction	Movement	Demand Volume (vph)	Served Volume (vph)		Total Delay (sec/veh)		
			Average	Percent	Average	Std. Dev.	LOS
NB	Left Turn						
	Through						
	Right Turn						
	Subtotal						
SB	Left Turn	20	21	103.5%	10.7	3.2	B
	Through						
	Right Turn	80	77	96.5%	8.7	1.2	A
	Subtotal	100	98	97.9%	9.0	1.3	A
EB	Left Turn	90	81	90.1%	15.7	3.6	C
	Through	210	179	85.2%	12.6	2.8	B
	Right Turn						
	Subtotal	300	260	86.7%	13.7	2.4	B
WB	Left Turn						
	Through	585	541	92.4%	2.0	0.3	A
	Right Turn	35	51	146.6%	1.9	0.5	A
	Subtotal	620	592	95.5%	2.0	0.2	A
Total		1,020	950	93.1%	6.2	0.6	A

Vissim Post-Processor  
Average Results from 10 Runs  
Volume and Delay by Movement

Snow Park Village  
2040 Plus Project - Circulation Analysis - Weekday Sensitivity  
PM Peak Hour

Intersection 5                      Deer Valley Drive West/Deer Valley Drive East                      Side-street Stop

Direction	Movement	Demand Volume (vph)	Served Volume (vph)		Total Delay (sec/veh)		
			Average	Percent	Average	Std. Dev.	LOS
NB	Left Turn						
	Through	35	30	85.7%	24.9	3.6	C
	Right Turn	30	29	97.0%	14.1	5.8	B
	Subtotal	65	59	90.9%	19.5	4.1	C
SB	Left Turn	270	230	85.3%	5.5	0.8	A
	Through	50	46	91.2%	2.3	2.2	A
	Right Turn						
	Subtotal	320	276	86.2%	5.0	1.0	A
EB	Left Turn						
	Through						
	Right Turn						
	Subtotal						
WB	Left Turn	20	21	103.0%	10.6	2.7	B
	Through						
	Right Turn	645	597	92.5%	9.3	0.8	A
	Subtotal	665	617	92.8%	9.3	0.8	A
Total		1,050	952	90.7%	8.8	0.7	A

Intersection 6                      P2 Parking/Doe Pass Road                      Side-street Stop

Direction	Movement	Demand Volume (vph)	Served Volume (vph)		Total Delay (sec/veh)		
			Average	Percent	Average	Std. Dev.	LOS
NB	Left Turn	30	29	97.7%	7.7	0.7	A
	Through						
	Right Turn						
	Subtotal	30	29	97.7%	7.7	0.7	A
SB	Left Turn						
	Through						
	Right Turn						
	Subtotal						
EB	Left Turn						
	Through	27	26	94.8%	0.1	0.1	A
	Right Turn	23	2	10.0%	0.1	0.2	A
	Subtotal	50	28	55.8%	0.1	0.1	A
WB	Left Turn						
	Through	15	14	94.7%	0.0	0.0	A
	Right Turn						
	Subtotal	15	14	94.7%	0.0	0.0	A
Total		95	71	75.2%	3.3	0.4	A

Vissim Post-Processor  
Average Results from 10 Runs  
Volume and Delay by Movement

Snow Park Village  
2040 Plus Project - Circulation Analysis - Weekday Sensitivity  
PM Peak Hour

Intersection 7 P1 Parking/Doe Pass Road Side-street Stop

Direction	Movement	Demand Volume (vph)	Served Volume (vph)		Total Delay (sec/veh)		
			Average	Percent	Average	Std. Dev.	LOS
NB	Left Turn						
	Through						
	Right Turn	11	10	90.0%	6.0	0.3	A
	Subtotal	11	10	90.0%	6.0	0.3	A
SB	Left Turn						
	Through						
	Right Turn						
	Subtotal						
EB	Left Turn						
	Through	15	15	100.0%	0.5	0.2	A
	Right Turn	12	11	90.0%	0.5	0.6	A
	Subtotal	27	26	95.6%	0.5	0.4	A
WB	Left Turn						
	Through	15	14	94.7%	0.0	0.0	A
	Right Turn						
	Subtotal	15	14	94.7%	0.0	0.0	A
Total		53	50	94.2%	1.5	0.3	A

Intersection 8 Mobility Hub Entrance/Doe Pass Road Side-street Stop

Direction	Movement	Demand Volume (vph)	Served Volume (vph)		Total Delay (sec/veh)		
			Average	Percent	Average	Std. Dev.	LOS
NB	Left Turn						
	Through						
	Right Turn						
	Subtotal						
SB	Left Turn						
	Through						
	Right Turn						
	Subtotal						
EB	Left Turn						
	Through	11	10	90.0%	0.1	0.0	A
	Right Turn	15	12	80.0%	0.0	0.1	A
	Subtotal	26	22	84.2%	0.1	0.0	A
WB	Left Turn	15	13	86.7%	0.3	0.1	A
	Through	15	14	94.7%	0.0	0.0	A
	Right Turn						
	Subtotal	30	27	90.7%	0.2	0.1	A
Total		56	49	87.7%	0.1	0.0	A

Vissim Post-Processor  
Average Results from 10 Runs  
Volume and Delay by Movement

Snow Park Village  
2040 Plus Project - Circulation Analysis - Weekday Sensitivity  
PM Peak Hour

Intersection 9                      Mobility Hub Exit-Pick-up/Drop-off/Doe Pass Road                      Side-street Stop

Direction	Movement	Demand Volume (vph)	Served Volume (vph)		Total Delay (sec/veh)		
			Average	Percent	Average	Std. Dev.	LOS
NB	Left Turn	15	14	95.3%	20.5	3.2	C
	Through						
	Right Turn	15	15	100.0%	8.2	0.4	A
	Subtotal	30	29	97.7%	14.3	1.6	B
SB	Left Turn						
	Through						
	Right Turn						
	Subtotal						
EB	Left Turn						
	Through	11	10	90.0%	0.7	0.8	A
	Right Turn						
	Subtotal	11	10	90.0%	0.7	0.8	A
WB	Left Turn						
	Through	15	15	100.0%	0.1	0.0	A
	Right Turn						
	Subtotal	15	15	100.0%	0.1	0.0	A
Total		56	54	96.8%	8.4	0.8	A

Intersection 10                      Deer Valley Drive East/P2 Parking                      Side-street Stop

Direction	Movement	Demand Volume (vph)	Served Volume (vph)		Total Delay (sec/veh)		
			Average	Percent	Average	Std. Dev.	LOS
NB	Left Turn						
	Through	359	352	97.9%	0.3	0.1	A
	Right Turn						
	Subtotal	359	352	97.9%	0.3	0.1	A
SB	Left Turn						
	Through	60	53	88.3%	0.6	0.2	A
	Right Turn	50	50	100.6%	0.5	0.2	A
	Subtotal	110	103	93.9%	0.6	0.1	A
EB	Left Turn	171	169	98.7%	5.1	0.4	A
	Through						
	Right Turn						
	Subtotal	171	169	98.7%	5.1	0.4	A
WB	Left Turn						
	Through						
	Right Turn						
	Subtotal						
Total		640	624	97.4%	1.6	0.1	A

Vissim Post-Processor  
Average Results from 10 Runs  
Volume and Delay by Movement

Snow Park Village  
2040 Plus Project - Circulation Analysis - Weekday Sensitivity  
PM Peak Hour

Intersection 11                      Deer Valley Drive East/P3 Parking                      Side-street Stop

Direction	Movement	Demand Volume (vph)	Served Volume (vph)		Total Delay (sec/veh)		
			Average	Percent	Average	Std. Dev.	LOS
NB	Left Turn	188	183	97.3%	2.4	0.8	A
	Through						
	Right Turn						
	Subtotal	188	183	97.3%	2.4	0.8	A
SB	Left Turn	60	53	88.7%	2.9	1.5	A
	Through						
	Right Turn						
	Subtotal	60	53	88.7%	2.9	1.5	A
EB	Left Turn	171	168	98.5%	10.7	0.5	B
	Through						
	Right Turn						
	Subtotal	171	168	98.5%	10.7	0.5	B
WB	Left Turn						
	Through						
	Right Turn						
	Subtotal						
Total		419	405	96.5%	6.0	0.6	A

Intersection 12                      Deer Valley Drive East/P4 Parking                      Side-street Stop

Direction	Movement	Demand Volume (vph)	Served Volume (vph)		Total Delay (sec/veh)		
			Average	Percent	Average	Std. Dev.	LOS
NB	Left Turn	70	86	123.4%	1.0	0.5	A
	Through						
	Right Turn						
	Subtotal	70	86	123.4%	1.0	0.5	A
SB	Left Turn	20	17	87.0%	1.6	1.0	A
	Through						
	Right Turn	40	36	89.8%	0.6	0.2	A
	Subtotal	60	53	88.8%	1.0	0.4	A
EB	Left Turn	118	96	81.6%	15.6	0.5	C
	Through						
	Right Turn						
	Subtotal	168	167	99.3%	15.3	0.3	C
WB	Left Turn						
	Through						
	Right Turn						
	Subtotal						
Total		298	307	102.9%	8.8	0.4	A

Vissim Post-Processor  
Average Results from 10 Runs  
Volume and Delay by Movement

Snow Park Village  
2040 Plus Project - Circulation Analysis - Weekday Sensitivity  
PM Peak Hour

Intersection 13                      Deer Valley Drive East/Pick-up/Drop-off                      Uncontrolled

Direction	Movement	Demand Volume (vph)	Served Volume (vph)		Total Delay (sec/veh)		
			Average	Percent	Average	Std. Dev.	LOS
NB	Left Turn	70	87	123.7%	3.9	0.6	A
	Through						
	Right Turn						
	Subtotal						
SB	Left Turn	70	88	125.4%	0.3	0.2	A
	Through						
	Right Turn						
	Subtotal						
EB	Left Turn						
	Through						
	Right Turn						
	Subtotal						
WB	Left Turn						
	Through						
	Right Turn						
	Subtotal						
Total		140	174	124.6%	2.1	0.3	A

# L2 Data Collection

L2DataCollection.com

Study: FEHR0119  
 Type: Volume / Direction  
 Tech: Judd / Mosdell / Anderson  
 Count: Axle Hits / 2

Idaho (208) 860-7554 Utah (801) 413-2993

Date Start: 15-Feb-20  
 Date End: 15-Feb-20  
 Deer Valley Dr E of the DV Dr Split Intersect VOL D1  
 DV Dr east of the DV Dr Split Intersect  
 Deer Valley, Idaho  
 Site Code: Day 1

Start Time	15-Feb-20 Sat	WB	EB							Total
12:00 AM		*	*							*
12:15		10	8							18
12:30		6	6							12
12:45		6	7							13
01:00		4	2							6
01:15		0	1							1
01:30		3	4							7
01:45		3	6							9
02:00		1	4							5
02:15		0	2							2
02:30		0	0							0
02:45		0	0							0
03:00		0	1							1
03:15		1	0							1
03:30		2	0							2
03:45		0	0							0
04:00		0	0							0
04:15		1	1							2
04:30		1	0							1
04:45		1	0							1
05:00		0	0							0
05:15		1	2							3
05:30		3	0							3
05:45		1	3							4
06:00		0	8							8
06:15		3	1							4
06:30		3	16							19
06:45		9	30							39
07:00		14	38							52
07:15		15	60							75
07:30		22	94							116
07:45		22	127							149
08:00		32	106							138
08:15		29	64							93
08:30		54	62							116
08:45		48	52							100
09:00		56	32							88
09:15		51	26							77
09:30		65	46							111
09:45		68	36							104
10:00		66	29							95
10:15		42	29							71
10:30		61	46							107
10:45		56	36							92
11:00		52	38							90
11:15		54	38							92
11:30		60	34							94
11:45		55	33							88
Total		981	1128							2109
Percent		46.5%	53.5%							
Peak	-	09:15	07:30	-	-	-	-	-	-	07:30
Vol.	-	250	391	-	-	-	-	-	-	496
P.H.F.		0.919	0.770							0.832



# L2 Data Collection

Study: FEHR0119  
 Type: Volume / Direction  
 Tech: Judd / Mosdell / Anderson  
 Count: Axle Hits / 2

L2DataCollection.com  
 Idaho (208) 860-7554 Utah (801) 413-2993

Date Start: 15-Feb-20  
 Date End: 15-Feb-20  
 Deer Valley Dr E of the DV Dr Split Intersect VOL D1  
 DV Dr east of the DV Dr Split Intersect  
 Deer Valley, Idaho  
 Site Code: Day 1

Start Time	15-Feb-20 Sat	WB	EB							Total
12:00 PM		90	44							134
12:15		53	30							83
12:30		58	36							94
12:45		84	34							118
01:00		50	50							100
01:15		66	38							104
01:30		48	45							93
01:45		62	40							102
02:00		75	36							111
02:15		66	42							108
02:30		64	37							101
02:45		49	46							95
03:00		61	58							119
03:15		80	48							128
03:30		80	58							138
03:45		92	55							147
04:00		100	52							152
04:15		78	64							142
04:30		109	70							179
04:45		72	62							134
05:00		84	59							143
05:15		64	56							120
05:30		84	58							142
05:45		72	58							130
06:00		73	38							111
06:15		58	59							117
06:30		61	61							122
06:45		51	48							99
07:00		45	53							98
07:15		34	43							77
07:30		42	41							83
07:45		45	36							81
08:00		40	36							76
08:15		32	35							67
08:30		45	40							85
08:45		34	34							68
09:00		36	30							66
09:15		27	30							57
09:30		24	24							48
09:45		34	32							66
10:00		23	24							47
10:15		16	26							42
10:30		20	13							33
10:45		9	10							19
11:00		10	7							17
11:15		*	*							*
11:30		*	*							*
11:45		*	*							*
Total		2500	1896							4396
Percent		56.9%	43.1%							
Peak	-	15:45	16:15	-	-	-	-	-	-	15:45
Vol.	-	379	255	-	-	-	-	-	-	620
P.H.F.		0.869	0.911							0.866
Grand Total		3481	3024							6505
Percent		53.5%	46.5%							

# L2 Data Collection

Study: FEHR0119  
 Type: Volume / Direction  
 Tech: Judd / Mosdell / Anderson  
 Count: Axle Hits / 2

L2DataCollection.com  
 Idaho (208) 860-7554 Utah (801) 413-2993

Date Start: 15-Feb-20  
 Date End: 15-Feb-20  
 Deer Valley Dr N of Parking & S of Queen Esther VOL D1  
 DV Dr N Of Parking & S of Queen Esther  
 Deer Valley, Utah  
 Site Code: Day 1

Start Time	15-Feb-20 Sat	SB	NB							Total
12:00 AM		*	*							*
12:15		*	*							*
12:30		3	2							5
12:45		1	2							3
01:00		0	1							1
01:15		0	1							1
01:30		3	2							5
01:45		1	0							1
02:00		1	0							1
02:15		2	0							2
02:30		0	0							0
02:45		0	0							0
03:00		0	0							0
03:15		0	0							0
03:30		0	2							2
03:45		0	0							0
04:00		0	0							0
04:15		1	3							4
04:30		0	0							0
04:45		0	0							0
05:00		2	0							2
05:15		1	1							2
05:30		0	1							1
05:45		1	0							1
06:00		6	0							6
06:15		1	1							2
06:30		9	2							11
06:45		23	4							27
07:00		31	5							36
07:15		61	8							69
07:30		<b>81</b>	13							94
07:45		<b>106</b>	10							<b>116</b>
08:00		<b>122</b>	26							<b>148</b>
08:15		<b>73</b>	25							<b>98</b>
08:30		72	48							<b>120</b>
08:45		47	44							91
09:00		40	<b>48</b>							88
09:15		38	<b>44</b>							82
09:30		36	<b>50</b>							86
09:45		27	<b>46</b>							73
10:00		21	45							66
10:15		20	33							53
10:30		28	38							66
10:45		21	29							50
11:00		22	34							56
11:15		19	23							42
11:30		21	34							55
11:45		19	24							43
Total		960	649							1609
Percent		59.7%	40.3%							
Peak	-	07:30	09:00	-	-	-	-	-	-	07:45
Vol.	-	382	188	-	-	-	-	-	-	482
P.H.F.		0.783	0.940							0.814

# L2 Data Collection

L2DataCollection.com

Study: FEHR0119  
 Type: Volume / Direction  
 Tech: Judd / Mosdell / Anderson  
 Count: Axle Hits / 2

Idaho (208) 860-7554 Utah (801) 413-2993

Date Start: 15-Feb-20  
 Date End: 15-Feb-20  
 Deer Valley Dr N of Parking & S of Queen Esther VOL D1  
 DV Dr N Of Parking & S of Queen Esther  
 Deer Valley, Utah  
 Site Code: Day 1

Start Time	15-Feb-20 Sat	SB	NB							Total
12:00 PM		22	40							62
12:15		19	28							47
12:30		27	36							63
12:45		19	32							51
01:00		25	26							51
01:15		13	37							50
01:30		20	31							51
01:45		16	41							57
02:00		15	46							61
02:15		21	38							59
02:30		24	44							68
02:45		27	36							63
03:00		28	51							79
03:15		26	56							82
03:30		47	62							109
03:45		44	72							116
04:00		29	80							109
04:15		36	82							118
04:30		40	86							126
04:45		34	52							86
05:00		24	48							72
05:15		22	34							56
05:30		28	62							90
05:45		22	40							62
06:00		14	36							50
06:15		16	33							49
06:30		14	20							34
06:45		16	16							32
07:00		20	23							43
07:15		12	12							24
07:30		8	15							23
07:45		10	16							26
08:00		11	13							24
08:15		8	18							26
08:30		12	15							27
08:45		7	12							19
09:00		15	24							39
09:15		10	13							23
09:30		5	16							21
09:45		5	16							21
10:00		8	17							25
10:15		8	9							17
10:30		4	11							15
10:45		4	8							12
11:00		*	*							*
11:15		*	*							*
11:30		*	*							*
11:45		*	*							*
Total		835	1503							2338
Percent		35.7%	64.3%							
Peak	-	15:30	15:45	-	-	-	-	-	-	15:45
Vol.	-	156	320	-	-	-	-	-	-	469
P.H.F.		0.830	0.930							0.931
Grand Total		1795	2152							3947
Percent		45.5%	54.5%							

# L2 Data Collection

Study: FEHR0119  
 Type: Volume / Direction  
 Tech: Judd / Mosdell / Anderson  
 Count: Axle Hits / 2

L2DataCollection.com  
 Idaho (208) 860-7554 Utah (801) 413-2993

Date Start: 15-Feb-20  
 Date End: 15-Feb-20  
 Deer Valley Dr S of the DV Dr Split Intersect VOL D1  
 DV Dr south of the DV Dr Split Intersect  
 Deer Valley, Utah  
 Site Code: Day 1

Start Time	15-Feb-20 Sat	SB	NB							Total
12:00 AM		6	10							16
12:15		3	6							9
12:30		2	9							11
12:45		4	2							6
01:00		4	3							7
01:15		3	2							5
01:30		0	2							2
01:45		2	1							3
02:00		4	4							8
02:15		0	3							3
02:30		0	0							0
02:45		1	0							1
03:00		1	1							2
03:15		4	1							5
03:30		1	1							2
03:45		1	0							1
04:00		1	3							4
04:15		0	1							1
04:30		0	0							0
04:45		0	1							1
05:00		4	1							5
05:15		2	3							5
05:30		1	0							1
05:45		1	0							1
06:00		4	4							8
06:15		4	2							6
06:30		21	6							27
06:45		28	10							38
07:00		32	10							42
07:15		36	13							49
07:30		62	26							88
07:45		70	22							92
08:00		114	28							142
08:15		127	30							157
08:30		129	38							167
08:45		134	41							175
09:00		113	34							147
09:15		98	34							132
09:30		90	48							138
09:45		98	44							142
10:00		75	42							117
10:15		62	46							108
10:30		48	43							91
10:45		48	40							88
11:00		54	50							104
11:15		48	40							88
11:30		42	31							73
11:45		66	40							106
Total		1648	776							2424
Percent		68.0%	32.0%							
Peak	-	08:00	09:30	-	-	-	-	-	-	08:15
Vol.	-	504	180	-	-	-	-	-	-	646
P.H.F.		0.940	0.938							0.923

# L2 Data Collection

Study: FEHR0119  
 Type: Volume / Direction  
 Tech: Judd / Mosdell / Anderson  
 Count: Axle Hits / 2

L2DataCollection.com  
 Idaho (208) 860-7554 Utah (801) 413-2993

Date Start: 15-Feb-20  
 Date End: 15-Feb-20  
 Deer Valley Dr S of the DV Dr Split Intersect VOL D1  
 DV Dr south of the DV Dr Split Intersect  
 Deer Valley, Utah  
 Site Code: Day 1

Start Time	15-Feb-20 Sat	SB	NB							Total
12:00 PM		44	47							91
12:15		46	34							80
12:30		54	25							79
12:45		43	43							86
01:00		46	36							82
01:15		51	39							90
01:30		45	53							98
01:45		42	40							82
02:00		57	54							111
02:15		54	70							124
02:30		53	78							131
02:45		62	66							128
03:00		63	71							134
03:15		77	74							151
03:30		82	86							168
03:45		64	112							176
04:00		77	146							223
04:15		53	170							223
04:30		53	122							175
04:45		60	106							166
05:00		46	108							154
05:15		34	90							124
05:30		52	116							168
05:45		38	116							154
06:00		48	56							104
06:15		38	48							86
06:30		38	34							72
06:45		40	26							66
07:00		30	24							54
07:15		22	38							60
07:30		34	25							59
07:45		40	30							70
08:00		26	22							48
08:15		31	22							53
08:30		11	18							29
08:45		27	22							49
09:00		18	28							46
09:15		16	21							37
09:30		12	12							24
09:45		16	23							39
10:00		10	19							29
10:15		16	24							40
10:30		9	7							16
10:45		*	*							*
11:00		*	*							*
11:15		*	*							*
11:30		*	*							*
11:45		*	*							*
Total		1778	2401							4179
Percent		42.5%	57.5%							
Peak	-	15:15	15:45	-	-	-	-	-	-	15:45
Vol.	-	300	550	-	-	-	-	-	-	797
P.H.F.		0.915	0.809							0.893
Grand Total		3426	3177							6603
Percent		51.9%	48.1%							



# Attachment A: Trip Generation Memorandum



## MEMORANDUM

Date: January 21, 2022  
To: Alexandra Ananth, Park City Planning  
From: Fehr & Peers  
Subject: **Revised Trip Generation Estimates for the Snow Park Village Traffic Impact Study**

*UT20-2245*

---

This memorandum presents revised trip generation estimates for the proposed Snow Park Village project at Deer Valley Resort. The original trip generation estimates included in the Traffic Impact Study (April 2021) were reviewed by Park City staff and Wall Consulting Group (WCG), a third-party reviewer retained by the City. Park City staff, through WCG, requested revisions to the trip generation estimates with supporting documentation and/or rationale. Revisions presented in this memorandum are based on an updated land use plan, a local precedent study, comparable trip resort analysis, published trip generation rates from the Institute of Transportation Engineers, and mode shift assumptions derived from the Summit County travel demand model. This memorandum is an intermediate deliverable while additional details regarding site access and circulation are being resolved.

In summary, revised trip generation estimates for the Snow Park Village project show 2,276 daily trips, 162 trips in the Saturday AM peak-hour, and 204 trips in the Saturday PM peak hour. When compared with estimates included in the April 2021 traffic impact study, this results in a 60 percent increase in estimated daily trips, 80 percent increase in the Saturday AM peak-hour trips, and a 148 percent increase in the Saturday PM peak-hour trips.

### **Trip Generation Estimates**

Trip generation estimates focus on Saturday AM and PM peak-hour operations due to the nature of how a ski resort operates: skier traffic is consistently highest on Saturdays. Updated trip generation estimates for Snow Park Village are presented below in **Table 1**.



## Key Revisions

Trip generation estimates in this memorandum incorporate several key revisions, including:

- Updated resort hotel trip generation rates taken from the 2018 Canyons Village Transportation Master Plan
- Assumed mode shift away from private car taken from MXD, the Environmental Protection Agency's approved trip generation method, and the Summit County travel demand model for all proposed land uses
- Reductions in trip generation rates due to the implementation of paid parking for day skiers and most proposed land uses
- Reliance on trip internalization derived from MXD and the Summit County travel demand model for most proposed land uses
- The rate of internal capture assumed due to complementary land uses derived from analysis at a peer resort (Palisades at Tahoe, formerly known as Squaw Valley)

This combination of updates represents a much more conservative foundation for subsequent traffic analysis. Each of these changes and justification for each are described in greater detail below.

### Resort Hotel Trip Generation Rates

The third-party reviewers (WCG) noted that the resort hotel trip generation rates appeared unreasonably low based on observed trip generation rates recorded during the development of the 2018 Canyons Village Transportation Master Plan. While there are a handful of key factors that might result in trip generation rates closer to those in the original Snow Park Village Traffic Impact Study, including proximity to the interstate and other complementary land uses, estimates in this memorandum used the local rates recorded at the Canyons.

### Assumed Mode Shift

To avoid double-counting potential reductions, as was the case in the original Snow Park Village traffic impact study, the trip generation estimates in this memorandum rely solely on mode shift derived from the MXD methodology and underlying assumptions from the regional travel demand model. These reductions, which are shown in the columns titled "% Walk/Bike" and "% Transit," are applied to all proposed land uses. This results in a more conservative and defensible analysis,





however, it does not account for the planned changes to transit service in Park City and the world-class transit facility proposed as part of the Snow Park Village project. Potential mode shift to transit for those traveling to and from Deer Valley may be higher following such improvements.

## **Reduction in Vehicle Trips due to Implementation of Paid Parking**

Charging for parking is a reliable method by which to influence mode choice, and Deer Valley intends to implement paid parking as part of the Snow Park Village proposal. The original Snow Park Village traffic study assumed a reduction in vehicle trips of nearly 18% and applied it to all land uses. This reduction was developed based on approximately 50 studies on the effects of paid parking from across the United States. WCG noted this reduction seemed high based on assumptions about typical Deer Valley clientele and their assumed willingness to pay for fees in addition to lift tickets, meal, lessons, and/or equipment rentals.

Reductions in trip generation due to the implementation of paid parking at Deer Valley have been scaled back to present a more conservative estimate of how parking pricing will affect trip generation. While we agree that some Deer Valley clientele may be much less sensitive to additional costs associated with a day's skiing as presented in the traffic study, almost 45% of existing trips to and from Deer Valley start and end at points along the Wasatch Front, residents of which are more likely to alter their behavior based on willingness to pay (note the massive increase in peripheral on-street parking at a greater distance to ski lifts at Deer Valley's IKON pass-sharing resort, Solitude). Lastly, reductions in trip generation due to the implementation of parking pricing are applied only to the resort hotel-, shopping center-, and recreational community center-generated trips, as proposed residential uses at the site are unlikely to require that residents pay for parking on a daily basis.

## **Trip Internalization Derived from MXD**

A fundamental element of the Snow Park Village proposal is to provide amenities, services, and entertainment options that complement each other and the ski resort itself. This means that peak-hour trips that might occur without complementary land uses are either delayed (so that they do not occur during the peak hours) or do not require a vehicle trip due to proximity of different uses. Trip internalization rates, presented in **Table 1** under the column heading "% Internal Capture" are applied only to the residential-, resort hotel-, and recreational community center-generated trips, and present a more conservative rate of internalization than presented in the original Snow Park Village traffic impact study.



## Trip Internalization Derived from Squaw Valley

While the residential, hotel, and community center uses are expected to be destinations unto themselves that will generate a measurable number of peak-hour vehicle trips, the food service and retail uses (shown in **Table 1** as “Shopping enter”) are expected to almost exclusively serve guests already at Deer Valley rather than guests traveling to Deer Valley explicitly for those services.

To support this assumption, trip generation estimates for the shopping center uses in this memorandum rely on trip internalization estimates derived from an origin-destination survey conducted at the Squaw Valley, California resort in 2011. Surveys conducted showed that 95-97% of customers at dining and retail uses in a similar context (ski resort base village) were already at the village for other purposes, and did not travel solely for the dining/retail use. Reductions based on the data from Squaw Valley are presented under the column heading “% Resort Int. Capt.” And are applied only to the shopping center uses. We assume that employees for these uses will almost exclusively arrive and depart during off-peak periods, resulting in lower reductions for daily trips generated by the shopping center uses.

## Conclusion

Trip generation estimates prepared for the original Snow Park Village traffic impact study were based on an older land use plan, double-counted some reductions in vehicle trips, applied others to incorrect land uses, and over-emphasized the potential reductions in vehicle trips derived from paid parking. However, this memorandum relies on several assumptions that are fundamental to the Snow Park Village proposal:

- Complementary land uses will reduce peak-hour vehicle trips by providing alternatives to driving
- Employees will typically arrive and depart during off-peak periods
- Charging for parking is one of the most powerful tools available for influencing mode choice, relying on an appropriate pricing structure being implemented

The trip generation estimates presented in this memorandum represent a conservative set of analyses that will inform a fully revised traffic impact study for the Snow Park Village Project.



# **Attachment B: Snow Park Village Parking Management Plan**



## MEMORANDUM

Date: January 21, 2022  
To: Rich Wagner, Deer Valley  
From: Fehr & Peers  
Subject: **Snow Park Village MPD Parking Response**

*UT20-2245*

---

The current parking experience at Deer Valley follows a well-established surface parking scenario, typical of ski resorts. There are five large surface lots that hold approximately 1,340 cars. There is also a long-standing agreement with Park City to allow for overflow parking on parts of Deer Valley Drive on peak visitation days.

### Parking Layout

The proposed redevelopment of the base area (Snow Park) will change the parking experience in three significant ways:

- Parking will be in structures;
- There will be a paid parking program, with variable pricing based on season and demand;
- There will be a robust parking management program that includes parking and availability information to visitors as they approach the development, parking garages, and once within, and will rely heavily on Deer Valley's high-quality customer service provided by trained staff.

For phase 1, the proposed parking garages will be on four levels. Each level will have a prescribed function as outlined below. Parking loading will be managed level by level, utilizing guest services staff and electronic messaging. To help ensure that the majority of traffic coming to Snow Park does not conflict with transit on Doe Pass Road, signing, striping, and prominent wayfinding will direct the majority of personal vehicles to use Deer Valley Drive East to enter the garages, while transit and shuttle vehicles will be directed to Deer Valley Drive West and/or Doe Pass Road. The primary entrances to the garages, for levels P2, P3, and P4, will be from Deer Valley Drive East. There are no internal garage connections between levels allowing each level of the garage to serve



as an independent programmable parking resource. The layout and uses are shown in the attached *Parking Allocation* figure.

**P1 Parking** – this level will be divided between two user groups with a total of 406 stalls. Hotel/condo uses will have 202 stalls. The other 204 stalls may be utilized by valet parking and/or credentialed access users. Access to this area is from Doe Pass near the intersection Deer Valley Drive west. Due to its restricted uses, demand for spaces on P1 is expected to be relatively low, with hotel patrons parking vehicles for multiple days at once. In addition, it is unlikely that all hotel patrons will need to park at times that coincide with peak day skier arrival, further reducing the expected number of vehicles on Doe Pass Road during peak hours.

**P2 Parking** – this level will have 368 stalls. It will primarily be used for winter day skiers and summer resort guests during those seasons, transient parking and special event parking during event periods. Access is provided on Deer Valley Drive East, however an auxiliary exit is provided accessing Doe Pass to add flexibility in managing egress and minimize potential congestion during periods of peak parking demand and special events.

**P3 Parking** – the primary users for this level will be similar to P2; day users, transient parking, special event parking as well as space dedicated to ski school drop-off/pick-up. There are 375 stalls for these uses. There are an additional 80 stalls for hotel/condo use, for a total of 455 stalls. Access is primarily to/from Deer Valley Drive, however an auxiliary entrance/exit is provided accessing Deer Valley Drive West/Royal Street intersection, which will be dedicated to hotel and condominium uses.

**P4 Parking** – there are 90 stalls for ski school, valet, and short-term parking on this level. “Short-term” means for visitor parking less than 30 minutes for such purposes as pick-up/drop-off, kiss ‘n’ ride, and so on. The balance of the parking on this level is 41 for hotel/condo uses.

**North Parcel** – The north parcel will consist of an additional 450 stalls. These will initially remain surface parking. This area will eventually consist of two levels, NP1 and NP2, and the total parking stalls will remain at 450. The north parcel will have the same level of parking management, including paid parking, and parking management technology, communications via multiple platforms, and high-touch customer service.

Structured parking layouts are shown below in **Figure 1**.



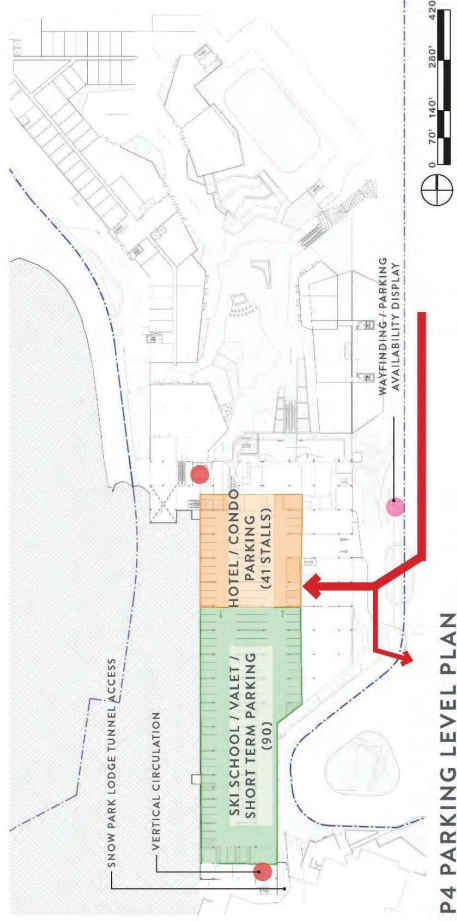
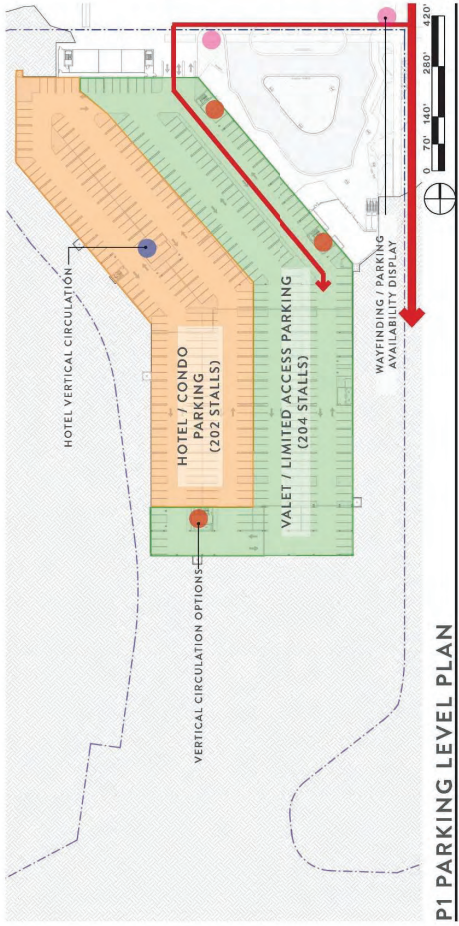

Source: IBI Group



Figure 1  
Parking Level Layouts



## **Paid Parking**

A paid parking scheme will be implemented in a manner that ensures transactions for inbound traffic do not cause delays which could impact adjacent streets. The price will vary by season and is an important tool to encourage all visitors to travel by modes other than driving alone. Signs and parking processes will be designed to maximize efficiency and minimize congestion.

Recognizing that the much of the typical clientele of Deer Valley are less price-sensitive than many potential parkers, pricing may be adjusted following initial implementation to ensure that the preferred reductions in peak parking demand are achieved.

## **Communications**

To achieve the smoothest parking operations possible, parking information will be made available on Deer Valley's website and integrated into any platforms through which ski passes might be purchased. Additionally, hotel and condominium uses will be expected to incentivize arrival options that do not require parking on-site.

Parking availability by level will be integrated into the design of Snow Park. Parking information will be part of the dynamic wayfinding program included in the development. This information will be available to the visitor via electronic messaging at key decision points along Deer Valley Drive East, including at the newly-configured "Y" intersection of Deer Valley Drives East and West, and as the driver approaches the garage entrances. Parking communication may also be integrated into various phone and web apps operated by the resort, city, county, etc.

Once inside the parking levels, parking availability and general internal wayfinding will be incorporated into the design to improve access rates, guiding visitors to available spaces. The exact technologies and vendors have not been determined at this point, but it will employ the most appropriate and technologically advanced parking and transportation systems to ensure an efficient and user-friendly parking experience with minimal impact on adjacent streets.



# **Attachment C: Snow Park Village Transportation Demand Management Plan**



# **Snow Park Village**

## **TDM Plan**

**Prepared for:  
Deer Valley**

July 2022

UT20-2245

**FEHR & PEERS**

## **Table of Contents**

---

1. Project Description and TDM Approach.....	4
1.1 Project Description .....	4
1.2 TDM Approach .....	6
2. Snow Park Village TDM Program .....	8
2.1 Primary TDM measures.....	8
3. Program Monitoring and Adaptation .....	14
3.1 Monitoring Program.....	14
3.1.1 Annual Monitoring Report .....	15

## **Table of Figures**

---

Figure 1: Project Location .....	5
Figure 2: Deer Valley Traveler Origins and Destinations .....	7

*This page intentionally left blank.*

# 1. Project Description and TDM Approach

This Transportation Demand Management (TDM) Plan describes the proposed approach to reduce the total number of vehicle trips at the Snow Park Village project at Deer Valley Resort in Park City, Utah. The Park City Municipal Corporation (PCMC), through its planning department review of the project application, has requested that a standalone TDM Plan be developed for the project. In addition, the City adopted a TDM Plan in 2016 that specifies how the City seeks to reduce vehicle trips through TDM strategies. A reduction in vehicle trips will reduce local pollution, greenhouse gas emissions and improve the quality of life for all who live and work in Park City by reducing vehicle traffic.

This document describes how Deer Valley intends to reduce the number of single-occupancy vehicle (SOV) trips to Snow Park Village using a variety of TDM options. This plan is based heavily on PCMC's existing TDM plan and strategies therein, adopted in August 2016.

Additionally, this plan formalizes TDM offerings that are already provided by Deer Valley to guests and employees for some time. In addition to describing existing offerings, this plan includes new TDM measures to help reduce SOV trips and monitor program effectiveness through ongoing collaboration with PCMC staff and other major destinations in Park City.

## 1.1 Project Description

Snow Park Village proposes to repurpose the existing surface parking lots of the Snow Park base area at Deer Valley Resort for a mixed-use development including hotel, residential, retail and events center uses. Snow Park Village is approximately 1.5 miles from downtown Park City and approximately 2.5 miles from the Park City Mountain Resort base area. Snow Park Village's location in Park City is shown in **Figure 1**.

The bulk of activity at the Snow Park Village is expected to take place during normal business hours. Parking at the site will be priced and include standard and ADA-compliant spaces. Central to the success of the project, a multimodal mobility hub is proposed on Deer Valley Drive, will facilitate non-automobile connections to key destinations in Park City, elsewhere in Summit County, and the Salt Lake Valley. Full build-out of Snow Park Village will include a network of dedicated pedestrian paths within the project, as well as connections to area cycling and pedestrian facilities.



## 1.2 TDM Approach

The success of a TDM program relies on creating a system to manage travel demand that shifts the behavior of those traveling to and from Snow Park from using single occupant vehicles to options other than driving alone. The following sections describe the menu of transportation choices that will make it easier and more convenient to use modes other than driving alone. Through an evaluation of anonymized mobile phone data, provided by a third-party vendor, this Plan has been assembled with the knowledge that a substantial portion of those traveling to and from Deer Valley do so from points around the region. The origins and destinations of Deer Valley's guests and employees are dispersed throughout northern Utah, with the largest share traveling to and from points along the Wasatch Front, as shown in **Figure 2**. This variety of travel patterns requires a robust and diverse program to reduce drive alone trips. A diverse and flexible TDM program will allow Deer Valley to match the transportation services to the travel needs of all traveling to and from Snow Park Village. The TDM Plan described in the following sections supports the project's commitment to managing vehicle traffic to and from Snow Park Village while maintaining flexibility in response to changing travel behavior and regional transportation investments.



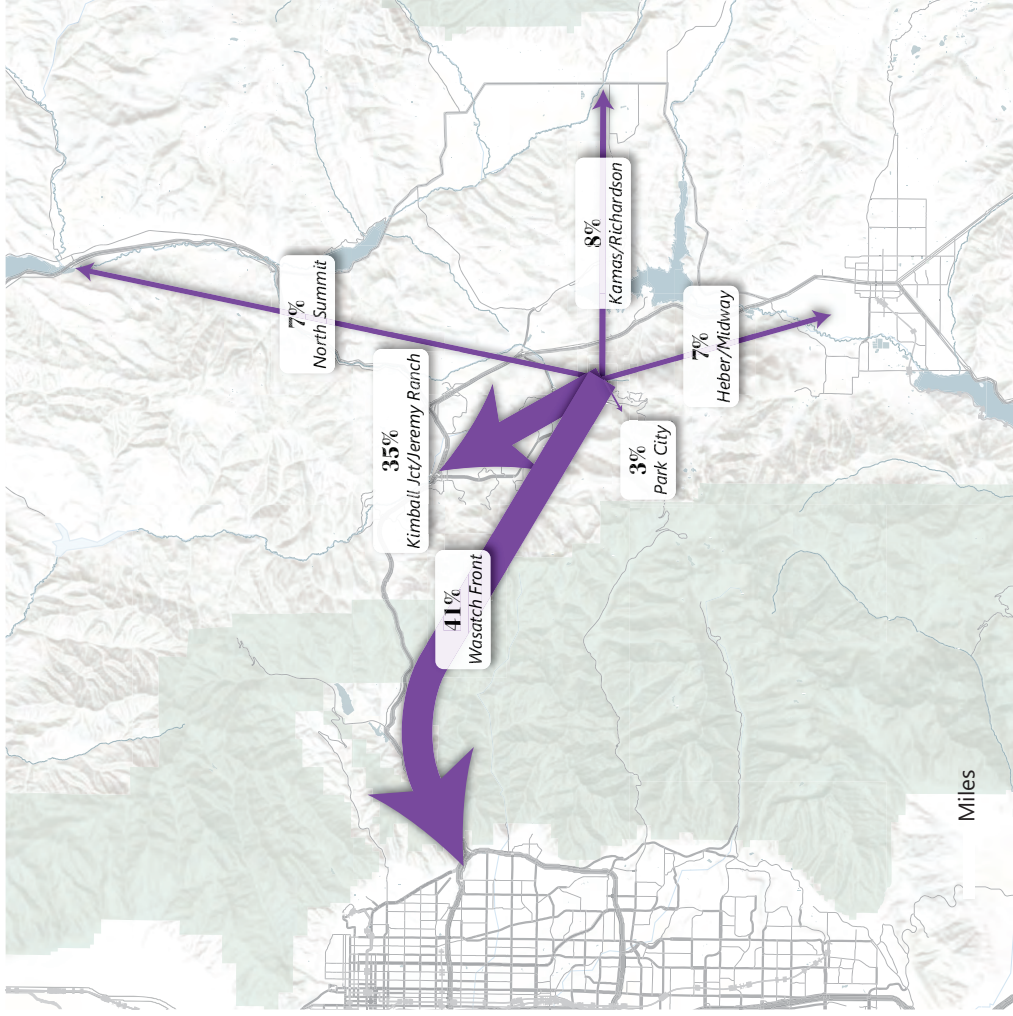
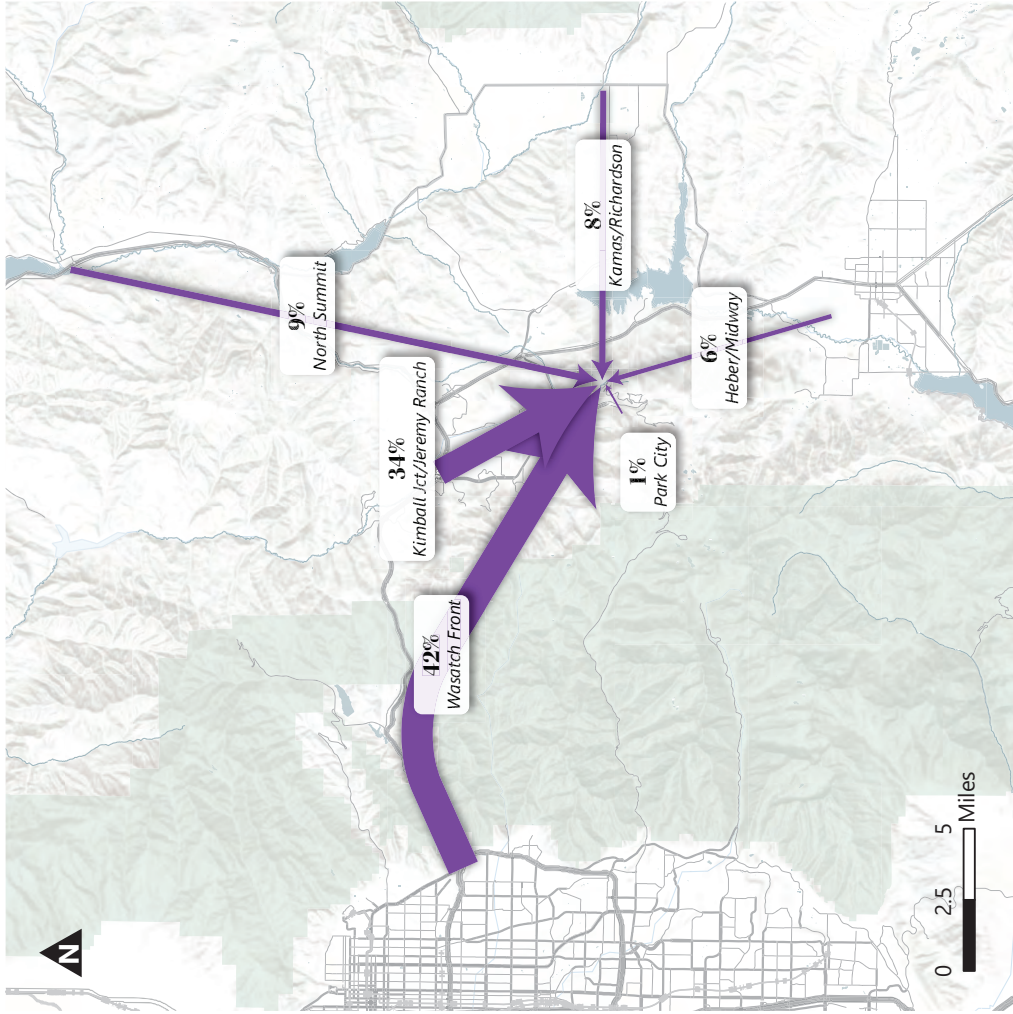

Figure 2  
Deer Valley Origin-Destination AM Incoming - PM Outgoing Trends

## 2. Snow Park Village TDM Program

### 2.1 Primary TDM measures

Deer Valley will provide a variety of opportunities for those traveling to and from Snow Park to choose travel modes that are not driving alone. These are categorized as incentivizing using transit, riding a bicycle, sharing a car, or some combination thereof. A summary of the Primary TDM measures can be found in **Table 1**.

**Table 1: Primary TDM Measures**

Measure	Status	Description
Transit pass subsidy	Existing Program	Subsidized UTA transit passes for Deer Valley employees living in Salt Lake Valley and Utah Valley
Bicycle Amenities and Perks	New Program	Bicycle repair tools and dedicated bicycle parking at key locations
Education and Promotion	Existing Program	Educational and promotional events to encourage travelers to use by modes other than driving alone.
Parking Management	New Program	Efficient, constrained, and priced parking to discourage drive-alone trips
Employee Transit	Existing Program	Operate designated employee transit to facilitate efficient employee commutes through an appealing alternative
Real-Time Messaging	New Program	Communicate traffic conditions in real time to travelers
Appoint a TDM Coordinator	New Program	Identify a staff member to oversee the TDM program

Source: Deer Valley

More detailed descriptions of the Primary TDM Measures can be found below.



To incentivize traveling by bicycle, Deer Valley plans to implement the bicycling-based TDM strategies listed in **Table 2**.

**Table 2: Bicycling and Walking TDM Strategies**

Biking/Walking Strategies	Status	Target User Groups	Description
<b><i>Implement Bicycle Parking at Key Destinations and Transit Stops</i></b>	New Program	Day Guests Commuters Employees	Snow Park Village’s site plan includes the provision of safe and convenient locations to park bicycles, encouraging their use and removing barriers such as frustration in finding secure parking and bicycle theft. This includes the proposed mobility hub on Deer Valley Drive, a key connecting point for trips to and from Snow Park.
<b><i>Expand e-Bike Share</i></b>	New Program	Day Guests Commuters Employees	Snow Park Village will include a relocated PCMC e-bike-share station with direct access to the mobility hub. This will expand coverage of the existing e-bike share service in Park City and enable more non-automobile trips for people traveling to and from Snow Park Village.
<b><i>Install Bicycle Repair Stand</i></b>	New Program	Day Guests Commuters Employees	Deer Valley will install two do-it-yourself bicycle repair stands: one at the proposed mobility hub on Deer Valley Drive, and another seasonal stand at the Silver Lake Express base. The repair stands may include an air pump and basic tools to make minor bicycle repairs. Additional repair options include full-service bike shop(s) during the summer season and on-mountain assistance from Bike Patrol.

Source: Deer Valley

To incentivize traveling by modes other than driving alone, Deer Valley plans to implement the parking-based TDM strategies listed in **Table 3**.

**Table 3: Demand Management TDM Strategies**

Demand Management Strategies	Status	Target User Groups	Description
<b><i>Implement Real-Time Information Messaging</i></b>	New Program	Day Skiers Employees	Deer Valley plans to work with the City, UDOT, and Summit County to deploy VMS boards and other messaging systems at key locations, including approach roads, parking areas, and ski lift bases, to inform those traveling to and from Snow Park Village of current traffic and parking conditions. Additionally, Deer Valley will use its website, social media platforms, and mobile application to notify guests in real time. This will enable

			visitors to make more informed transportation choices allowing for better demand management.
<b>Provide Additional Evening Recreation Opportunities/Amenities:</b>	New Program	Day Skiers Employees Overnight Guests	Providing additional activities, food and beverage options, and/or entertainment for visitors after the ski day has ended is an essential element of the Snow Park Village proposal. Providing opportunities for day skiers to linger at the base area longer will better distribute peak-hour outbound vehicle trips.

Source: Deer Valley

To incentivize traveling by modes other than driving alone, Deer Valley plans to implement the parking-based TDM strategies listed in **Table 4**.

**Table 4: Policy-Based TDM Strategies**

Policy Strategies	Status	Target User Groups	Description
<b>Provide Employee Housing</b>	Existing Program	Employees	Deer Valley has and will continue to provide subsidized housing for its employees in and around Park City. The locations of this housing allow for shorter commutes with access to public transit or shuttles, and increases the likelihood of ridesharing among employees. Any active, full-time staff member is eligible for employee housing. Employee housing is distributed throughout Park City and Heber City in areas that are served by public and employee transit.
<b>Provide Employee Amenities</b>	Existing Program	Employees	Deer Valley employees are able use various on-site amenities that will be provided at Snow Park Village, including employee dining rooms that offer discounted meals, and employee locker rooms that allow for storage of personal items to reduce the need for trips off-site during shift changes and during mealtimes.
<b>Childcare</b>	Existing Program	Day Skiers Employees Overnight Guests	Parents managing childcare are among those who are most attached to private vehicles for personal travel, and providing on-site childcare in the form of both nursery/day care programs, and on-mountain options for active childcare will reduce the need for parents to make multiple local trips and enable their use of non-SOV modes by collocating services. Deer Valley employees are eligible for discounted childcare programs.

Source: Deer Valley

To incentivize traveling by modes other than driving alone, Deer Valley plans to implement the parking-based TDM strategies listed in **Table 5**.

**Table 5: Parking TDM Strategies**

Parking Strategies	Status	Target User Groups	Description
<b><i>Implementation of Efficient Parking Schemes</i></b>	Existing Program	Day Skiers Employees	Deer Valley will continue to assess the need for remote or satellite parking areas for days on which parking demand requires additional capacity beyond that which is provided at the base area itself. The only designated off-site parking location that has been used by Deer Valley is Treasure Mountain Middle School, and is used solely on days of particularly high demand.
<b><i>Implement Parking Demand Management</i></b>	New Program	Day Skiers Employees	A fundamental aspect of Snow Park Village’s proposed parking system is to charge for parking, a direct incentive to those traveling to Deer Valley to more efficiently utilize vehicle capacity, specifically for day skiers. The cost of parking at Snow Park Village will be set at a level that will incentivize higher-occupancy vehicles when traveling to and from Snow Park, a direct disincentive to drive alone. While many Deer Valley patrons are likely less price sensitive to additional charges such as paid parking, available data suggests that a substantial portion of day traffic originates from points along the Wasatch Front, from where patrons are expected to be more price sensitive to parking fees, increasing their likelihood of mode shift.

Source: Deer Valley

To incentivize traveling by modes other than driving alone, Deer Valley plans to implement the programmatic TDM strategies listed in **Table 6**.

**Table 6: Program-Based TDM Strategies**

Programmatic Strategies	Status	Target User Groups	Description
<b><i>Establish a TDM Coordinator</i></b>	New Program	Employees Day Skiers Overnight Guests	Deer Valley will identify an existing staff member to act as the TDM coordinator, a central source for TDM program information. The TDM coordinator may fill many roles, but may be responsible for: real-time messaging of traffic conditions to travelers, distribute information on new or adapted TDM program offerings, and evaluate the effectiveness and use of TDM program elements. The TDM coordinator will also continue to explore new TDM options that best serve Deer Valley guests and/or employees. The TDM coordinator will be the main point of contact with the City and will facilitate communication in connection with the proposed monitoring program. This coordinator will meet with Park City staff on a regular basis to discuss on-going adjustments to the TDM measures.
<b><i>Provide Tailored Information and Promotions</i></b>	Existing Program	Employees Day Skiers Overnight Guests	Deer Valley will develop and distribute targeted messaging and promotions to ensure that different user groups are aware of the TDM measures most relevant to their needs. These promotions may include gamification to further incentivize non-drive alone trips. Deer Valley supports a mobile app used by employees that allows them to organize rides sharing, and identify transit, bike and walking options for their commute. The application also offers incentives to Deer Valley employees for not driving alone to work. Deer Valley will encourage all ski area-serving businesses (namely hotels and other lodging) to further emphasize their transportation offerings that allow guests to rely less on private vehicles and more on shared mobility.

Source: Deer Valley

To incentivize traveling to and from Snow Park by transit, Deer Valley plans to implement the transit-based TDM strategies listed in **Table 7**.

**Table 7: Transit TDM Strategies**

Transit Strategies	Status	Target User Groups	Description
<b><i>Provide Employee Transit</i></b>	Existing Program	Employees	To complement public transit service and supplement in certain areas where public transit may not yet exist, Deer Valley will continue to provide private employee transit to and from Snow Park to allow Deer Valley employees to travel longer distances (such as from Heber City) on employee shuttles. Deer Valley contracts through Le Bus to operate full-sized coach buses for their employees. In a typical (non-Covid) year, Deer Valley provides three AM peak-period and two PM peak-period shuttle runs to serve their employees living in River's Edge and Heber City.
<b><i>Subsidize Transit Passes for Inter-City Commuters</i></b>	Existing Program	Employees	Deer Valley provides subsidized Utah Transit Authority passes to employees commuting to Deer Valley from Utah and Salt Lake Valleys.

Source: Deer Valley

## 3. Program Monitoring and Adaptation

Deer Valley has a strong interest in making trips to and from Snow Park Village as efficient and enjoyable as possible. Doing so is not only a way to improve the overall experience for all who visit Snow Park, but it also allows Deer Valley to contribute to shared goals for reducing traffic impacts within Park City and Summit County.

### 3.1 Monitoring Program

Deer Valley will conduct internal monitoring to best understand how various user groups are getting to Snow Park, how best to improve their experiences, and how to optimize their experience while minimizing their impact on area traffic and the environment. Elements of the TDM program may be adapted, added, or eliminated over time as Deer Valley strives to achieve maximum effectiveness with its TDM program. The Snow Park TDM program will change over time as travel behaviors change and the transportation context around Snow Park evolves.

The TDM coordinator will be responsible for ongoing collaboration and coordination with PCMC staff to ensure that goals are shared and TDM measures managed by Deer Valley are complementing those enacted by the City. To that end, semiannual meetings will take place among Deer Valley, PCMC staff, and other TDM coordinators:

- Prior to each ski season, relevant parties will gather to share relevant updates for the upcoming season, and identify potential opportunities for collaboration, share expectations for the coming months, and discuss performance metrics to be tracked
- Following each ski season, the same parties will meet to share lessons learned and review program performance as recorded by agreed-upon performance metrics, and establish potential action items during the off-season

With ongoing updates to local transit service operated by both Park City Transit and High Valley Transit, Deer Valley will strive to avoid duplication of transit service offerings. Deer Valley's TDM program is intended to support the use of public transit among the public rather than act as an alternative to public transit service. As public transit coverage expands, Deer Valley will adapt its program to support local transit agencies.

### 3.1.1 Annual Monitoring Report

To evaluate the effectiveness of Deer Valley's TDM program, and inform potential adjustments to the program, Deer Valley will develop an annual monitoring report to be submitted to Park City staff for review. Submittal of this report will fall between semi-annual meeting with Park City staff and other TDM program managers in Park City.

To the greatest extent possible, data collected for this monitoring effort will rely on existing or to-be-implemented sources. This will improve consistency across monitoring periods and allow for flexibility around weather or other events if needed.

Deer Valley will collect the following types of data for their TDM monitoring effort:

- Seven-day vehicle counts at all Snow Park Village driveways, to be analyzed and summarized by a third-party consultant. This data will be analyzed and summarized by a third-party consultant
- Average vehicle occupancy collected on one weekday and one weekend day, collected by a third-party vendor or Deer Valley staff, to be analyzed and summarized by a third-party consultant
- Ski season transit ridership, summarized at the stop and daily levels and provided by transit operators, to be analyzed and summarized by a third-party consultant
- Available data regarding program utilization from the *Ride On Park City* platform, to be analyzed and summarized by a third-party consultant

If additional or revised analyses are requested by the City, those requests can be reviewed and possibly scoped in advance of the first monitoring report.