

# Planning Commission Staff Report



PLANNING DEPARTMENT

**Subject:** 115 Sampson Avenue  
**Project #:** PL-18-03794  
**Author:** Anya Grahn, Historic Preservation Planner  
**Date:** June 13, 2018  
**Type of Item:** Administrative – Steep Slope Conditional Use Permit

## Summary Recommendations

Staff recommends the Planning Commission review the application for a Steep Slope Conditional Use Permit (CUP) at 115 Sampson Avenue, conduct a public hearing, and approve the Steep Slope CUP for 115 Sampson Avenue. Staff has prepared findings of fact, conclusions of law, and conditions of approval for the Commission's consideration.

Staff also recommends that the Planning Commission approve a request for a height exception up to 32 feet above Existing Grade to accommodate a single car wide garage in a Tandem Parking configuration, pursuant to [LMC 15-2.2-5\(D\)\(4\)](#) and based on the Findings of Fact, Conclusions of Law, and Conditions of Approval provided herein for the Commission's consideration.

## Description

**Owner/ Applicant:** Silver Potato LLC (Joseph Sponholz and Nancy Bronstein), Architect Jon Degray  
**Location:** 115 Sampson Avenue  
**Zoning:** Historic Residential-Low Density (HRL) District  
**Adjacent Land Uses:** Residential  
**Reason for Review:** Construction of an addition to an existing historic single-family home in excess of 200 square feet of Building Footprint that will be located upon an existing slope of 30% or greater. The Planning Commission is able to approve a height exception for a single car wide garage in a Tandem Parking configuration, per [LMC 15-2.2-5\(D\)\(4\)](#).

## Proposal

This application is a request for a Steep Slope Conditional Use Permit (CUP) for construction of an addition to a historic single-family home, when the Building Footprint of the addition is in excess of 200 square feet if the Building Footprint of the addition is located upon an existing Slope of 30% or greater. The site has been designated as Significant on the Historic Sites Inventory (HSI) and currently has a historic house in the center of the lot. The applicant is proposing to build an addition on the west side of the historic house creating a total house size of 2,697 square feet. The existing footprint of the historic house and its non-historic additions is 772 square feet; the proposed footprint of the house following construction of the addition is 2,004 square feet. The construction is proposed on a slope greater than 30%, and in some areas, the slope is

approximately 60%. Further, the applicant has requested a height exception for a Garage on a Downhill Lot pursuant to [LMC 15-2.2-5\(D\)\(4\)](#).

### **Background**

The current owners purchased this property in February 2010 and began exploring opportunities for redevelopment. They mothballed the existing structure to secure it from vandals, intruders, and the elements in 2011; however, the condition of the structure has continued to decline. In April 2013, the Building Department issued a Notice and Order to Repair the house.

On March 6, 2014, the Park City Council approved the 115 Sampson Avenue Subdivision through [Ordinance 14-07](#); it was recorded on February 26, 2015. At that time, a number of Conditions of Approval were introduced to require a portion of Lots 51 and 52 that include Sampson Avenue to be dedicated to the City, snow storage easements along Sampson Avenue, and an agreement with the City for the parking pad in the existing public right-of-way. The applicant has met this conditions, and, in particular, intends to remove the illegal parking pad as part of the redevelopment of this site.

The owners brought a Historic District Design Review (HDDR) Pre-Application (Pre-app) to the City on April 9, 2013 to discuss options to rehabilitate the historic house and construct a new addition. A full HDDR application was submitted on February 12, 2018; it was deemed complete on February 22, 2018.

On February 12, 2018, the City received an application for a Conditional Use Permit (CUP) for “Construction on a Steep Slope” at 115 Sampson Avenue; the application was deemed complete on February 22, 2018. The property is located in the Historic Residential-Low Density (HRL) District. The lot contains 7,692 square feet. It is a downhill lot.

This application is a request for a Conditional Use Permit (CUP) for construction of a new addition to an existing historic single-family house. Because the proposed footprint of this addition is in excess of 200 square feet and the proposed footprint is located upon an existing slope of greater than 30%, the applicant is required to file a Conditional Use Permit application for review by the Planning Commission, pursuant to Land Management Code (LMC) § 15-2.2-6.

The property is located at 115 Sampson Avenue on a developed lot. The site is designated as Significant on the City’s Historic Sites Inventory (HSI). The Historic Preservation Board (HPB) reviewed and granted the proposed material deconstruction on May 16, 2018 [ [Report \(page 101\)](#)]. The Historic District Design Review (HDDR) application for the proposed renovation of the historic house and construction of the new addition is current under review as it depends on Planning Commission approval of the Steep Slope CUP prior to issuance of a building permit to construct the addition.

## **Purpose**

The purpose of the Historic Residential-Low Density (HRL) District:

- A. reduce density that is accessible only by substandard Streets so these Streets are not impacted beyond their reasonable carrying capacity,
- B. provide an Area of lower density Residential Use within the old portion of Park City,
- C. preserve the character of Historic residential Development in Park City,
- D. encourage the preservation of Historic Structures,
- E. encourage construction of Historically Compatible Structures that contribute to the character and scale of the Historic District, and maintain existing residential neighborhoods.
- F. establish Development review criteria for new Development on Steep Slopes which mitigate impacts to mass and scale and the environment, and
- G. define Development parameters that are consistent with the General Plan policies for the Historic core.

## **Analysis**

Following renovation and construction of the addition, the house will contain a total of 2,697 gross square feet. The proposed footprint of the historic house and its new addition will be 2,004 square feet; the lot size currently allows a footprint of 2,496.28 square feet. The new development complies with all setbacks and building footprint, as outlined in the following table.

This is a downhill lot, and the average slope of the lot is about 52.5%. The slope drops drastically immediately east of Sampson Avenue, with portions of the grade having a slope of about 46.6%. The steepest portion of the lot is directly to the west of the historic house and buries a portion of the historic house that is no longer accessible; this area has a slope of about 60%. Directly east of the historic house and on a portion of the property not proposed to be developed, the slope is about 67% as it abuts two non-historic shed structures. (Please note that a 100% slope would be a 45 degree angle.)

The new construction meets the allowed building height. Staff reviewed the plans and made the following LMC related findings:

<b>Requirement</b>	<b>LMC Requirement</b>	<b>Proposed</b>
Lot Size	Minimum of 3,750 square feet	7,692 square feet, <u>complies.</u>
Building Footprint	2,496 square feet maximum based on existing lot area	2,004 square feet, <u>complies.</u>
Front Yard	15 feet minimum, total of 30 feet	15 feet, <u>complies</u>
Rear Yard	15 feet minimum, total of 30 feet	15 feet, <u>complies</u>
Side Yard	10 feet minimum, 20 feet total	10 feet, 20 feet total, <u>complies.</u>
Height	27 feet above existing grade, maximum.	25.4 feet, <u>complies.</u>

Height Exception for Garage on a Downhill Lot + Circulation	35 feet above existing grade, maximum.	32 feet, <u>complies.</u>
Interior Height	A Structure shall have a maximum height of 35 feet measured from the lowest finish floor plane to the point of the highest wall top plate that supports the ceiling joists or roof rafters.	34 feet, <u>complies.</u>
Final grade	Final grade must be within four (4) vertical feet of existing grade around the periphery of the structure.	Maximum difference on the east (rear) yard is 4 feet. New exterior stairs will be constructed within 30" of Final Grade, <u>complies.</u>
Vertical articulation	<p>A ten foot (10') minimum horizontal step in the downhill façade is required unless the First Story is located completely under the finish Grade on all sides of the Structure.</p> <p>The horizontal step shall take place at a maximum height of twenty three feet (23') from where Building Footprint meets the lowest point of existing Grade. Architectural features, that provide articulation to the upper story façade setback may encroach into the minimum 10 ft. setback but shall be limited to no more than 25% of the width of the building encroaching no more than 4 ft. into the setback.</p>	There is a 10 foot horizontal step in the downhill façade that is provided by the historic house before it extends into the addition, <u>complies.</u>
Roof Pitch	Between 7:12 and 12:12.	The main roof of the addition has a 12:12 and 7:12 pitch, <u>complies.</u>
Parking	Per LMC 15-2.2-4, Historic Structures that do not comply with Building Footprint, Building Height, Building Setbacks, Off-Street parking, and driveway location standards are valid Complying Structures. Additions to Historic Structures are exempt from Off-Street parking requirements provided the addition does not create a Lockout Unit or an Accessory Apartment. Additions must comply with Building Setbacks, Building Footprint, driveway location standards and Building Height.	The applicant proposes to provide one off-street parking space outside, in tandem configuration to the one-car garage (off-street parking for 2 cars total provided)

*\*Per LMC 15-2.2-4 Historic Structures that do not comply with Building Footprint, Building Height, Building Setbacks, Off-Street parking, and driveway location standards are valid Complying Structures.*



### Building Height Exception for Garage on a Downhill Lot

Pursuant to [LMC 15-2.1-5\(D\)\(4\)](#), the Planning Commission may allow additional Building Height (see entire Section 15-2.1-5) on a downhill Lot when certain criteria are met. Staff has provided these criteria in the following table and demonstrated how it is met:

<b>LMC Requirement for Garage on a Downhill Lot</b>	<b>Proposed:</b>
To accommodate a single car wide garage in a Tandem Parking configuration	The applicant has provided parking in a tandem configuration—1 uncovered 9 ft. by 18 ft. parking space on the exterior tandem to a 1-car garage measuring 12 ft. by 20.5 ft.; <b><i>complies</i></b>
To accommodate circulation, such as stairs and/or an ADA elevator; and to accommodate a reasonably sized front entry area and front porch that provide a Compatible streetscape design.	Applicant is proposing a 210 square foot circulation space containing stairs and an elevation. A front porch has been added to the façade; <b><i>complies.</i></b>
The depth of the garage may not exceed the minimum depth for internal Parking Space(s) as dimensioned within this Code, Section 15-3.	Minimum depth required is 11 ft. by 20 ft.; the applicant’s garage measures 12 ft. by 20.5 ft; <b><i>complies.</i></b>
The additional Building Height may not exceed thirty-five feet (35’) from Existing Grade.	Applicant is proposing 32 feet above Existing Grade; <b><i>complies.</i></b>

The applicant is requesting a 5 foot height exception for the garage on a downhill lot, for a height of 32 feet above Existing Grade. This height exception would apply to only the maximum building height as the applicant does not need a height exception for the interior height. The HRL zone allows a maximum building height of 27 feet from existing grade and a maximum interior height of 35 feet from the lowest finish floor plane to the point of the highest wall top plate. The exception would only increase the exterior height of the building to 32 feet above Existing Grade for the garage and circulation space.

The applicant is proposing a single-car garage with an uncovered, exterior parking space in a tandem configuration. The interior dimensions of the garage are 12 feet by 20.5 feet, which is consistent with the requirements of [LMC 15-3-4\(A\)\(1\)](#). A second uncovered exterior parking space measuring 9 feet by 18 feet has been provided in the driveway and within the property lines of this site. A new circulation space of approximately 210 square feet is attached to this space; this space contains a staircase that wraps around an elevator. A front door on the façade will emphasize the pedestrian entrance and create a street presence for this house. The garage and circulation space are the only areas that are included in the height exception. All other areas of the house shall meet the standard HRL height requirements.

### **Steep Slope Conditional Use Permit**

The property is located outside the Park City Landscaping and Maintenance of Soil Cover Ordinance (Soils Ordinance) and therefore not regulated by the City for mine related impacts. If the property owner does encounter mine waste or mine waste impacted soils they must handle the material in accordance to State and Federal law. Staff has included this as Condition of Approval #8.

LMC § 15-2.1-6(A)(2) requires a Steep Slope Conditional Use Permit (CUP) for construction of any new construction when the Building Footprint of the addition is in excess of 200 square feet, if the building of the footprint is located upon an existing slope of 30% or greater. As previously noted, the historic house and new addition will have a total footprint of 2,004 square feet and the construction is proposed on a slope that varies from 46 to 60%, east of Sampson Avenue.

#### Criteria 1: Location of Development.

Development is located and designed to reduce visual and environmental impacts of the Structure. **No unmitigated impacts.**

*The proposed single family dwelling is located on the lot in a manner that reduces the visual and environmental impacts. The historic house will remain in its existing location, which is most visible from Norfolk Avenue and almost hidden from view along Sampson Avenue due to the location of the historic house downhill from the right-of-way. The applicant is proposing to construct an addition to the west (rear) side of the house, which will appear as a small, one-story addition with a pedestrian entrance and single-car garage along Sampson Avenue. The addition will have a total of three stories. The hillside rises steeply at the back portion of the house, so that much of the proposed bulk and mass of the new addition will be buried in the hillside. A series of terraced, landscaped outdoor living spaces will further limit the view of the new addition.*

*Due to the placement of the historic house on the lot, the only logical location for the addition is behind the historic house. The location of the historic house prevents a side addition from being constructed as it could not comply with the required setbacks. Because the canyon wall rises steeply directly behind the historic house, the back half of the addition will be constructed on one of the steepest portions of the lot, and will be undisturbed to the east (and above) the new addition.*

*The proposed addition will comply with the Design Guidelines and add to the character of the street. Currently, there is an unsafe parking pad along Sampson Avenue that is supported by railroad ties. This dangerous parking pad will be removed and the hillside restored as part of the site's redevelopment.*

#### Criteria 2: Visual Analysis.

The Applicant must provide the Planning Department with a visual analysis of the project from key Vantage Points to determine potential impacts of the project and identify potential for screening, slope stabilization, erosion mitigation, vegetation protection, and other items. **No unmitigated impacts.**

*The applicant submitted a photographic visual analysis, including street views, to show the proposed streetscape and cross canyon views. As demonstrated by the visual*

*analysis, the proposed addition fits within the context of the slope, neighboring structures, and existing vegetation. The neighborhood consists of historic houses with one- to two-story additions, one- to two-story new houses, and a few three- to four-story new residential developments.*

*The historic house is not visible from Sampson Avenue as it sits approximately 30 feet below the street. Because the house was constructed to face west, towards town, the best view of the historic façade is from Norfolk Avenue. The applicant has designed the addition so that it steps up the hillside, providing pedestrian and vehicular access to Sampson Avenue. Not only will this alleviate some of the dangerous site conditions that exist with the railroad tie-supported parking pad, it will also create a presence along Sampson Avenue where it is currently difficult to determine which staircase accesses this property.*

*The visual analysis, streetscape, and cross canyon view demonstrate that the proposed design is visually compatible with the neighborhood, similar in scale and mass to surrounding structures, and visual impacts are mitigated. By stepping the structure up the hill, the mass and scale have been broken up and largely minimized. The side yard will be re-vegetated following construction. New stacked stone retaining walls will provide planting beds as they step down the hill from the new garage addition. Further, the terraces will create new outdoor living spaces. These terraces are not supposed to change grade by more than 4 feet. Additional vegetation called out in the applicant's landscape plan will further mitigate views of and separate the house from neighboring properties.*

*There is currently no Mature Vegetation identified on this property. The applicant is proposing a robust landscape plan that will visually buffer and screen the view of the house from neighboring properties as well as the street. The street view of the house is simple in design and creates vehicular and pedestrian access to the property from Sampson Avenue.*

### Criteria 3: Access.

Access points and driveways must be designed to minimize Grading of the natural topography and to reduce overall Building scale. Common driveways and Parking Areas, and side Access to garages are strongly encouraged. **No unmitigated impacts.**

*The existing access to this property from Sampson Avenue is poor. There is an existing 1983 parking pad in the center of the site that is supported by a railroad tie wall. A series of wooden staircases installed between 1970 and 1995 have deteriorated into a rickety condition.*

*The applicant is proposing to remove the parking pad that encroaches into the City right-of-way. This parking pad was never intended to provide public parking, but was built by previous owners of 115 Sampson Avenue to provide parking for their site. Additionally, as part of the plat amendment that was recorded in 2015, an Encroachment Agreement between Park City Municipal Corporation and Silver Potato LLC (the current owners), requiring the owners to maintain the parking pad.*

*The applicant proposes to remove the parking pad in order to construct a new addition along the street. The addition will meet the required 15 foot front yard setback; the applicant is proposing a 15 foot setback. A new driveway will be constructed connecting the one-car garage and pedestrian entrance to the street. On-site parking will be provided within the driveway and one-car garage.*

#### Criteria 4: Terracing.

The project may include terraced retaining Structures if necessary to regain Natural Grade. **No unmitigated impacts.**

*The hillside will need to be re-graded following the demolition of the 1983 parking pad to restore original grade. Following construction of the addition, the applicant is proposing to terrace the hillside in order to create a series of outdoor patios and living spaces. There are seven proposed retaining walls; of these, three of the walls are no more than 4 feet in height and four of the walls are 2.5 feet. The terraces and setback areas will be landscaped to provide a visual separation and help mitigate the appearance of the new addition. These proposed terraces do not change the grade more than 4 feet around the perimeter of the structure.*

#### Criteria 5: Building Location.

Buildings, access, and infrastructure must be located to minimize cut and fill that would alter the perceived natural topography of the Site. The Site design and Building Footprint must coordinate with adjacent properties to maximize opportunities for open Areas and preservation of natural vegetation, to minimize driveway and Parking Areas, and provide variation of the Front Yard. **No unmitigated impacts.**

*The structure has been designed in order to be setback and visually separated from the historic house at the front of the lot. It will add to the character of the street by creating pedestrian and vehicular access to the site. The addition to the historic house has been designed to step up the hill. The location of this addition was largely driven by the need to access Sampson Avenue and the façade of the house facing east, opposite the road.*

*The applicant has sited the new addition in such a way that the original grade of the site can be largely restored following the deconstruction of the 1983 parking pad. Several terraces will extend from the front yard to the flatter portion of the lot where the historic house sits. The design has maximized opportunities for open space, and there is no Significant Vegetation to preserve as the site is overgrown. New landscaping will be incorporated to help maintain the hillside and provide visual separations from the neighboring properties. New trees and shrubs in the front yard setback will limit the appearance of the new addition from the Sampson Avenue right-of-way, while additional trees and lawn on the lower level near the house will shield the house from view from the neighbors.*

#### Criteria 6: Building Form and Scale.

Where Building masses orient against the Lot's existing contours, the Structures must be stepped with the Grade and broken into a series of individual smaller components that are Compatible with the District. Low profile Buildings that orient with existing contours are strongly encouraged. The garage must be subordinate in design to the

main Building. In order to decrease the perceived bulk of the Main Building, the Planning Commission may require a garage separate from the main Structure or no garage. **No unmitigated impacts.**

*Staff finds that the building mass of the new addition is consistent with the existing historic house. The new addition provides a visual transition between the historic house and the new addition. The mass of the addition steps up the hill, terminating at Sampson Avenue. This helps breakup the mass of the structure, and the tallest portions of the historic house are set back substantially from the historic house so as not to detract from it. The historic house, when viewed from the Norfolk Avenue right-of-way that it faces, will remain the focal point of the project.*

*Staff finds that the proposed design is consistent with the Design Guidelines for Historic Districts and Historic Sites. The new addition begins on the shallower sloped part of the lot, but then climbs the hillside towards the back (west) until it reaches Sampson Avenue. The structure reflects the historic character of Park City's Historic Sites such as simple building forms, unadorned materials, and restrained ornamentation. The style of architecture selected and all elevations of the building are designed in a manner consistent with a contemporary interpretation of the chosen style.*

*Exterior elements of the new development—roofs, entrances, eaves, porches, windows, doors, steps, retaining walls, garages, etc.—are of human scale and are compatible with the neighborhood and the style of architecture selected. The scale and height of the new structure follows the predominant pattern of the neighborhood which is comprised of one- and two-story buildings as well as historic houses with two-story additions in the back. Further, the style of this house is consistent with the Design Guidelines. This building is challenged by having two facades—the most publically visible one along Sampson Avenue and the historic façade of the house that faces east towards Norfolk Avenue. The design proposed has provided street presence along Sampson Avenue with a one-car garage and pedestrian entrance. From the street, the addition appears to be only one story in height.*

#### Criteria 7: Setbacks.

The Planning Commission may require an increase in one or more Setbacks to minimize the creation of a “wall effect” along the Street front and/or the Rear Lot Line. The Setback variation will be a function of the Site constraints, proposed Building scale, and Setbacks on adjacent Structures. **No unmitigated impacts.**

*The new addition is largely tucked behind the historic house and only appears as one-story in height from the Sampson Avenue right-of-way. It does not create a wall effect along the Street front or appear to overwhelm the historic house. It is visually separated from the historic house by a transitional element, and the taller masses are pushed back toward Sampson Avenue so they do not overwhelm the historic house.*

#### Criteria 8: Dwelling Volume.

The maximum volume of any Structure is a function of the Lot size, Building Height, Setbacks, and provisions set forth in this Chapter. The Planning Commission may further limit the volume of a proposed Structure to minimize its visual mass and/or to

mitigate differences in scale between a proposed Structure and existing Structures. **No unmitigated impacts.**

*The proposed design is articulated and broken into compatible massing components. The design includes setback variations and lower building heights for portions of the structure. The proposed massing and architectural design components are compatible with both the volume and massing of single family dwellings in the area. The design minimizes the visual mass and mitigates the differences in scale between the proposed house and surrounding structures.*

#### Criteria 9: Building Height (Steep Slope).

The maximum Building Height in the HR-1 District is twenty-seven feet (27'). The Planning Commission may require a reduction in Building Height for all, or portions, of a proposed Structure to minimize its visual mass and/or to mitigate differences in scale between a proposed Structure and existing residential Structures. **No unmitigated impacts.**

*The proposed new construction meets the twenty-seven feet (27') maximum building height requirement measured from existing grade; however, the applicant has requested a building height exception for the garage and circulation space pursuant to [LMC 15-2.1-5\(D\)\(4\)](#). The height of the new addition is approximately 32 feet above existing grade, and the remainder of the addition becomes buried in the hillside as the grade steps uphill towards the rear of the lot to comply with the 27 foot height requirement. The roof has been designed to allow for a front and side-facing gables along the street front, consistent with adjacent structures. As designed the house is compatible in mass and scale with houses in the surrounding neighborhood. If anything, the size of this house will appear much smaller than its neighbors from the street because only a pedestrian entrance and garage will be visible from the street front.*

#### Process

Approval of this application constitutes Final Action that may be appealed to the City Council following appeal procedures found in LMC § 15-1-18. The applicant has submitted a Historic District Design Review (HDDR) application. The Historic District Design Review (HDDR) application for the proposed renovation of the historic house and construction of the new addition was approved on May 23, 2017, with Conditions of Approval that required the plat amendment to be recorded and Planning Commission approval of the Steep Slope CUP prior to issuance of a building permit to construct the addition

#### Department Review

This project has gone through an interdepartmental review. The Building Department informed staff that they will require a six foot chain-link fence around the property and parking will not be allowed on Sampson, King Road or Norfolk Ave. They will need to submit a detailed parking plan when and if the project advances. This has been reflected in Condition of Approval #9.

## **Notice**

The property was posted and notice was mailed to property owners within 300 feet on May 30, 2018. Legal notice was also published in the Park Record in accordance with requirements of the LMC on May 26, 2018.

## **Public Input**

No input has been received regarding the Steep Slope CUP. Public comment was taken as part of the HDDR public hearing, and the neighbors expressed concerns about the loss of the parking pad as well as construction mitigation and parking along Sampson Avenue.

## **Alternatives**

- The Planning Commission may approve the Conditional Use Permit for 243 Daly Avenue as conditioned or amended, or
- The Planning Commission may deny the Conditional Use Permit and provide staff with Findings for this decision, or
- The Planning Commission may request specific additional information and may continue the discussion to a date uncertain.

## **Significant Impacts**

As conditioned, there are no significant fiscal or environmental impacts from this application. The lot is an existing platted, developed residential lot that contains an existing historic house and landscaping consisting of native grasses and shrubs, as well as several large evergreen trees.

## **Consequences of not taking the Suggested Recommendation**

The construction as proposed could not occur and the applicant would have to revise the plans.

## **Recommendation**

Staff recommends the Planning Commission review the application for a Steep Slope Conditional Use Permit at 243 Daly Avenue and conduct a public hearing. Staff has prepared findings of fact, conclusions of law, and conditions of approval for the Commission's consideration.

## **Findings of Fact:**

1. The property is located at 115 Sampson Avenue.
2. The site is located in the Historic Residential-Low Density (HRL) Zoning District.
3. The site is designated as "Significant" on the City's Historic Sites Inventory.
4. The lot contains 7,692 square feet. It is a downhill lot.
5. On March 6, 2014, the Park City Council approved the 115 Sampson Avenue Subdivision through Ordinance 14-07; it was recorded on February 26, 2015.
6. This application is a request for a Steep Slope Conditional Use Permit (CUP) for construction of an addition to a historic single-family home, when the Building Footprint of the addition is in excess of 200 square feet if the Building Footprint of the addition is located upon an existing Slope of 30% or greater.
7. The applicant is proposing to build an addition on the west side of the historic house creating a total house size of 2,697 square feet.



8. The existing footprint of the historic house and its non-historic additions is 772 square feet; the proposed footprint of the house following construction of the addition is 2,004 square feet. The lot size currently allows a footprint of 2,496.28 square feet.
9. On February 12, 2018, the City received an application for a Conditional Use Permit (CUP) for "Construction on a Steep Slope" at 115 Sampson Avenue; the application was deemed complete on February 22, 2018.
10. This is a downhill lot, and the average slope of the lot is about 52.5%. The slope drops drastically immediately east of Sampson Avenue, with portions of the grade having a slope as much as 67%.
11. Pursuant to LMC 15-2.4-5(D)(4), the Planning Commission may allow additional Building Height (see entire Section 15-2.1-5) on a downhill Lot to accommodate a single car wide garage in a Tandem Parking configuration; to accommodate circulation, such as stairs and/or an ADA elevator; and to accommodate a reasonably sized front entry area and front porch that provide a Compatible streetscape design. The applicant is proposing tandem parking consisting of a single-car garage (approximately 246 square feet) and uncovered parking space in the driveway as well as a circulation space containing a staircase and elevator (approximately 210 square feet). The depth of the garage will not exceed the minimum depth for internal Parking Spaces as required within LMC 15-3; the applicant has provided a garage 20 feet in depth. The additional Building Height is not permitted to exceed 35 feet Existing Grade; the proposed height is 32 feet above Existing Grade.
12. The property is located outside the Park City Landscaping and Maintenance of Soil Cover Ordinance (Soils Ordinance) and therefore not regulated by the City for mine related impacts.
13. The development has been located and designed to reduce visual and environmental impacts of the Structure. The historic house will remain in its existing location, which is most visible from Norfolk Avenue and almost hidden from view along Sampson Avenue due to the location of the historic house downhill from the right-of-way. The applicant is proposing to construct an addition to the west (rear) side of the house, which will appear as a small, one-story addition with a pedestrian entrance and single-car garage along Sampson Avenue. The addition will have a total of three stories. Much of the proposed bulk and mass of the new addition will be buried in the hillside.
14. The proposal minimizes impacts of the project by incorporating screening, slope stabilization, erosion mitigation, vegetation protection, and other items. As demonstrated by the visual analysis, the proposed addition fits within the context of the slope, neighboring structures, and existing vegetation. The neighborhood consists of historic houses with one- to two-story additions, one- to two-story new houses, and a few three- to four-story new residential developments. The applicant has designed the addition so that it steps up the hillside, providing pedestrian and vehicular access to Sampson Avenue. Not only will this alleviate some of the dangerous site conditions that exist with the railroad tie-supported parking pad, it will also create a presence along Sampson Avenue where it is currently difficult to determine which staircase accesses this property.
15. Access points and driveways have been designed to minimize grading of the natural topography and reduce overall building scale. The applicant is proposing to remove the existing railroad-tie parking pad that encroaches into the City right-of-way and

replace it with a new driveway and single-car garage. This parking pad was never intended to provide public parking, but was built by previous owners of 115 Sampson Avenue to provide parking for their site. Additionally, as part of the plat amendment that was recorded in 2015, an Encroachment Agreement between Park City Municipal Corporation and Silver Potato LLC (the current owners), requiring the owners to maintain the parking pad.

16. The project includes retaining walls and terraces to retain Natural Grade. The hillside will need to be re-graded following the demolition of the 1983 parking pad to restore original grade. Following construction of the addition, the applicant is proposing to terrace the hillside in order to create a series of outdoor patios and living spaces. There are seven proposed retaining walls; of these, three of the walls are no more than 4 feet in height and four of the walls are 2.5 feet.
17. Buildings, access, and infrastructure must be located to minimize cut and fill that would alter the perceived natural topography of the Site. The structure has been designed in order to be setback and visually separated from the historic house at the front of the lot. The applicant has sited the new addition in such a way that the original grade of the site can be largely restored following the deconstruction of the 1983 parking pad. Several terraces will extend from the front yard to the flatter portion of the lot where the historic house sits. The design has maximized opportunities for open space, and there is no Significant Vegetation to preserve as the site is overgrown. New landscaping will be incorporated to help maintain the hillside and provide visual separations from the neighboring properties.
18. Where Building masses orient against the Lot's existing contours, the Structures must be stepped with the Grade and broken into a series of individual smaller components that are Compatible with the District. The new addition provides a visual transition between the historic house and the new addition. The mass of the addition steps up the hill, terminating at Sampson Avenue. This helps breakup the mass of the structure, and the tallest portions of the historic house are set back substantially from the historic house so as not to detract from it. The historic house, when viewed from the Norfolk Avenue right-of-way that it faces, will remain the focal point of the project.
19. The proposal minimizes the creation of a "wall effect" along the Street front. The new addition is largely tucked behind the historic house and only appears as one-story in height from the Sampson Avenue right-of-way. It does not create a wall effect along the Street front or appear to overwhelm the historic house. It is visually separated from the historic house by a transitional element, and the taller masses are pushed back toward Sampson Avenue so they do not overwhelm the historic house.
20. The volume of the structure has been restrained to minimize its visual mass and mitigate differences between the scale of the historic house and new addition. The proposed design is articulated and broken into compatible massing components. The design includes setback variations and lower building heights for portions of the structure. The proposed massing and architectural design components are compatible with both the volume and massing of single family dwellings in the area. The design minimizes the visual mass and mitigates the differences in scale between the proposed house and surrounding structures.
21. The proposed new construction meets the twenty-seven feet (27') maximum building height requirement measured from existing grade; however, the applicant has

requested a building height exception for the garage and circulation space pursuant to LMC 15-2.1-5(D)(4), The height of the new addition is approximately 32 feet above existing grade, and the remainder of the addition becomes buried in the hillside as the grade steps uphill towards the rear of the lot to comply with the 27 foot height requirement. The roof has been designed to allow for a front and side-facing gables along the street front, consistent with adjacent structures. As designed the house is compatible in mass and scale with houses in the surrounding neighborhood.

22. The property was posted and notice was mailed to property owners within 300 feet on May 30, 2018. Legal notice was also published in the Park Record in accordance with requirements of the LMC on May 26, 2018.
23. The findings in the Analysis section of this report are incorporated herein.

### **Conclusions of Law**

1. The CUP, as conditioned, is consistent with the Park City Land Management Code, specifically section 15-2.1-6.
2. The Use is consistent with the Park City General Plan, as amended.
3. The effects of any differences in use or scale have been mitigated through careful planning.

### **Conditions of Approval**

1. All Standard Project Conditions shall apply.
2. City approval of a construction mitigation plan is a condition precedent to the issuance of any building permits. The CMP shall include language regarding the method of protecting adjacent structures.
3. City Engineer review and approval of all lot grading, utility installations, public improvements and drainage plans for compliance with City standards is a condition precedent to building permit issuance.
4. This approval will expire on June 13, 2019, if a building permit has not been issued by the building department before the expiration date, unless an extension of this approval has been requested in writing prior to the expiration date and is granted by the Planning Director.
5. Plans submitted for a Building Permit must substantially comply with the plans reviewed and approved by the Planning Commission on June 13, 2018, and the Final HDDR Design.
6. Modified 13-D residential fire sprinklers are required for all new construction on this lot.
7. All excavation work to construct the foundation of the new addition shall start on or after April 15<sup>th</sup> and be completed on or prior to October 15<sup>th</sup>. The Planning Director may make a written determination to extend this period up to 30 additional days if, after consultation with the Historic Preservation Planner, Chief Building Official, and City Engineer, determines that it is necessary based upon the need to immediately stabilize an existing Historic property, or specific site conditions such as access, or lack thereof, exist, or in an effort to reduce impacts on adjacent properties.
8. The property is located outside the Park City Landscaping and Maintenance of Soil Cover Ordinance (Soils Ordinance) and therefore not regulated by the City for mine related impacts. If the property owner does encounter mine waste or mine waste

impacted soils they must handle the material in accordance to State and Federal law.

9. During construction, a six foot chain-link fence around the property will be required. The Construction Mitigation Plan should note that parking will not be allowed on Sampson, King Road or Norfolk Ave. The applicant will need to submit a detailed parking plan when as part of their Construction Mitigation Plan.

**Exhibits**

Exhibit A- Existing Conditions Survey

Exhibit B- Plans (existing conditions, site plan, elevations, floor plans)

Exhibit C- Visual Analysis/Streetscape

# Exhibit A

## SURVEYOR'S CERTIFICATE

I, John Demkowicz, do hereby certify that I am a registered land surveyor in the State of Utah. I am duly licensed and qualified to practice my profession. I have personally supervised the work shown on this map and the same has been made under my direction of the lands shown and described hereon. I have caused to be made a true and correct representation of the land surveyed at the time the field work was completed and is in compliance with generally accepted industry standards for accuracy.



## NOTES

1. Site Benchmarks: Water meter in Sampson Avenue  
Elevation=7299.2'
2. The architect is responsible for verifying building setbacks, zoning requirements and building heights.
3. This topographic map is based on a field survey performed on July 24, 1998 and updated on July 28, 2006 and November 16, 2007.
4. See recorded survey S-6148.

LINE	BEARING	DISTANCE
1,2	S 103°32'00" E	17.330'
3,4	S 103°32'00" E	17.330'



 <p style="font-size: 8px;">(435) 548-3447 COURTESY: ANNE/STEELE LAND PLANNERS ARCHITECTS 227 Main Street, P.O. Box 1984, Park City, Utah 84302-1984</p>	<p style="font-size: 8px;"><b>STAFF:</b> MARSHALL KING BLAKE WITERS CRIP TONGUE</p>	<p style="font-size: 8px;"><b>EXISTING CONDITIONS</b> 115 SAMPSON AVENUE BLOCK 78, PARK CITY SURVEY FOR: GERMAINE PARTNERS JOB NO.: 3-1-08 FILE: X:\ParkCitySurvey\img\lwp\lwp2008\030108.dwg</p>	<p style="font-size: 8px;"><b>SHEET</b> 1 OF 1</p>
<p style="font-size: 8px;"><b>DATE:</b> 1/17/08</p>			

WALL TYPES

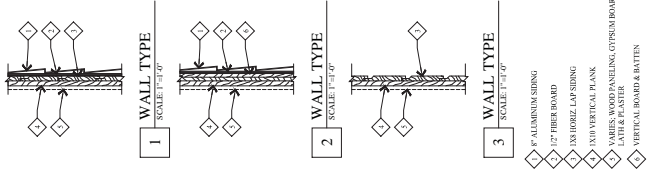

KEY NOTES

- 1. GAS METER
- 2. ELECTRICAL METER
- 3. SHIPS LAUNDER
- 4. STOVE
- 5. BRICK MASONRY CHIMNEY
- 6. ELECTRICAL BREAKER BOX
- 7. STANDING SEAM METAL ROOF ON WOOD SHAKES
- 8. 2x4 JOIST IN GABLE END ON 2x4 FLOOR JOIST
- 9. 2x4 JOIST IN GABLE END ON 2x4 FLOOR JOIST
- 10. WOOD SHAKE SHINGLES IN PLANK ON 2x4 JOIST
- 11. 2x4 JOIST IN GABLE END ON 2x4 FLOOR JOIST
- 12. ALUMINUM SIDING ON 1/2" FIBER BOARD ON 1/2" FIBER BOARD
- 13. 1/2" FIBER BOARD ON 1/2" FIBER BOARD
- 14. 1/2" FIBER BOARD ON 1/2" FIBER BOARD
- 15. 1/2" FIBER BOARD ON 1/2" FIBER BOARD
- 16. 1/2" FIBER BOARD ON 1/2" FIBER BOARD
- 17. 1/2" FIBER BOARD ON 1/2" FIBER BOARD
- 18. 1/2" FIBER BOARD ON 1/2" FIBER BOARD
- 19. 1/2" FIBER BOARD ON 1/2" FIBER BOARD
- 20. 1/2" FIBER BOARD ON 1/2" FIBER BOARD
- 21. 1/2" FIBER BOARD ON 1/2" FIBER BOARD
- 22. 1/2" FIBER BOARD ON 1/2" FIBER BOARD
- 23. 1/2" FIBER BOARD ON 1/2" FIBER BOARD
- 24. 1/2" FIBER BOARD ON 1/2" FIBER BOARD
- 25. 1/2" FIBER BOARD ON 1/2" FIBER BOARD
- 26. 1/2" FIBER BOARD ON 1/2" FIBER BOARD
- 27. 1/2" FIBER BOARD ON 1/2" FIBER BOARD
- 28. 1/2" FIBER BOARD ON 1/2" FIBER BOARD
- 29. 1/2" FIBER BOARD ON 1/2" FIBER BOARD
- 30. 1/2" FIBER BOARD ON 1/2" FIBER BOARD
- 31. 1/2" FIBER BOARD ON 1/2" FIBER BOARD
- 32. 1/2" FIBER BOARD ON 1/2" FIBER BOARD
- 33. 1/2" FIBER BOARD ON 1/2" FIBER BOARD
- 34. 1/2" FIBER BOARD ON 1/2" FIBER BOARD
- 35. 1/2" FIBER BOARD ON 1/2" FIBER BOARD
- 36. 1/2" FIBER BOARD ON 1/2" FIBER BOARD
- 37. 1/2" FIBER BOARD ON 1/2" FIBER BOARD
- 38. 1/2" FIBER BOARD ON 1/2" FIBER BOARD
- 39. 1/2" FIBER BOARD ON 1/2" FIBER BOARD
- 40. 1/2" FIBER BOARD ON 1/2" FIBER BOARD
- 41. 1/2" FIBER BOARD ON 1/2" FIBER BOARD
- 42. 1/2" FIBER BOARD ON 1/2" FIBER BOARD
- 43. 1/2" FIBER BOARD ON 1/2" FIBER BOARD
- 44. 1/2" FIBER BOARD ON 1/2" FIBER BOARD
- 45. 1/2" FIBER BOARD ON 1/2" FIBER BOARD
- 46. 1/2" FIBER BOARD ON 1/2" FIBER BOARD
- 47. 1/2" FIBER BOARD ON 1/2" FIBER BOARD
- 48. 1/2" FIBER BOARD ON 1/2" FIBER BOARD
- 49. 1/2" FIBER BOARD ON 1/2" FIBER BOARD
- 50. 1/2" FIBER BOARD ON 1/2" FIBER BOARD
- 51. 1/2" FIBER BOARD ON 1/2" FIBER BOARD
- 52. 1/2" FIBER BOARD ON 1/2" FIBER BOARD
- 53. 1/2" FIBER BOARD ON 1/2" FIBER BOARD
- 54. 1/2" FIBER BOARD ON 1/2" FIBER BOARD
- 55. 1/2" FIBER BOARD ON 1/2" FIBER BOARD
- 56. 1/2" FIBER BOARD ON 1/2" FIBER BOARD
- 57. 1/2" FIBER BOARD ON 1/2" FIBER BOARD
- 58. 1/2" FIBER BOARD ON 1/2" FIBER BOARD
- 59. 1/2" FIBER BOARD ON 1/2" FIBER BOARD
- 60. 1/2" FIBER BOARD ON 1/2" FIBER BOARD
- 61. 1/2" FIBER BOARD ON 1/2" FIBER BOARD
- 62. 1/2" FIBER BOARD ON 1/2" FIBER BOARD
- 63. 1/2" FIBER BOARD ON 1/2" FIBER BOARD
- 64. 1/2" FIBER BOARD ON 1/2" FIBER BOARD
- 65. 1/2" FIBER BOARD ON 1/2" FIBER BOARD
- 66. 1/2" FIBER BOARD ON 1/2" FIBER BOARD
- 67. 1/2" FIBER BOARD ON 1/2" FIBER BOARD
- 68. 1/2" FIBER BOARD ON 1/2" FIBER BOARD
- 69. 1/2" FIBER BOARD ON 1/2" FIBER BOARD
- 70. 1/2" FIBER BOARD ON 1/2" FIBER BOARD
- 71. 1/2" FIBER BOARD ON 1/2" FIBER BOARD
- 72. 1/2" FIBER BOARD ON 1/2" FIBER BOARD
- 73. 1/2" FIBER BOARD ON 1/2" FIBER BOARD
- 74. 1/2" FIBER BOARD ON 1/2" FIBER BOARD
- 75. 1/2" FIBER BOARD ON 1/2" FIBER BOARD
- 76. 1/2" FIBER BOARD ON 1/2" FIBER BOARD
- 77. 1/2" FIBER BOARD ON 1/2" FIBER BOARD
- 78. 1/2" FIBER BOARD ON 1/2" FIBER BOARD
- 79. 1/2" FIBER BOARD ON 1/2" FIBER BOARD
- 80. 1/2" FIBER BOARD ON 1/2" FIBER BOARD
- 81. 1/2" FIBER BOARD ON 1/2" FIBER BOARD
- 82. 1/2" FIBER BOARD ON 1/2" FIBER BOARD
- 83. 1/2" FIBER BOARD ON 1/2" FIBER BOARD
- 84. 1/2" FIBER BOARD ON 1/2" FIBER BOARD
- 85. 1/2" FIBER BOARD ON 1/2" FIBER BOARD
- 86. 1/2" FIBER BOARD ON 1/2" FIBER BOARD
- 87. 1/2" FIBER BOARD ON 1/2" FIBER BOARD
- 88. 1/2" FIBER BOARD ON 1/2" FIBER BOARD
- 89. 1/2" FIBER BOARD ON 1/2" FIBER BOARD
- 90. 1/2" FIBER BOARD ON 1/2" FIBER BOARD
- 91. 1/2" FIBER BOARD ON 1/2" FIBER BOARD
- 92. 1/2" FIBER BOARD ON 1/2" FIBER BOARD
- 93. 1/2" FIBER BOARD ON 1/2" FIBER BOARD
- 94. 1/2" FIBER BOARD ON 1/2" FIBER BOARD
- 95. 1/2" FIBER BOARD ON 1/2" FIBER BOARD
- 96. 1/2" FIBER BOARD ON 1/2" FIBER BOARD
- 97. 1/2" FIBER BOARD ON 1/2" FIBER BOARD
- 98. 1/2" FIBER BOARD ON 1/2" FIBER BOARD
- 99. 1/2" FIBER BOARD ON 1/2" FIBER BOARD
- 100. 1/2" FIBER BOARD ON 1/2" FIBER BOARD

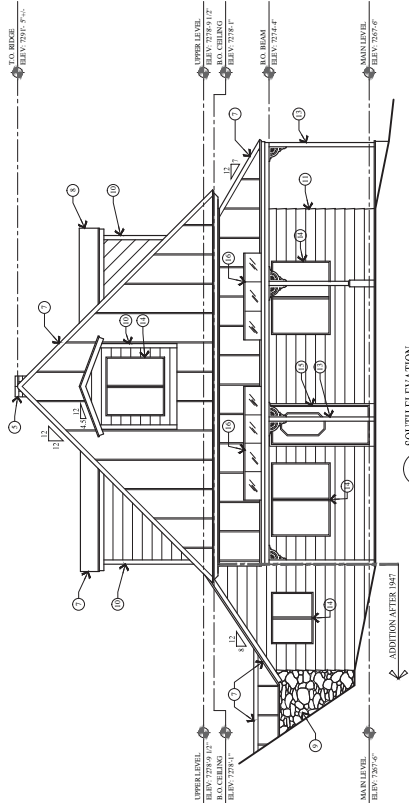

1. SOUTH ELEVATION  
 SCALE: 1/4" = 1'-0"

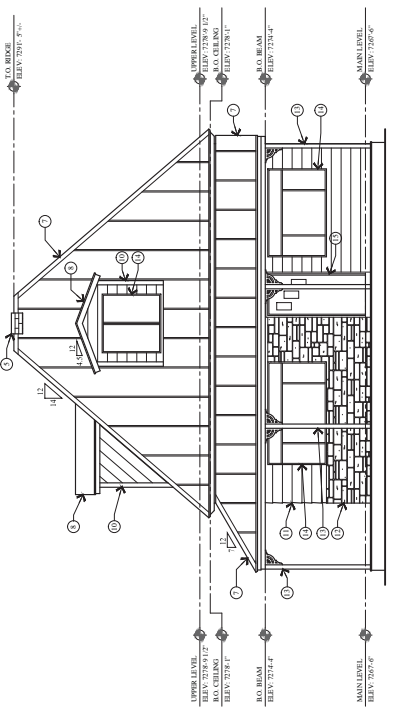

2. EAST ELEVATION  
 SCALE: 1/4" = 1'-0"

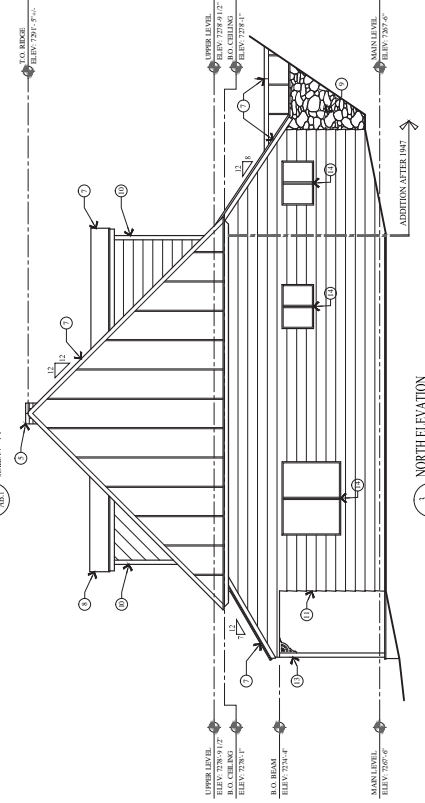

3. NORTH ELEVATION  
 SCALE: 1/4" = 1'-0"

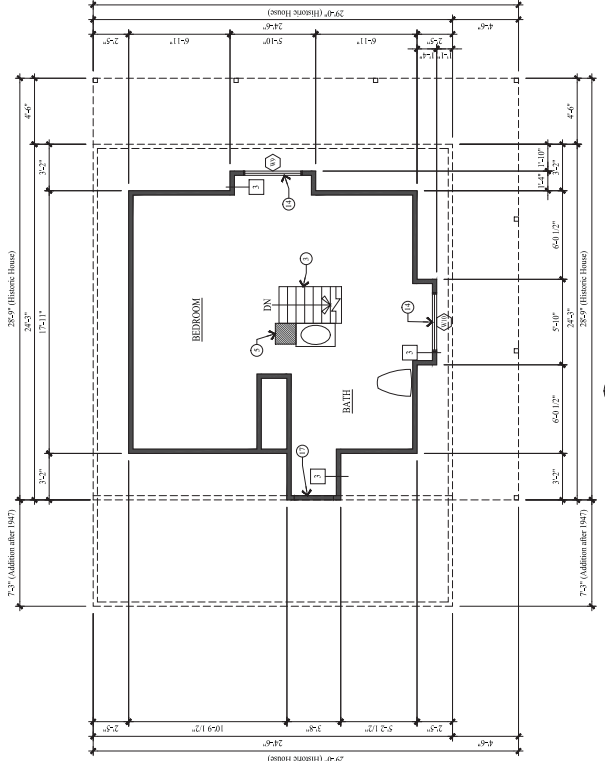

UPPER LEVEL PLAN  
 SCALE: 1/8" = 1'-0"

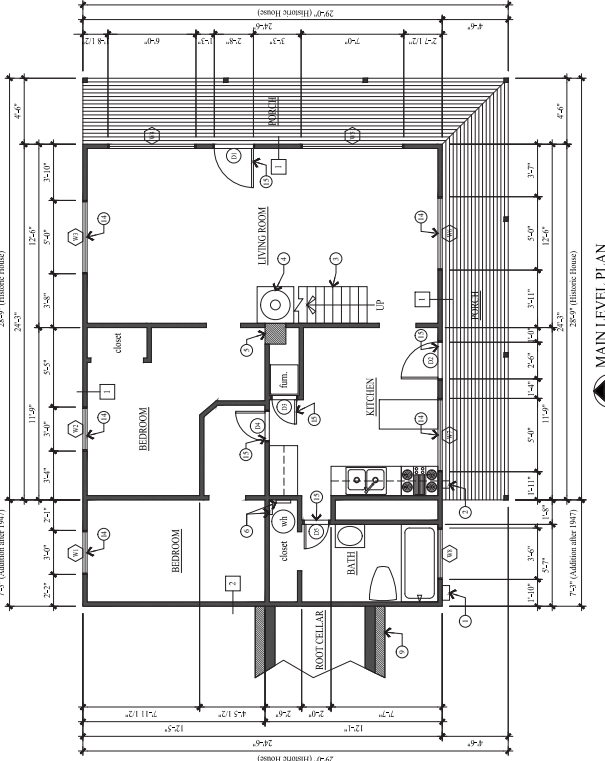

MAIN LEVEL PLAN  
 SCALE: 1/8" = 1'-0"

THE GRAPHIC MATERIAL AND DESIGN ON THIS SHEET ARE THE PROPERTY OF JONATHAN DEGRAJ ARCHITECTURE, INC. ANY REPRODUCTION OR TRANSMISSION OF THIS SHEET WITHOUT THE WRITTEN CONSENT OF JONATHAN DEGRAJ ARCHITECTURE, INC. IS PROHIBITED TO THE FULLEST EXTENT OF THE LAW.

**GENERAL NOTES**

- SIZE EXAMINER:**
1. ALL SURFACE WATER SHALL DRAIN AWAY FROM THE PROPERTY TO THE STREET OR AN APPROVED DRAINAGE COURSE BUT NOT ONTO THE PROPERTY.
  2. ALL DRAINAGE SHALL BE INSTALLED OVER A FILTER FABRIC OR GEOTEXTILE. THE DRAINAGE SHALL FALL A MINIMUM OF 1/4" PER FOOT TO THE STREET OR DRAINAGE FIRST TO FEET - IRC 84013.
- STABILIZATION/CONSTRUCTION ENTRANCE:**
1. FOR A MINIMUM OF 50' FROM ROADWAY, A FILTER FABRIC SHALL BE INSTALLED OVER A 4" FREE DRAIN PER WRAPPED IN 18" OF FREE DRAINING GRAVEL.
  2. ALL CONSTRUCTION SHALL BE INSTALLED OVER THIS AGGREGATE. DAILY INSPECTION FOR SETTLEMENT SHALL BE PERFORMED. ALL SETTLEMENT SHALL BE REPAIRED AND REMEASURED AT ONCE.
- GRADING NOTES:**
1. GRADING TO COMPLY WITH IRC CHAPTER 4.
  2. MAXIMUM ADVERSE SLOPES AT 2:1.
  3. MINIMUM SLOPE FOR DRAINAGE = 2%.
  4. ALL GRADING SHALL BE PERFORMED WITHIN THE EXISTING PROPERTY BOUNDARIES.
  5. EXISTING RETAINING WALLS SHALL BE MAINTAINED UNLESS OTHERWISE NOTED.
  6. EXCAVATION NOT TO EXCEED 2:1 SLOPE WITHOUT A SOILS REPORT.
- UTILITY NOTES:**
1. ALL UTILITY LINES TO BE UNDERGROUND.
  2. ABOVE GRADE UTILITY BOX TO BE IN ACCORDANCE WITH LOCAL CODES.
- SNOW REMOVAL:**
- SNOW PLOWED FROM DRIVE SHALL NOT BE PUSHED ONTO THE STREET.

**LEGEND**

- WATER SERVICE LID
- UTILITY POLE
- SEWER MANHOLE
- ELECTRIC METER BOX
- GAS METER
- STORAGE DRAIN MANHOLE
- ROAD SIGNAGE
- LOD FENCE
- SURFACE DRAINAGE FLOW
- EXISTING CONTOUR LINE
- NEW CONTOUR LINE
- WATER LATERAL LINE
- SEWER LATERAL LINE
- GAS LINE
- OVERHEAD UTILITY LINE
- FOUNDATION DRAIN LINE
- ORIGINAL CONTOUR LINE
- PROBATION TO UNDISTURBED GRADE

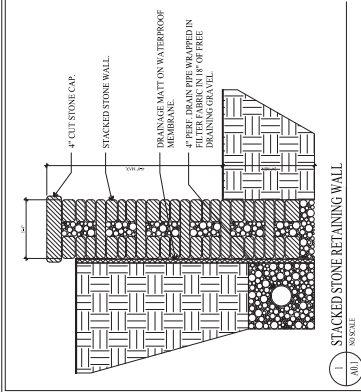

STACKED STONE RETAINING WALL

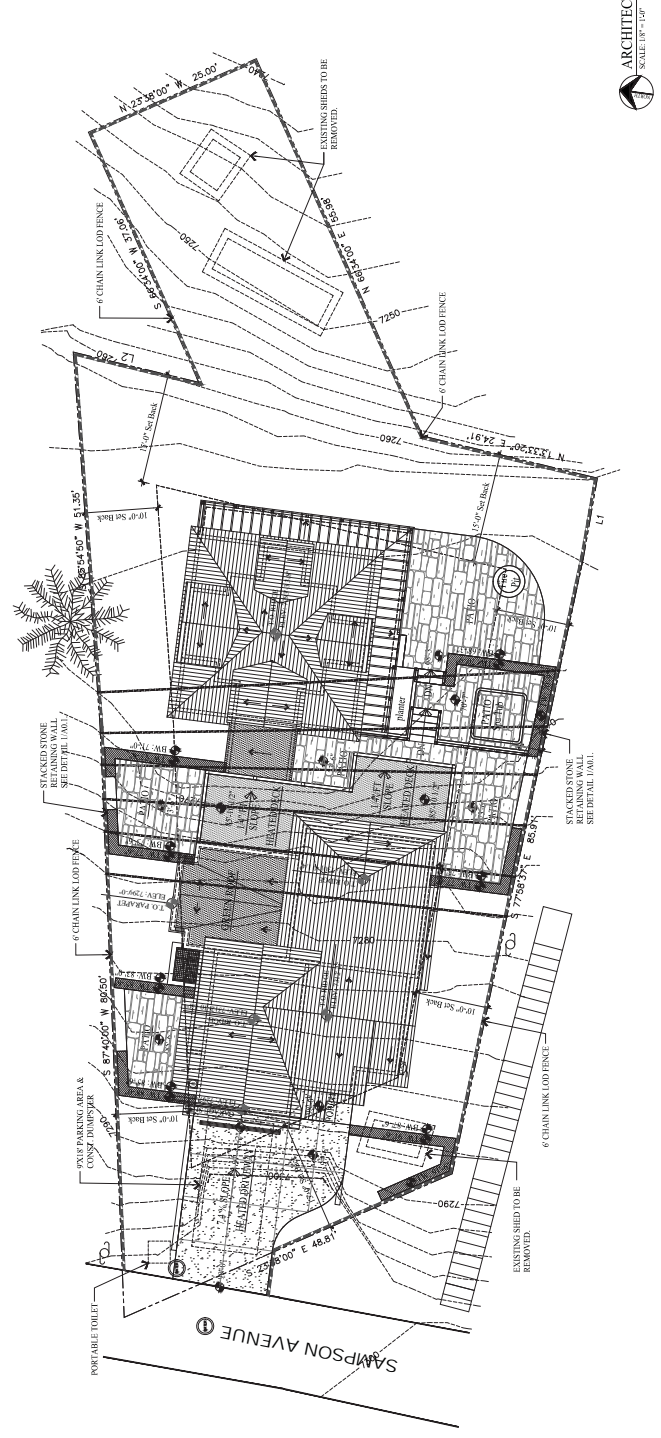



SYMBOL KEY	QUANTITY	COMMON NAME	SCIENTIFIC NAME	SIZE	SPACING	COMMENTS
(Symbol)	1	Colorado Blue Spruce	<i>Picea pungens</i>	6-8"	15'	
(Symbol)	5	Rocky Mtn. Maple	<i>Acer glaberrimus</i>	12" DBH	5-6'	
(Symbol)	3	Aspen	<i>Populus tremuloides</i>	12" DBH	5-6'	
(Symbol)	11	Red Pine	<i>Pinus resinosa</i>	5 Gal		Spacing as noted on plan
(Symbol)	8	Mountain Sage	<i>Artemisia tridentata</i>	5 Gal		Spacing as noted on plan
(Symbol)	10	Blackberry	<i>Rubus</i>	1 Gal	12"-18"	Distribute Equally
(Symbol)	10	Cornus	<i>Cornus</i>	1 Gal	12"-18"	Distribute Equally
(Symbol)	10	Trailing Daisy	<i>Erigeron phillyrifolius</i>	1 Gal	12"-18"	Distribute Equally
(Symbol)	10	Blanket Flower	<i>Gallium aparine</i>	1 Gal	12"-18"	Distribute Equally
<b>GREEN GRASS MIX (DIVERSIFIED)</b>						
(Symbol)	30	Mountain Larch	<i>Larix laricina</i>	12" Pot	12"-24"	Distribute Equally
(Symbol)	30	European Larch	<i>Larix laricina</i>	12" Pot	12"-24"	Distribute Equally
(Symbol)	315 SF	Wood Chips		Small	1" THICK LAYER	
(Symbol)	311 SF	Native Grass Seed Mix		1 Bu 1500 lb hydrated		See seed mix below

**NATIVE GRASS SEED MIX**  
The seed mix shall be applied in areas specified for native grasses. This mixture shall be applied at a sufficient rate to achieve germination of 80% of the seed mix. The seed mix shall be applied at a rate of 10 lbs per 1000 sq ft. The seed mix shall be applied to a depth of 1/4" and covered with a 1/4" layer of 80 mesh, or on the following percentages:  
• 50% Native Grasses, 20% Deciduous Whorlgrasses, 15% Perennial Ryegrass, 15% Monarda  
• 50% Native Grasses, 10% Alopecurus, 10% Bromus, 10% Festuca, 10% Pennisetum, 10% Panicum, 10% Sorghum, 10% Setaria  
• In addition, add 10 lbs. seed mix of 1 lbm. lewisii and Penstemon. Emulate with native grass seed mixture.

**PLANTING NOTES**  
1. CONTRACTOR TO VERIFY LOCATION OF ALL UTILITIES PRIOR TO INSTALLATION OF EXCAVATION OR PLANTING OPERATIONS. ANY DAMAGE TO EXISTING UTILITIES SHALL BE REPAIRED AT CONTRACTOR'S EXPENSE.  
2. ALL PLANT MATERIALS SHALL CONFORM TO CURRENT AMERICAN ASSOCIATION OF NURSERYMEN STANDARD SPECIFICATIONS.  
3. ALL PLANT MATERIALS SHALL BE INSTALLED AS PER DRAWINGS, BE HEALTHY AND SPECIFICATIONS.  
4. CONTRACTOR SHALL VERIFY ALL QUANTITIES. IN CASE OF A DISCREPANCY, THE CONTRACTOR SHALL COORDINATE ALL PLANTING WITH IRRIGATION.  
5. CONTRACTOR SHALL COORDINATE ALL PLANTING WITH IRRIGATION.  
6. IN THE EVENT OF A DISCREPANCY NOTIFY THE ARCHITECT OR OWNER IMMEDIATELY.  
7. ALL PLANTING SHALL BE ALLOWED WITHOUT WRITTEN PERMISSION OF THE ARCHITECT OR OWNER.  
8. ALL SHRUBS SHALL HAVE 6" OF PROTECTIVE BARK MULCH INSTALLED.  
9. SHRUBS SHALL BE PLANTED AT THE SPECIFIED LOCATIONS.  
10. SHRUBS SHALL BE PLANTED AT THE SPECIFIED LOCATIONS.  
11. ALL PLANTS AND ALL PLANT STOCKS SHALL BE SET PLUMB.  
12. ALL PLANTS AND ALL PLANT STOCKS SHALL BE SET PLUMB.  
13. MOISTURE RETENTION MULCH SHALL BE USED.

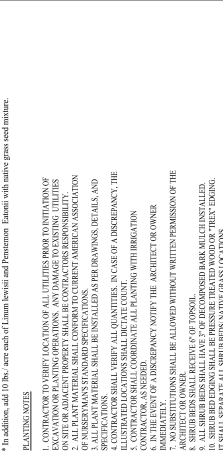



- GENERAL NOTES**
1. ALL DIMENSIONS ARE APPROXIMATE AND ARE TO BE FIELD VERIFIED PRIOR TO ANY CONSTRUCTION.
  2. EXTERIOR WALLS TO BE 24" FRAMING W/ 8" INSULATION. INTERIOR WALLS TO BE 12" FRAMING W/ 4" INSULATION. ALL WALLS TO BE FINISHED WITH GYP. BOARD.
  3. FLOORING SHALL BE ON THE FRAMING. ALL FLOORING SHALL BE ON THE FRAMING. ALL FLOORING SHALL BE ON THE FRAMING.
  4. AIR LEAKAGE: THE BUILDING THERMAL ENVELOPE SHALL BE CONSTRUCTED TO LIMIT AIR INFILTRATION. SEE DETAIL 1.1.1.
  5. TWO INSURANCE POLICIES ARE REQUIRED: HOMEOWNERS POLICY AND LIABILITY POLICY.
- KEY NOTES**
1. ARCHITECTURAL GRADE COMPOSITION TO BE MAINTAINED. ANY CHANGES SHALL BE APPROVED BY THE HISTORIC DISTRICT.
  2. EXTERIOR WALLS TO BE 24" FRAMING W/ 8" INSULATION. INTERIOR WALLS TO BE 12" FRAMING W/ 4" INSULATION. ALL WALLS TO BE FINISHED WITH GYP. BOARD.
  3. NON-REFLECTIVE STANDING SEAM METAL ROOF. METAL ROOF TO BE CLASS APPROVED.
  4. EXTERIOR SHEATHING ON ROOF JOIST - 1/2" OSB. EXTERIOR FINISH TO BE CLASS APPROVED.
  5. STRUCTURAL FLOOR SIZE AND SPACING TO BE MAINTAINED. SEE SHEET AS 1.1 FOR DETAILS.
  6. TUBS AND SHOWER WITH TILED WALLS. FINISH TO BE CLASS APPROVED. GLASS WALL TO BE CLASS APPROVED.
  7. 4" TYPE 'XC' IN GARAGE CEILING AND WALL SPACING TO BE MAINTAINED. SEE DETAIL 1.1.1.
  8. 4" TYPE 'XC' IN GARAGE CEILING AND WALL SPACING TO BE MAINTAINED. SEE DETAIL 1.1.1.
  9. HEATED DECK. WATERPROOFING MEMBRANE ON 1" X 2" WOOD JOIST. SEE DETAIL 1.1.1.
  10. PROPERTY LINE. SEE DETAIL 1.1.1.
  11. LINE OF WALL BEAM ABOVE.
  12. 2x6 TRUSS ON 24" SPACING. SEE DETAIL 1.1.1.
  13. APPLIANCE APPROVED FOR SLEEPING AREAS.
  14. 2x6 TRUSS ON 24" SPACING. SEE DETAIL 1.1.1.
  15. 2x6 TRUSS ON 24" SPACING. SEE DETAIL 1.1.1.
  16. 2x6 TRUSS ON 24" SPACING. SEE DETAIL 1.1.1.
  17. 2x6 TRUSS ON 24" SPACING. SEE DETAIL 1.1.1.
  18. 2x6 TRUSS ON 24" SPACING. SEE DETAIL 1.1.1.
  19. 2x6 TRUSS ON 24" SPACING. SEE DETAIL 1.1.1.
  20. 2x6 TRUSS ON 24" SPACING. SEE DETAIL 1.1.1.
  21. 2x6 TRUSS ON 24" SPACING. SEE DETAIL 1.1.1.
  22. 2x6 TRUSS ON 24" SPACING. SEE DETAIL 1.1.1.
  23. 2x6 TRUSS ON 24" SPACING. SEE DETAIL 1.1.1.
  24. 2x6 TRUSS ON 24" SPACING. SEE DETAIL 1.1.1.
  25. 2x6 TRUSS ON 24" SPACING. SEE DETAIL 1.1.1.
  26. 2x6 TRUSS ON 24" SPACING. SEE DETAIL 1.1.1.
  27. 2x6 TRUSS ON 24" SPACING. SEE DETAIL 1.1.1.
  28. 2x6 TRUSS ON 24" SPACING. SEE DETAIL 1.1.1.
  29. 2x6 TRUSS ON 24" SPACING. SEE DETAIL 1.1.1.
  30. 2x6 TRUSS ON 24" SPACING. SEE DETAIL 1.1.1.
  31. 2x6 TRUSS ON 24" SPACING. SEE DETAIL 1.1.1.
  32. 2x6 TRUSS ON 24" SPACING. SEE DETAIL 1.1.1.
  33. 2x6 TRUSS ON 24" SPACING. SEE DETAIL 1.1.1.
  34. 2x6 TRUSS ON 24" SPACING. SEE DETAIL 1.1.1.
  35. 2x6 TRUSS ON 24" SPACING. SEE DETAIL 1.1.1.
  36. 2x6 TRUSS ON 24" SPACING. SEE DETAIL 1.1.1.
  37. 2x6 TRUSS ON 24" SPACING. SEE DETAIL 1.1.1.
  38. 2x6 TRUSS ON 24" SPACING. SEE DETAIL 1.1.1.
  39. 2x6 TRUSS ON 24" SPACING. SEE DETAIL 1.1.1.
  40. 2x6 TRUSS ON 24" SPACING. SEE DETAIL 1.1.1.
  41. 2x6 TRUSS ON 24" SPACING. SEE DETAIL 1.1.1.
  42. 2x6 TRUSS ON 24" SPACING. SEE DETAIL 1.1.1.
  43. 2x6 TRUSS ON 24" SPACING. SEE DETAIL 1.1.1.
  44. 2x6 TRUSS ON 24" SPACING. SEE DETAIL 1.1.1.
  45. 2x6 TRUSS ON 24" SPACING. SEE DETAIL 1.1.1.
  46. 2x6 TRUSS ON 24" SPACING. SEE DETAIL 1.1.1.
  47. 2x6 TRUSS ON 24" SPACING. SEE DETAIL 1.1.1.
  48. 2x6 TRUSS ON 24" SPACING. SEE DETAIL 1.1.1.
  49. 2x6 TRUSS ON 24" SPACING. SEE DETAIL 1.1.1.
  50. 2x6 TRUSS ON 24" SPACING. SEE DETAIL 1.1.1.
  51. 2x6 TRUSS ON 24" SPACING. SEE DETAIL 1.1.1.
  52. 2x6 TRUSS ON 24" SPACING. SEE DETAIL 1.1.1.
  53. 2x6 TRUSS ON 24" SPACING. SEE DETAIL 1.1.1.
  54. 2x6 TRUSS ON 24" SPACING. SEE DETAIL 1.1.1.
  55. 2x6 TRUSS ON 24" SPACING. SEE DETAIL 1.1.1.
  56. 2x6 TRUSS ON 24" SPACING. SEE DETAIL 1.1.1.
  57. 2x6 TRUSS ON 24" SPACING. SEE DETAIL 1.1.1.
  58. 2x6 TRUSS ON 24" SPACING. SEE DETAIL 1.1.1.
  59. 2x6 TRUSS ON 24" SPACING. SEE DETAIL 1.1.1.
  60. 2x6 TRUSS ON 24" SPACING. SEE DETAIL 1.1.1.
  61. 2x6 TRUSS ON 24" SPACING. SEE DETAIL 1.1.1.
  62. 2x6 TRUSS ON 24" SPACING. SEE DETAIL 1.1.1.
  63. 2x6 TRUSS ON 24" SPACING. SEE DETAIL 1.1.1.
  64. 2x6 TRUSS ON 24" SPACING. SEE DETAIL 1.1.1.
  65. 2x6 TRUSS ON 24" SPACING. SEE DETAIL 1.1.1.
  66. 2x6 TRUSS ON 24" SPACING. SEE DETAIL 1.1.1.
  67. 2x6 TRUSS ON 24" SPACING. SEE DETAIL 1.1.1.
  68. 2x6 TRUSS ON 24" SPACING. SEE DETAIL 1.1.1.
  69. 2x6 TRUSS ON 24" SPACING. SEE DETAIL 1.1.1.
  70. 2x6 TRUSS ON 24" SPACING. SEE DETAIL 1.1.1.
  71. 2x6 TRUSS ON 24" SPACING. SEE DETAIL 1.1.1.
  72. 2x6 TRUSS ON 24" SPACING. SEE DETAIL 1.1.1.
  73. 2x6 TRUSS ON 24" SPACING. SEE DETAIL 1.1.1.
  74. 2x6 TRUSS ON 24" SPACING. SEE DETAIL 1.1.1.
  75. 2x6 TRUSS ON 24" SPACING. SEE DETAIL 1.1.1.
  76. 2x6 TRUSS ON 24" SPACING. SEE DETAIL 1.1.1.
  77. 2x6 TRUSS ON 24" SPACING. SEE DETAIL 1.1.1.
  78. 2x6 TRUSS ON 24" SPACING. SEE DETAIL 1.1.1.
  79. 2x6 TRUSS ON 24" SPACING. SEE DETAIL 1.1.1.
  80. 2x6 TRUSS ON 24" SPACING. SEE DETAIL 1.1.1.
  81. 2x6 TRUSS ON 24" SPACING. SEE DETAIL 1.1.1.
  82. 2x6 TRUSS ON 24" SPACING. SEE DETAIL 1.1.1.
  83. 2x6 TRUSS ON 24" SPACING. SEE DETAIL 1.1.1.
  84. 2x6 TRUSS ON 24" SPACING. SEE DETAIL 1.1.1.
  85. 2x6 TRUSS ON 24" SPACING. SEE DETAIL 1.1.1.
  86. 2x6 TRUSS ON 24" SPACING. SEE DETAIL 1.1.1.
  87. 2x6 TRUSS ON 24" SPACING. SEE DETAIL 1.1.1.
  88. 2x6 TRUSS ON 24" SPACING. SEE DETAIL 1.1.1.
  89. 2x6 TRUSS ON 24" SPACING. SEE DETAIL 1.1.1.
  90. 2x6 TRUSS ON 24" SPACING. SEE DETAIL 1.1.1.
  91. 2x6 TRUSS ON 24" SPACING. SEE DETAIL 1.1.1.
  92. 2x6 TRUSS ON 24" SPACING. SEE DETAIL 1.1.1.
  93. 2x6 TRUSS ON 24" SPACING. SEE DETAIL 1.1.1.
  94. 2x6 TRUSS ON 24" SPACING. SEE DETAIL 1.1.1.
  95. 2x6 TRUSS ON 24" SPACING. SEE DETAIL 1.1.1.
  96. 2x6 TRUSS ON 24" SPACING. SEE DETAIL 1.1.1.
  97. 2x6 TRUSS ON 24" SPACING. SEE DETAIL 1.1.1.
  98. 2x6 TRUSS ON 24" SPACING. SEE DETAIL 1.1.1.
  99. 2x6 TRUSS ON 24" SPACING. SEE DETAIL 1.1.1.
  100. 2x6 TRUSS ON 24" SPACING. SEE DETAIL 1.1.1.

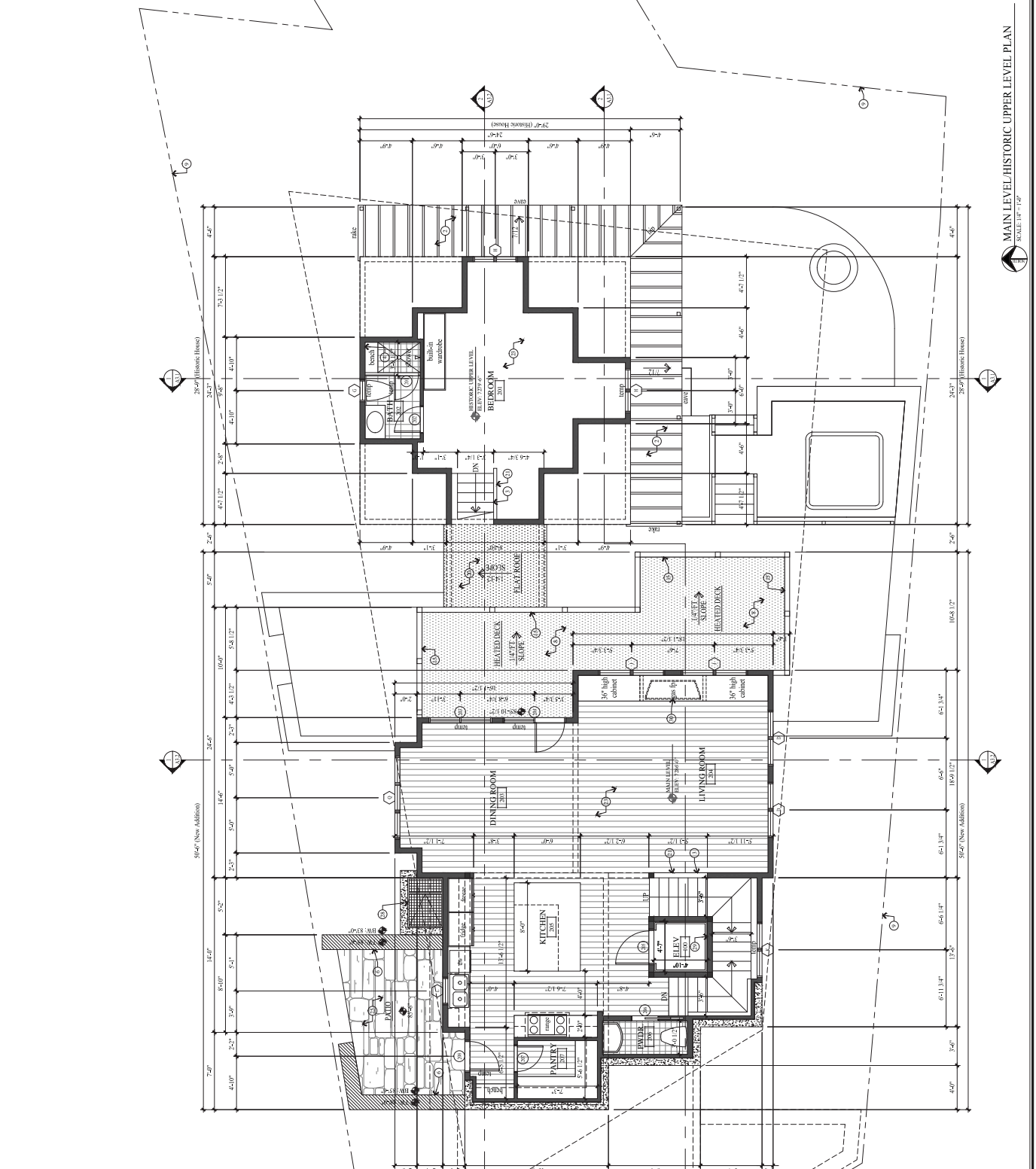

**MAIN LEVEL/HISTORIC UPPER LEVEL PLAN**  
 SCALE: 1/8" = 1'-0"

THE DRAWING MATERIAL AND DESIGN ON THIS SHEET ARE THE PROPERTY OF JONATHAN DEGRAY ARCHITECT. REPRODUCTION OR USE OF THIS MATERIAL AND DESIGN CONTAINING HEREIN IS PROHIBITED WITHOUT THE WRITTEN CONSENT OF JONATHAN DEGRAY ARCHITECT. THE CLIENT AND DESIGN PROFESSIONAL SHALL BE PROTECTED BY THE FULL EXTENT OF THE LAW.







KEY NOTES

1. SHIMMERING METAL CLADDING: SINGLE-SIDE PRESIDENTIAL FLUSH PER SHIMMERING METAL CLADDING MANUFACTURER'S RECOMMENDATIONS. SEE STRUCTURAL FOR SIZE AND SPACING.
2. NON-REFLECTIVE STANDING SEAM METAL CLADDING: SINGLE-SIDE PRESIDENTIAL FLUSH PER SHIMMERING METAL CLADDING MANUFACTURER'S RECOMMENDATIONS. SEE STRUCTURAL FOR SIZE AND SPACING.
3. HEATED DECK WATERPROOF MEMBRANE ON 1" SLEEPERS ON 14" PT WOOD ON 12" DECK JOIST.
4. ORIGINAL CONTROL LINE PRIOR TO DISTRIBUTION.
5. EXTERIOR RENOVATED WATERPROOF MEMBRANE ON 14" PT WOOD ON 21/2" ROOF SHEATHING. 14" PER FOOT SEE STRUCTURAL FOR DETAILS.
6. 14" TRG SMOOTH W/ CONTIGUOUS SMOOTH VENT.
7. 12" x 12" CONTIGUOUS METAL Drip Edge.
8. 14" x 14" CONTIGUOUS METAL Drip Edge.
9. 12" x 12" CONTIGUOUS METAL Drip Edge.
10. 14" x 14" CONTIGUOUS METAL Drip Edge.
11. 12" x 12" CONTIGUOUS METAL Drip Edge.
12. 14" x 14" CONTIGUOUS METAL Drip Edge.
13. 12" x 12" CONTIGUOUS METAL Drip Edge.
14. 14" x 14" CONTIGUOUS METAL Drip Edge.
15. 12" x 12" CONTIGUOUS METAL Drip Edge.
16. 14" x 14" CONTIGUOUS METAL Drip Edge.
17. 12" x 12" CONTIGUOUS METAL Drip Edge.
18. 14" x 14" CONTIGUOUS METAL Drip Edge.
19. 12" x 12" CONTIGUOUS METAL Drip Edge.
20. 14" x 14" CONTIGUOUS METAL Drip Edge.
21. 12" x 12" CONTIGUOUS METAL Drip Edge.
22. 14" x 14" CONTIGUOUS METAL Drip Edge.
23. 12" x 12" CONTIGUOUS METAL Drip Edge.
24. 14" x 14" CONTIGUOUS METAL Drip Edge.
25. 12" x 12" CONTIGUOUS METAL Drip Edge.
26. 14" x 14" CONTIGUOUS METAL Drip Edge.
27. 12" x 12" CONTIGUOUS METAL Drip Edge.
28. 14" x 14" CONTIGUOUS METAL Drip Edge.
29. 12" x 12" CONTIGUOUS METAL Drip Edge.
30. 14" x 14" CONTIGUOUS METAL Drip Edge.
31. 12" x 12" CONTIGUOUS METAL Drip Edge.
32. 14" x 14" CONTIGUOUS METAL Drip Edge.
33. 12" x 12" CONTIGUOUS METAL Drip Edge.
34. 14" x 14" CONTIGUOUS METAL Drip Edge.
35. 12" x 12" CONTIGUOUS METAL Drip Edge.
36. 14" x 14" CONTIGUOUS METAL Drip Edge.
37. 12" x 12" CONTIGUOUS METAL Drip Edge.
38. 14" x 14" CONTIGUOUS METAL Drip Edge.
39. 12" x 12" CONTIGUOUS METAL Drip Edge.
40. 14" x 14" CONTIGUOUS METAL Drip Edge.
41. 12" x 12" CONTIGUOUS METAL Drip Edge.
42. 14" x 14" CONTIGUOUS METAL Drip Edge.
43. 12" x 12" CONTIGUOUS METAL Drip Edge.
44. 14" x 14" CONTIGUOUS METAL Drip Edge.
45. 12" x 12" CONTIGUOUS METAL Drip Edge.
46. 14" x 14" CONTIGUOUS METAL Drip Edge.
47. 12" x 12" CONTIGUOUS METAL Drip Edge.
48. 14" x 14" CONTIGUOUS METAL Drip Edge.
49. 12" x 12" CONTIGUOUS METAL Drip Edge.
50. 14" x 14" CONTIGUOUS METAL Drip Edge.
51. 12" x 12" CONTIGUOUS METAL Drip Edge.
52. 14" x 14" CONTIGUOUS METAL Drip Edge.
53. 12" x 12" CONTIGUOUS METAL Drip Edge.
54. 14" x 14" CONTIGUOUS METAL Drip Edge.
55. 12" x 12" CONTIGUOUS METAL Drip Edge.
56. 14" x 14" CONTIGUOUS METAL Drip Edge.
57. 12" x 12" CONTIGUOUS METAL Drip Edge.
58. 14" x 14" CONTIGUOUS METAL Drip Edge.
59. 12" x 12" CONTIGUOUS METAL Drip Edge.
60. 14" x 14" CONTIGUOUS METAL Drip Edge.
61. 12" x 12" CONTIGUOUS METAL Drip Edge.
62. 14" x 14" CONTIGUOUS METAL Drip Edge.
63. 12" x 12" CONTIGUOUS METAL Drip Edge.
64. 14" x 14" CONTIGUOUS METAL Drip Edge.
65. 12" x 12" CONTIGUOUS METAL Drip Edge.
66. 14" x 14" CONTIGUOUS METAL Drip Edge.
67. 12" x 12" CONTIGUOUS METAL Drip Edge.
68. 14" x 14" CONTIGUOUS METAL Drip Edge.
69. 12" x 12" CONTIGUOUS METAL Drip Edge.
70. 14" x 14" CONTIGUOUS METAL Drip Edge.
71. 12" x 12" CONTIGUOUS METAL Drip Edge.
72. 14" x 14" CONTIGUOUS METAL Drip Edge.
73. 12" x 12" CONTIGUOUS METAL Drip Edge.
74. 14" x 14" CONTIGUOUS METAL Drip Edge.
75. 12" x 12" CONTIGUOUS METAL Drip Edge.
76. 14" x 14" CONTIGUOUS METAL Drip Edge.
77. 12" x 12" CONTIGUOUS METAL Drip Edge.
78. 14" x 14" CONTIGUOUS METAL Drip Edge.
79. 12" x 12" CONTIGUOUS METAL Drip Edge.
80. 14" x 14" CONTIGUOUS METAL Drip Edge.
81. 12" x 12" CONTIGUOUS METAL Drip Edge.
82. 14" x 14" CONTIGUOUS METAL Drip Edge.
83. 12" x 12" CONTIGUOUS METAL Drip Edge.
84. 14" x 14" CONTIGUOUS METAL Drip Edge.
85. 12" x 12" CONTIGUOUS METAL Drip Edge.
86. 14" x 14" CONTIGUOUS METAL Drip Edge.
87. 12" x 12" CONTIGUOUS METAL Drip Edge.
88. 14" x 14" CONTIGUOUS METAL Drip Edge.
89. 12" x 12" CONTIGUOUS METAL Drip Edge.
90. 14" x 14" CONTIGUOUS METAL Drip Edge.
91. 12" x 12" CONTIGUOUS METAL Drip Edge.
92. 14" x 14" CONTIGUOUS METAL Drip Edge.
93. 12" x 12" CONTIGUOUS METAL Drip Edge.
94. 14" x 14" CONTIGUOUS METAL Drip Edge.
95. 12" x 12" CONTIGUOUS METAL Drip Edge.
96. 14" x 14" CONTIGUOUS METAL Drip Edge.
97. 12" x 12" CONTIGUOUS METAL Drip Edge.
98. 14" x 14" CONTIGUOUS METAL Drip Edge.
99. 12" x 12" CONTIGUOUS METAL Drip Edge.
100. 14" x 14" CONTIGUOUS METAL Drip Edge.

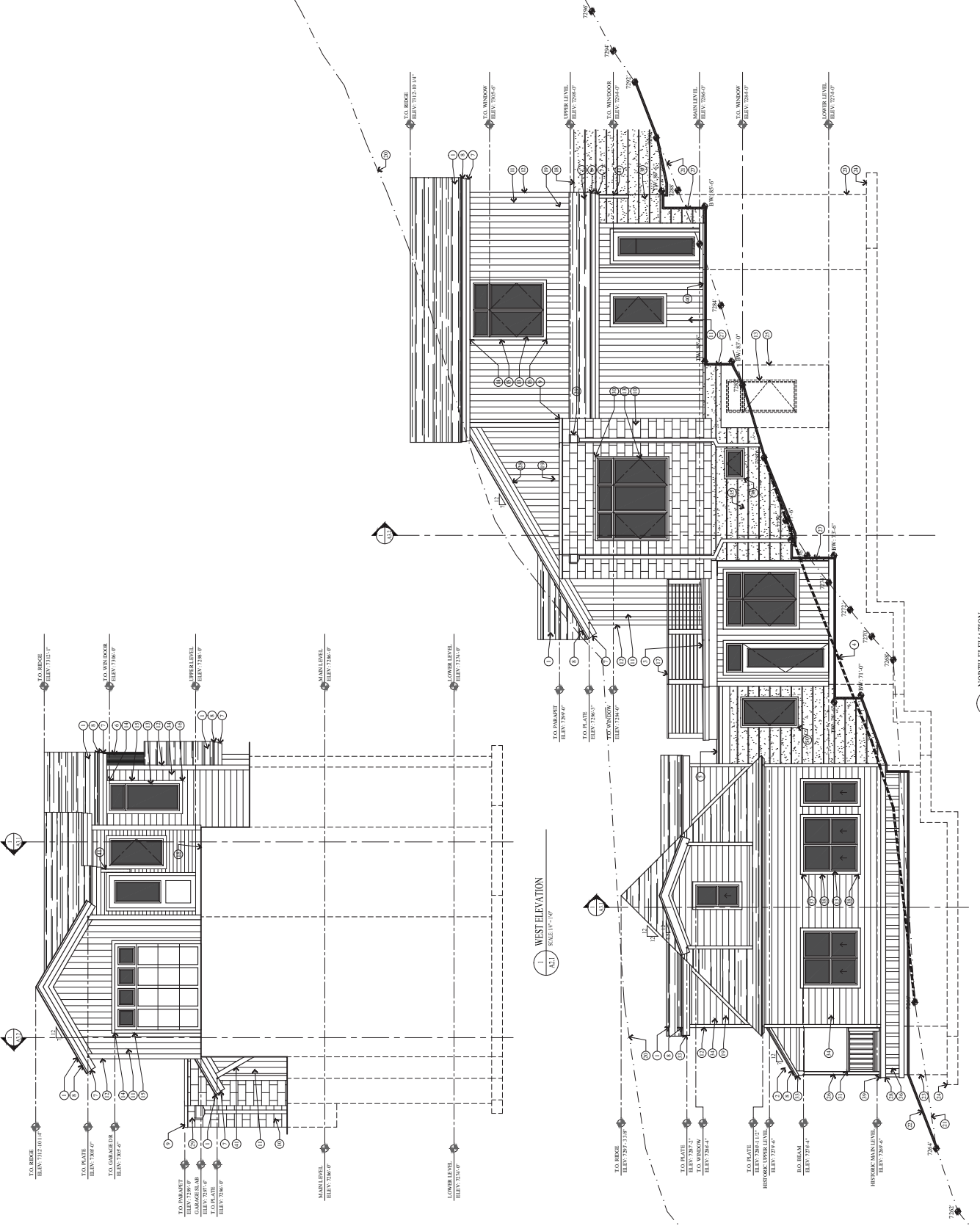

EAST ELEVATIONS

115 SAMPSON AVENUE RESIDENCE  
HISTORIC DISTRICT DESIGN REVIEW SET

Jonathan Degray  
Architect  
P.O. Box 1674, 614 Main Street, Suite 302, Park City, Utah 84060  
P: 435-649-7263 E: jonah.degray@questnet.com

KEY NOTES

- 1) SHINGLE SHALL BE ASBESTOS-FREE, 30-YEAR PRESIDENTIAL CLASS PER 2018 INTERNATIONAL RESIDENTIAL CODE. SHINGLE SHALL BE INSTALLED OVER A 1/2" GYP BOARD OR GYP BOARD WITH A MINIMUM OF 1/2" OF INSULATION. SEE STRUCTURAL FOR SIZE AND SPACING.
- 2) NON-REFLECTIVE STANDING SEAM METAL ROOFING SHALL BE INSTALLED OVER 1/2" GYP BOARD OR GYP BOARD WITH A MINIMUM OF 1/2" OF INSULATION. SEE STRUCTURAL FOR SIZE AND SPACING.
- 3) HEATED DECK WATERPROOF MEMBRANE ON 1" SLEEPERS ON 14" PT WOOD ON 17" DECK POSTS. SEE STRUCTURAL FOR SIZE AND SPACING.
- 4) ORIGINAL CONTIGUOUS LINE PRIOR TO DISTRIBUTION OF THIS SET SHALL BE MAINTAINED FOR DETAILS.
- 5) 1" x 1" x 1/2" CONTIGUOUS METAL Drip Edge.
- 6) 1/4" x 1/4" x 1/2" CONTIGUOUS METAL Drip Edge.
- 7) 1" x 1" x 1/2" CONTIGUOUS METAL Drip Edge.
- 8) 1/4" x 1/4" x 1/2" CONTIGUOUS METAL Drip Edge.
- 9) 1/4" x 1/4" x 1/2" CONTIGUOUS METAL Drip Edge.
- 10) 1/4" x 1/4" x 1/2" CONTIGUOUS METAL Drip Edge.
- 11) 1/4" x 1/4" x 1/2" CONTIGUOUS METAL Drip Edge.
- 12) 1/4" x 1/4" x 1/2" CONTIGUOUS METAL Drip Edge.
- 13) 1/4" x 1/4" x 1/2" CONTIGUOUS METAL Drip Edge.
- 14) 1/4" x 1/4" x 1/2" CONTIGUOUS METAL Drip Edge.
- 15) 1/4" x 1/4" x 1/2" CONTIGUOUS METAL Drip Edge.
- 16) 1/4" x 1/4" x 1/2" CONTIGUOUS METAL Drip Edge.
- 17) 1/4" x 1/4" x 1/2" CONTIGUOUS METAL Drip Edge.
- 18) 1/4" x 1/4" x 1/2" CONTIGUOUS METAL Drip Edge.
- 19) 1/4" x 1/4" x 1/2" CONTIGUOUS METAL Drip Edge.
- 20) 1/4" x 1/4" x 1/2" CONTIGUOUS METAL Drip Edge.
- 21) 1/4" x 1/4" x 1/2" CONTIGUOUS METAL Drip Edge.
- 22) 1/4" x 1/4" x 1/2" CONTIGUOUS METAL Drip Edge.
- 23) 1/4" x 1/4" x 1/2" CONTIGUOUS METAL Drip Edge.
- 24) 1/4" x 1/4" x 1/2" CONTIGUOUS METAL Drip Edge.
- 25) 1/4" x 1/4" x 1/2" CONTIGUOUS METAL Drip Edge.
- 26) 1/4" x 1/4" x 1/2" CONTIGUOUS METAL Drip Edge.
- 27) 1/4" x 1/4" x 1/2" CONTIGUOUS METAL Drip Edge.
- 28) 1/4" x 1/4" x 1/2" CONTIGUOUS METAL Drip Edge.
- 29) 1/4" x 1/4" x 1/2" CONTIGUOUS METAL Drip Edge.
- 30) 1/4" x 1/4" x 1/2" CONTIGUOUS METAL Drip Edge.
- 31) 1/4" x 1/4" x 1/2" CONTIGUOUS METAL Drip Edge.
- 32) 1/4" x 1/4" x 1/2" CONTIGUOUS METAL Drip Edge.
- 33) 1/4" x 1/4" x 1/2" CONTIGUOUS METAL Drip Edge.
- 34) 1/4" x 1/4" x 1/2" CONTIGUOUS METAL Drip Edge.
- 35) 1/4" x 1/4" x 1/2" CONTIGUOUS METAL Drip Edge.
- 36) 1/4" x 1/4" x 1/2" CONTIGUOUS METAL Drip Edge.
- 37) 1/4" x 1/4" x 1/2" CONTIGUOUS METAL Drip Edge.
- 38) 1/4" x 1/4" x 1/2" CONTIGUOUS METAL Drip Edge.
- 39) 1/4" x 1/4" x 1/2" CONTIGUOUS METAL Drip Edge.
- 40) 1/4" x 1/4" x 1/2" CONTIGUOUS METAL Drip Edge.
- 41) 1/4" x 1/4" x 1/2" CONTIGUOUS METAL Drip Edge.
- 42) 1/4" x 1/4" x 1/2" CONTIGUOUS METAL Drip Edge.
- 43) 1/4" x 1/4" x 1/2" CONTIGUOUS METAL Drip Edge.
- 44) 1/4" x 1/4" x 1/2" CONTIGUOUS METAL Drip Edge.
- 45) 1/4" x 1/4" x 1/2" CONTIGUOUS METAL Drip Edge.
- 46) 1/4" x 1/4" x 1/2" CONTIGUOUS METAL Drip Edge.
- 47) 1/4" x 1/4" x 1/2" CONTIGUOUS METAL Drip Edge.
- 48) 1/4" x 1/4" x 1/2" CONTIGUOUS METAL Drip Edge.
- 49) 1/4" x 1/4" x 1/2" CONTIGUOUS METAL Drip Edge.
- 50) 1/4" x 1/4" x 1/2" CONTIGUOUS METAL Drip Edge.
- 51) 1/4" x 1/4" x 1/2" CONTIGUOUS METAL Drip Edge.
- 52) 1/4" x 1/4" x 1/2" CONTIGUOUS METAL Drip Edge.
- 53) 1/4" x 1/4" x 1/2" CONTIGUOUS METAL Drip Edge.
- 54) 1/4" x 1/4" x 1/2" CONTIGUOUS METAL Drip Edge.
- 55) 1/4" x 1/4" x 1/2" CONTIGUOUS METAL Drip Edge.
- 56) 1/4" x 1/4" x 1/2" CONTIGUOUS METAL Drip Edge.
- 57) 1/4" x 1/4" x 1/2" CONTIGUOUS METAL Drip Edge.
- 58) 1/4" x 1/4" x 1/2" CONTIGUOUS METAL Drip Edge.
- 59) 1/4" x 1/4" x 1/2" CONTIGUOUS METAL Drip Edge.
- 60) 1/4" x 1/4" x 1/2" CONTIGUOUS METAL Drip Edge.
- 61) 1/4" x 1/4" x 1/2" CONTIGUOUS METAL Drip Edge.
- 62) 1/4" x 1/4" x 1/2" CONTIGUOUS METAL Drip Edge.
- 63) 1/4" x 1/4" x 1/2" CONTIGUOUS METAL Drip Edge.
- 64) 1/4" x 1/4" x 1/2" CONTIGUOUS METAL Drip Edge.
- 65) 1/4" x 1/4" x 1/2" CONTIGUOUS METAL Drip Edge.
- 66) 1/4" x 1/4" x 1/2" CONTIGUOUS METAL Drip Edge.
- 67) 1/4" x 1/4" x 1/2" CONTIGUOUS METAL Drip Edge.
- 68) 1/4" x 1/4" x 1/2" CONTIGUOUS METAL Drip Edge.
- 69) 1/4" x 1/4" x 1/2" CONTIGUOUS METAL Drip Edge.
- 70) 1/4" x 1/4" x 1/2" CONTIGUOUS METAL Drip Edge.
- 71) 1/4" x 1/4" x 1/2" CONTIGUOUS METAL Drip Edge.
- 72) 1/4" x 1/4" x 1/2" CONTIGUOUS METAL Drip Edge.
- 73) 1/4" x 1/4" x 1/2" CONTIGUOUS METAL Drip Edge.
- 74) 1/4" x 1/4" x 1/2" CONTIGUOUS METAL Drip Edge.
- 75) 1/4" x 1/4" x 1/2" CONTIGUOUS METAL Drip Edge.
- 76) 1/4" x 1/4" x 1/2" CONTIGUOUS METAL Drip Edge.
- 77) 1/4" x 1/4" x 1/2" CONTIGUOUS METAL Drip Edge.
- 78) 1/4" x 1/4" x 1/2" CONTIGUOUS METAL Drip Edge.
- 79) 1/4" x 1/4" x 1/2" CONTIGUOUS METAL Drip Edge.
- 80) 1/4" x 1/4" x 1/2" CONTIGUOUS METAL Drip Edge.
- 81) 1/4" x 1/4" x 1/2" CONTIGUOUS METAL Drip Edge.
- 82) 1/4" x 1/4" x 1/2" CONTIGUOUS METAL Drip Edge.
- 83) 1/4" x 1/4" x 1/2" CONTIGUOUS METAL Drip Edge.
- 84) 1/4" x 1/4" x 1/2" CONTIGUOUS METAL Drip Edge.
- 85) 1/4" x 1/4" x 1/2" CONTIGUOUS METAL Drip Edge.
- 86) 1/4" x 1/4" x 1/2" CONTIGUOUS METAL Drip Edge.
- 87) 1/4" x 1/4" x 1/2" CONTIGUOUS METAL Drip Edge.
- 88) 1/4" x 1/4" x 1/2" CONTIGUOUS METAL Drip Edge.
- 89) 1/4" x 1/4" x 1/2" CONTIGUOUS METAL Drip Edge.
- 90) 1/4" x 1/4" x 1/2" CONTIGUOUS METAL Drip Edge.
- 91) 1/4" x 1/4" x 1/2" CONTIGUOUS METAL Drip Edge.
- 92) 1/4" x 1/4" x 1/2" CONTIGUOUS METAL Drip Edge.
- 93) 1/4" x 1/4" x 1/2" CONTIGUOUS METAL Drip Edge.
- 94) 1/4" x 1/4" x 1/2" CONTIGUOUS METAL Drip Edge.
- 95) 1/4" x 1/4" x 1/2" CONTIGUOUS METAL Drip Edge.
- 96) 1/4" x 1/4" x 1/2" CONTIGUOUS METAL Drip Edge.
- 97) 1/4" x 1/4" x 1/2" CONTIGUOUS METAL Drip Edge.
- 98) 1/4" x 1/4" x 1/2" CONTIGUOUS METAL Drip Edge.
- 99) 1/4" x 1/4" x 1/2" CONTIGUOUS METAL Drip Edge.
- 100) 1/4" x 1/4" x 1/2" CONTIGUOUS METAL Drip Edge.

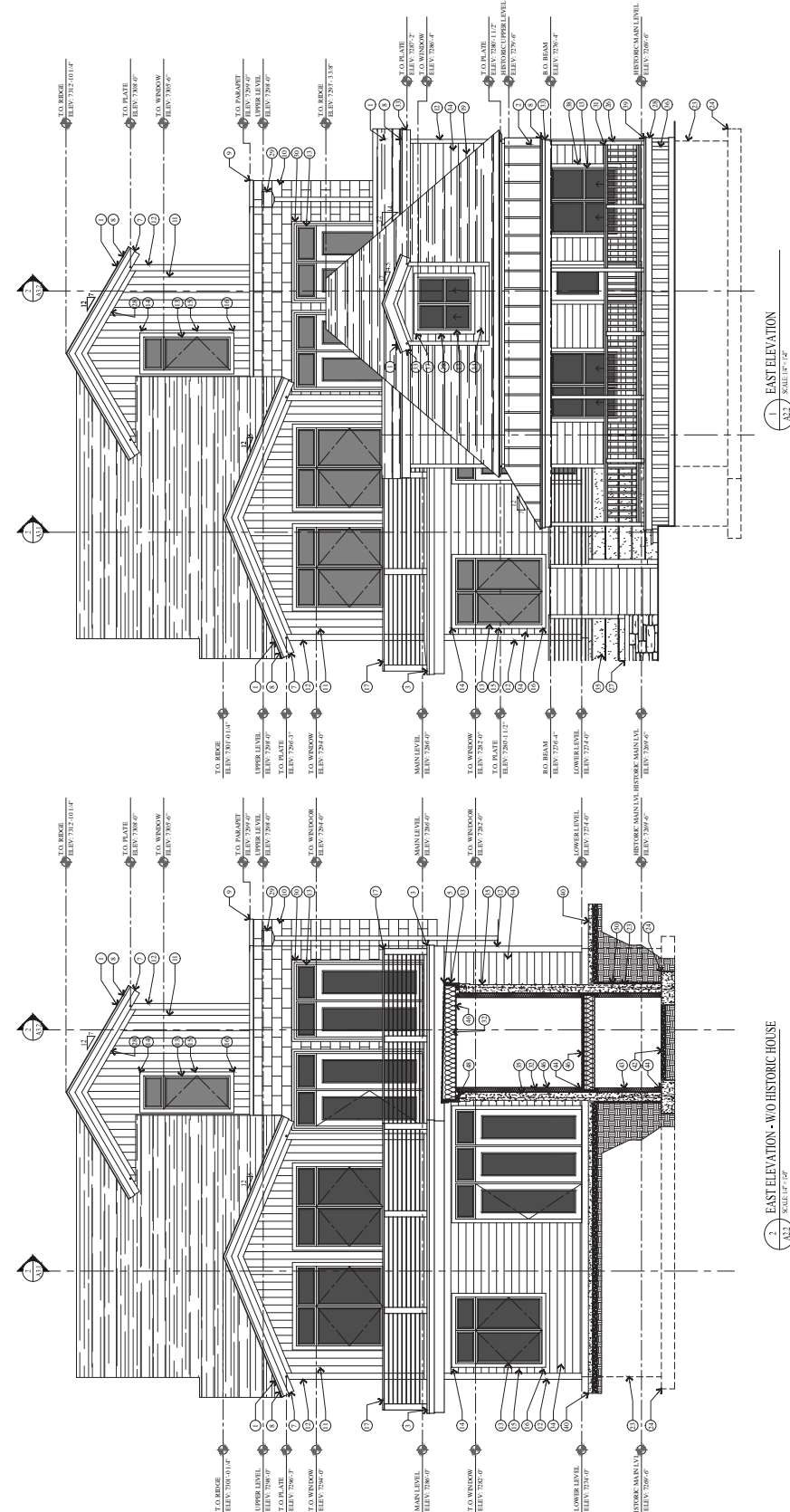

1. EAST ELEVATION  
SCALE: 1/4" = 1'-0"

2. EAST ELEVATION - W/O HISTORIC HOUSE  
SCALE: 1/4" = 1'-0"

THE DRAWING MATERIAL AND DESIGN ON THIS SHEET ARE THE PROPERTY OF JONATHAN DEGRAY ARCHITECT. REPRODUCTION OR USE OF THIS DRAWING WITHOUT THE WRITTEN CONSENT OF JONATHAN DEGRAY ARCHITECT IS PROHIBITED. THE CLIENT'S RESPONSIBILITY IS TO OBTAIN ALL NECESSARY PERMITS AND APPROVALS FROM THE APPLICABLE AGENCIES AND AUTHORITIES. THE ARCHITECT ASSUMES NO LIABILITY FOR THE ACCURACY OF THE INFORMATION PROVIDED BY THE CLIENT OR FOR THE RESULTS OF ANY INVESTIGATION OR ANALYSIS CONDUCTED BY THE ARCHITECT.



SOUTH ELEVATION

115 SAMPSON AVENUE RESIDENCE  
HISTORIC DISTRICT DESIGN REVIEW SET

Jonathan Degray  
Architect  
P.O. Box 1874, 614 Main Street, Suite 202, Park City, Utah 84060  
P: 435-649-7263 E: jon.deggray@questnet.com

KEY NOTES

- 1) EXISTING WALLS TO REMAIN UNLESS NOTED OTHERWISE.
- 2) SHINGLE 50 YEAR PRESIDENTIAL CLASS PER LOCAL CODES AND MANUFACTURER'S RECOMMENDATIONS. MATCH EXISTING MATERIALS AND COLOR. SEE STRUCTURAL FOR SIZE AND SPACING.
- 3) NON-REFLECTIVE STANDING SEAM METAL ROOFING SYSTEM WITH 1/2" MINIMUM OVERLAP. SEE STRUCTURAL FOR SIZE AND SPACING.
- 4) HEATED DECK WATERPROOF MEMBRANE ON 1" POLYETHYLENE GLASS FIBER REINFORCED CONCRETE SLAB. SEE STRUCTURAL FOR SIZE AND SPACING.
- 5) ORIGINAL CONTIGUOUS LINE TO BE DISTRIBUTED TO NEW DECKING.
- 6) EXISTING WATERPROOF MEMBRANE ON 1" POLYETHYLENE GLASS FIBER REINFORCED CONCRETE SLAB. SEE STRUCTURAL FOR DETAILS.
- 7) 1" x 1" CONTIGUOUS METAL Drip Edge.
- 8) 1" x 1" CONTIGUOUS METAL Drip Edge.
- 9) 1" x 1" CONTIGUOUS METAL Drip Edge.
- 10) 1" x 1" CONTIGUOUS METAL Drip Edge.
- 11) 1" x 1" CONTIGUOUS METAL Drip Edge.
- 12) 1" x 1" CONTIGUOUS METAL Drip Edge.
- 13) 1" x 1" CONTIGUOUS METAL Drip Edge.
- 14) 1" x 1" CONTIGUOUS METAL Drip Edge.
- 15) 1" x 1" CONTIGUOUS METAL Drip Edge.
- 16) 1" x 1" CONTIGUOUS METAL Drip Edge.
- 17) 1" x 1" CONTIGUOUS METAL Drip Edge.
- 18) 1" x 1" CONTIGUOUS METAL Drip Edge.
- 19) 1" x 1" CONTIGUOUS METAL Drip Edge.
- 20) 1" x 1" CONTIGUOUS METAL Drip Edge.
- 21) 1" x 1" CONTIGUOUS METAL Drip Edge.
- 22) 1" x 1" CONTIGUOUS METAL Drip Edge.
- 23) 1" x 1" CONTIGUOUS METAL Drip Edge.
- 24) 1" x 1" CONTIGUOUS METAL Drip Edge.
- 25) 1" x 1" CONTIGUOUS METAL Drip Edge.
- 26) 1" x 1" CONTIGUOUS METAL Drip Edge.
- 27) 1" x 1" CONTIGUOUS METAL Drip Edge.
- 28) 1" x 1" CONTIGUOUS METAL Drip Edge.
- 29) 1" x 1" CONTIGUOUS METAL Drip Edge.
- 30) 1" x 1" CONTIGUOUS METAL Drip Edge.
- 31) 1" x 1" CONTIGUOUS METAL Drip Edge.
- 32) 1" x 1" CONTIGUOUS METAL Drip Edge.
- 33) 1" x 1" CONTIGUOUS METAL Drip Edge.
- 34) 1" x 1" CONTIGUOUS METAL Drip Edge.
- 35) 1" x 1" CONTIGUOUS METAL Drip Edge.
- 36) 1" x 1" CONTIGUOUS METAL Drip Edge.
- 37) 1" x 1" CONTIGUOUS METAL Drip Edge.
- 38) 1" x 1" CONTIGUOUS METAL Drip Edge.
- 39) 1" x 1" CONTIGUOUS METAL Drip Edge.
- 40) 1" x 1" CONTIGUOUS METAL Drip Edge.
- 41) 1" x 1" CONTIGUOUS METAL Drip Edge.
- 42) 1" x 1" CONTIGUOUS METAL Drip Edge.
- 43) 1" x 1" CONTIGUOUS METAL Drip Edge.
- 44) 1" x 1" CONTIGUOUS METAL Drip Edge.
- 45) 1" x 1" CONTIGUOUS METAL Drip Edge.
- 46) 1" x 1" CONTIGUOUS METAL Drip Edge.
- 47) 1" x 1" CONTIGUOUS METAL Drip Edge.
- 48) 1" x 1" CONTIGUOUS METAL Drip Edge.
- 49) 1" x 1" CONTIGUOUS METAL Drip Edge.
- 50) 1" x 1" CONTIGUOUS METAL Drip Edge.
- 51) 1" x 1" CONTIGUOUS METAL Drip Edge.
- 52) 1" x 1" CONTIGUOUS METAL Drip Edge.
- 53) 1" x 1" CONTIGUOUS METAL Drip Edge.
- 54) 1" x 1" CONTIGUOUS METAL Drip Edge.
- 55) 1" x 1" CONTIGUOUS METAL Drip Edge.
- 56) 1" x 1" CONTIGUOUS METAL Drip Edge.
- 57) 1" x 1" CONTIGUOUS METAL Drip Edge.
- 58) 1" x 1" CONTIGUOUS METAL Drip Edge.
- 59) 1" x 1" CONTIGUOUS METAL Drip Edge.
- 60) 1" x 1" CONTIGUOUS METAL Drip Edge.
- 61) 1" x 1" CONTIGUOUS METAL Drip Edge.
- 62) 1" x 1" CONTIGUOUS METAL Drip Edge.
- 63) 1" x 1" CONTIGUOUS METAL Drip Edge.
- 64) 1" x 1" CONTIGUOUS METAL Drip Edge.
- 65) 1" x 1" CONTIGUOUS METAL Drip Edge.
- 66) 1" x 1" CONTIGUOUS METAL Drip Edge.
- 67) 1" x 1" CONTIGUOUS METAL Drip Edge.
- 68) 1" x 1" CONTIGUOUS METAL Drip Edge.
- 69) 1" x 1" CONTIGUOUS METAL Drip Edge.
- 70) 1" x 1" CONTIGUOUS METAL Drip Edge.
- 71) 1" x 1" CONTIGUOUS METAL Drip Edge.
- 72) 1" x 1" CONTIGUOUS METAL Drip Edge.
- 73) 1" x 1" CONTIGUOUS METAL Drip Edge.
- 74) 1" x 1" CONTIGUOUS METAL Drip Edge.
- 75) 1" x 1" CONTIGUOUS METAL Drip Edge.
- 76) 1" x 1" CONTIGUOUS METAL Drip Edge.
- 77) 1" x 1" CONTIGUOUS METAL Drip Edge.
- 78) 1" x 1" CONTIGUOUS METAL Drip Edge.
- 79) 1" x 1" CONTIGUOUS METAL Drip Edge.
- 80) 1" x 1" CONTIGUOUS METAL Drip Edge.
- 81) 1" x 1" CONTIGUOUS METAL Drip Edge.
- 82) 1" x 1" CONTIGUOUS METAL Drip Edge.
- 83) 1" x 1" CONTIGUOUS METAL Drip Edge.
- 84) 1" x 1" CONTIGUOUS METAL Drip Edge.
- 85) 1" x 1" CONTIGUOUS METAL Drip Edge.
- 86) 1" x 1" CONTIGUOUS METAL Drip Edge.
- 87) 1" x 1" CONTIGUOUS METAL Drip Edge.
- 88) 1" x 1" CONTIGUOUS METAL Drip Edge.
- 89) 1" x 1" CONTIGUOUS METAL Drip Edge.
- 90) 1" x 1" CONTIGUOUS METAL Drip Edge.
- 91) 1" x 1" CONTIGUOUS METAL Drip Edge.
- 92) 1" x 1" CONTIGUOUS METAL Drip Edge.
- 93) 1" x 1" CONTIGUOUS METAL Drip Edge.
- 94) 1" x 1" CONTIGUOUS METAL Drip Edge.
- 95) 1" x 1" CONTIGUOUS METAL Drip Edge.
- 96) 1" x 1" CONTIGUOUS METAL Drip Edge.
- 97) 1" x 1" CONTIGUOUS METAL Drip Edge.
- 98) 1" x 1" CONTIGUOUS METAL Drip Edge.
- 99) 1" x 1" CONTIGUOUS METAL Drip Edge.
- 100) 1" x 1" CONTIGUOUS METAL Drip Edge.

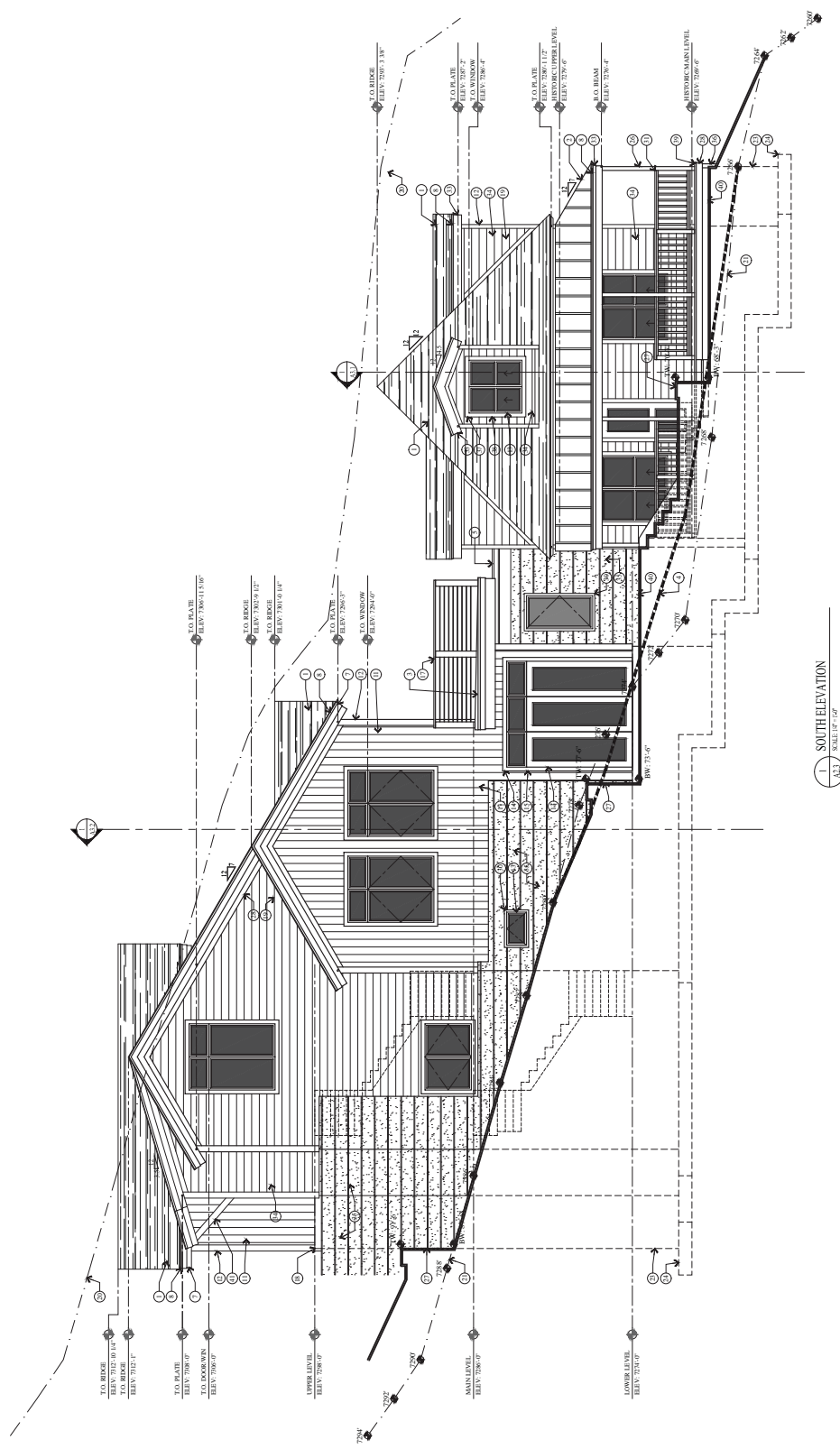

1 SOUTH ELEVATION  
SCALE: 1/8" = 1'-0"

BUILDING SECTIONS

115 SAMPSON AVENUE RESIDENCE  
HISTORIC DISTRICT DESIGN REVIEW SET

Jonathan Degray  
Architect

P.O. Box 1674, 614 Main Street, Suite 202, Park City, Utah 84060  
P: 435-649-7263 E: jon.degray@jonathandegray.com

KEY NOTES

- 1) SHIMBLE SHALL BE USED TO LEVEL UNFINISHED SURFACES TO THE FINISH ELEVATION. SEE STRUCTURAL FOR SIZE AND SPACING.
- 2) ONCE LAMINATE IS APPLIED TO THE SURFACE, THE SURFACE SHALL BE PROTECTED WITH A CLEAR COAT OF POLYURETHANE.
- 3) SEE STRUCTURAL FOR SIZE AND SPACING.
- 4) ROOF METAL SHALL BE TO THE CODE APPROVED.
- 5) ONCE LAMINATE IS APPLIED TO THE SURFACE, THE SURFACE SHALL BE PROTECTED WITH A CLEAR COAT OF POLYURETHANE.
- 6) SEE STRUCTURAL FOR SIZE AND SPACING.
- 7) WOODWORK SHALL BE TO THE CODE APPROVED.
- 8) SLEEPERS ON 1" PLYWOOD ON 1" DECK JOIST.
- 9) CHECK DECK TO BE INTO STORM DRAIN.
- 10) FOOTING ON 1" PLYWOOD ON ROOF JOIST.
- 11) MEMBRANE ON ROOF INSUL. SLOPED 1/4" PER FOOT ON 1" PLYWOOD ON ROOF JOIST.
- 12) 1" x 4" x 1/2" CONTINUOUS METAL DRIPE EDGE.
- 13) 1" x 4" x 1/2" CONTINUOUS METAL DRIPE EDGE.
- 14) METAL PARAPET CAP.
- 15) EXTERIOR FINISH SEE ELEVATIONS FOR TYPES.
- 16) COPPER FLASHING AND GUTTER FLASHING.
- 17) WOODWORK SHALL BE TO THE CODE APPROVED.
- 18) W/ INSULATED GLASS - SEE SCHEDULE.
- 19) 24" WINDOW DOOR HEAD - STAINED W/ METAL FINISH.
- 20) 24" WINDOW DOOR JAMB - STAINED.
- 21) 24" WINDOW DOOR SILL - STAINED.
- 22) 24" WINDOW DOOR FRAME - STAINED.
- 23) 24" WINDOW DOOR FRAME - STAINED.
- 24) 24" WINDOW DOOR FRAME - STAINED.
- 25) 24" WINDOW DOOR FRAME - STAINED.
- 26) 24" WINDOW DOOR FRAME - STAINED.
- 27) 24" WINDOW DOOR FRAME - STAINED.
- 28) 24" WINDOW DOOR FRAME - STAINED.
- 29) 24" WINDOW DOOR FRAME - STAINED.
- 30) 24" WINDOW DOOR FRAME - STAINED.
- 31) 24" WINDOW DOOR FRAME - STAINED.
- 32) 24" WINDOW DOOR FRAME - STAINED.
- 33) 24" WINDOW DOOR FRAME - STAINED.
- 34) 24" WINDOW DOOR FRAME - STAINED.
- 35) 24" WINDOW DOOR FRAME - STAINED.
- 36) 24" WINDOW DOOR FRAME - STAINED.
- 37) 24" WINDOW DOOR FRAME - STAINED.
- 38) 24" WINDOW DOOR FRAME - STAINED.
- 39) 24" WINDOW DOOR FRAME - STAINED.
- 40) 24" WINDOW DOOR FRAME - STAINED.
- 41) 24" WINDOW DOOR FRAME - STAINED.
- 42) 24" WINDOW DOOR FRAME - STAINED.
- 43) 24" WINDOW DOOR FRAME - STAINED.
- 44) 24" WINDOW DOOR FRAME - STAINED.
- 45) 24" WINDOW DOOR FRAME - STAINED.
- 46) 24" WINDOW DOOR FRAME - STAINED.
- 47) 24" WINDOW DOOR FRAME - STAINED.
- 48) 24" WINDOW DOOR FRAME - STAINED.
- 49) 24" WINDOW DOOR FRAME - STAINED.
- 50) 24" WINDOW DOOR FRAME - STAINED.
- 51) 24" WINDOW DOOR FRAME - STAINED.
- 52) 24" WINDOW DOOR FRAME - STAINED.
- 53) 24" WINDOW DOOR FRAME - STAINED.
- 54) 24" WINDOW DOOR FRAME - STAINED.
- 55) 24" WINDOW DOOR FRAME - STAINED.
- 56) 24" WINDOW DOOR FRAME - STAINED.
- 57) 24" WINDOW DOOR FRAME - STAINED.
- 58) 24" WINDOW DOOR FRAME - STAINED.
- 59) 24" WINDOW DOOR FRAME - STAINED.
- 60) 24" WINDOW DOOR FRAME - STAINED.
- 61) 24" WINDOW DOOR FRAME - STAINED.
- 62) 24" WINDOW DOOR FRAME - STAINED.
- 63) 24" WINDOW DOOR FRAME - STAINED.
- 64) 24" WINDOW DOOR FRAME - STAINED.
- 65) 24" WINDOW DOOR FRAME - STAINED.
- 66) 24" WINDOW DOOR FRAME - STAINED.
- 67) 24" WINDOW DOOR FRAME - STAINED.
- 68) 24" WINDOW DOOR FRAME - STAINED.
- 69) 24" WINDOW DOOR FRAME - STAINED.
- 70) 24" WINDOW DOOR FRAME - STAINED.
- 71) 24" WINDOW DOOR FRAME - STAINED.
- 72) 24" WINDOW DOOR FRAME - STAINED.
- 73) 24" WINDOW DOOR FRAME - STAINED.
- 74) 24" WINDOW DOOR FRAME - STAINED.
- 75) 24" WINDOW DOOR FRAME - STAINED.
- 76) 24" WINDOW DOOR FRAME - STAINED.
- 77) 24" WINDOW DOOR FRAME - STAINED.
- 78) 24" WINDOW DOOR FRAME - STAINED.
- 79) 24" WINDOW DOOR FRAME - STAINED.
- 80) 24" WINDOW DOOR FRAME - STAINED.
- 81) 24" WINDOW DOOR FRAME - STAINED.
- 82) 24" WINDOW DOOR FRAME - STAINED.
- 83) 24" WINDOW DOOR FRAME - STAINED.
- 84) 24" WINDOW DOOR FRAME - STAINED.
- 85) 24" WINDOW DOOR FRAME - STAINED.
- 86) 24" WINDOW DOOR FRAME - STAINED.
- 87) 24" WINDOW DOOR FRAME - STAINED.
- 88) 24" WINDOW DOOR FRAME - STAINED.
- 89) 24" WINDOW DOOR FRAME - STAINED.
- 90) 24" WINDOW DOOR FRAME - STAINED.
- 91) 24" WINDOW DOOR FRAME - STAINED.
- 92) 24" WINDOW DOOR FRAME - STAINED.
- 93) 24" WINDOW DOOR FRAME - STAINED.
- 94) 24" WINDOW DOOR FRAME - STAINED.
- 95) 24" WINDOW DOOR FRAME - STAINED.
- 96) 24" WINDOW DOOR FRAME - STAINED.
- 97) 24" WINDOW DOOR FRAME - STAINED.
- 98) 24" WINDOW DOOR FRAME - STAINED.
- 99) 24" WINDOW DOOR FRAME - STAINED.
- 100) 24" WINDOW DOOR FRAME - STAINED.

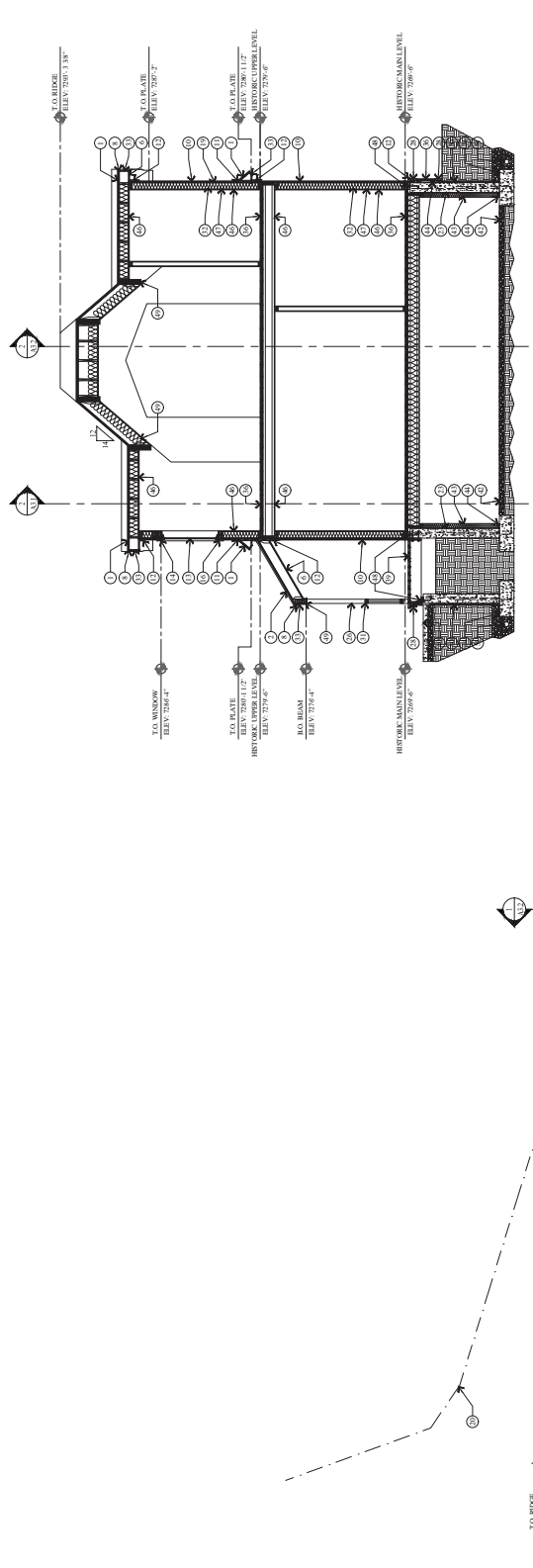

1. BUILDING SECTION  
SCALE 1/4" = 1'-0"

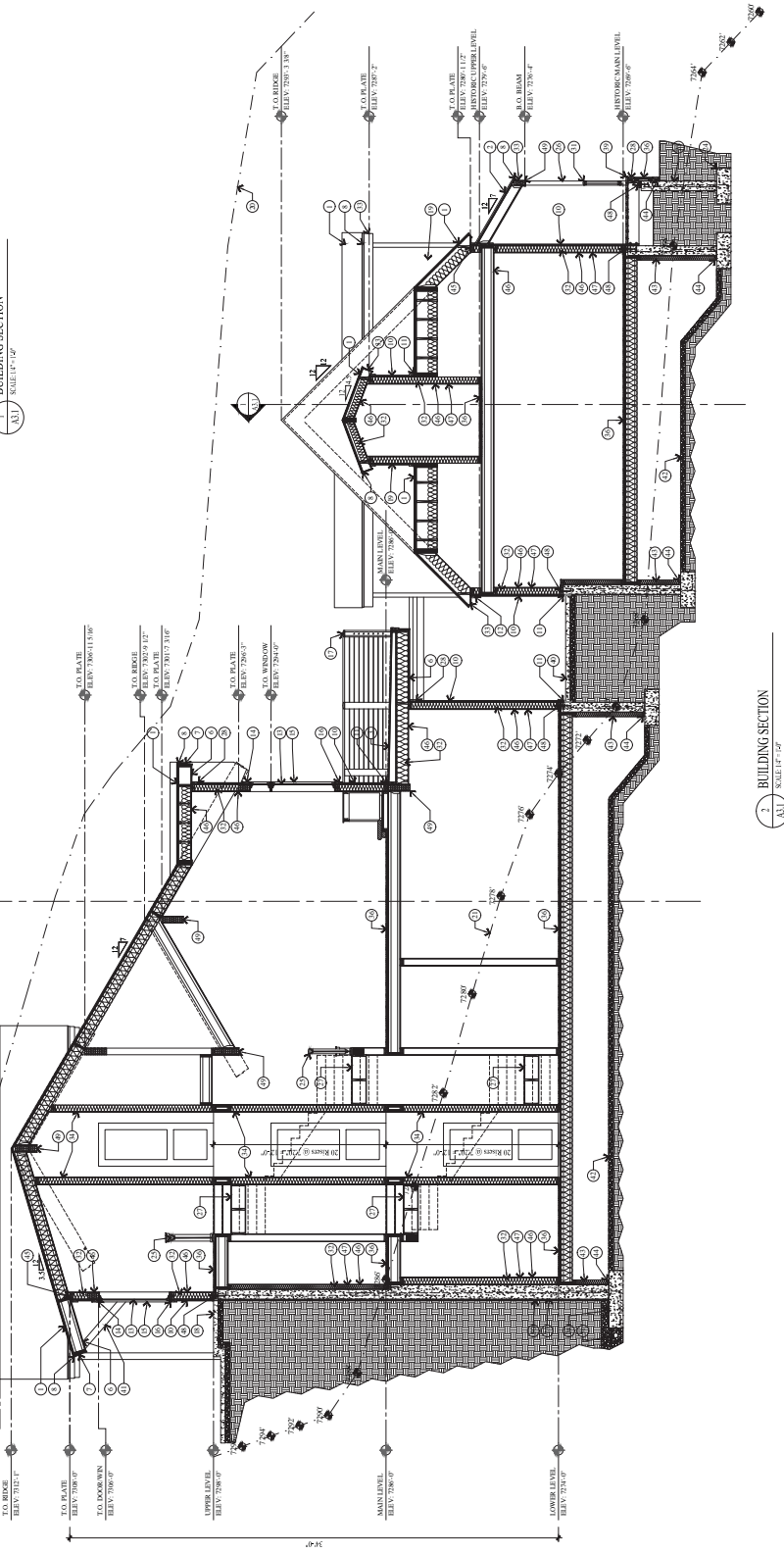

2. BUILDING SECTION  
SCALE 1/4" = 1'-0"

- KEY NOTES**
1. UNLESS OTHERWISE NOTED, ALL DIMENSIONS ARE TO FACE UNLESS INDICATED OTHERWISE.
  2. SINGLE 5/8" X 8" PRESTRESSING TUBES PER SECTION SHALL BE SPACED AT 16" O.C. UNLESS OTHERWISE NOTED.
  3. ALL EXTERIOR WALLS SHALL BE CONCRETE ON A 4" GRAVEL BASE. SEE STRUCTURAL FOR SIZE AND SPACING.
  4. ALL EXTERIOR ROOFING SHALL BE 1/2" THICK ASPHALT/FLY ASH SHINGLES ON 1" X 6" RAFTERS. SEE STRUCTURAL FOR SIZE AND SPACING.
  5. ROOF METAL FLASHING TO BE APPROVED.
  6. ONCE LAMINAR MEMBRANE IS IN PLACE, SEE STRUCTURAL FOR SIZE AND SPACING.
  7. SLEEPERS ON 1/4" PLYWOOD ON 1" DECK JOIST MEMBRANE ON ROOF INSUL. SLOPPED 1/4" PER FOOT ON 1/4" PLYWOOD ON ROOF JOIST.
  8. CHECK DRAIN TO BE INTO STORM DRAIN.
  9. 1/2" X 6" FASCIAS ON ROOF JOIST.
  10. 1/2" X 6" FASCIAS ON ROOF JOIST.
  11. 1/2" X 6" FASCIAS ON ROOF JOIST.
  12. 1/2" X 6" FASCIAS ON ROOF JOIST.
  13. 1/2" X 6" FASCIAS ON ROOF JOIST.
  14. 1/2" X 6" FASCIAS ON ROOF JOIST.
  15. 1/2" X 6" FASCIAS ON ROOF JOIST.
  16. 1/2" X 6" FASCIAS ON ROOF JOIST.
  17. 1/2" X 6" FASCIAS ON ROOF JOIST.
  18. 1/2" X 6" FASCIAS ON ROOF JOIST.
  19. 1/2" X 6" FASCIAS ON ROOF JOIST.
  20. 1/2" X 6" FASCIAS ON ROOF JOIST.
  21. 1/2" X 6" FASCIAS ON ROOF JOIST.
  22. 1/2" X 6" FASCIAS ON ROOF JOIST.
  23. 1/2" X 6" FASCIAS ON ROOF JOIST.
  24. 1/2" X 6" FASCIAS ON ROOF JOIST.
  25. 1/2" X 6" FASCIAS ON ROOF JOIST.
  26. 1/2" X 6" FASCIAS ON ROOF JOIST.
  27. 1/2" X 6" FASCIAS ON ROOF JOIST.
  28. 1/2" X 6" FASCIAS ON ROOF JOIST.
  29. 1/2" X 6" FASCIAS ON ROOF JOIST.
  30. 1/2" X 6" FASCIAS ON ROOF JOIST.
  31. 1/2" X 6" FASCIAS ON ROOF JOIST.
  32. 1/2" X 6" FASCIAS ON ROOF JOIST.
  33. 1/2" X 6" FASCIAS ON ROOF JOIST.
  34. 1/2" X 6" FASCIAS ON ROOF JOIST.
  35. 1/2" X 6" FASCIAS ON ROOF JOIST.
  36. 1/2" X 6" FASCIAS ON ROOF JOIST.
  37. 1/2" X 6" FASCIAS ON ROOF JOIST.
  38. 1/2" X 6" FASCIAS ON ROOF JOIST.
  39. 1/2" X 6" FASCIAS ON ROOF JOIST.
  40. 1/2" X 6" FASCIAS ON ROOF JOIST.
  41. 1/2" X 6" FASCIAS ON ROOF JOIST.
  42. 1/2" X 6" FASCIAS ON ROOF JOIST.
  43. 1/2" X 6" FASCIAS ON ROOF JOIST.
  44. 1/2" X 6" FASCIAS ON ROOF JOIST.
  45. 1/2" X 6" FASCIAS ON ROOF JOIST.
  46. 1/2" X 6" FASCIAS ON ROOF JOIST.
  47. 1/2" X 6" FASCIAS ON ROOF JOIST.
  48. 1/2" X 6" FASCIAS ON ROOF JOIST.
  49. 1/2" X 6" FASCIAS ON ROOF JOIST.
  50. 1/2" X 6" FASCIAS ON ROOF JOIST.
  51. 1/2" X 6" FASCIAS ON ROOF JOIST.
  52. 1/2" X 6" FASCIAS ON ROOF JOIST.
  53. 1/2" X 6" FASCIAS ON ROOF JOIST.
  54. 1/2" X 6" FASCIAS ON ROOF JOIST.
  55. 1/2" X 6" FASCIAS ON ROOF JOIST.
  56. 1/2" X 6" FASCIAS ON ROOF JOIST.
  57. 1/2" X 6" FASCIAS ON ROOF JOIST.
  58. 1/2" X 6" FASCIAS ON ROOF JOIST.
  59. 1/2" X 6" FASCIAS ON ROOF JOIST.
  60. 1/2" X 6" FASCIAS ON ROOF JOIST.
  61. 1/2" X 6" FASCIAS ON ROOF JOIST.
  62. 1/2" X 6" FASCIAS ON ROOF JOIST.
  63. 1/2" X 6" FASCIAS ON ROOF JOIST.
  64. 1/2" X 6" FASCIAS ON ROOF JOIST.
  65. 1/2" X 6" FASCIAS ON ROOF JOIST.
  66. 1/2" X 6" FASCIAS ON ROOF JOIST.
  67. 1/2" X 6" FASCIAS ON ROOF JOIST.
  68. 1/2" X 6" FASCIAS ON ROOF JOIST.
  69. 1/2" X 6" FASCIAS ON ROOF JOIST.
  70. 1/2" X 6" FASCIAS ON ROOF JOIST.
  71. 1/2" X 6" FASCIAS ON ROOF JOIST.
  72. 1/2" X 6" FASCIAS ON ROOF JOIST.
  73. 1/2" X 6" FASCIAS ON ROOF JOIST.
  74. 1/2" X 6" FASCIAS ON ROOF JOIST.
  75. 1/2" X 6" FASCIAS ON ROOF JOIST.
  76. 1/2" X 6" FASCIAS ON ROOF JOIST.
  77. 1/2" X 6" FASCIAS ON ROOF JOIST.
  78. 1/2" X 6" FASCIAS ON ROOF JOIST.
  79. 1/2" X 6" FASCIAS ON ROOF JOIST.
  80. 1/2" X 6" FASCIAS ON ROOF JOIST.
  81. 1/2" X 6" FASCIAS ON ROOF JOIST.
  82. 1/2" X 6" FASCIAS ON ROOF JOIST.
  83. 1/2" X 6" FASCIAS ON ROOF JOIST.
  84. 1/2" X 6" FASCIAS ON ROOF JOIST.
  85. 1/2" X 6" FASCIAS ON ROOF JOIST.
  86. 1/2" X 6" FASCIAS ON ROOF JOIST.
  87. 1/2" X 6" FASCIAS ON ROOF JOIST.
  88. 1/2" X 6" FASCIAS ON ROOF JOIST.
  89. 1/2" X 6" FASCIAS ON ROOF JOIST.
  90. 1/2" X 6" FASCIAS ON ROOF JOIST.
  91. 1/2" X 6" FASCIAS ON ROOF JOIST.
  92. 1/2" X 6" FASCIAS ON ROOF JOIST.
  93. 1/2" X 6" FASCIAS ON ROOF JOIST.
  94. 1/2" X 6" FASCIAS ON ROOF JOIST.
  95. 1/2" X 6" FASCIAS ON ROOF JOIST.
  96. 1/2" X 6" FASCIAS ON ROOF JOIST.
  97. 1/2" X 6" FASCIAS ON ROOF JOIST.
  98. 1/2" X 6" FASCIAS ON ROOF JOIST.
  99. 1/2" X 6" FASCIAS ON ROOF JOIST.
  100. 1/2" X 6" FASCIAS ON ROOF JOIST.

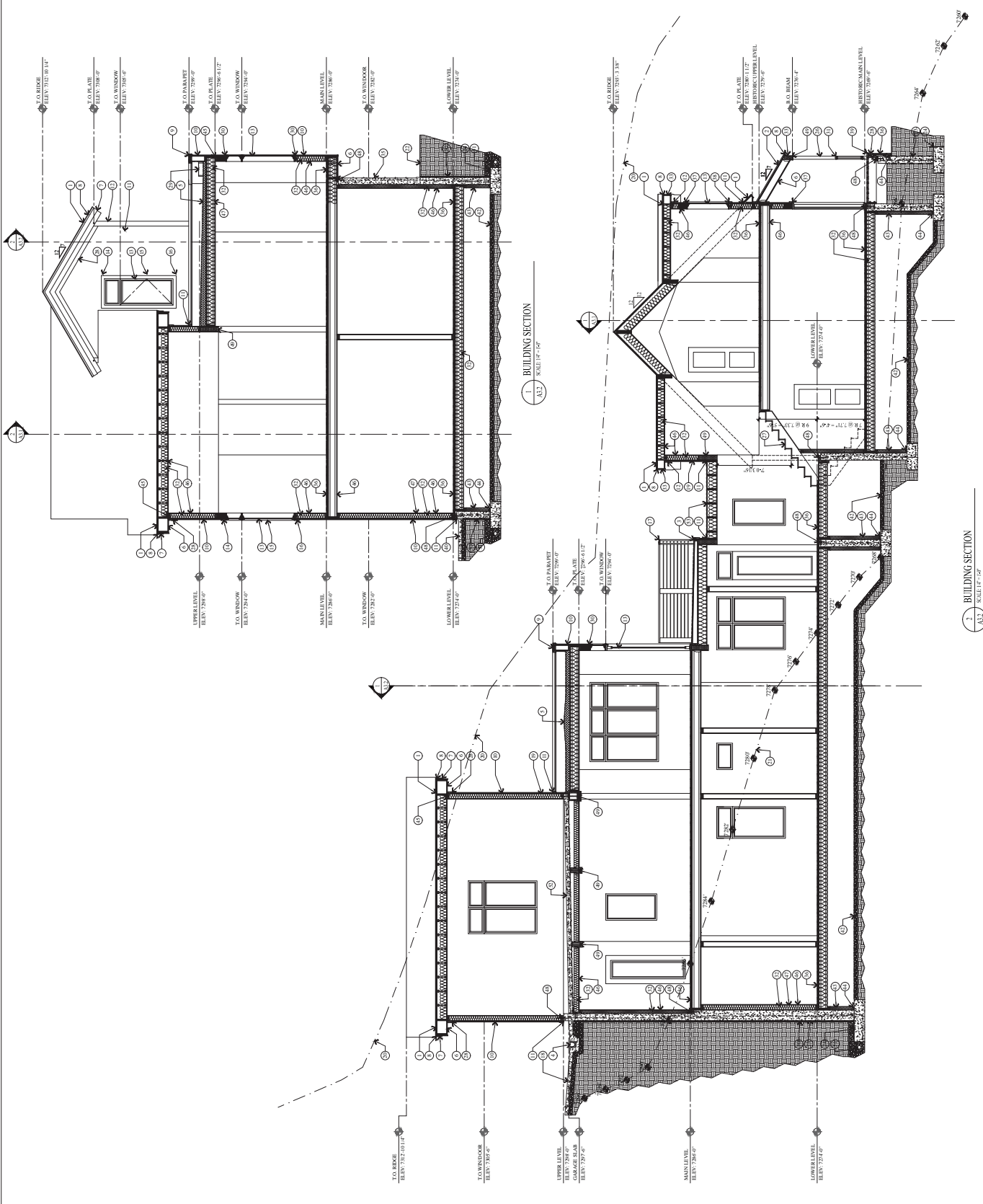

THESE DRAWINGS ARE THE PROPERTY OF JONATHAN DEGRAY ARCHITECT. NO PART OF THESE DRAWINGS SHALL BE REPRODUCED OR TRANSMITTED IN ANY FORM OR BY ANY MEANS, ELECTRONIC OR MECHANICAL, INCLUDING PHOTOCOPYING, RECORDING, OR BY ANY INFORMATION STORAGE AND RETRIEVAL SYSTEM, WITHOUT THE WRITTEN PERMISSION OF JONATHAN DEGRAY ARCHITECT. THE CLIENT'S RESPONSIBILITY IS TO OBTAIN ALL NECESSARY PERMITS AND APPROVALS FROM THE APPROPRIATE AGENCIES. THE ARCHITECT ASSUMES NO LIABILITY FOR CONSTRUCTION DEFECTS OR OMISSIONS. THE ARCHITECT'S RESPONSIBILITY IS LIMITED TO THE DESIGN AND CONSTRUCTION OF THE BUILDING AS SHOWN ON THESE DRAWINGS. THE ARCHITECT DOES NOT WARRANT THE ACCURACY OF ANY INFORMATION PROVIDED BY OTHERS. THE ARCHITECT'S LIABILITY IS LIMITED TO THE DESIGN AND CONSTRUCTION OF THE BUILDING AS SHOWN ON THESE DRAWINGS. THE ARCHITECT DOES NOT WARRANT THE ACCURACY OF ANY INFORMATION PROVIDED BY OTHERS.



Exhibit C



AS SHOWN

STREET SCAPES - EXISTING.

SCALE: 1/8"=1'-0"



AS SHOWN

STREET SCAPES - PROPOSED

SCALE: 1/8"=1'-0"





06/02/2018





06/02/2018





06/02/2018





07/02/2018





07/02/2018





06/02/2018

# Planning Commission Staff Report

**Subject:** Updating codified Historic Sites Inventory to remove the garage at 1503 Park Avenue  
**Author:** Anya Grahn, Historic Preservation Planner  
**Project Number:** PL-18-03830  
**Date:** June 13, 2018  
**Type of Item:** Legislative – LMC Amendment

## Summary Recommendations

Staff recommends the Planning Commission review the proposed Land Management Code Amendments (LMC), conduct a public hearing, and forward a recommendation to City Council to remove the garage at 1503 Park Avenue from the Park City Historic Sites Inventory (HSI), as codified in [LMC 15-11-10 \(D\)\(1\)](#) in accordance with the attached ordinance. No changes are proposed to the designation of the historic house and the site will remain designated as “Landmark” on the City’s Historic Sites Inventory.

## Description

**Project Name:** 1503 Park Avenue/1501 Silver King Drive  
**Applicant:** Dennis Hulbert (Architect Craig Elliot)  
**Owners:** Dennis Hulbert  
**Proposal:** Revisions to the Land Management Code to remove the garage at 1503 Park Avenue from the codified Historic Sites Inventory (HSI) as outlined in LMC 15-11-10(B)(124)

## Reason for Review

On August 3, 2017, City Council approved LMC amendments that codified the Historic Sites Inventory [[Staff Report \(starting page 196\)](#) + [Minutes \(starting page 10\)](#)]. These changes required that the Historic Preservation Board (HPB) forward a recommendation to City Council for applications of Determination of Significance (DOS) that either designate or remove properties to the Historic Sites Inventory (HSI). Additionally, the changes included codifying the list of designated historic sites.

Amending the HSI to remove a site from this list requires an LMC amendment. Amendments to the Land Management Code (LMC) require Planning Commission recommendation and City Council adoption. City Council action may be appealed to a court of competent jurisdiction per Land Management Code (LMC) § 15-1-18.

## Acronyms

DOS Determination of Significance  
HPB Historic Preservation Board  
HSI Historic Sites Inventory  
LMC Land Management Code



## **Background**

On February 4, 2009, the Historic Preservation Board (HPB) approved a resolution adopting the Historic Sites Inventory [[Staff Report](#) (starting page 21) and [Minutes](#) (starting page 3)]. The site at 1503 Park Avenue was one of over 400 buildings nominated to the HSI that day. It was designated as “Landmark” and found to contribute to the Mature Mining Era (1894-1930), as indicated in the [Historic Site Form](#). The HSI identified both the house and garage as historic on the site form.

On March 28, 2018, the owner, Dennis Hulbert, submitted an application for a Determination of Significance for this site; the application was deemed complete on April 5, 2018. Per [LMC 15-11-10\(B\)](#), any Owner of a Building (main, attached, detached or public), Accessory Building, and/or Structure, may nominate it for listing in the Park City Historic Sites Inventory. The Planning Department may nominate a Building (main, attached, detached or public), Accessory Building, and/or Structure for listing in the Park City Historic Sites Inventory. The City Council shall make the final determination on all Determination of Significance applications considering the criteria outlined in LMC 15-11-10(A).

The Historic Preservation Board (HPB) reviewed the applicant’s request for a DOS application to remove the garage at 1503 Park Avenue site from the Historic Sites Inventory (HSI) on May 16, 2018 [[Staff Report \(starting page 57\)](#) and Draft Minutes (Exhibit B)]. The HPB found that the garage structure did not meet the criteria to be designated as Landmark on the HSI as it did not individually contribute to the historical significance of the site and its surroundings related to the Mature Mining Era (1894-1930) of which the site is designated as historic nor the Mining Decline and Emergence of Recreation Industry Era (1931-1962) in which the garage was built. The HPB voted 4 to 1 to remove the garage from the Historic Sites Inventory.

The site will remain designated as Landmark on the City’s Historic Sites Inventory and no changes are proposed to the house’s designation. Only the garage will be removed from the Historic Sites Inventory.

## **Analysis**

The following redlines reflect the removal of the garage at 1503 Park Avenue from the City’s codified HSI in [LMC 15-11-10](#).

### 15-11-10 Park City Historic Sites Inventory

*(D) Properties identified on the Historic Sites Inventory are hereby designated by Ordinance as Landmark or Significant. These properties include:*

*(1) Landmark*

*(. . .)*

*Et. 1503 Park Avenue (does not include garage)*

*(. . .)*

## *(2) Significant*

### **Process**

Amendments to the Land Management Code require Planning Commission recommendation and City Council adoption. City Council action may be appealed to a court of competent jurisdiction per LMC § 15-1-18.

### **Department Review**

This report has been reviewed by the City's Planning, Engineering, and Legal Departments.

### **Notice**

Legal notice of a public hearing was posted in the required public spaces and public notice websites on May 2, 2018 and published in the Park Record on May 5 and May 26, 2018 per the requirements of the Land Management Code. Staff also posted a public notice on the property and sent a mailing notice to the property owner and property owners May 2, 2018.

### **Public Input**

Public hearings are required to be conducted by the Planning Commission and City Council prior to adoption of Land Management Code amendments. Staff has noticed this item for public hearings on May 16, 2018 conducted by the Historic Preservation Board, and June 13, 2018, conducted by the Planning Commission and a public hearing on June 21, 2018 to be conducted by City Council. No public comment has been received at this time.

### **Summary Recommendations**

Staff recommends the Planning Commission review the proposed Land Management Code Amendment (LMC), conduct a public hearing, and forward a recommendation to City Council to remove the garage at 1503 Park Avenue from the Park City Historic Sites Inventory (HSI), as codified in [LMC 15-11-10 \(D\)\(1\)](#) in accordance with the attached ordinance. No changes are proposed to the designation of the historic house and the site will remain designated as "Landmark" on the City's Historic Sites Inventory.

### **Exhibits**

Exhibit A – Draft Ordinance

Exhibit B – Draft HPB Minutes, 5.16.18

**Exhibit 1 – Draft Ordinance**

**Ordinance No. 2018-XX**

**AN ORDINANCE AMENDING THE LAND MANAGEMENT CODE OF PARK CITY, UTAH, AMENDING MASTER PLANNED DEVELOPMENTS, CHAPTER 15-11-10(D)(1).**

WHEREAS, the Land Management Code was adopted by the City Council of Park City, Utah to promote the health, safety and welfare of the residents, visitors, and property owners of Park City; and

WHEREAS, the Land Management Code seeks to preserve the City's unique Historic character and to encourage compatible design and construction through the creation of comprehensive list of historic resources known as the Historic Sites Inventory;

WHEREAS, the City reviews the Land Management Code on a regular basis and identifies necessary amendments to address planning and zoning issues that have come up; and

WHEREAS, Park City has an interest in the preservation of the integrity of the Historic Districts as it relates to the historic feel and character, traditional rhythm and scale, and National Register Historic District designations. The Historic District reflects the history of Park City.

WHEREAS, the Historic Preservation Board and City Council have found that garage at 1503 Park Avenue does not meet the criteria to be designated as Landmark on the City's Historic Sites Inventory in accordance with Land Management Code 15-11-10(D); and

WHEREAS, the Historic Preservation Board duly noticed and conducted public hearing at the regularly scheduled meeting on May 16, 2018, and forwarded a positive recommendation to City Council to remove the garage at 1503 Park Avenue from the Historic Sites Inventory; and

WHEREAS, the Planning Commission duly noticed and conducted public hearing at the regularly scheduled meeting on June 6, 2018, and forwarded a \_\_\_\_\_ recommendation to City Council; and

WHEREAS, the City Council duly noticed and conducted a public hearing at its regularly scheduled meeting on June 21, 2018; and

WHEREAS, it is in the best interest of the residents of Park City, Utah to amend the Land Management Code to be consistent with the values and goals of the Park City General Plan and the Park City Council; to preserve and protect the vitality, attractiveness, activity and success of the Historic Districts; to ensure compatible

development; to preserve historic resources; and to preserve the community's unique character.

NOW, THEREFORE, BE IT ORDAINED by the City Council of Park City, Utah as follows:

SECTION 1. APPROVAL OF AMENDMENTS TO TITLE 15 - Land Management Code Chapter 15-11. Historic Preservation. The recitals above are incorporated herein as findings of fact. Chapter 15-11-10(D) of the Land Management Code of Park City is hereby amended as redlined in Exhibit A.

SECTION 2. EFFECTIVE DATE. This Ordinance shall be effective upon publication.

PASSED AND ADOPTED this \_\_\_\_ day of \_\_\_\_\_, 2018

PARK CITY MUNICIPAL CORPORATION

\_\_\_\_\_  
Andy Beerman, Mayor

Attest:

\_\_\_\_\_  
City Recorder

Approved as to form:

\_\_\_\_\_  
Mark Harrington, City Attorney

**Exhibits**

Exhibit A – LMC § 15-11-10(D) Park City Historic Sites Inventory



## Exhibit A – LMC § 15-11-10(D) Park City Historic Sites Inventory

### 15-11-10 Park City Historic Sites Inventory

The City Council may designate Sites to the Historic Sites Inventory as a means of providing recognition to and encouraging the Preservation of Historic Sites in the community. City Council shall make the final determination on all Determination of Significance applications considering the criteria below, with the recommendation of the Historic Preservation Board.

#### A. CRITERIA FOR DESIGNATING SITES TO THE PARK CITY HISTORIC SITES INVENTORY.

1. **LANDMARK SITE.** Any Buildings (main, attached, detached, or public), Accessory Buildings, and/or Structures may be designated to the Historic Sites Inventory as a Landmark Site if the City Council, with a recommendation from the Historic Preservation Board, considers all the criteria listed below:
  - a. It is at least fifty (50) years old or if the Site is of exceptional importance to the community; and
  - b. It retains its Historic Integrity in terms of location, design, setting, materials, workmanship, feeling and association as defined by the National Park Service for the National Register of Historic Places; and
  - c. It is significant in local, regional or national history, architecture, engineering or culture associated with at least one (1) of the following:
    - (1) An era that has made a significant contribution to the broad patterns of our history; or
    - (2) The lives of Persons significant in the history of the community, state, region, or nation; or
    - (3) The distinctive characteristics of type, period, or method of construction or the work of a notable architect or master craftsman.
  
2. **SIGNIFICANT SITE.** Any Buildings (main, attached, detached or public), Accessory Buildings and/or Structures may be designated to the Historic Sites Inventory as a Significant Site if the City Council, with a recommendation from the Historic Preservation Board, considers all the criteria listed below:
  - a. It is at least fifty (50) years old or the Site is of exceptional importance to the community; and
  - b. It retains its Essential Historic Form as may be demonstrated but not limited by any of the following:

- (1) It previously received a historic grant from the City; or
  - (2) It was previously listed on the Historic Sites Inventory; or
  - (3) It was listed as Significant on any reconnaissance or intensive level survey of historic resources; and
- c. It has one (1) or more of the following:
    - (1) It retains its historic scale, context, materials in a manner and degree which can be restored to its Essential Historic Form even if it has non-historic additions; or
    - (2) It reflects the Historical or Architectural character of the site or district through design characteristics such as mass, scale, composition, materials, treatment, cornice, and/or other architectural features as are Visually Compatible to the Mining Era Residences National Register District even if it has non-historic additions; and
  - d. It is important in local or regional history architecture, engineering, or culture associated with at least one (1) of the following:
    - (1) An era of Historic Importance to the community, or
    - (2) Lives of Persons who were of Historic importance to the community, or
    - (3) Noteworthy methods of construction, materials, or craftsmanship used during the Historic period.
3. **CONTRIBUTORY SITE.** Any Buildings (main, attached, detached or public), Accessory Buildings and/or Structures may be designated to the Historic Sites Inventory as a Contributory Site if the City Council, with a recommendation from the Planning Department, considers all the criteria listed below:
- a. The structure is forty (40) years old or older (this includes buildings not historic to Park City that were relocated to prevent demolition); and
  - b. Meets one of the following:
    - (1) Expresses design characteristics such as mass, scale, composition, materials, treatment, cornice, and/or other architectural features as are Visually Compatible to the Mining Era Residences National Register District; or
    - (2) It is important in local or regional history, architecture, engineering, or culture associated with at least one (1) of the following:
      - (A) An era of Historic importance to the community; or
      - (B) Lives of Persons who were of Historic importance to the community, or
      - (C) Noteworthy methods of construction, materials, or craftsmanship used during the Historic Period

- c. Contributory structures may be eligible for Historic District Grant funding. Contributory structures are eligible for demolition.
4. Any Development involving the Reassembly or Reconstruction of a Landmark Site or a Significant Site that is executed pursuant to Sections 15-11-14 or 15-11-15 of this code shall remain on the Park City Historic Sites Inventory. Following Reassembly or Reconstruction, the City Council, with a recommendation from the Historic Preservation Board, will review the project to determine if the work has required a change in the site or structure's historic designation from Landmark to Significant.

**B. PROCEDURE FOR DESIGNATING SITES TO THE PARK CITY HISTORIC SITES INVENTORY.**

The Planning Department shall maintain an inventory of Historic Sites which reflects the Historic Sites Inventory adopted herein. It is hereby declared that all Buildings (main, attached, detached or public), Accessory Buildings, and/or Structures within Park City, which City Council considers to be in compliance with the criteria found in Sections 15-11-10(A)(1) or 15-11-10(A)(2) are determined to be on the Park City Historic Sites Inventory.

Any Owner of a Building (main, attached, detached or public), Accessory Building, and/or Structure, may nominate it for listing in the Park City Historic Sites Inventory. The Planning Department may nominate a Building (main, attached, detached or public), Accessory Building, and/or Structure for listing in the Park City Historic Sites Inventory. The nomination and designation procedures are as follows:

1. **COMPLETE APPLICATION.** The Application shall be on forms as prescribed by the City and shall be filed with the Planning Department. Upon receiving a Complete Application for designation, the Planning staff shall schedule a hearing before the Historic Preservation Board within ninety (90) days.
2. **NOTICE.** Prior to taking action on the Application, the Planning staff shall provide public notice pursuant to Section 15-1-21 of this Code.
3. **HEARING AND DECISION.** The Historic Preservation Board will hold a public hearing and will review the Application for compliance with the "Criteria for Designating Historic Sites to the Park City Historic Sites Inventory." If the Historic Preservation Board finds that the Application complies with the criteria set forth in Section 15-11-10(A)(1) or Section 15-11-10(A)(2), the Building (main, attached, detached or public), Accessory Building, and/or Structure will be recommended to the City Council to be added to the Historic Sites Inventory.

**C. REMOVAL OF A SITE FROM THE PARK CITY HISTORIC SITES INVENTORY.**

The City Council, with a recommendation from the Historic Preservation Board, may remove a Site from the Historic Sites Inventory. Any Owner of a Site listed on the Park City Historic Sites Inventory may submit an Application for the removal of his/her Site from the Park City Historic Sites Inventory. The Planning Department may submit an Application for the removal of a Site from the Park City Historic Sites Inventory. The criteria and procedures for removing a Site from the Park City Historic Sites Inventory are as follows:

**1. CRITERIA FOR REMOVAL.**

- a. The Site no longer meets the criteria set forth in Section 15-11-10(A)(1) or 15-11-10(A)(2) because the qualities that caused it to be originally designated have been lost or destroyed; or
- b. The Building (main, attached, detached, or public) Accessory Building, and/or Structure on the Site has been demolished and will not be reconstructed; or
- c. Additional information indicates that the Building, Accessory Building, and/or Structure on the Site do not comply with the criteria set forth in Section 15-11-10(A)(1) or 15-11-10(A)(2).

**2. PROCEDURE FOR REMOVAL.**

- a. **Complete Application.** The Application shall be on forms as prescribed by the City and shall be filed with the Planning Department. Upon receiving a Complete Application for removal, the Planning staff shall schedule a hearing before the Historic Preservation Board within ninety (90) days.
- b. **Notice.** Prior to taking action on the Application, the Planning staff shall provide public notice pursuant to Section 15-1-21 of this Code.
- c. **Hearing and Decision.** The Historic Preservation Board will hear testimony from the Applicant and public and will review the Application for compliance with the "Criteria for Designating Historic Sites to the Park City Historic Sites Inventory." The HPB shall review the Application "de novo" giving no deference to the prior determination. The Applicant has the burden of proof in removing the Site from the inventory. The HPB will make a recommendation to City Council. The City Council will consider and determine whether the proposal complies with the criteria set forth in Section 15-11-10(A)(1) or Section 15-11-10(A)(2), the Building (main, attached, detached, or public) Accessory Building, and/or Structure will be removed from the Historic Sites Inventory.

D. Properties identified on the Historic Sites Inventory are hereby designated by Ordinance as Landmark or Significant. These properties include:

(1) Landmark

- a. 44 Chambers Street
- b. 64 Chambers Street
- c. 732 Crescent Tram
- d. 61 Daly Avenue
- e. 118 Daly Avenue
- f. 131 Daly Avenue
- g. 142 Daly Avenue
- h. 145 Daly Avenue

- i. 162 Daly Avenue
- j. 166 Daly Avenue
- k. 243 Daly Avenue
- l. 279 Daly Avenue
- m. 314 Daly Avenue
- n. 830 Empire Avenue
- o. 835 Empire Avenue
- p. 911 Empire Avenue
- q. 939 Empire Avenue
- r. 270 Grant Avenue
- s. 27 Hillside Avenue
- t. 3000 Highway 224
- u. 2780 Kearns Boulevard
- v. 33 King Road
- w. 45 King Road
- x. 69 King Road
- y. 74 King Road
- z. 1400 Lucky John Drive
- aa. 125 Main Street
- ab. 140 Main Street
- ac. 150 Main Street
- ad. 151 Main Street
- ae. 170 Main Street
- af. 176 Main Street
- ag. 221 Main Street
- ah. 305 Main Street
- ai. 306 Main Street
- aj. 309 Main Street
- ak. 312 Main Street
- al. 322 Main Street
- am. 328 Main Street
- an. 350 Main Street
- ao. 361-363 Main Street
- ap. 368 Main Street
- aq. 402 Main Street
- ar. 405 Main Street
- as. 419 Main Street
- at. 427 Main Street
- au. 430 Main Street
- av. 434 Main Street
- aw. 436 Main Street
- ax. 438 Main Street
- ay. 440 Main Street
- az. 447 Main Street
- ba. 508 Main Street
- bb. 509 Main Street
- bc. 511 Main Street
- bd. 523 Main Street
- be. 528 Main Street
- bf. 540 Main Street
- bg. 541 Main Street
- bh. 550 Main Street
- bi. 562 Main Street
- bj. 573 Main Street
- bk. 586 Main Street
- bl. 660 Main Street
- bm. 252 Marsac Avenue
- bn. 334 Marsac Avenue
- bo. 342 Marsac Avenue
- bp. 412 Marsac Avenue
- bq. 416 Marsac Avenue
- br. 445 Marsac Avenue
- bs. 243 McHenry Avenue
- bt. 2414 Monitor Drive
- bu. 143 Norfolk Avenue
- bv. 802 Norfolk Avenue
- bw. 811 Norfolk Avenue
- bx. 823 Norfolk Avenue
- by. 824 Norfolk Avenue
- bz. 843 Norfolk Avenue
- ca. 902 Norfolk Avenue
- cb. 933 Norfolk Avenue
- cc. 945 Norfolk Avenue
- cd. 946 Norfolk Avenue
- ce. 955 Norfolk Avenue
- cf. 962 Norfolk Avenue
- cg. 1002.5 Norfolk Avenue
- ch. 1003 Norfolk Avenue
- ci. 1101 Norfolk Avenue
- cj. 1102 Norfolk Avenue
- ck. 264 Ontario Avenue
- cl. 316 Ontario Avenue
- cm. 323 Ontario Avenue
- cn. 355 Ontario Avenue
- co. 413 Ontario Avenue
- cp. 417 Ontario Avenue
- cq. 44 Ontario Canyon Street
- cr. 121 Park Avenue
- cs. 139 Park Avenue
- ct. 157 Park Avenue
- cu. 161 Park Avenue
- cv. 259 Park Avenue

cw. 323 Park Avenue  
cx. 325 Park Avenue  
cy. 343 Park Avenue  
cz. 351 Park Avenue  
da. 363 Park Avenue  
db. 401 Park Avenue  
dc. 402 Park Avenue  
dd. 416 Park Avenue  
de. 421 Park Avenue  
df. 424 Park Avenue  
445 Park Avenue  
dg. 455 Park Avenue  
dh. 463 Park Avenue  
di. 502 Park Avenue  
dj. 517 Park Avenue  
dl. 525 Park Avenue  
dm. 527 Park Avenue  
dn. 528 Park Avenue  
do. 539 Park Avenue  
dp. 543 Park Avenue  
dq. 553 Park Avenue  
dr. 606 Park Avenue  
ds. 610 Park Avenue  
dt. 614 Park Avenue  
du. 638 Park Avenue  
dv. 651 Park Avenue  
dw. 690 Park Avenue  
dx. 698 Park Avenue  
dy. 703 Park Avenue  
dz. 943 Park Avenue  
ea. 959 Park Avenue  
eb. 1021 Park Avenue  
ec. 1049 Park Avenue  
ed. 1062 Park Avenue  
ee. 1063 Park Avenue  
ef. 1119 Park Avenue  
eg. 1124 Park Avenue  
eh. 1125 Park Avenue  
ei. 1128 Park Avenue  
ej. 1141 Park Avenue  
ek. 1150 Park Avenue  
el. 1209 Park Avenue  
em. 1215 Park Avenue  
en. 1255 Park Avenue

eo. 1280 Park Avenue  
ep. 1301 Park Avenue  
eq. 1304 Park Avenue  
er. 1328 Park Avenue  
es. 1354 Park Avenue  
et. 1503 Park Avenue (does not include garage)  
eu. 14 Prospect Street  
ev. 22 Prospect Street  
ew. 36 Prospect Street  
ex. 51 Prospect Street  
ey. 57 Prospect Street  
ez. 59 Prospect Street  
fa. 68 Prospect Street  
fb. 101 Prospect Street  
fc. 622 Rossie Hill Drive  
fd. 652 Rossie Hill Drive  
fe. 660 Rossie Hill Drive  
ff. 41 Sampson Avenue  
fg. 222 Sandridge Road  
fh. 39 Seventh Street  
fi. 41 Seventh Street  
fj. Glenwood Cemetery  
fk. 147 Swede Alley  
fl. 1895 Three Kings Drive  
fm. 109 Woodside Avenue  
fn. 232 Woodside Avenue  
fo. 335 Woodside Avenue  
fp. 564 Woodside Avenue  
fq. 655 Woodside Avenue  
fr. 817 Woodside Avenue  
fs. 839 Woodside Avenue  
ft. 901 Woodside Avenue  
fu. 951 Woodside Avenue  
fv. 1010 Woodside Avenue  
fw. 1026 Woodside Avenue  
fx. 1057 Woodside Avenue  
fy. 1060 Woodside Avenue  
fz. 1100 Woodside Avenue  
ga. 1110 Woodside Avenue  
gb. 1127 Woodside Avenue  
gc. 1162 Woodside Avenue  
gd. 1167 Woodside Avenue

(2) Significant

a. 5 Daly Avenue  
b. 10 Daly Avenue  
c. 24 Daly Avenue  
d. 71 Daly Avenue  
e. 81 Daly Avenue  
f. 97 Daly Avenue  
g. 124 Daly Avenue  
h. 161 Daly Avenue  
i. 167 Daly Avenue  
j. 172 Daly Avenue  
k. 173 Daly Avenue  
l. 180 Daly Avenue  
m. 187 Daly Avenue  
n. 199 Daly Avenue  
o. 239 Daly Avenue  
p. 255 Daly Avenue  
q. 257 Daly Avenue  
r. 269 Daly Avenue  
s. 291 Daly Avenue  
t. 297 Daly Avenue  
u. 309 Daly Avenue  
v. 360 Daly Avenue  
w. 555 Deer Valley Drive  
x. 560 Deer Valley Drive  
y. 577 Daly Avenue  
z. 595 Deer Valley Loop Road  
aa. 632 Deer Valley Loop Road  
ab. 2465 Doc Holiday Drive  
ac. 841 Empire Avenue  
ad. 844 Empire Avenue  
ae. 901 Empire Avenue  
af. 920 Empire Avenue  
ag. 923 Empire Avenue  
ah. 963 Empire Avenue  
ai. 964 Empire Avenue  
aj. 1004 Empire Avenue  
ak. 1011 Empire Avenue  
al. 1013-1015 Empire Avenue  
am. 250 Grant Avenue  
an. 262 Grant Avenue  
ao. 304 Grant Avenue  
ap. 199 Heber Avenue  
aq. 201 Heber Avenue  
ar. 9 Hillside Avenue  
as. 37 Hillside Avenue  
at. 114 Hillside Avenue

au. 3000 HWY 224  
av. 80 King Road  
aw. 81 King Road  
ax. 109 Main Street  
ay. 115 Main Street  
az. 122 Main Street  
ba. 133 Main Street  
bb. 148 Main Street  
bc. 158 Main Street  
bd. 186 Main Street  
be. 227 Main Street  
bf. 268 Main Street  
bg. 347-357 Main Street  
bh. 354 Main Street  
bi. 355-357 Main Street  
bj. 359 Main Street  
bk. 361.5 Main Street  
bl. 408 Main Street  
bm. 412 Main Street  
bn. 442-444 Main Street  
bo. 449 Main Street  
bp. 450 Main Street  
bq. 461-463 Main Street  
br. 510 Main Street  
bs. 515 Main Street  
bt. 556 Main Street  
bu. 558 Main Street  
bv. 591 Main Street  
bw. 220 Marsac Avenue  
bx. 338 Marsac Avenue  
by. 402 Marsac Avenue  
bz. 508 Marsac Avenue  
ca. 257 McHenry Avenue  
cb. 2245 Monitor Drive  
cc. 164 Norfolk Avenue  
cd. 668 Norfolk Avenue  
ce. 713 Norfolk Avenue  
cf. 803 Norfolk Avenue  
cg. 827 Norfolk Avenue  
ch. 835 Norfolk Avenue  
ci. 901 Norfolk Avenue  
cj. 915 Norfolk Avenue  
ck. 1002 Norfolk Avenue  
cl. 1009 Norfolk Avenue  
cm. 1021 Norfolk Avenue  
cn. 1055 Norfolk Avenue

co. 1063 Norfolk Avenue  
cp. 1135 Norfolk Avenue  
cq. 1259 Norfolk Avenue  
cr. 1302 Norfolk Avenue\*  
cs. 308 Ontario Avenue  
ct. 317 Ontario Avenue  
cu. 341 Ontario Avenue  
cv. 405 Ontario Avenue  
cw. 422 Ontario Avenue  
cx. 104 Park Avenue  
cy. 145 Park Avenue  
cz. 263 Park Avenue  
da. 305 Park Avenue  
db. 339 Park Avenue  
dc. 364 Park Avenue  
dd. 411 Park Avenue  
de. 435 Park Avenue  
df. 450 Park Avenue  
dg. 526 Park Avenue  
dh. 527 Park Avenue  
di. 557 Park Avenue  
dj. 561 Park Avenue  
dk. 569 Park Avenue\*  
dl. 575 Park Avenue  
dm. 581 Park Avenue  
dn. 602 Park Avenue  
do. 628 Park Avenue  
dp. 657 Park Avenue  
dq. 801 Park Avenue  
dr. 811 Park Avenue  
ds. 817 Park Avenue  
dt. 820 Park Avenue  
du. 909 Park Avenue  
dv. 915 Park Avenue  
dw. 923 Park Avenue  
dx. 929 Park Avenue  
dy. 937 Park Avenue  
dz. 949 Park Avenue  
ea. 1015 Park Avenue  
eb. 1043 Park Avenue  
ec. 1059 Park Avenue  
ed. 1060 Park Avenue  
ee. 1101 Park Avenue  
ef. 1102 Park Avenue  
eg. 1108 Park Avenue  
eh. 1109 Park Avenue

ei. 1114 Park Avenue  
ej. 1129 Park Avenue  
ek. 1135 Park Avenue  
el. 1149 Park Avenue  
em. 1160 Park Avenue  
en. 1266 Park Avenue  
eo. 1274 Park Avenue  
ep. 1323 Park Avenue  
eq. 1326 Park Avenue  
er. 1333 Park Avenue  
es. 1359 Park Avenue  
et. 1420 Park Avenue  
eu. 1450 Park Avenue  
ev. 1460 Park Avenue  
ew. 1488 Park Avenue  
ex. 9 Prospect Street  
ey. 52 Prospect Street  
ez. 60 Prospect Street  
fa. 147 Ridge Avenue  
fb. 16 Sampson Avenue  
fc. 40 Sampson Avenue  
fd. 60 Sampson Avenue  
fe. 115 Sampson Avenue  
ff. 135 Sampson Avenue  
fg. 130 Sandridge Road  
fh. 152 Sandridge Road  
fi. 164 Sandridge Road  
fj. 218 Sandridge Road  
fk. 228 Sandridge Road  
fl. 224 Sandridge Road  
fm. 175 Snows Lane  
fn. 205 Snows Lane  
fo. 601 Sunnyside Avenue  
fp. 115 Woodside Avenue  
fq. 133 Woodside Avenue  
fr. 139 Woodside Avenue  
fs. 149 Woodside Avenue  
ft. 311 Woodside Avenue  
fu. 316 Woodside Avenue  
fv. 332 Woodside Avenue  
fw. 347 Woodside Avenue  
fx. 359 Woodside Avenue  
fy. 401 Woodside Avenue  
fz. 405 Woodside Avenue  
ga. 424 Woodside Avenue  
gb. 429 Woodside Avenue



gc. 481 Woodside Avenue  
gd. 501 Woodside Avenue  
ge. 505 Woodside Avenue  
gf. 543 Woodside Avenue  
gg. 563 Woodside Avenue  
gh. 605 Woodside Avenue  
gi. 615 Woodside Avenue  
gj. 627 Woodside Avenue  
gk. 633 Woodside Avenue  
gl. 664 Woodside Avenue  
gm. 733 Woodside Avenue  
gn. 805 Woodside Avenue  
go. 823 Woodside Avenue  
gp. 827 Woodside Avenue  
gq. 835 Woodside Avenue  
gr. 905 Woodside Avenue  
gs. 909 Woodside Avenue  
gt. 919 Woodside Avenue

gu. 1002 Woodside Avenue  
gv. 1007 Woodside Avenue  
gw. 1013 Woodside Avenue  
gx. 1020 Woodside Avenue  
gy. 1027 Woodside Avenue  
gz. 1045 Woodside Avenue  
ha. 1053 Woodside Avenue  
hb. 1062 Woodside Avenue  
hc. 1103 Woodside Avenue  
hd. 1107 Woodside Avenue  
he. 1120 Woodside Avenue  
hf. 1147 Woodside Avenue  
hg. 1158 Woodside Avenue  
hh. 1323 Woodside Avenue  
hi. 1439 Woodside Avenue  
hj. 1445 Woodside Avenue  
hk. 1455 Woodside Avenue

### (3) Mining Sites

- a. California Comstock Mine Site—Mill Building and Cabin
- b. Jupiter Mine—Ore Bin and Frame
- c. Daly West Mine—Head Frame and Fire Hydrant Shacks
- d. Alliance Mine – Office/Dwelling, Change Room, and Power House
- e. Silver King Consolidated Spiro Tunnel Complex—Foundry Building, Ivers Tunnel Structure, Spiro Tunnel Portal, Machine Shop Building, Sawmill Building, Water Tank A, and Coal Hopper/Boiler Structure
- f. Judge Mine Site—Assay Office and Change Room Building, Shed Structure, Explosives Bunker Portal, Mine Complex Ruins
- g. Judge Mine Aerial Tramway Towers
- h. Little Bell Mine—Ore Bin
- i. Silver King Tramway Towers
- j. Silver King Mine Site—Boarding House, Boarding House Vault, Change House, Hoist House, Mill Building, Fire Hose Shacks, Stone Wall, Stores Department Building, Transformer House, and Water Tanks
- k. Silver King Consolidated Mine—Ore bin and Counterweight
- l. Thaynes Mine—Conveyor Gallery, Hoist House, Conveyor Gallery, Fire Hydrant Shack, Boarding House Ruins, Accessory Buildings 1 and 2

# Exhibit B

Historic Preservation Board Meeting  
May 16, 2018

5. Within five (5) days of installation of the cribbing and shoring, the structural engineer will inspect and approve the cribbing and shoring as constructed.
  6. Historic buildings which are lifted off the foundation must be returned to the completed foundation within 45 days of the date the building permit was issued.
  7. The Planning Director may make a written determination to extend this period up to 30 additional days if, after consultation with the Historic Preservation Planner, Chief Building Official, and City Engineer, he determines that it is necessary. This would be based upon the need to immediately stabilize an existing Historic property, or specific site conditions such as access, or lack thereof, exist, or in an effort to reduce impacts on adjacent properties.
  8. The applicant is responsible for notifying the Building Department if changes are made. If the cribbing and/or shoring plan(s) are to be altered at any time during the construction of the foundation by the contractor, the structural engineer shall submit a new cribbing and/or shoring plan for review. The structural engineer shall be required to re-inspect and approve the cribbing and/or shoring alterations within five (5) days of any relocation or alteration to the cribbing and/or shoring.
  9. The applicant shall also request an inspection through the Building Department following the modification to the cribbing and/or shoring. Failure to request the inspection will be a violation of the Preservation Plan and enforcement action through the financial guarantee for historic preservation or ACE could take place.
  10. Replacement doors shall exactly match the historic door in size, material, profile, and style.
  11. An independent window evaluation specialist will assess and report on the existing window conditions and outline options for rehabilitation or replacement in satisfaction of the Planning Director.
  12. Should the original wood windows not be able to be restored, the replacement windows shall exactly match the historic window in size, dimensions, glazing pattern, depth, profile, and material.
4. 1503 Park Avenue – Determination of Significance for the proposed removal of a garage listed as Landmark on Park City’s Historic Sites Inventory, per Land Management Code (LMC) 15-11-10(C).  
(Application PL-18-03830)

Planner Grahn reviewed the application for Determination of Significance for a garage structure. This site in Old Town has minimal documented history. Up until the 1930s the site was owned by the Mine Company; and because it was outside of the City limits there are no Sanborn Fire Insurance maps. In addition, it was difficult to trace the ownership because the site had always been owned by the Mine Company. The first actual owner shows up in the 1930 Federal Census. That was an indication that the house was built by 1930. Planner Grahn believed the house was built by 1952, based on an aerial photograph analysis that was done by the preservation consultant. It is a simple, two-car

garage typical to garages built in the 1950s. It has two wood panel garage doors and it sits on a concrete slab foundation. It has 2 x 4 exposed rafters.

Planner Grahn reported that a number of surveys have been completed on this property. When a Reconnaissance or Intensive Level survey is done, the main focus of the survey is the primary use of the site or the building. The house always trumps the accessory building. Planner Grahn noted that there is documented history from these surveys, such as when the house was built, the style, etc. However, for the most part these surveys have ignored the garage. Planner Grahn stated that in 2009, when the current historic site form was created, Dina Blaes, the preservation consultant for that project, just checked the box indicating an accessory building on the site.

Planner Grahn stated that the garage is mentioned in the 2015 CRSA Intensive Level survey, but it did not go into detail other than saying that the garage was at the rear of the house and had space for two cars. It also said that the overall form and material of the building remained intact and the building maintained retained its historic value. Planner Grahn remarked that a concern with these Surveys is the need to be careful about how the accessory buildings are analyzed.

Planner Grahn clarified that the applicant was not proposing to change the designation of the house. They were only looking at the 1952 garage. She reviewed the criteria for whether the garage meets for a Landmark or Significant designation. The first was for Landmark sites, which is the current designation of the site. The first criteria is whether the garage is at least 50 years old and has it achieved significance. Planner Grahn pointed out that the garage is approximately 66 years old. It is not Significant to the Mature Mining Era, which ended around 1930. It is the Era of significance of the historic house, but the garage came much later.

The second criteria is whether it retains its historic integrity. Planner Grahn remarked that the building has not changed much; however, she did not believe it has enough significance or integrity to stand on its own to be individually listed on the National Register of Historic Places. Planner Grahn pointed out that the garage does not contribute to the significance of this site, but it also does not detract.

The third criteria is whether it is significant to local, regional, or national history. Planner Grahn thought the garage was weak in this category and did not comply with the criteria. She stated that it is a double-car garage for a single family dwelling. It matches its intended use as a garage and the use has continued. However, she did not believe it contributes to the understanding of the site or the historical significance of the site. Garages that were built in the 1900s help in understanding the evolution of how cars came to be in Old Town. By the 1950s,

garages were common place in Old Town. It is a detached accessory building that is not indicative of what was occurring when the house was built in 1930.

The fourth criteria is whether the garage has significance based on the lives of the people associated with it. Planner Grahn reported that the garage was likely constructed by Victor Peterson, who was the first tenant of the house. The garage is linked to Mr. Peterson, but she thought the house was a better indication of his contribution to the community.

The fifth criteria is whether the structure is distinctive of a time or period. Planner Grahn noted that the garage was constructed with readily available construction materials and as a concrete slab. It does not contribute to the historical significance of the house that was constructed in 1930 and relates to the Mature Mining Era. If the garage is analyzed separately, there is nothing distinctive or special.

Planner Grahn reviewed the criteria for Significance. She noted that the garage is at least 50 years old and it has its essential historic form. The garage retains its scale and reflects the historic character, and it fits in nicely in Old Town, but that does not mean it is historically significant. Planner Grahn pointed out that the garage does not help talk about understanding the overall Park City history. By 1950 it was common to have cars in Old Town and people built two-car garages to house the two cars they had.

Planner Grahn requested that the HPB consider removing just the garage from the Historic Site Inventory.

The project architect, Craig Elliott, was present to answer questions.

Chair Stephens understood that the garage did not stand on its own historically; and, therefore, it was neither contributory or non-contributory to the house. In looking through all of the surveys, it was apparent that the garage was not researched as historic. Planner Grahn replied that he was correct.

Board Member Hodgkins noted that very few buildings were built in the 1950s time period. He asked what they called that era. Planner Grahn stated that 1932-1962 was the Decline of the Mining Era and the emergence of the Ski Era. They can point to buildings around town, particularly for the Ski Era, that helps understand linking buildings from the Mining Era to the Ski Era. Some buildings speak to the overall decline of the Mining Era, but in her opinion, a two-car garage does not contribute to understanding that Era. Board Member Hodgkins agreed; however, some buildings from that Era have been considered contributory. He understood that this garage was not part of the Mining Era, and even thought it was associated with the decline it is in between two eras.

Chair Stephens gave a scenario of a home similar to the home at 1503 Park Avenue, where the garage appeared to be more contributory and more significant. He asked if the HPB would be in a position to allow them to tear it down, even though it would be more contributory than the one being discussed this evening.

Director Erickson stated that there is a shortage in the criteria for the Mining Decline Rise to the Ski Resort Era. Garages have always been accessory units, but not necessarily contributory. In terms of storytelling the Mining Decline Era, just because a person built a garage does not necessarily make it significant to the Era. Planner Grahm provided an example of a 1960 Ranch house and garage. If someone had built that in Park City, there would be a discussion about how the house and the garage were designed together, how the house and garages relate and some of the design elements.

Chair Stephens asked if there was a 1930s home with a garage that was built in 1939 and architecturally contributory to the house, whether the Staff had the tools to significantly argue that the garage should remain. Planner Grahm thought they would if they could piece it together. Chair Stephens clarified that he did not want to set a precedent that would take away the opportunity to address an accessory building that may be historically significant. Planner Grahm replied that the Staff had the same concern. They did not want to open the door to demolishing or removing the historical significance of 1913 garages from 1895 houses because they do relate and explain how the sites have evolved. This garage was different because by 1950 garages had become commonplace and normal.

Board Member Hutchings wanted to know why being commonplace in the 1950s detracted from the historical significance of the house. Planner Grahm replied that visually it does not detract from the historic house. However, they have look at whether or not the garage itself is historically significant. For example, does it tell something about the history during that time period. She did not believe this garage tells a story. It was not the first of its kind, and the same garage could be built today. Mr. Hutchings noted that all the historic homes were built the same way, but they happen to be 100 years old. Planner Grahm replied that the fact that they are 100 years old makes them unique, and in some cases, they retain or restored their historic integrity. Regarding the question of whether this garage could stand alone and be National Register Eligible and listed as a Landmark site, Planner Grahm was unsure that it could. This garage was built to be a garage and to house cars. It was not contributing to a larger trend that was occurring in the community. Mr. Hutchings thought the trend was that people parked their car in garages. Planner Grahm stated that they could make the finding that the garage is historic because it is 50 years old and reflects the need to have two cars.

Board Member Hodgkins noted that the Mining period and the Ski Industry period were very different periods, but both contributed significantly to the history of the town. The in between period was a decline that led to the ability to redefine itself as a ski area, but by itself it was not necessarily historic in terms of the history of Park City. Mr. Hodgkins understood that the structures that were built during that time were commonplace and could be found anywhere. The post-World War II era and the building boom was not part of Park City's history. Planner Grahn agreed. She pointed out that there was a unique post-war style that evolved and a handful of houses in Park City that were built in that era have retained their integrity and help bridge that gap. The issue is that she did not believe the garage itself helps to bridge the gap. Mr. Hodgkins believed that if this garage was in a different area or neighborhood that was more architecturally historic, they would be having a different discussion. Planner Grahn agreed.

Chair Stephens clarified that 1503 Park Avenue was outside of the formal District. He asked if it was included because it was 50 years old, or because it goes to blocks past that district. Planner Grahn explained that the thematic National Register District extends beyond the historic H zoning districts. This is an example of a historic site that is outside of the H zoning districts. The site itself is historically significant because of the 1930 house on the site that was built during the Mining Era. Chair Stephens pointed out that because the garage is outside of the area, it is surrounded by resort commercial.

Planner Grahn reviewed the Historic Sites Form to determine whether this building was individually listed or if it was listed as part of the overall thematic district. She noted that Ms. Blaes had checked Building/Main. The site is eligible, but not listed on the National Register of Historic Places. The overall site is Landmark because it is eligible for the National Register. Ms. Blaes had checked Building Main, being the house. She then checked Building Accessory, which means the site form encompasses the garage. However, no analysis was done on the garage itself.

Mr. Hutchings understood that an ancillary building, such as a garage, in the Historic District that do not contribute to the Mining Era would not meet the criteria. However, if it was in a neighborhood that was built primarily in the 1950s, then a garage that was built in the 1950s era would likely meet the criteria.

Director Erickson stated that these buildings are considered on a case by case basis. If the same building could be built today and it does not tell a story, the Staff would suggest that it is not historic. On the other hand, if something in the building was unique to the Mining Decline Era, they would probably make sure it remained on the Site Inventory as Significant. If there is something unique in the architectural detailing, they would also recommend keeping it on the HSI. Director Erickson noted that the HPB will have a longer and more in-depth



discussion when they talk about the A-frames and the Pregnant A-frames moving forward in the Mining Decline Era. He reiterated all the reasons why the Staff believed that this garage was not Significant.

Board Member Hutchings asked if there was another 1950s garage that was built in the Historic District that they would recommend keeping on the Inventory. Planner Grahn thought that was a good question, but she had not analyzed the rest of the list to make that determination. The Staff would have to analyze each individual accessory building since they were not specifically called out on the HSI forms.

Chair Stephens was comfortable with the Staff recommendation. He only wanted to make sure that they could manage the expectation when the next applicant comes in with a request to tear down a garage or outbuilding. If the Planning Department had the tools to successfully make that argument when it is appropriate and can bring those discussions to the HPB, he had no issues with this request. Director Erickson stated that if it is on a designated site, the default condition is that it is Significant, unless evidence points to the contrary. In this case, they believed it points to the contrary. Planner Grahn remarked that she relied heavily on the historic preservation consultant and on Oliver who does the National Register Nominations on a daily basis because this was a unique site. The Staff wanted to make sure they were setting up a position to lose all the garages on Daly Avenue or something more drastic that would impact the District.

Board Member Beatlebrox was reminded of the house in the middle of Crescent Tram. It was a classic form from the Mining Era that had many additions that were added by Carl Winters, who was very important to the town. She recalled that the additions were so poorly constructed that the Board agreed that they did not add to the historic form and could be removed. Planner Grahn emphasized that the additions did not contribute to the historic form and the overall look and feel of the house, and actually detracted from it. Board Member Hodgkins added that part of their determination was that the historic nature of the house was evident even with the additions missing.

Board Member Beatlebrox was not opposed to removing the garage.

Chair Stephens opened the public hearing.

There were no comments.

Chair Stephens closed the public hearing.

**MOTION:** Board Member Holmgren moved to remove the designation of the garage at 1503 Park Avenue as a Landmark Structure from the Park City Historic

Sites Inventory, subject to the Findings of Fact, Conclusions of Law found in the Staff report. Board Member Beatlebrox seconded the motion.

VOTE: The motion passed 4-1. Board Member Hutchings voted against the motion.

#### Findings of Fact – 1503 Park Avenue

1. The property is located at 1503 Park Avenue, in the Recreation Commercial (RC) zoning district.
2. There is little evidence to trace the history and ownership of this property. Until 1935, the site was owned by the Ontario Mining Company and the location of the site was outside of the original Park City Survey. It was not documented by Sanborn Fire Insurance Maps. No historic photographs or tax assessments are available for this site.
3. The 1930 Federal Census shows that Victor and Jennie Peterson lived at this address and title research shows they purchased the site in 1935. Victor Peterson was a University of Utah graduate and teacher in the Park City School District for over 40 years. The Petersons sold the property and moved to Salt Lake City in 1973.
4. Based on the style and construction materials of the house, it is likely the house was built between 1920 and 1930. It is evident that the house was in existence by 1930 as the Federal Census shows the Petersons living at this address at that time.
5. The two-car garage to the west of the historic house was built in its present location by c.1952, based on analysis of historic aerial photographs, the building form and style, and construction materials.
6. The garage is a framed structure consisting of dimensional lumber, consistent with grade standards available after 1949. It was built on a concrete slab foundation. It has framed walls clad in contemporary drop siding that differs from the siding on the historic house. The roof has exposed 2x4 rafter tails beneath the eaves. The original roof decking has been covered with plywood and rolled asphalt siding.
7. In 1979, current owner Dennis Hulbert became part owner of the property, and he gained full ownership in 1991.
8. In 1994, the owner requested a Certificate of Appropriateness for Demolition (CAD) for the historic houses at 1503 Park Avenue and 1503-1/2 Park Avenue, as well as the garage at 1503 Park Avenue. In May 1995, the Historic District Commission (HDC) approved the demolition of the house at 1503-1/2 Park Avenue, but denied the demolition of the house at 1503 Park Avenue.
9. Per the May 15, 1994, HDC minutes, the commission discussed accessory buildings and found, "Because of their condition and their location outside the Historic District, they have little historical significance."

10. On January 14, 1999, the Park City Council approved the two-lot Hulbert-Holler Subdivision; however, the plat was never recorded.
11. In the early 2000s, Park City Municipal Corporation contracted Preservation Solutions, led by Dina Williams-Blaes, to refine and redefine Park City's preservation policy. She completed a reconnaissance level survey in 2007. Her Site Form for 1503 Park Avenue only analyzes the historical significance of the house, not the garage, and found that it contributed to the "Mature Mining Era."
12. On February 4, 2009, the Historic Preservation Board approved a resolution adopting the Historic Sites Inventory. The garage and house at 1503 Park Avenue were designated as "Landmark" and found to be eligible for the National Register of Historic Places (NRHP). She found that the house was constructed c. 1900 and contributed to the Mature Mining Era (1894-1930).
13. In 2015, CRSA completed an intensive level survey and found that the site was "eligible/contributing" to the NRHP. Once again the garage was not individually reviewed and analyzed for its historic integrity and significance.
14. Based on aerial photograph analysis, the garage was built by 1952 making it at least 66 years old. While the site is significant to the Mature Mining Era (1894-1930) because of the c.1930 historic house, the garage individually is not of exceptional importance to the community and was built after the site's era of significance.
15. The garage does not meet the criteria to be designated as Landmark and as outlined by Land Management Code (LMC) 15-11-10(A)(1).
16. While the garage retains its integrity in terms of its location, design, setting, materials, and workmanship, it does not have sufficient integrity to be individually listed on the NRHP or the Park City HSI. The c.1952 garage structure does not evoke the aesthetic or historic sense of the Mature Mining Era (1894-1930). The c.1930 historic house was constructed during this era and reflects architectural styles and detailing that contribute to the look and feel typical of buildings constructed during this era. In the 1950s and 1960s, it was more common for women to have driver's licenses and families could afford two vehicles. This garage responds to the affordability of automobiles and the mobility of families in the postwar era.
17. This garage does not contribute to the Mature Mining Era (1894-1930), nor does it individually contribute to our understanding of the Mining Decline and Emergence of Recreation Industry Era (1931-1962). Original and historic accessory structures can contribute to the historical significance of a site and its surroundings when they have achieved historical significance in their own right. By the 1950s, garages were common and the garage at this site does not contribute to the historical significance of its c.1930 house.
18. While the garage was likely constructed by Victor Peterson, University of Utah alumnus and Park City school teacher, the historic house is a better reflection of his importance in the community. Primary structures dictate the principal use of the property.
19. This garage was constructed of readily available construction materials. Analyzing the garage separate from the historic house, there is nothing

distinctive about its character in terms of the building's type, form, or method of construction that contributes to the Mining Decline and Emergence of Recreation Industry Era (1931-1962). The design is consistent with garage styles that emerged during the postwar period and have continued to be utilized today. The original builder was not a notable architect or master craftsman.

20. The garage does not meet the criteria to be designated as Significant and as outlined by LMC 15-11-10(A)(2).

21. The overall design of the garage has not changed since its construction in c.1952. It is a rectangular building with shallow-pitched front-gable roof. There are two individual wood paneled garage doors on the façade, facing 15th Street.

22. The garage has never received a historic district grant from the City.

23. The site was designated as "Landmark" when the HSI was adopted in 2009; however, the historical significance of the site is due to the c.1930 house. The historical significance is not derived from the c.1952 two-car garage.

24. The garage retains its historic scale, context, and materials. Since its construction in c.1952, minimal changes have occurred to garage apart from maintenance and the construction of a plywood addition on the rear (north) elevation. It is small in scale and mass; it was designed and built to be subordinate to the c.1930 historic house and it has remained so. It is an ordinary detached two-car garage building that neither contributes nor detracts from the architecture of the bungalow-inspired cottage-style house. It does not contribute to the historical significance of the house, which has been determined by the c.1930 house to be the Mature Mining Era (1894-1930).

In order for the garage to contribute to local or regional history, architecture, engineering, or cultural associations, it needs to reflect the period in which it gained this significance. The garage does not reflect the Mature Mining Era (1894-1930). Constructed in 1950, the garage also does not individually contribute to our understanding of the Mining Decline and Emergence of Recreation Industry Era (1931-1962).

25. The garage does not have enough significance in its own right to be listed on the NRHP or the Park City Historic Sites Inventory independently of the house.

26. On March 28, 2018, the owner submitted a Determination of Significance application to remove the historic designation from the garage. The application was deemed complete on April 5, 2018.

### Conclusions of Law – 1503 Park Avenue

1. The existing house located at 1503 Park Avenue does not meet all of the criteria for designating sites to the Park City Historic Sites Inventory as a Landmark Site including:

a. It is at least fifty (50) years old or has achieved Significance or if the Site is of exceptional importance to the community; and Complies;

b. It retains its Historic Integrity in terms of location, design, setting, materials, workmanship, feeling and association as defined by the National Park Service for the National Register of Historic Places; and Does Not

Comply.

c. It is significant in local, regional or national history, architecture, engineering or culture associated with at least one (1) of the following:

- i. An era that has made a significant contribution to the broad patterns of our history;
- ii. The lives of Persons significant in the history of the community, state, region, or nation; or
- iii. The distinctive characteristics of type, period, or method of construction or the work of a notable architect or master craftsman. Does not comply.

2. The existing house at 819 Park Avenue does not meet all of the criteria for a Significant Site as set forth in LMC Section 15-11-10(A)(2) which includes:

(a) It is at least fifty (50) years old or the Site is of exceptional importance to the community; and Complies.

(b) It retains its Historical Form as may be demonstrated but not limited by any of the following:

- (i) It previously received a historic grant from the City; or
- (ii) It was previously listed on the Historic Sites Inventory; or
- (iii) It was listed as Significant or on any reconnaissance or intensive level survey of historic resources; and Complies.

(c) It has one (1) or more of the following:

- (i) It retains its historic scale, context, materials in a manner and degree which can be restored to Historical Form even if it has non-historic additions; or
- (ii) It reflects the Historical or Architectural character of the site or district through design characteristics such as mass, scale, composition, materials, treatment, cornice, and/or other architectural features as are Visually Compatible to the Mining Era Residences National Register District even if it has non-historic additions; and Complies.

(d) It is important in local or regional history architecture, engineering, or culture associated with at least one (1) of the following:

- (i) An era of Historic Importance to the community, or
- (ii) Lives of Persons who were of Historic importance to the community, or
- (iii) Noteworthy methods of construction, materials, or craftsmanship used during the Historic period. Does not comply.

The Meeting adjourned at 6:12 p.m.

## Planning Commission Staff Report

**Subject:** 813 Woodside Avenue Plat Amendment  
**Author:** Liz Jackson, Planning Technician  
Francisco Astorga, AICP, Senior Planner  
**Project Number:** PL-18-03841  
**Date:** 13 June 2018  
**Type of Item:** Legislative – Plat Amendment

### Summary Recommendations

Staff recommends the Planning Commission review and hold a public hearing for the 813 Woodside Avenue Plat Amendment and consider forwarding a positive recommendation to the City Council based on the Findings of Fact, Conclusions of Law, and Conditions of Approval as found in the draft ordinance.

### Description

**Applicant:** Ian R. and D. Lance Kincaid, represented by Marshall King, Alliance Engineering, Inc.  
**Location:** 813 Woodside Avenue  
**Zoning:** Historic Residential-1 District  
**Adjacent Land Uses:** Residential  
**Reason for Review:** Plat Amendments require Planning Commission review and City Council review and action

### Proposal

Plat Amendment request to remove a lot line to combine one and half (1½) Old Town lots into one (1) lot of record. The entire area is already identified by Summit County as Parcel SA-122.

### Background

On April 13, 2018 Kincaid applied for a Plat Amendment to combine their property into one (1) lot by removing an interior lot line. The application was deemed complete on May 5, 2018, as required submittals were received by the City on May 3, 2018. The applicant currently has a Historic District Design Review application under review. This Plat Amendment is the first step in moving forward with their future improvements to this non-historic site. The subject site consists of the northern half of Lot 2 and all of Lot 3, Block 11, within the Snyder's Addition to the Park City Survey.

### Purpose

The purpose of the Historic Residential-1 District is to:

- A. preserve present land Uses and character of the Historic residential Areas of Park City,
- B. encourage the preservation of Historic Structures,

- C. encourage construction of Historically Compatible Structures that contribute to the character and scale of the Historic District and maintain existing residential neighborhoods,
- D. encourage single family Development on combinations of 25' x 75' Historic Lots,
- E. define Development parameters that are consistent with the General Plan policies for the Historic core, and
- F. establish Development review criteria for new Development on Steep Slopes which mitigate impacts to mass and scale and the environment.

**Analysis**

The subject site is located at 813 Woodside Avenue. The site is within the Historic Residential-1 District. The proposed Plat Amendment creates one (1) lot from one and a half (1½) Old Town lots. The applicant requests to eliminate the lot line going through the non-historic structure. The minimum lot size within the Historic Residential-1 District is 1,875 square feet. The proposed lot size is 2,417 square feet. The minimum lot width within the Historic Residential-1 District is twenty five feet (25'). The proposed lot width is thirty-seven and half feet (37.5'). The proposed lot combination, Plat Amendment, meets lot and site requirements of the Historic Residential-1 District. The following table contains development parameters of the Historic Residential-1 District:

Parameter	Permitted
Maximum Building Height	27 feet
Minimum Front / Rear Yard Setbacks	10 feet
Minimum Side Yard Setbacks	3 feet
Maximum Building Footprint	1,055 square feet

**Encroachments**

There is a railroad tie retaining wall on this site that encroaches onto the Woodside Avenue public Right-of-Way. See photograph below and illustration from Exhibit C – Existing Conditions Survey, zoomed in, next page:



813 Woodside Avenue - looking westerly



Diagram from Exhibit C – Existing Conditions Survey, zoomed in

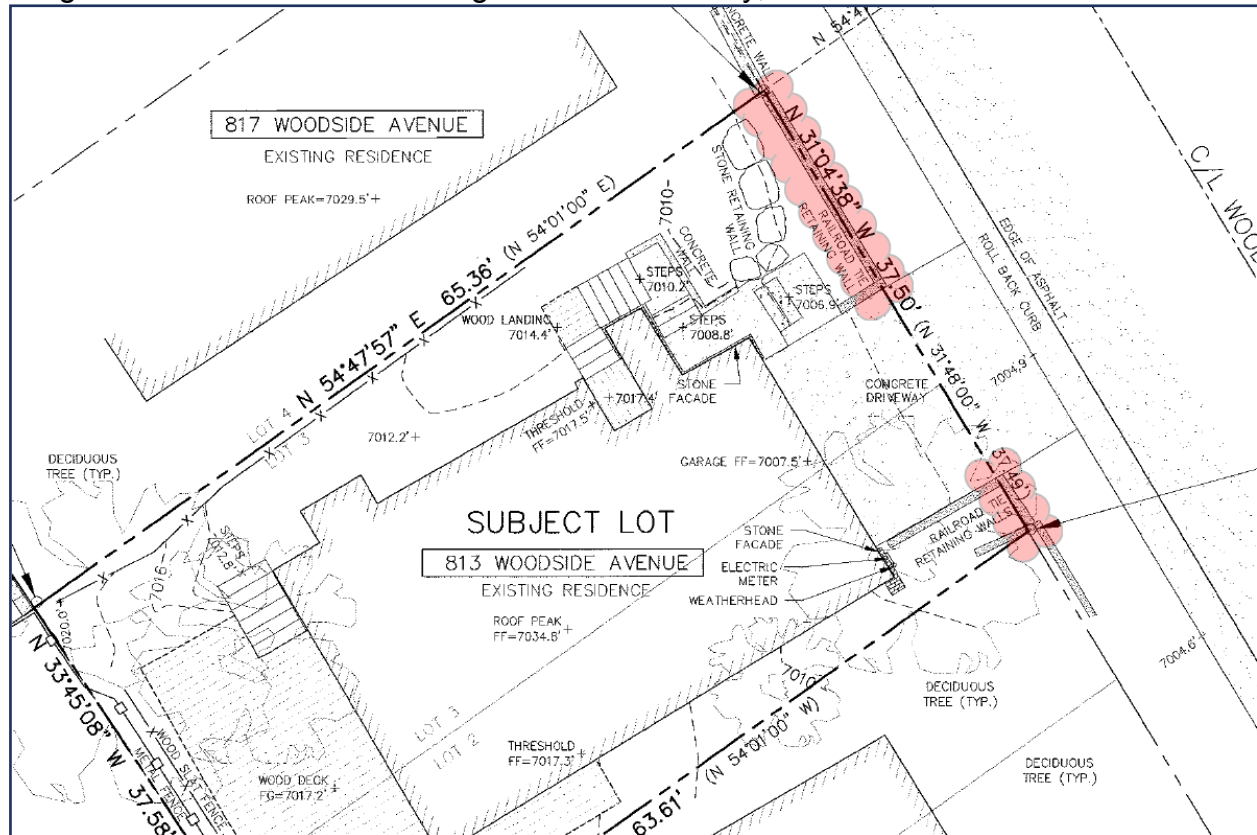

This retaining wall is approximately sixteen inches (16”) high and straddles the front property / Right-of-Way line, except the existing concrete driveway. Staff recommends that before the Plat is recorded, the applicant will need to remove the existing railroad tie retaining wall encroaching onto the Right-of-Way so that the retaining wall is completely within private property. This retaining wall is not historic and the applicant is able to apply for a Historic District Design Review application to resolve the Right-of-Way encroachment. See Condition of Approval no. 3.

**Good Cause**

Staff finds that there is good cause for this Plat Amendment as the interior lot line running through the existing structure will be removed, creating one (1) lot of record, instead of having one and half (1½) Old Town lots. As a common practice, a public snow storage easement will be provided on the site to be reflected on the proposed plat. This Plat Amendment does not create a remnant parcel as the other half of Lot 2 was already re-platted in 2002 as part of the 805 Woodside Avenue Plat Amendment. Existing encroachments will also be resolved prior to plat recordation.

**Process**

The approval of this Plat Amendment application by the City Council constitutes Final Action that may be appealed following the procedures found in LMC §15-1-18.

### **Department Review**

This project has gone through an interdepartmental review. No further issues were brought up at that time.

### **Notice**

On May 30, 2018, the property was posted and notice was mailed to property owners within 300 feet. Legal notice was also published in the Park Record and the Utah Public Notice Website on May 26, 2018, according to requirements of the LMC.

### **Public Input**

No public input has been received by the time of this report.

### **Alternatives**

- The Planning Commission may forward a positive recommendation to the City Council for the 813 Woodside Avenue Plat Amendment, as conditioned or amended; or
- The Planning Commission may forward a negative recommendation to the City Council for the 813 Woodside Avenue Plat Amendment, and direct staff to make Findings for this decision; or
- The Planning Commission may continue the discussion on the 813 Woodside Avenue Plat Amendment, and request additional information or analysis in order to make a recommendation.

### **Significant Impacts**

There are no significant fiscal or environmental impacts from this application.

### **Consequences of not taking recommended action**

Consequences of not taking the recommended action is that the site would continue to be one and a half (1½) lots containing a lot line going through the structure with various front property line unaddressed encroachments on the public Right-of-Way.

### **Summary Recommendation**

Staff recommends the Planning Commission review and hold a public hearing for the 813 Woodside Avenue Plat Amendment and consider forwarding a positive recommendation to the City Council based on the Findings of Fact, Conclusions of Law, and Conditions of Approval as found in the draft ordinance.

### **Exhibits**

Exhibit A – Draft Ordinance with Proposed Plat (Attachment 1)

Exhibit B – Applicant's Project Intent

Exhibit C – Existing Conditions Survey

Exhibit D – Aerial Photograph

Exhibit E – County Plat Map

Exhibit F – Site Photographs

**Ordinance No. 18-XX**

**AN ORDINANCE APPROVING THE 813 WOODSIDE AVENUE PLAT AMENDMENT  
LOCATED AT 813 WOODSIDE AVENUE, PARK CITY, UTAH.**

WHEREAS, the property owners of the property located at 813 Woodside Avenue have petitioned the City Council for approval of the Plat Amendment; and

WHEREAS, on May 30, 2018, the property was properly noticed and posted according to the requirements of the Land Management Code; and

WHEREAS, on May 26, 2018, proper legal notice was published according to requirements of the Land Management Code and courtesy letters were sent to surrounding property owners; and

WHEREAS, the Planning Commission held a public hearing on June 13, 2018, to receive input on plat amendment; and

WHEREAS, the Planning Commission, on June 13, 2018, forwarded a recommendation to the City Council; and,

WHEREAS, on July 12, 2018, the City Council held a public hearing to receive input on the plat amendment; and

WHEREAS, it is in the best interest of Park City, Utah to approve the 813 Woodside Avenue Plat Amendment, located at the same address.

NOW, THEREFORE BE IT ORDAINED by the City Council of Park City, Utah as follows:

**SECTION 1. APPROVAL.** The 813 Woodside Avenue Plat Amendment as shown in Attachment 1 is approved subject to the following Findings of Facts, Conclusions of Law, and Conditions of Approval:

**Findings of Fact:**

1. The site is located at 813 Woodside Avenue.
2. The site is within the Historic Residential-1 District.
3. The subject site consists of the northern half of Lot 2 and all of Lot 3, Block 11, within the Snyder's Addition to the Park City Survey.
4. The proposed Plat Amendment creates one (1) lot from one and a half (1½) Old Town lots.
5. The applicant requests to eliminate the lot line going through the non-historic structure.

6. The minimum lot size within the Historic Residential-1 District is 1,875 square feet.
7. The proposed lot size is 2,417 square feet.
8. The minimum lot width within the Historic Residential-1 District is twenty five feet (25').
9. The proposed lot width is thirty-seven and half feet (37.5').
10. The proposed lot combination, Plat Amendment, meets lot and site requirements of the Historic Residential-1 District.
11. There is a railroad tie retaining wall on this site that encroaches onto the Woodside Avenue public Right-of-Way.
12. The railroad tie retaining wall is not historic and the applicant is able to apply for a Historic District Design Review application to remove or move the retaining wall. See Condition of Approval no. 3.
13. All findings within the Analysis section and the recitals above are incorporated herein as findings of fact.

**Conclusions of Law:**

1. There is good cause for this Plat Amendment.
2. The Plat Amendment is consistent with the Park City Land Management Code and applicable State law regarding lot combinations.
3. Neither the public nor any person will be materially injured by the proposed Plat Amendment.
4. Approval of the Plat Amendment, subject to the conditions stated below, does not adversely affect the health, safety and welfare of the citizens of Park City.

**Conditions of Approval:**

1. The City Planner, City Attorney, and City Engineer will review and approve the final form and content of the plat for compliance with State law, the Land Management Code, and the conditions of approval, prior to recordation of the plat.
2. The applicant shall record the plat at the County within one year from the date of City Council approval. If recordation has not occurred within one (1) years' time, this approval for the plat will be void, unless a request for an extension is made in writing prior to the expiration date and an extension is granted by the City Council.
3. Prior to plat recordation, the applicant shall remove the existing railroad tie retaining wall encroachment from the City Right-of-Way. The applicant is responsible of securing appropriate City approvals and permits before any work on the retaining wall can begin.
4. Residential fire sprinklers are required for all new construction per requirements of the Chief Building Official, and shall be noted on the plat.
5. Ten foot (10') public snow storage easement shall be granted along the Woodside Avenue Right-of-Way.

**SECTION 2. EFFECTIVE DATE.** This Ordinance shall take effect upon publication.

PASSED AND ADOPTED this 12<sup>th</sup> day of July, 2018.

PARK CITY MUNICIPAL CORPORATION

\_\_\_\_\_  
Andy Beerman, MAYOR

ATTEST:

\_\_\_\_\_  
Michelle Kellogg, City Recorder

APPROVED AS TO FORM:

\_\_\_\_\_  
Mark Harrington, City Attorney

# Attachment 1 – Proposed Plat

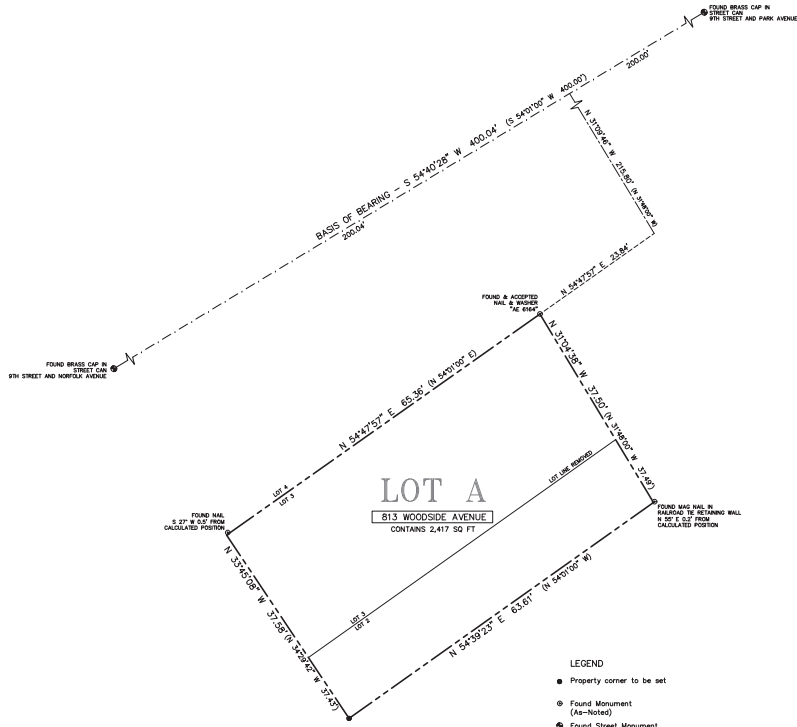

- NOTES**
- This plat amendment is subject to the Conditions of Approval in Ordinance 2018-\_\_\_\_\_.
  - Record bearings and distances, when different from measured, are shown in parenthesis ( ).
  - See Record of Survey S-9327.

## 813 WOODSIDE AVENUE PLAT AMENDMENT

LOCATED IN THE NORTHEAST QUARTER OF SECTION 16  
TOWNSHIP 2 SOUTH, RANGE 4 EAST, SALT LAKE BASE AND MERIDIAN  
PARK CITY, SUMMIT COUNTY, UTAH



### SURVEYOR'S CERTIFICATE

I, Charles Galati, do hereby certify that I am a Professional Land Surveyor and that I hold License No. 7248891, as prescribed by the laws of the State of Utah, and that by authority of the owner, 813 WOODSIDE AVENUE PLAT AMENDMENT has been reviewed under my direction, and that the same has been or will be monumented on the ground as shown on this plat. I further certify that the information on this plat is accurate.

### LEGAL DESCRIPTION

The North 1/2 of Lot 2 and All of Lot 3, Block 11, SNYDER'S ADDITION TO PARK CITY, according to the plat thereof as recorded in the office of the Summit County Recorder, records of Summit County, Utah.

### OWNER'S DEDICATION AND CONSENT TO RECORD

KNOW ALL MEN BY THESE PRESENTS that Ian R. Kincaid and D. Lance Kincaid, Successor Co-Trustees of the KINCAID REVOCABLE TRUST dated May 2, 1977, as to an undivided 48% interest, hereby certify that they have caused this plat amendment to be made and hereby consent to the recordation of this Plat Amendment.

ALSO, the owner hereby irrevocably offers for dedication to the City of Park City all the easements shown on this plat in accordance with an irrevocable offer of dedication.

In witness whereof, the undersigned set his hand this \_\_\_\_\_ day of \_\_\_\_\_, 2018.

In witness whereof, the undersigned set his hand this \_\_\_\_\_ day of \_\_\_\_\_, 2018.

By: Ian R. Kincaid, Successor Co-Trustee  
By: D. Lance Kincaid, Successor Co-Trustee

### ACKNOWLEDGMENT

State of \_\_\_\_\_ )  
County of \_\_\_\_\_ ) ss.

On this \_\_\_\_\_ day of \_\_\_\_\_, 2018, Ian R. Kincaid personally appeared before me, whose identity is personally known to me or proven on the basis of satisfactory evidence, and who by me duly sworn/affirmed, did say that he is a Successor Co-Trustee of the Kincaid Revocable Trust dated May 2, 1977, and that said document was signed by him on behalf of said Trust by authority of the Trust, and he acknowledged to me that he executed the 813 WOODSIDE AVENUE PLAT AMENDMENT.

A Notary Public commissioned in \_\_\_\_\_

Printed Name \_\_\_\_\_ Residing In: \_\_\_\_\_  
My commission expires: \_\_\_\_\_ Commission No: \_\_\_\_\_

### ACKNOWLEDGMENT

State of \_\_\_\_\_ )  
County of \_\_\_\_\_ ) ss.

On this \_\_\_\_\_ day of \_\_\_\_\_, 2018, D. Lance Kincaid personally appeared before me, whose identity is personally known to me or proven on the basis of satisfactory evidence, and who by me duly sworn/affirmed, did say that he is a Successor Co-Trustee of the Kincaid Revocable Trust dated May 2, 1977, and that said document was signed by him on behalf of said Trust by authority of the Trust, and he acknowledged to me that he executed the 813 WOODSIDE AVENUE PLAT AMENDMENT.

A Notary Public commissioned in \_\_\_\_\_

Printed Name \_\_\_\_\_ Residing In: \_\_\_\_\_  
My commission expires: \_\_\_\_\_ Commission No: \_\_\_\_\_

### OWNER'S DEDICATION AND CONSENT TO RECORD

KNOW ALL MEN BY THESE PRESENTS that Ian R. Kincaid, as to an undivided 38.5% interest, hereby certifies that he has caused this plat amendment to be made and hereby consents to the recordation of this Plat Amendment.

ALSO, the owner hereby irrevocably offers for dedication to the City of Park City all the easements shown on this plat in accordance with an irrevocable offer of dedication.

In witness whereof, the undersigned set his hand this \_\_\_\_\_ day of \_\_\_\_\_, 2018.

By: Ian R. Kincaid

### ACKNOWLEDGMENT

State of \_\_\_\_\_ )  
County of \_\_\_\_\_ ) ss.

On this \_\_\_\_\_ day of \_\_\_\_\_, 2018, Ian R. Kincaid personally appeared before me, whose identity is personally known to me or proven on the basis of satisfactory evidence, and who by me duly sworn/affirmed, did say that he is a Successor Co-Trustee of the Kincaid Revocable Trust dated May 2, 1977, and that said document was signed by him on behalf of said Trust by authority of the Trust, and he acknowledged to me that he executed the 813 WOODSIDE AVENUE PLAT AMENDMENT.

A Notary Public commissioned in \_\_\_\_\_

Printed Name \_\_\_\_\_ Residing In: \_\_\_\_\_  
My commission expires: \_\_\_\_\_ Commission No: \_\_\_\_\_

### OWNER'S DEDICATION AND CONSENT TO RECORD

KNOW ALL MEN BY THESE PRESENTS that D. Lance Kincaid, as to an undivided 13.5% interest, hereby certifies that he has caused this plat amendment to be made and hereby consents to the recordation of this Plat Amendment.

ALSO, the owner hereby irrevocably offers for dedication to the City of Park City all the easements shown on this plat in accordance with an irrevocable offer of dedication.

In witness whereof, the undersigned set his hand this \_\_\_\_\_ day of \_\_\_\_\_, 2018.

By: D. Lance Kincaid

### ACKNOWLEDGMENT

State of \_\_\_\_\_ )  
County of \_\_\_\_\_ ) ss.

On this \_\_\_\_\_ day of \_\_\_\_\_, 2018, D. Lance Kincaid personally appeared before me, whose identity is personally known to me or proven on the basis of satisfactory evidence, and who by me duly sworn/affirmed, did say that he is a Successor Co-Trustee of the Kincaid Revocable Trust dated May 2, 1977, and that said document was signed by him on behalf of said Trust by authority of the Trust, and he acknowledged to me that he executed the 813 WOODSIDE AVENUE PLAT AMENDMENT.

A Notary Public commissioned in \_\_\_\_\_

Printed Name \_\_\_\_\_ Residing In: \_\_\_\_\_  
My commission expires: \_\_\_\_\_ Commission No: \_\_\_\_\_



 (435) 648-9487 CONSULTING ENGINEERS LAND PLANNERS SURVEYORS 323 Main Street, P.O. Box 2664 Park City, Utah 84060-2664	SNYDERVILLE BASIN WATER RECLAMATION DISTRICT REVIEWED FOR CONFORMANCE TO SNYDERVILLE BASIN WATER RECLAMATION DISTRICT STANDARDS ON THIS _____ DAY OF _____, 2018 BY _____ S.B.W.R.D.	PLANNING COMMISSION APPROVED BY THE PARK CITY PLANNING COMMISSION THIS _____ DAY OF _____, 2018 BY _____ CHAIR	ENGINEER'S CERTIFICATE I FIND THIS PLAT TO BE IN ACCORDANCE WITH INFORMATION ON FILE IN MY OFFICE THIS _____ DAY OF _____, 2018 BY _____ PARK CITY ENGINEER	APPROVAL AS TO FORM APPROVED AS TO FORM THIS _____ DAY OF _____, 2018 BY _____ PARK CITY ATTORNEY	COUNCIL APPROVAL AND ACCEPTANCE APPROVAL AND ACCEPTANCE BY THE PARK CITY COUNCIL THIS _____ DAY OF _____, 2018 BY _____ MAYOR	CERTIFICATE OF ATTEST CERTIFY THIS PLAT MAP WAS APPROVED BY PARK CITY COUNCIL THIS _____ DAY OF _____, 2018 BY _____ PARK CITY RECORDER	RECORDED STATE OF UTAH, COUNTY OF SUMMIT, AND FILED AT THE REQUEST OF _____ FEE _____ RECORDER TIME _____ DATE _____ ENTRY NO. _____
	JOB NO.: 6-1-18 FILE: X:\SnydersAddition\dwg\lrv\plat2018\060118.dwg						

BLOCK 11,  
SNYDER'S ADDITION TO PARK CITY SURVEY  
Lot 3 and a portion of Lot 2

(813 Woodside Avenue)

PROJECT INTENT

Lot 3 and a portion of Lot 2, Snyder's Addition to Park City Survey, (also known as 813 Woodside Avenue) are owned by undivided interest between the Kincaid Revocable Trust, Ian R. Kincaid, and D. Lance Kincaid. The lot line within the boundary still exists from the original Snyder's Addition to Park City Survey plat. The owners desire to unify the property into one lot of record by removing the existing lot line, with the ultimate goal of renovating the existing single family residence. At this point in time plans have not been finalized, but it is anticipated that the existing two-car garage will be converted to a one-car garage and separate



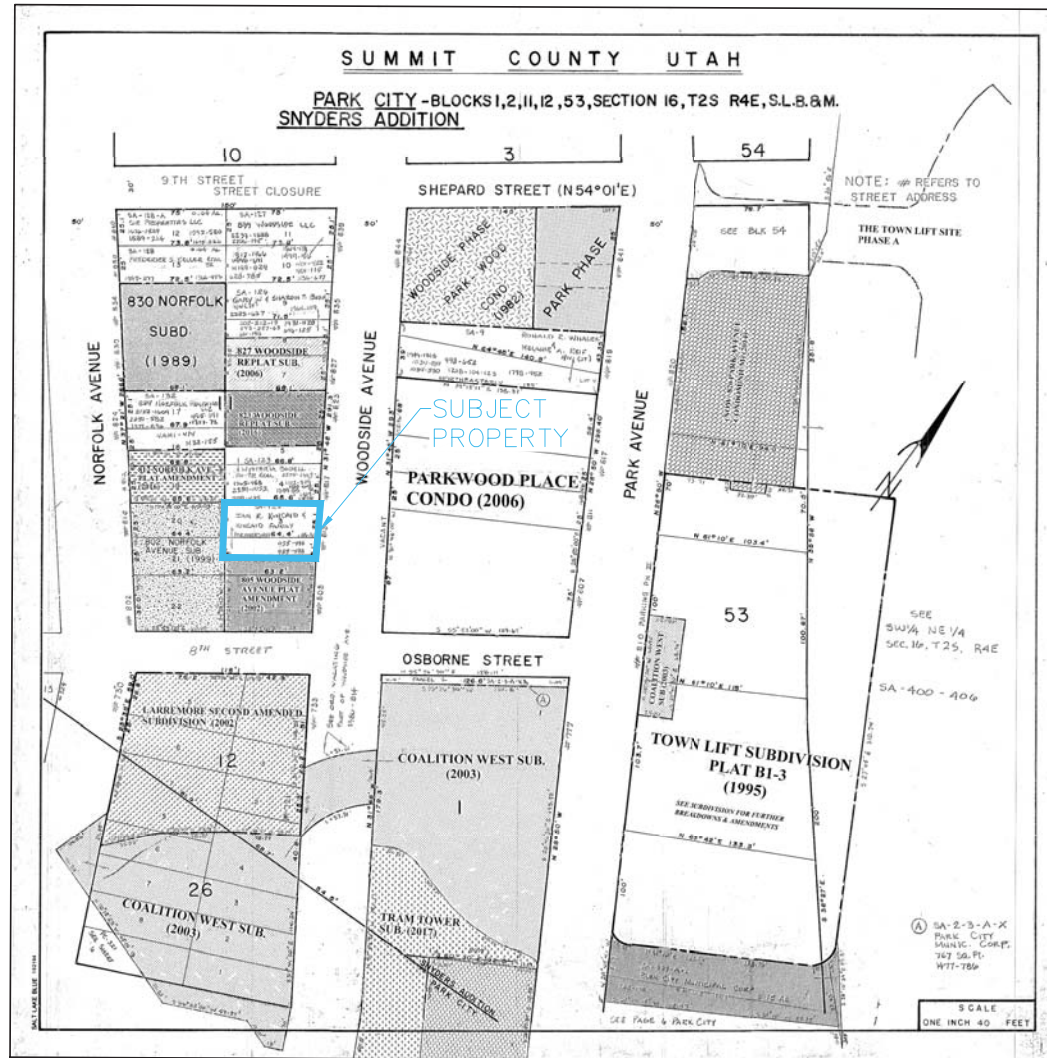

Exhibit D – Aerial Photograph



 <small>CONSULTING ENGINEERS LAND PLANNERS SURVEYORS 322 Main Street, P.O. Box 2654, Provo, Utah 84602-2654</small>	<small>(435) 648-2467</small>	<small>STAFF: RYAN BEITZ MARSHALL KING</small>	<b>AERIAL PHOTOGRAPH</b> <b>813 WOODSIDE AVENUE</b> <b>BLOCK 11, SNYDER'S ADDITION</b>	<b>SHEET</b> <b>1</b> <b>OF</b> <b>1</b>
	<small>DATE: 3/27/18</small>	<small>FOR: LANCE KINCAID JOB NO.: 6-1-18 FILE: X:\SnydersAddition\dwg\Exhibits\813 Woodside-ortho.dwg</small>		





 <p>(435) 648-2467</p> <p>CONSULTING ENGINEERS LAND PLANNERS SURVEYORS 323 Main Street, P.O. Box 2044, Park City, Utah 84060-2044</p>	<p>STAFF: RYAN BEITZ MARSHALL KING</p>	<p>OWNERSHIP MAP 813 WOODSIDE AVENUE BLOCK 11, SNYDER'S ADDITION</p>	<p>SHEET 1 OF 1</p>
	<p>DATE: 3/27/18</p>	<p>FOR: LANCE KINCAID JOB NO.: 6-1-18 FILE: X:\SnydersAddition.dwg\Exhibit\813 Woodside-ownership.dwg</p>	



Exhibit F – Site Photographs



813 Woodside Avenue - looking southerly



Exhibit F – Site Photographs



813 Woodside Avenue - looking westerly



Exhibit F – Site Photographs



813 Woodside Avenue - looking easterly





813 Woodside Avenue - looking to the north





813 Woodside Avenue - looking southeasterly



PLANNING DEPARTMENT

# Planning Commission Staff Report

**Subject:** Setback and Yard Definitions  
**Author:** Tippe Morlan, AICP, Planner II  
 Liz Jackson, Planning Technician  
 Laura Newberry, Planning Technician  
**Date:** June 13, 2018  
**Type of Item:** Legislative – LMC Amendment

<b>Project Number:</b>	PL-18-03867
<b>Applicant:</b>	Park City Planning Department
<b>Affected LMC Chapters:</b>	15-2 Zoning Districts 15-3 Off-Street Parking 15-4 Supplemental Regulations 15-15 Defined Terms
<b>Reason for Review:</b>	LMC Amendments require Planning Commission review, and City Council review and action.

### Proposal

The applicant is requesting an amendment to the existing Land Management Code (LMC) relating to Setbacks and Yards. The proposed amendment affects the following LMC Chapters 15-2 Zoning Districts, 15-3 Off-Street Parking, 15-4 Supplemental Regulations, and 15-5 Defined Terms as described in this report.

### Recommendation

Staff recommends that the Planning Commission review and conduct a public hearing for the LMC amendments relating to Setbacks and Yards and consider forwarding a **positive** recommendation to the City Council based on the Findings of Fact, Conclusions of Law, and Conditions of Approval as found in the draft ordinance.

### Background

The terms Setback and Yard (Front, Rear, and Side) are used inconsistently within the LMC. They have been used interchangeably in multiple sections, causing confusion among members of the public and difficulty interpreting the LMC by the Planning Department staff and applicants. Staff has reviewed the existing usage of these terms in the LMC and requests to amend the following:

1. Setback and Yard Definitions
2. Replacing the term Yard with Setback when it is used to reflect Setback requirements
3. Replacing unclear and unreadable Setback and Yard images

These amendments are proposed to provide clarity and consistency in the LMC.



### **Analysis 1 –Setback and Yard Definitions**

Staff finds that the existing definitions for Setbacks and Yards found in LMC Section 15-15-1 can be clarified to provide greater direction and precision for all users of the LMC. The concept of a Setback versus a Yard can be difficult to differentiate since they are so similar. The proposed amendment clarifies the difference between Setback and Yard consistent with how the terms have been interpreted by the Planning Department. These definitions are a result of extensive research of development codes and zoning codes from comparable resort communities.

The main difference between a Setback and a Yard is that a Setback is defined by the parameters of a Lot specific to the Zone, and a Yard is defined by the location of the Main Structure on a Lot. There does not need to be any Structure on a Lot for it to have Setback standards, although Yards do not exist until a Structure is located on a Lot.

Where the terms may become confused is when a distance between the Property Line and a Structure on a Lot is also referred to as a Setback. This distance may be more than the required minimum Setback distance. When the LMC identifies Setbacks, it is to regulate the area within the *minimum* required Setback. The LMC does not define or regulate a full “Setback” distance between a Property Line and a Structure – just the minimum Setback distance necessary as determined based on the Zoning District.

Additionally, the term Yard often gets used in reference to Setbacks because Setbacks are located within the Yard area of any property. However, a Yard includes the Setback area in addition to all other property between a Property Line and a Structure. A Yard is simply the area between a Property Line and the Structure regardless of what that distance is.

The proposed definitions below aim to clarify these differences. A majority of the redlines in Exhibit A – Attachment 1 updates the term Yard to Setback in places where the code refers to the minimum Setback requirements for a Lot as opposed to a Yard defined by a Structure on a lot. The redlines also show the change in definitions in LMC Section 15-15-1.

<b>Current Definition of Setback</b>	<b>Proposed Definition of Setback</b>
The required minimum distance between a Building Pad and the closest of the following: Property Line; platted Street; or existing curb or edge of a Street.	The area of a Lot that must remain open and cannot be built over with a Structure. This is the minimum horizontal distance between a specified lot line (front, side, rear), measured along a straight line and at a right angle to such lot line, and the nearest point of an above grade or below grade building or structure.

Current Definition of Yard	Proposed Definition of Yard
<ol style="list-style-type: none"> <li>1. Yard, Front. The Area between the front of the closest Building and the Front Lot Line or closer Right-of-Way, extending the full width of the Lot. The “depth” of the Front Yard is the minimum distance between the Front Lot Line and the front line of the closest Structure.</li> <li>2. Yard, Rear. The Area between the rear line of the closest Building and the Rear Lot Line, or closer Right-of-Way, and extending the full width of the Lot. The “depth” of the Rear Yard is the minimum distance between the Rear Lot Line and the rear line of the closest Structure.</li> <li>3. Yard, Side. The Area between the side line of the Building and the Side Lot Line and extending from the Front Yard to the Rear Yard. The “width” of the Side Yard shall be the minimum distance between the Side Lot Line and the side line of the closest Structure. See the following illustration:</li> </ol>	<p>YARD. The portion of a Lot between any Property Line and the nearest point of the Main Building.</p> <ol style="list-style-type: none"> <li>1. Yard, Front. A yard extending across the full width of the Lot between the Front Lot Line and the nearest line or point of the Building. The Area between the front of the closest Building and the Front Lot Line or closer Right-of-Way, extending the full width of the Lot. The “depth” of the Front Yard is the minimum distance between the Front Lot Line and the front line of the closest Structure.</li> <li>2. Yard, Rear. A yard extending across the full width of the Lot between the Rear Lot Line and the nearest line or point of the Building. The Area between the rear line of the closest Building and the Rear Lot Line, or closer Right-of-Way, and extending the full width of the Lot. The “depth” of the Rear Yard is the minimum distance between the Rear Lot Line and the rear line of the closest Structure.</li> <li>3. Yard, Side. A yard extending from the Front Yard to the Rear Yard between the Side Lot Line and the nearest line or point of the Building. The Area between the side line of the Building and the Side Lot Line and extending from the Front Yard to the Rear Yard. The “width” of the Side Yard shall be the minimum distance between the Side Lot Line and the side line of the closest Structure.</li> </ol>

**Analysis 2 – Replacing the term Yard with Setback**

In accordance with the conflation of the terms Setback and Yard as described above, Staff finds that the term “Yard” is used in reference to Setback regulations throughout the LMC. In order to provide clarity, the proposed amendment replaces the term “Yard” with the term “Setback” in all applicable instances. This occurs in twenty-three (23) separate Sections of the LMC and affects the following twenty (20) Zoning Districts:

- 15-2.1 Historic Residential-Low Density (HRL)
- 15-2.2 Historic Residential (HR-1)
- 15-2.3 Historic Residential (HR-2)
- 15-2.4 Historic Residential Medium District (HRM)
- 15-2.5 Historic Recreation Commercial (HRC)
- 15-2.6 Historic Commercial Business (HCB)

- 15-2.7 Recreation and Open Space (ROS)
- 15-2.8 Protected Open Space (POS)
- 15-2.9 Rural Estate (E-40)
- 15-2.10 Estate (E)
- 15-2.11 Single Family (SF)
- 15-2.12 Residential (R-1)
- 15-2.13 Residential Development (RD)
- 15-2.14 Residential Development-Medium Density (RDM)
- 15-2.15 Residential- Medium Density (RM)
- 15-2.16 Recreation Commercial (RC)
- 15-2.18 General Commercial (GC)
- 15-2.19 Light Industrial (LI)
- 15-2.22 Public Use Transition (PUT)
- 15-2.23 Community Transition (CT)
- 15-3 Off-Street Parking
- 15-4 Supplemental Regulations
- 15-15 Defined Terms

The proposed redlines for these Sections of the LMC replace the term “Yard” with the term “Setback” when it is used in reference to a Setback regulation (see the complete set of Redlines in the attached Exhibit A – Attachment 1).

**Analysis 3 – Replacing Setback and Yard Images**

In the LMC, Staff has found several images which refer to Setbacks and Yards that contain the incorrect term and/or are difficult to read due to image quality. The proposed images below clarify these issues.

Existing Image 1 – This image appears in the Rear Setback Exceptions throughout Chapter 2 of the LMC. This is one example where the term Yard was used in place of Setback. Additionally, the image is blurry and difficult to read.

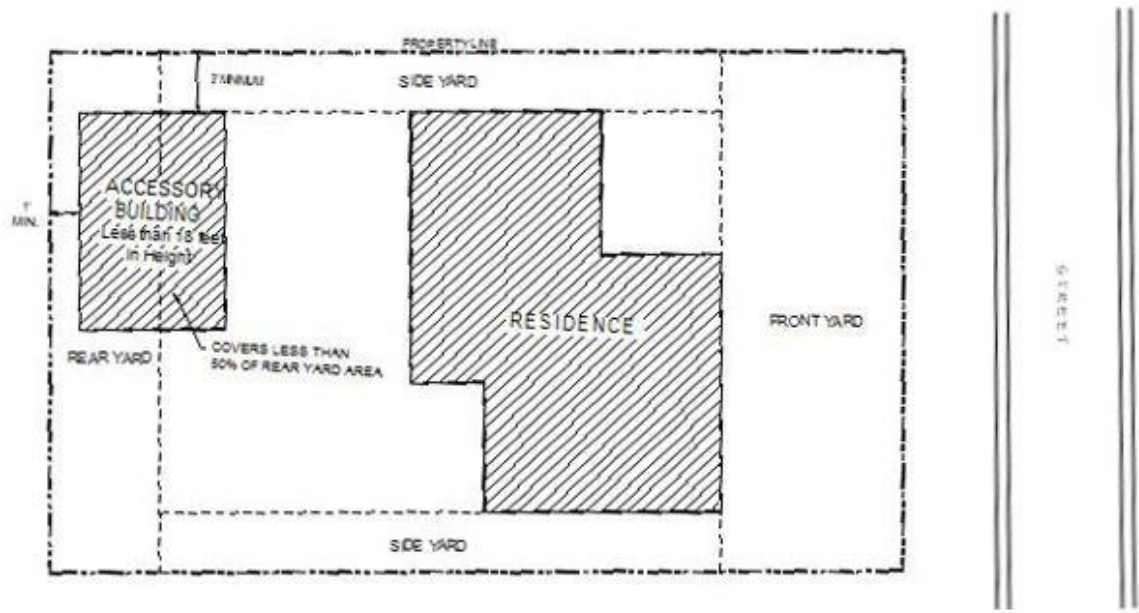

Proposed Image 1 – This image will be used to replace the above Existing Image 1 in all instances to provide a clearer, easier to read image. The main change in this image is to change the term Yard to Setback since Yards encompass the entire area from the Property Line to a Main Structure while Setbacks are the minimum regulated areas measured from the Property Line inward.

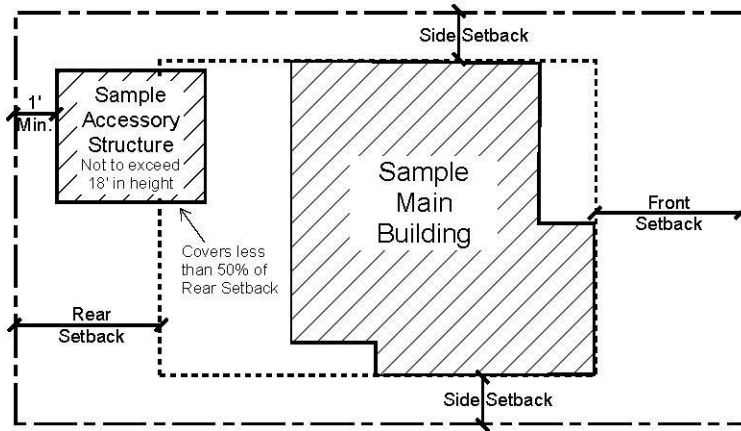

Existing Image 2 – This image appears in Chapter 15 of the LMC in both the definition of Building Pad and in the definition of Yard. It is extremely blurry and illegible.

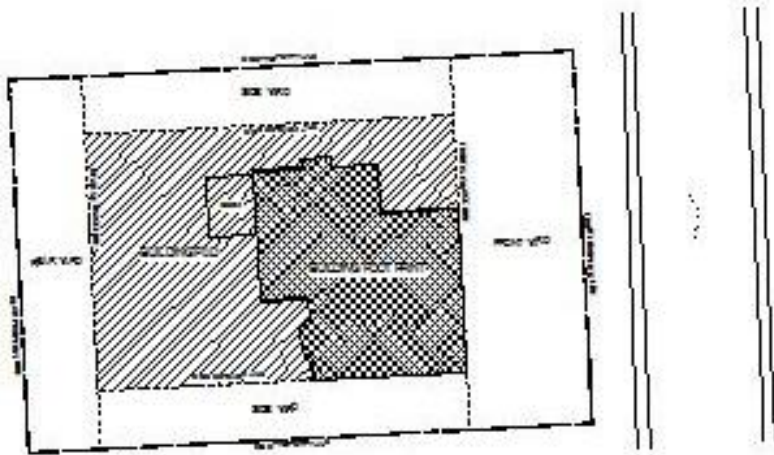



Proposed Image 2 – This image will only be used to replace the above Existing Image 2 in the Definition of Building Pad and comes from existing Building Footprint requirements in Chapter 2 of the LMC. It is much easier to read and shows the Building Pad in a clearer manner.

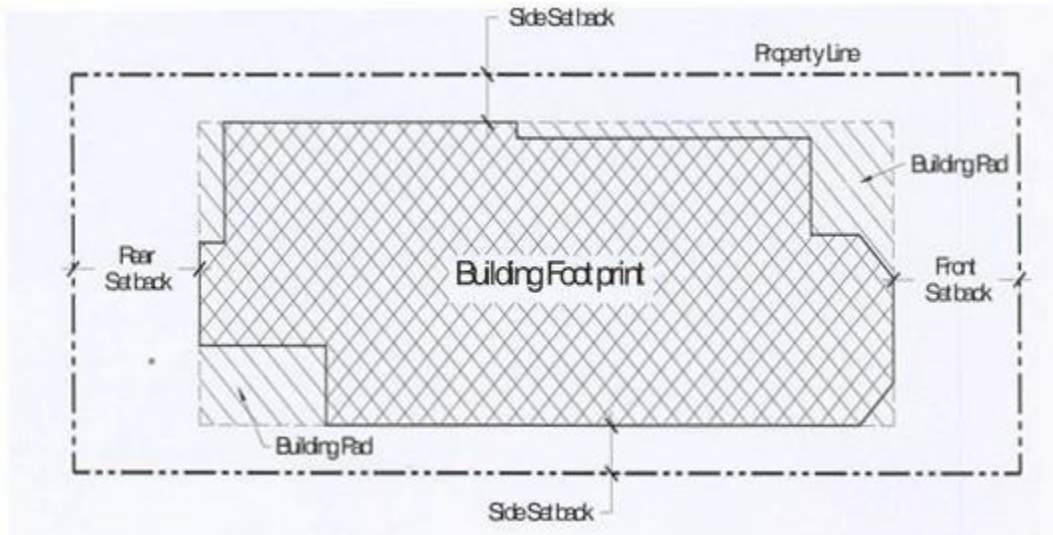

Proposed Image 3 – This image will only be used to replace the above Existing Image 2 in the Definition of Yard. This updates the image to reflect the proposed definitions of Yard above by showing the entire Yard area from the Property Line to the Main Structure as opposed to the area from the Property Line to the minimum regulated Setback area which was previously shown.

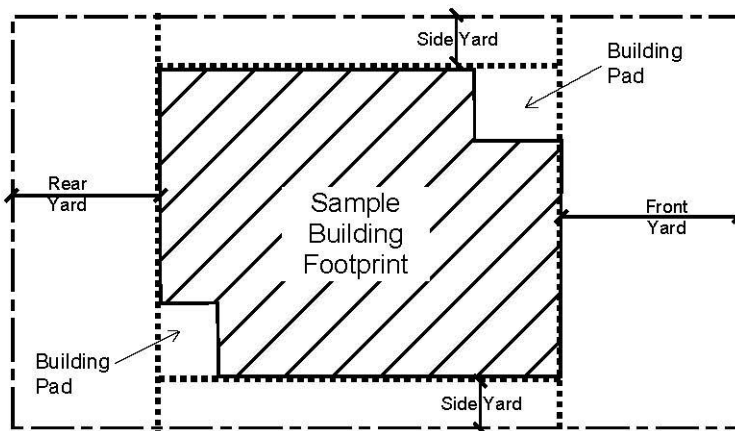

Proposed Image 4 – This image is proposed to be added to all applicable Side Setback Exceptions in Chapter 2 of the LMC to add clarity to Lot and Site Requirements. Additionally, this image is proposed to be added to the definition of Setback providing a clear visual increasing its readability and usability. This image shows that Setbacks do not encompass the entire area from a Property Line to a Structure.

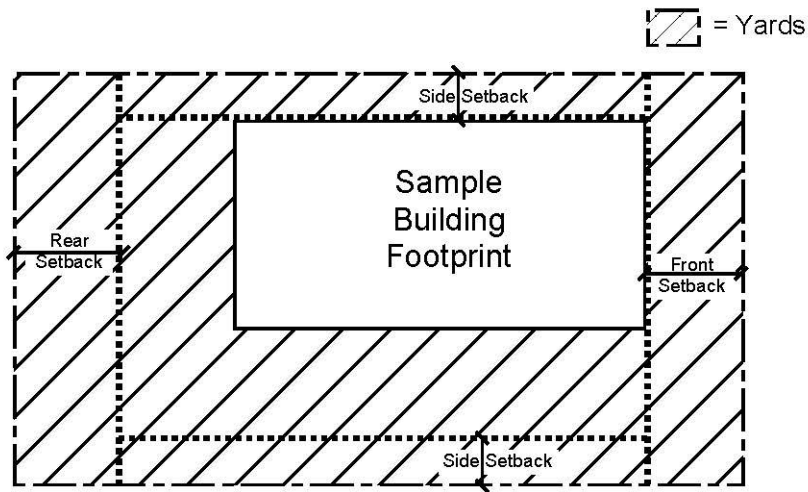

### **Process**

LMC amendments are processed according to LMC § 15-1-7. Amendments to the LMC require Planning Commission review and recommendation and City Council review and adoption. City Council final action may be appealed to a court of competent jurisdiction per LMC § 15-1-18. A public hearing is required by both the Planning Commission and City Council, with proper notice.

### **Notice**

Legal notice of a public hearing was posted in the required public spaces and public notice websites and published in the Park Record on May 24, 2018 and May 26, 2018, per requirements of the Land Management Code.

### **Public Input**

The Planning and Community Engagement Departments have created an outreach strategy, incorporating email messaging and a workshop session to discuss these amendments and their effect on community members. Staff will be discussing several related LMC amendments in this workshop which will be held in conjunction with the Outreach for Parking and Gravel LMC Amendments. The goals of the Outreach efforts are:

- To inform impacted neighborhood residents about LMC Updates for Setbacks/Yards and Parking/Gravel
- To address questions and concerns in a proactive manner.
- To provide an avenue for impacted residents to learn more about the proposed LMC updates

- Keep the information simple and straight forward. Explain the “why” and benefit.

All Outreach will occur before the scheduled July 12, 2018 City Council review of this item. Any comments and feedback will be forwarded to both the Planning Commission and City Council.

**Recommendation**

The Planning Department requests the Planning Commission open a public hearing and Discuss the possible Land Management Code amendments to the LMC definitions of Setback and Yard, applicable sections where these terms are listed, and images, as described in this report.

**Exhibits**

Exhibit A – Proposed Draft Ordinance, including Attachment 1: Proposed Redlines

**Exhibit A – Draft Ordinance**

**Ordinance No. 2018-XX**

**AN ORDINANCE AMENDING THE LAND MANAGEMENT CODE OF PARK CITY, UTAH, AMENDING 15-2.1 HISTORIC RESIDENTIAL-LOW DENSITY (HRL); 15-2.2 HISTORIC RESIDENTIAL (HR-1); 15-2.3 HISTORIC RESIDENTIAL (HR-2) DISTRICT; 15-2.4 HISTORIC RESIDENTIAL MEDIUM DISTRICT (HRM); 15-2.5 HISTORIC RECREATION COMMERCIAL (HRC) DISTRICT; 15-2.6 HISTORIC COMMERCIAL BUSINESS (HCB) DISTRICT; 15-2.7 RECREATION AND OPEN SPACE (ROS); 15-2.8 PROTECTED OPEN SPACE (POS); 15-2.9 RURAL ESTATE (E-40); 15-2.10 ESTATE (E); 15-2.11 SINGLE FAMILY (SF); 15-2.12 RESIDENTIAL (R-1); 15-2.13 RESIDENTIAL DEVELOPMENT (RD) DISTRICT; 15-2.14 RESIDENTIAL DEVELOPMENT-MEDIUM DENSITY (RDM) DISTRICT; 15-2.15 RESIDENTIAL-MEDIUM DENSITY (RM); 15-2.16 RECREATION COMMERCIAL (RC) DISTRICT; 15-2.18 GENERAL COMMERCIAL (GC) DISTRICT; 15-2.19 LIGHT INDUSTRIAL (LI) DISTRICT; 15-2.22 PUBLIC USE TRANSITION (PUT) DISTRICT; 15-2.23 COMMUNITY TRANSITION (CT) DISTRICT; 15-3 OFF-STREET PARKING; 15-4 SUPPLEMENTAL REGULATIONS; AND 15-15 DEFINED TERMS TO UPDATE REFERENCES TO SETBACKS AND YARDS.**

WHEREAS, the Land Management Code was adopted by the City Council of Park City, Utah to promote the health, safety and welfare of the residents, visitors, and property owners of Park City; and

WHEREAS, the Land Management Code implements the goals, objectives and policies of the Park City General Plan to maintain the quality of life and experiences for its residents and visitors and to promote unique experiences for residents and visitors.

WHEREAS, the City reviews the Land Management Code on a regular basis and identifies necessary amendments to address planning and zoning issues that have come up; to address specific LMC issues raised by Staff, Planning Commission, and City Council; and to align the Code with the Council's goals; and

WHEREAS, these proposed Land Management Code (LMC) amendments were reviewed for consistency with the recently adopted Park City General Plan; and

WHEREAS, Section 15-2.1-3 provides land use regulations including Setbacks for the Historic-Residential-Low Density (HRL) District; and

WHEREAS, Section 15-2.2-3 provides land use regulations including Setbacks for the Historic-Residential (HR-1) District; and

WHEREAS, Section 15-2.3-4 provides land use regulations including Setbacks for the Historic-Residential (HR-2) District; and



WHEREAS, Section 15-2.3-8 provides land use regulations including Setbacks for the Historic-Residential (HR-2) District Sub-Zone A; and

WHEREAS, Section 15-2.3-10 provides land use regulations including Setbacks for parking in the Historic-Residential (HR-2) District; and

WHEREAS, Section 15-2.4-4 provides land use regulations including Setbacks for the Historic Residential-Medium Density (HRM) District; and

WHEREAS, Section 15-2.4-5 provides land use regulations including Setbacks for multi-unit dwellings in the Historic Residential-Medium Density (HRM) District; and

WHEREAS, Section 15-2.4-9 provides land use regulations including Setbacks for Sullivan Road Access in the Historic Residential-Medium Density (HRM) District; and

WHEREAS, Section 15-2.5-3 provides land use regulations including Setbacks for the Historic Recreation Commercial (HRC) District; and

WHEREAS, Section 15-2.5-11 provides land use regulations including Setbacks for parking in the Historic Recreation Commercial (HRC) District; and

WHEREAS, Section 15-2.6-3 provides land use regulations including Setbacks for the Historic Commercial Business (HCB) District; and

WHEREAS, Section 15-2.6-5 provides land use regulations including Setbacks for parking in the Historic Commercial Business (HCB) District; and

WHEREAS, Section 15-2.7-3 provides land use regulations including Setbacks for the Recreation And Open Space (ROS) District; and

WHEREAS, Section 15-2.8-3 provides land use regulations including Setbacks for the Protected Open Space (POS) District; and

WHEREAS, Section 15-2.9-3 provides land use regulations including Setbacks for the Rural Estate (E-40) District; and

WHEREAS, Section 15-2.10-3 provides land use regulations including Setbacks for the Estate (E) District; and

WHEREAS, Section 15-2.11-3 provides land use regulations including Setbacks for the Single Family (SF) District; and

WHEREAS, Section 15-2.12-3 provides land use regulations including Setbacks for the Residential (R-1) District; and

WHEREAS, Section 15-2.12-4 provides land use regulations including Setbacks for Conditional Uses in the Residential (R-1) District; and

WHEREAS, Section 15-2.13-3 provides land use regulations including Setbacks for the Residential Development (RD) District; and

WHEREAS, Section 15-2.13-4 provides land use regulations including Setbacks for Building Height in the Residential Development (RD) District; and

WHEREAS, Section 15-2.14-3 provides land use regulations including Setbacks for the Residential Development-Medium Density (RDM) District; and

WHEREAS, Section 15-2.15-3 provides land use regulations including Setbacks for the Residential-Medium Density (RM) District; and

WHEREAS, Section 15-2.15-4 provides land use regulations including Setbacks for multi-unit dwellings in the Residential-Medium Density (RM) District; and

WHEREAS, Section 15-2.16-3 provides land use regulations including Setbacks for the Recreation Commercial (RC) District; and

WHEREAS, Section 15-2.16-5 provides land use regulations including Setbacks for single-family and duplex dwellings the Recreation Commercial (RC) District; and

WHEREAS, Section 15-2.16-8 provides land use regulations including Setbacks for parking in the Recreation Commercial (RC) District; and

WHEREAS, Section 15-2.18-3 provides land use regulations including Setbacks for the General Commercial (GC) District; and

WHEREAS, Section 15-2.19-5 provides land use regulations including Setbacks for the Light Industrial (LI) District; and

WHEREAS, Section 15-2.22-3 provides land use regulations including Setbacks for the Public Use Transition (PUT) District; and

WHEREAS, Section 15-2.23-3 provides land use regulations including Setbacks for the Community Transition (CT) District; and

WHEREAS, Section 15-3-3 provides land use regulations including Setbacks for off-street parking; and

WHEREAS, Section 15-3-4 provides parking restrictions including parking in Setback areas and parking Recreational Vehicles; and

WHEREAS, Section 15-4-2 provides land use regulations including Setbacks for fences and retaining walls; and

WHEREAS, Section 15-4-9 provides land use regulations including Setbacks for child care facilities; and

WHEREAS, Section 15-15-1 provides definitions of terms, how words shall be used, interpreted, and defined as set forth in the Land Management Code; and

WHEREAS, on May 26, 2018, legal notice was published in the Park Record as required by the Land Management Code; and

WHEREAS, the Planning Commission duly noticed and conducted public hearings at the regularly scheduled meeting on June 13, 2018 and forwarded a \_\_\_\_\_ recommendation to City Council; and

WHEREAS, the City Council duly noticed and conducted a public hearing at its regularly scheduled meeting on July 12, 2018; and

WHEREAS, it is in the best interest of the residents and visitors of Park City, Utah to amend the Land Management Code to be consistent with the values and goals of the Park City General Plan and the Park City Council; to protect health and safety and maintain the quality of life for its residents and visitors.

NOW, THEREFORE, BE IT ORDAINED by the City Council of Park City, Utah as follows:

SECTION 1. AMENDMENTS TO TITLE 15 - Land Management Code Chapter 15-2 Zoning Districts Section 15-2.1-3, 15-2.2-3, 15-2.3-4, 15-2.3-8, 15-2.3-10, 15-2.4-4, 15-2.4-5, 15-2.4-9, 15-2.5-3, 15-2.5-11, 15-2.6-3, 15-2.6-5, 15-2.7-3, 15-2.8-3, 15-2.9-3, 15-2.10-3, 15-2.11-3, 15-2.12-3, 15-2.12-4, 15-2.13-3, 15-2.13-4, 15-2.14-3, 15-2.15-3, 15-2.15-4, 15-2.16-3, 15-2.16-5, 15-2.16-8, 15-2.18-3, 15-2.19-5, 15-2.22-3, and 15-2.23-3, Chapter 15-3 Off-Street Survey Section 15-3-4 and 15-3-4, Chapter 15-4 Supplemental Regulations Section 15-4-2 and 15-4-9, and Chapter 15 Defined Terms Section 15-15-1. The recitals above are incorporated herein as findings of fact. The applicable Sections of the Land Management Code of Park City is hereby amended as redlined (see Attachment 1).

SECTION 2. EFFECTIVE DATE. This Ordinance shall be effective upon publication.

PASSED AND ADOPTED this 12<sup>th</sup> day of July, 2018

PARK CITY MUNICIPAL CORPORATION

---

Andy Beerman, Mayor

Attest:

---

City Recorder

Approved as to form:

---

Mark Harrington, City Attorney

## 15-2.1 Historic Residential-Low Density (HRL) District

### 15-2.1-3 Lot And Site Requirements

C. **BUILDING PAD (HRL DISTRICT)**. The Building Pad is the Lot Area minus required Front, Rear and Side ~~Yard~~ **Setback** Areas.

D. **BUILDING FOOTPRINT (HRL DISTRICT)**.

TABLE 15-2.1.

Lot Depth </= ft. **	Lot Width, ft. up to:	Side <del>Yards</del> <b>Setbacks</b> Min. Total		Lot Area Sq. ft.	Bldg. Pad Sq. ft.	Max. Bldg. Footprint Sq. ft.
75 ft.	37.5*	3 ft.	6 ft.	2,813	1,733	1,201
75 ft.	50.0	5 ft.	10 ft.	3,750	2,200	1,519
75 ft.	62.5	5 ft.	14 ft.	4,688	2,668	1,801
75 ft.	75.0	5 ft.	18 ft.	5,625	3,135	2,050
75 ft.	87.5	10 ft.	24 ft.	6,563	3,493	2,269
75 ft.	100.0	10 ft.	24 ft.	7,500	4,180	2,460
75 ft.	Greater than 100.0	10 ft.	30 ft.	Greater than 7,500	Per Setbacks and Lot Area	Per Formula

\* for existing 25' wide lots, Use HR-1 standards.

\*\* for lots > 75' in depth use Footprint formula and Table 15-2.1a for Front and Rear Setbacks.

E. **FRONT AND REAR ~~YARDS~~ **SETBACKS****. Front and Rear ~~Yards~~ **Setbacks** are as follows:

TABLE 15-2.1a

Lot Depth	Minimum Front/Rear Setback	Total of Setback
Up to 75 ft., inclusive	10 ft.	20 ft.
From 75 ft. to 100 ft.	12 ft.	25 ft.
Over 100 ft.	15 ft.	30 ft.

F. **FRONT ~~YARD~~ **SETBACK EXCEPTIONS****. The Front ~~Yard~~ **Setback** must be open and free of any Structure except:

1. Fences and walls not more than four feet (4') in height, or as permitted in Section 15-4-2 Fences and Walls. On Corner Lots, Fences more than three feet (3') in



height are prohibited within twenty-five feet (25') of the intersection, at back of curb.

2. Uncovered steps leading to the Main Building, provided the steps are not more than four feet (4') in height from Final Grade, not including any required handrail, and do not cause any danger or hazard to traffic by obstructing the view of the Street or intersection.

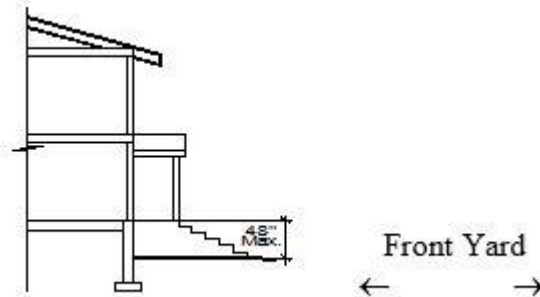

3. Decks, porches, or Bay Windows not more than ten feet (10') wide, projecting not more than three feet (3') into the Front ~~Yard-Setback~~.
4. Roof overhangs, eaves, or cornices projecting not more than three feet (3') into the Front ~~Yard-Setback~~.
5. Sidewalks and pathways.
6. Driveways leading to a garage or Parking Area. No portion of a Front Yard, except for patios, driveways, allowed Parking Areas and sidewalks, may be Hard-Surfaced or graveled.

G. **REAR ~~YARD-SETBACK~~ EXCEPTIONS**. The Rear ~~Yard-Setback~~ must be open and free of any Structure except:

1. Bay Windows not more than ten feet (10') wide, projecting not more than two feet (2') into the Rear ~~Yard-Setback~~.
2. Chimneys not more than five feet (5') wide, projecting not more than two feet (2') into the Rear ~~Yard-Setback~~.
3. Window wells or light wells extending not more than four feet (4') into the Rear ~~Yard-Setback~~.
4. Roof overhangs or eaves projecting not more than two feet (2') into the Rear ~~Yard-Setback~~.
5. Window sills, belt courses, cornices, trim, exterior siding, or other ornamental features projecting not more than six inches (6") into the Rear ~~Yard-Setback~~.
6. A detached Accessory Building not more than eighteen feet (18') in height, located a minimum of five feet (5') behind the front facade of the Main Building, and maintaining a minimum Rear ~~Yard~~ Setback of one foot (1'). Such Structure must not cover over fifty percent (50%) of the Rear Yard. See the following illustration:

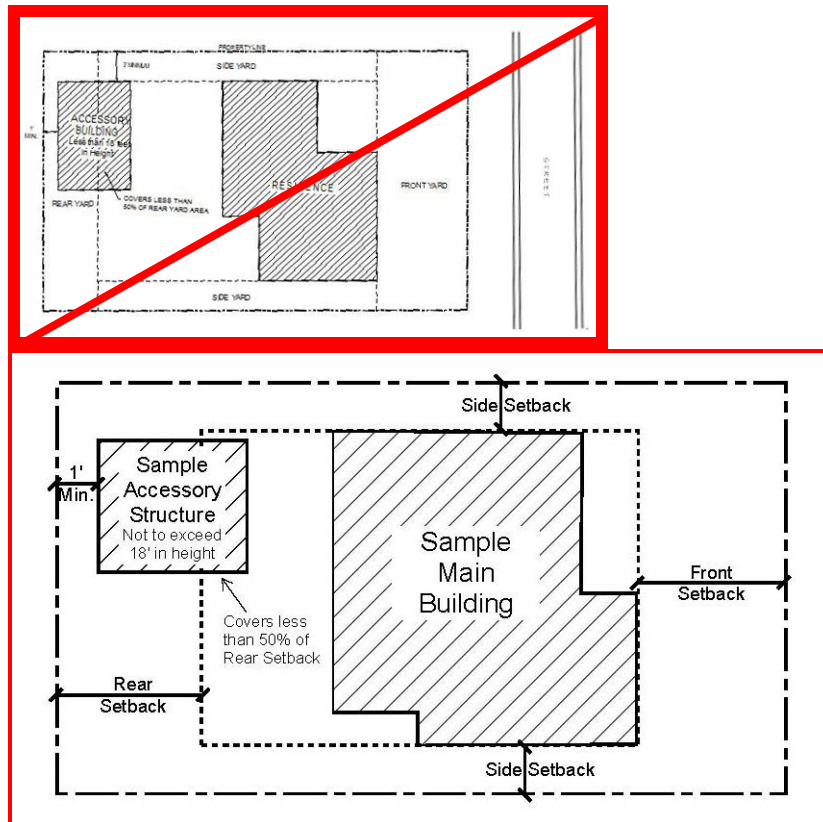

7. Hard-Surfaced Parking Areas subject to the same location requirements as a Detached Accessory Building.
8. Mechanical equipment (which must be screened), hot tubs, or similar Structures located at least three feet (3') from the Rear Lot Line.
9. Fences or walls as permitted in Section 15-4-2 Fences and Walls.
10. Patios, decks, pathways, steps, or similar Structures not more than thirty inches (30") above Final Grade, located at least one foot (1') from the Rear Lot Line.
11. Pathways or Steps connecting to a City staircase or pathway.

**H. SIDE YARDS SETBACK.**

1. The minimum Side ~~Yard-Setback~~ is three feet (3'), but increases for Lots greater than thirty seven and one-half feet (37.5') in Width, as per Table 15-2.1.above.
2. On Corner Lots, the ~~minimum~~ Side Yard that faces a ~~side Street~~ or platted Right-of-Way is ~~considered a Front Yard and the minimum Setback is~~ five feet (5').

**I. SIDE YARD SETBACK EXCEPTIONS.** The Side ~~Yard-Setback~~ must be open and free of any Structure except:

1. Bay Windows not more than ten feet (10') wide, projecting not more than two feet (2') into the Side ~~Yard-Setback~~.
2. Chimneys not more than five feet (5') wide, projecting not more than two feet (2') into the Side ~~Yard-Setback~~.
3. Window wells or light wells projecting not more than four feet (4') into the Side ~~Yard-Setback~~.<sup>1</sup>

4. Roof overhangs or eaves projecting not more than two feet (2') into the Side ~~Yard~~ **Setback**. A one foot (1') eave overhang is permitted on Lots with a ~~side-Yard~~ **Side Setback** less than five feet (5').<sup>1</sup>
5. Window sills, belt courses, trim, exterior siding, cornices, or other ornamental features projecting not more than six inches (6") into the Side ~~Yard~~ **Setback**.
6. Patios, decks, pathways, steps, or similar Structures not more than thirty inches (30") in height from Final Grade.
7. Fences or walls, as permitted in Section 15-4-2 Fences and Walls.
8. A driveway leading to a garage or Parking Area.
9. Pathways or steps connecting to a City staircase or pathway.
10. A detached Accessory Building, not more than eighteen feet (18') in height, located a minimum of five feet (5') behind the front Facade of the Main Building, maintaining a minimum Side ~~Yard~~ **Setback** of three feet (3'). See the following illustration:

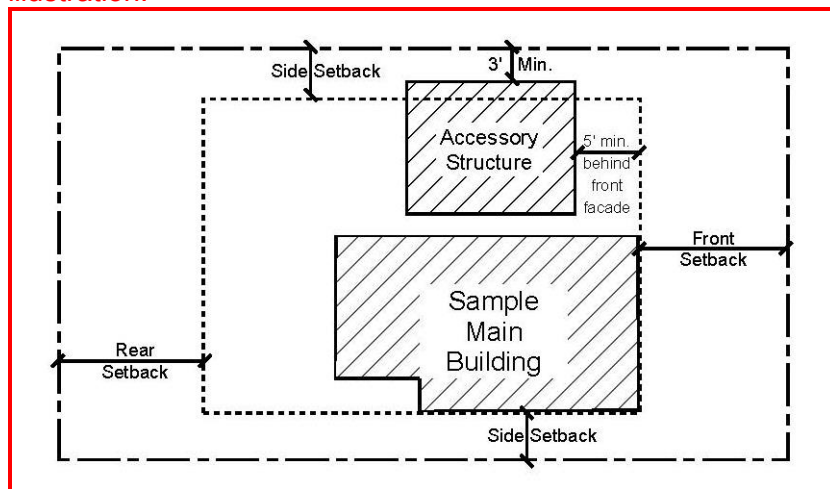

11. Mechanical equipment (which must be screened), hot tubs, or similar Structures, located at least three feet (3') from the Side Lot Line.

<sup>1</sup>Applies only to Lots with a Side ~~Yard~~ **Setback** of five feet (5') or greater.

## 15-2.2 Historic Residential (HR-1) District

### 15-2.2-3 Lot And Site Requirements

C. **BUILDING PAD (HR-1 DISTRICT).** The Building Pad is the Lot Area minus required Front, Rear, and Side ~~Yard~~ **Setback** Areas.

D. **BUILDING FOOTPRINT (HR-1 DISTRICT).**

TABLE 15-2.2.

Lot Depth < /= ft. *	Lot Width, ft. up to:	Side <del>Yard</del> <b>Setback</b> Min. Total	Lot Area Sq. ft.	Bldg. Pad Sq. ft.	Max. Bldg. Footprint Sq. ft.

75 ft.	25.0	3 ft.	6 ft.	1,875	1,045	844
75 ft.	37.5	3 ft.	6 ft.	2,813	1,733	1,201
75 ft.	50.0	5 ft.	10 ft.	3,750	2,200	1,519
75 ft.	62.5	5 ft.	14 ft.	4,688	2,668	1,801
75 ft.	75.0	5 ft.	18 ft.	5,625	3,135	2,050
75 ft.	87.5	10 ft.	24 ft.	6,563	3,493	2,269
75 ft.	100.0	10 ft.	24 ft.	7,500	4,180	2,460
75 ft.	Greater than 100.0	10 ft.	30 ft.	Greater than 75 ft.	Per Setbacks and Lot Area	Per Formula

\*~~for~~ For Lots > 75' in depth use footprint formula and Table 15-2.2a for ~~front~~ Front and ~~rear~~ Rear Setbacks.

- E. **FRONT AND REAR YARDS SETBACKS**. Front and Rear ~~Yards-Setbacks~~ are as follows:

TABLE 15-2.2a

Lot Depth	Minimum Front/Rear Setback	Total of Setbacks
Up to 75 ft., inclusive	10 ft.	20 ft.
From 75 ft. to 100 ft.	12 ft.	25 ft.
Over 100 ft.	15 ft.	30 ft.

- F. **FRONT YARD SETBACK EXCEPTIONS**. The Front ~~Yard-Setback~~ must be open and free of any Structure except:
1. Fences or walls not more than four feet (4') in height, or as permitted in Section 15-4-2, Fences and Walls. On Corner Lots, Fences more than three feet (3') in height are prohibited within twenty-five feet (25') of the intersection, at back of curb.
  2. Uncovered steps leading to the Main Building; provided the steps are not more than four feet (4') in height from Final Grade, not including any required handrail, and do not cause any danger or hazard to traffic by obstructing the view of the



Street or intersection.

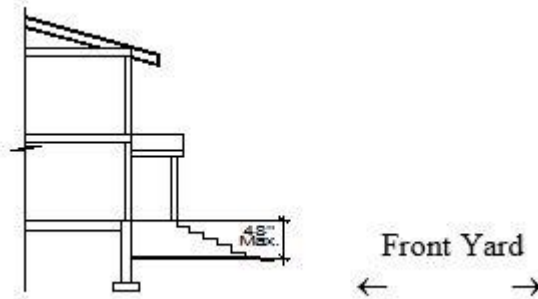

3. Decks, porches, or Bay Windows not more than ten feet (10') wide, projecting not more than three feet (3') into the Front ~~Yard-Setback~~.
4. Roof overhangs, eaves or cornices projecting not more than three feet (3') into the Front ~~Yard-Setback~~.
5. Sidewalks and pathways.
6. Driveways leading to a Garage or Parking Area. No portion of a Front Yard, except for patios, driveways, allowed Parking Areas and sidewalks, may be Hard-Surfaced or graveled.

G. **REAR YARD SETBACK EXCEPTIONS**. The Rear ~~Yard-Setback~~ must be open and free of any Structure except:

1. Bay Windows not more than ten feet (10') wide, and projecting not more than two feet (2') into the Rear ~~Yard-Setback~~.
2. Chimneys not more than five feet (5') wide, projecting not more than two feet (2') into the Rear ~~Yard-Setback~~.
3. Window wells or light wells extending not more than four feet (4') into the Rear ~~Yard-Setback~~.
4. Roof overhangs or eaves projecting not more than two feet (2') into the Rear ~~Yard-Setback~~.
5. Window sills, belt courses, cornices, trim, exterior siding, or other ornamental features projecting not more than six inches (6") into the Rear ~~Yard-Setback~~.
6. A detached Accessory Building not more than eighteen feet (18') in height, located a minimum of five feet (5') behind the front facade of the Main Building, and maintaining a minimum Rear ~~Yard~~ Setback of one foot (1'). Such Structure must not cover over fifty percent (50%) of the Rear Yard. See the following illustration:

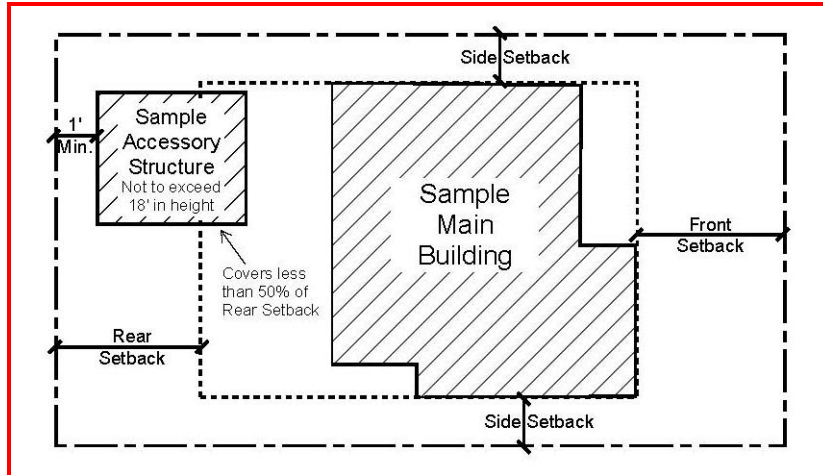
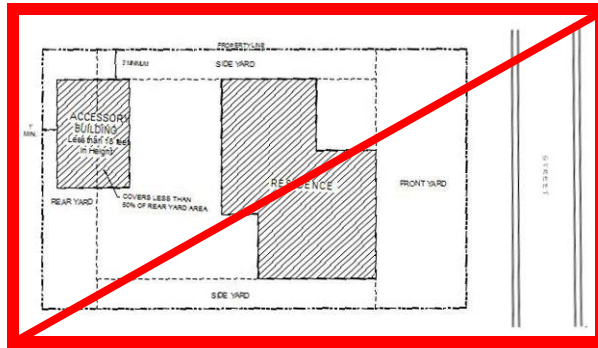

7. A Hard-Surfaced Parking Area subject to the same location requirements as a Detached Accessory Building.
8. Mechanical equipment (which must be screened), hot tubs, or similar Structures located at least three feet (3') from the Rear Lot Line.
9. Fences or walls as permitted in Section 15-4-2, Fences and Walls.
10. Patios, decks, pathways, steps, or similar Structures not more than thirty inches (30") above Final Grade.
11. Pathways or steps connecting to a City staircase or pathway.

**H. SIDE YARD-SETBACK.**

1. The minimum Side **Yard-Setback** is three feet (3'), but increases for Lots greater than thirty seven and one-half feet (37.5') in Width, as per Table 15-2.2.above.
2. On Corner Lots, the minimum Side **Yard-Setback** that faces a side Street or platted Right-of-Way is five feet (5').
3. A Side **Yard-Setback** between connected Structures is not required where Structures are designed with a common wall on a Property Line, each Structure is located on an individual Lot, the Lots are burdened with a party wall agreement in a form approved by the City Attorney and Chief Building Official, all applicable Building and Fire Code requirements are met, and the Use is an Allowed or Conditional Use in the Zoning District.
  - a. Exterior Side **Yards-Setbacks** shall be based on the required minimum Side **Yard-Setback** for each Lot; however the Planning Commission may consider increasing exterior Side **Yards-Setbacks** during Conditional Use

Permit review to mitigate potential impacts on adjacent Property. Side ~~Yard-Setback~~ exceptions continue to apply.

- b. Building Footprint shall be based on the total lot Area of the underlying Lots. The Planning Commission may consider decreasing Building Footprint during Conditional Use Permit review to mitigate potential impacts on adjacent Property.

I. **SIDE YARD SETBACK EXCEPTIONS**. The Side ~~Yard-Setback~~ must be open and free of any Structure except:

1. Bay Windows not more than ten feet (10') wide, and projecting not more than two feet (2') into the Side ~~Yard-Setback~~.<sup>1</sup>
2. Chimneys not more than five feet (5') wide projecting not more than two feet (2') into the Side ~~Yard-Setback~~.<sup>1</sup>
3. Window wells or light wells projecting not more than four feet (4') into the Side ~~Yard-Setback~~.<sup>1</sup>
4. Roof overhangs or eaves projecting not more than two feet (2') into the Side ~~Yard-Setback~~. A one foot (1') roof or eave overhang is permitted on Lots with a Side ~~Yard-Setback~~ of less than five feet (5').<sup>1</sup>
5. Window sills, belt courses, trim, cornices, exterior siding, or other ornamental features projecting not more than six inches (6") into the Side ~~Yard-Setback~~.
6. Patios, decks, pathways, steps, or similar Structures not more than thirty inches (30") in height above Final Grade.
7. Fences, walls, or retaining walls as permitted in Section 15-4-2, Fences and Walls.
8. Driveways leading to a garage or Parking Area.
9. Pathways or steps connecting to a City staircase or pathway.
10. Detached Accessory Buildings not more than eighteen feet (18') in height, located a minimum of five feet (5') behind the Front facade of the Main Building, maintaining a minimum Side ~~Yard-Setback~~ of three feet (3'). See the following illustration:

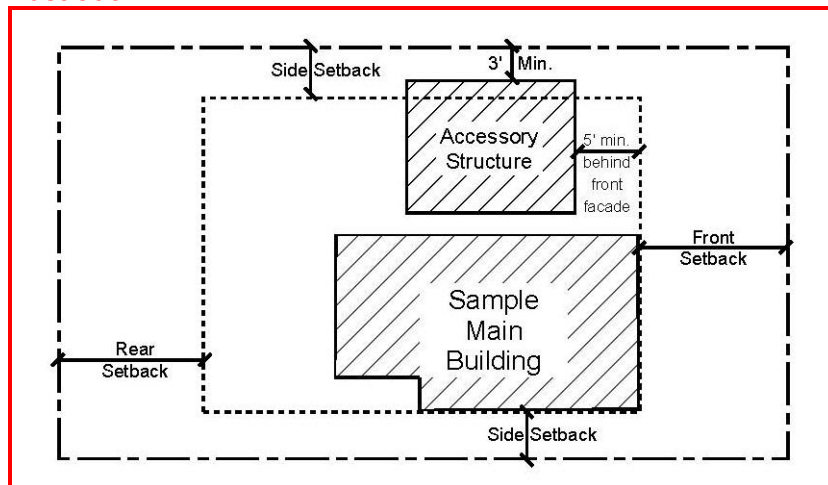

11. Mechanical equipment (which must be screened), hot tubs, or similar Structures located at least three feet (3') from the Side Lot Line.

<sup>1</sup>Applies only to Lots with a minimum Side ~~Yard-Setback~~ of five feet (5').

**15-2.3 Historic Residential (HR-2) District**

**15-2.3-4 Lot And Site Requirements**

- C. **BUILDING PAD (HR-2 DISTRICT).** The Building Pad is the Lot Area minus required Front, Rear, and Side ~~Yard-Setback~~ Areas.
- D. **BUILDING FOOTPRINT (HR-2 DISTRICT).**

TABLE 15-2.3.

Lot Depth < /= ft. *	Lot Width, ft. Up to:	Side <del>Yards</del> <b>Setbacks</b> Min. Total, ft.		Lot Area Sq. ft.	Bldg. Pad Sq. ft.	Max Bldg. Footprint
75 ft.	25.0	3 ft.	6 ft.	1,875	1,045	844
75 ft.	37.5	3 ft.	6 ft.	2,813	1,733	1,201
75 ft.	50.0	5 ft.	10 ft.	3,750	2,200	1,519
75 ft.	62.5	5 ft.	14 ft.	4,688	2,668	1,801
75 ft.	75.0	5 ft.	18 ft.	5,625	3,135	2,050
75 ft.	87.5	10 ft.	24 ft.	6,563	3,493	2,270
75 ft.	100.0	10 ft.	24 ft.	7,500	4,180	2,460
75 ft.	Greater than 100.0	10 ft.	30 ft.	Greater than 7,500 ft.	Per Setbacks and Lot Area	Per formula

\*for Lots > 75' in depth use footprint formula and Table 15-2.3a for Front and Rear Setbacks.

- E. **FRONT ~~YARD-SETBACK~~ EXCEPTIONS.** The Front ~~Yard-Setback~~ must be open and free of any Structure except:
  1. Fences or walls not more than four feet (4') in height or as permitted in Section 15-4-2, Fences and Walls. On Corner Lots, Fences more than three feet (3') in height are prohibited within twenty-five feet (25') of the intersection, at the back of curb.
  2. Uncovered steps leading to the Main Building; provided, the steps are not more than four feet (4') in height from Final Grade, not including any required handrail, and do not cause any danger or hazard to traffic by obstructing the view of the



Street or intersection.

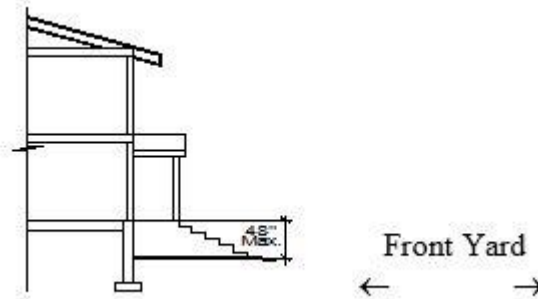

3. Decks, porches, or Bay Windows not more than ten feet (10') wide, projecting not more than three feet (3') into the Front ~~Yard-Setback~~.
  4. Roof overhangs, eaves or cornices projecting not more than three feet (3') into the Front ~~Yard-Setback~~.
  5. Sidewalks and pathways.
  6. Driveways leading to a Garage or Parking Area. No portion of a Front Yard except for driveways, allowed Parking Areas and sidewalks, may be Hard-Surfaced or graveled.
  7. Single car detached Garages approved as part of a Master Planned Development in Subzone A.
- F. **REAR YARD SETBACK EXCEPTIONS**. The Rear ~~Yard-Setback~~ must be open and free of any Structure except:
1. Bay Windows not more than ten feet (10') wide, and projecting not more than two feet (2') into the Rear ~~Yard-Setback~~.
  2. Chimneys not more than five feet (5') wide, projecting not more than two feet (2') into the Rear ~~Yard-Setback~~.
  3. Window wells or light wells projecting not more than four feet (4') into the Rear ~~Yard-Setback~~.
  4. Roof overhangs or eaves projecting not more than two feet (2') into the Rear ~~Yard-Setback~~.
  5. Window sills, belt courses, cornices, trim, exterior siding, or other ornamental features projecting not more than six inches (6") into the Rear ~~Yard-Setback~~.
  6. Detached Accessory Buildings not more than eighteen feet (18') in height, located a minimum of five feet (5') behind the front facade of the Main Building, and maintaining a minimum Rear ~~Yard-Setback~~ of one foot (1'). Such Structure must not cover over fifty percent (50%) of the Rear Yard. See the following illustration:

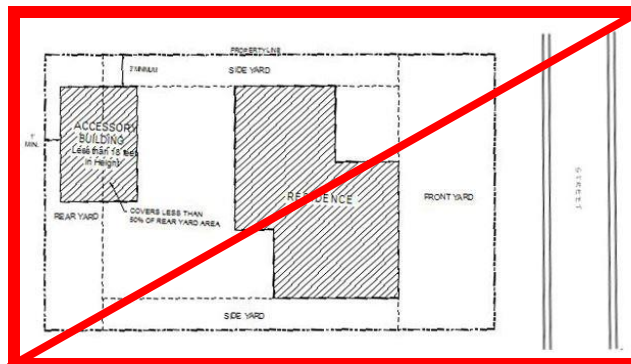

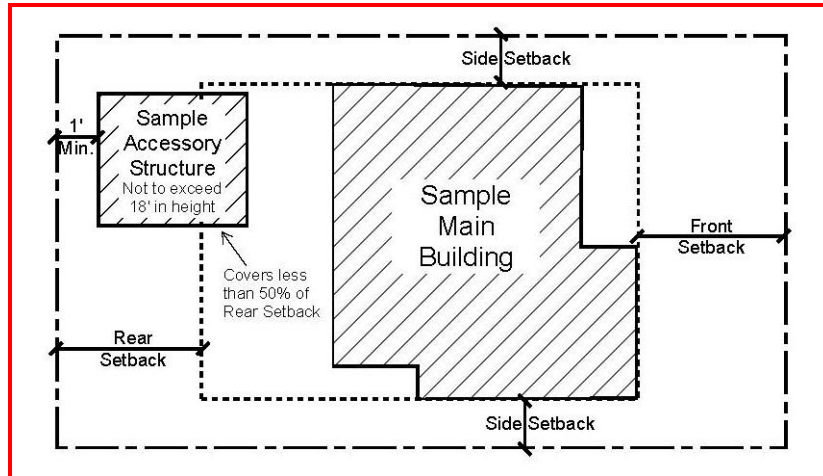

7. Hard-Surfaced Parking Areas subject to the same location requirements as a detached Accessory Building.
8. Mechanical equipment (which must be screened), hot tubs, or similar Structures located at least three feet (3') from the Rear Lot Line.
9. Fences or walls not more than six feet (6') in height or as permitted in Section 15-4-2.
10. Patios, decks, steps, pathways, or similar Structures not more than thirty inches (30") above Final Grade.
11. Pathways or steps connecting to a City staircase or pathway.

**G. SIDE YARD-SETBACK.**

1. The minimum Side ~~Yard-Setback~~ is three feet (3'), but increases for Lots greater than thirty-seven and one-half feet (37.5') in width, as per Table 15-2.3 above.
2. On Corner Lots, the ~~minimum~~ Side Yard that faces a ~~side~~ Street or platted Right-of-Way is ~~considered a Front Yard and the minimum Setback is five feet (5')~~.
3. A Side ~~Yard-Setback~~ between connected Structures is not required where Structures are designed with a common wall on a Property Line, each Structure is located on an individual Lot, the Lots are burdened with a party wall agreement in a form approved by the City Attorney and Chief Building Official, all applicable Building and Fire Code requirements are met, and the Use is an Allowed or Conditional Use in the Zoning District.
  - a. Exterior Side ~~Yards-Setbacks~~ shall be based on the required minimum Side ~~Yard-Setback~~ for each Lot; however the Planning Commission may consider increasing exterior Side ~~Yards-Setbacks~~ during Conditional Use Permit review to mitigate potential impacts on adjacent Property. Side ~~Yard-Setback~~ exceptions continue to apply.
  - b. Building Footprint shall be based on the total lot Area of the underlying Lots. The Planning Commission may consider decreasing Building Footprint during Conditional Use Permit review to mitigate potential impacts on adjacent Property.

**H. SIDE YARD SETBACK EXCEPTIONS.** The Side ~~Yard-Setback~~ must be open and free of any Structure except:

1. Bay Windows not more than ten feet (10') wide, and projecting not more than two feet (2') into the Side ~~Yard-Setback~~.<sup>1</sup>
2. Chimneys not more than five feet (5') wide, projecting not more than two feet (2') into the Side ~~Yard-Setback~~.<sup>1</sup>

3. Window wells or light wells projecting not more than four feet (4') into the Side ~~Yard-Setback~~.<sup>1</sup>
4. Roof overhangs or eaves projecting not more than two feet (2') into the Side ~~Yard-Setback~~. A one foot (1') roof or eave overhang is permitted on Lots with a Side Yard of less than five feet (5').<sup>1</sup>
5. Window sills, belt courses, trim, cornices, exterior siding, or other ornamental features projecting not more than six inches (6") into the Side ~~Yard-Setback~~.
6. Patios, decks, pathways, steps, or similar Structures not more than thirty inches (30") in height from Final Grade.
7. Fences or walls not more than six feet (6') in height or as permitted in Section 15-4-2.
8. Driveways leading to a garage or Parking Area.
9. Pathway or steps connecting to a City staircase or pathway.
10. Detached Accessory Buildings not more than eighteen feet (18') in height, located a minimum of five feet (5') behind the front facade of the Main Building, maintaining a minimum Side ~~Yard-Setback~~ of three feet (3'). See the following illustration:

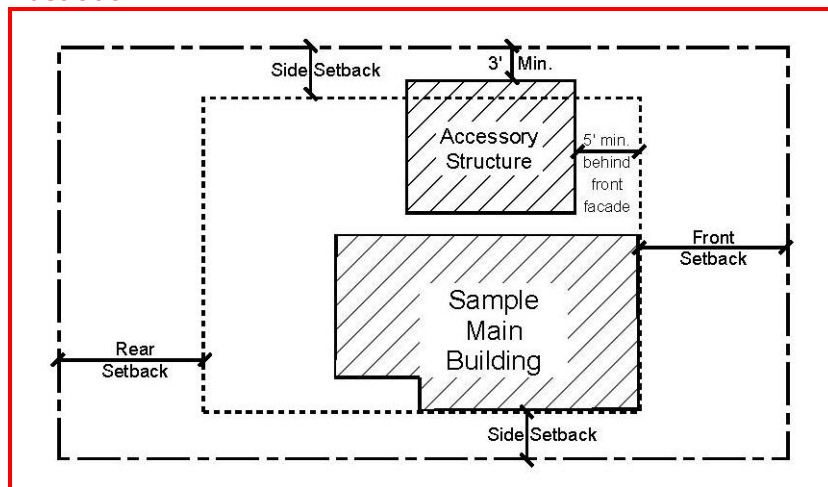

11. Mechanical equipment (which must be screened), hot tubs, or similar Structures located at least three feet (3') from the Side Lot Line.

<sup>1</sup>Applies only to Lots with a minimum Side ~~Yard-Setback~~ of five feet (5')

### 15-2.3-8 Special Requirements For Master Planned Developments And Conditional Use Permits In Sub-Zone A

#### A. SUB-ZONE A.

2. All Buildings within the HR-2 portion of the development must meet the minimum Side and Front ~~Yard~~ Setbacks of the HR-2 District as stated in Section 15-2.3-4, unless the Planning Commission grants an exception to this requirement during the MPD review and the development is consistent with the MPD Section 15-6-5(C). Below Grade Structures, such as parking structures and Commercial Floor Area extending from Main Street beneath a residential Structure or Structures on Park Avenue may occupy Side ~~Yard~~ Setbacks subject to Building and Fire Codes

and trespass agreements.

### 15-2.3-10 Parking Regulations

- D. A common Parking Structure may occupy below Grade Side ~~Yards~~ **Setbacks** between participating Developments if the Structure maintains all Setbacks above Grade. Common Parking Structures are subject to a Conditional Use review, Section 15-1-10.

## 15-2.4 Historic Residential-Medium Density (HRM) District

### 15-2.4-4 Lot And Site Requirements

C. **FRONT ~~YARD~~ SETBACK.**

1. The minimum Front ~~Yard-Setback~~ for Single-Family, Duplex Dwellings, and Accessory Buildings is fifteen feet (15'). If the Lot depth is seventy five feet (75') or less, then the minimum Front ~~Yard-Setback~~ is ten feet (10').
2. New Front Facing Garages for Single Family and Duplex Dwellings must be at least twenty feet (20') from the Front Lot Line.
3. See Section 15-2.4-5 for special requirements for Triplexes and Multi-Unit Dwellings.

D. **FRONT ~~YARD~~ SETBACK EXCEPTIONS.** The Front ~~Yard-Setback~~ must be open and free of any Structure except:

1. Fences, walls, and retaining walls not more than four feet (4') in height, or as permitted in Section 15-4-2. On Corner Lots, Fences more than three (3') in height are prohibited within twenty-five feet (25') of the intersection, at back of curb.
2. Uncovered steps leading to the Main Building; provided the steps are not more than four feet (4') in height from Final Grade, not including any required handrail, and do not cause any danger or hazard to traffic by obstructing the view of a Street or intersection.

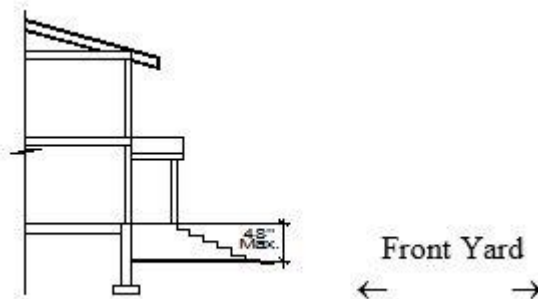

3. Decks, porches, and Bay Windows, not more than ten feet (10') wide, projecting not more than three feet (3') into the Front ~~Yard-Setback~~.
4. Roof overhangs, eaves, and cornices projecting not more than three feet (3') into the Front ~~Yard-Setback~~.
5. Sidewalks, patios, and pathways.



6. Driveways leading to a garage or Parking Area. No portion of a Front Yard except for approved driveways and patios, allowed Parking Areas, and sidewalks may be Hard-Surfaced or graveled.

**E. REAR ~~YARD-SETBACK~~.**

1. The minimum Rear ~~Yard-Setback~~ is ten feet (10') for all Main Buildings, and one foot (1') for detached Accessory Buildings.
2. See Section 15-2.4-5, Special Requirements for Multi-Unit Dwellings.

**F. REAR ~~YARD-SETBACK~~ EXCEPTIONS.**

1. Bay Windows not more than ten feet (10') wide, projecting not more than two feet (2') into the Rear ~~Yard-Setback~~.
2. Chimneys not more than five feet (5') wide, projecting not more than two feet (2') into the Rear ~~Yard-Setback~~.
3. Window wells and light wells projecting not more than four feet (4') into the Rear ~~Yard-Setback~~.
4. Roof overhangs and eaves projecting not more than three feet (3') into the Rear ~~Yard-Setback~~.
5. Window sills, belt courses, cornices, trim, and other ornamental features projecting not more than six inches (6") beyond the window or main Structure to which they are attached.
6. A detached Accessory Building not more than eighteen feet (18') in height, located a minimum of five feet (5') behind the front façade of the Main Building, and maintaining a minimum Rear ~~Yard-Setback~~ of one foot (1'). Such Structure must not cover over fifty percent (50%) of the Rear Yard. See the following illustration:

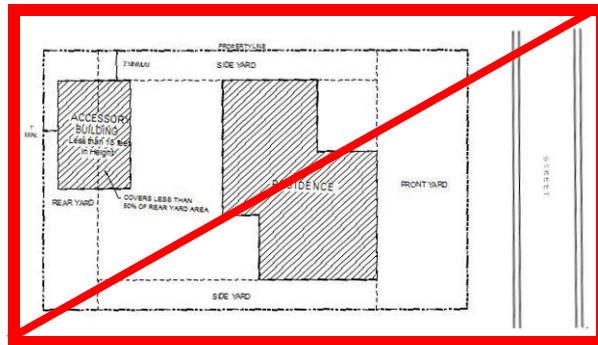

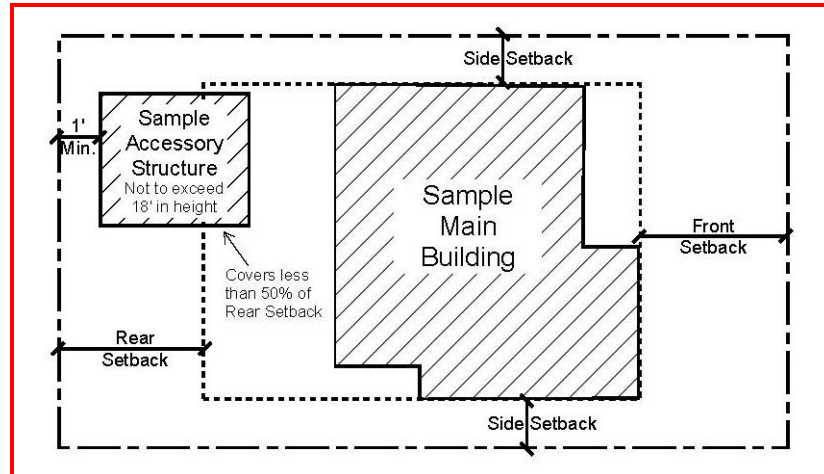

7. A Hard-Surfaced Parking Area subject to the same location requirements as a detached Accessory Building.
8. Mechanical equipment (which must be screened), hot tubs, or similar Structures located at least three feet (3') from the Rear Lot Line.
9. Fences, walls, and retaining walls not over six feet (6') in height, or as permitted in Section 15-4-2.
10. Patios, decks, pathways, steps, and similar Structures not more than thirty inches (30") above Final Grade.

**G. SIDE YARD SETBACK.**

1. The minimum Side ~~Yard-Setback~~ for any Single Family, Duplex Dwelling or Accessory Building is five feet (5').
2. The minimum Side ~~Yard-Setback~~ for Lots twenty-five feet (25') wide or less is three feet (3').
3. A Side ~~Yard-Setback~~ between connected Structures is not required where Structures are designed with a common wall on a Property Line, each Structure is located on an individual Lot, the Lots are burdened with a party wall agreement in a form approved by the City Attorney and Chief Building Official, all applicable Building and Fire Code requirements are met, and the Use is an Allowed or Conditional Use in the Zoning District.
  - a. Exterior Side ~~Yards-Setbacks~~ shall be based on the required minimum Side ~~Yard-Setback~~ for each Lot; however the Planning Commission may consider increasing exterior Side ~~Yards-Setbacks~~ during Conditional Use Permit review to mitigate potential impacts on adjacent Property. Side ~~Yard-Setback~~ exceptions continue to apply.
  - b. The longest dimension of a Building joined at the Property Line may not exceed one hundred feet (100').
4. The minimum Side ~~Yard-Setback~~ for a detached Accessory Building, not greater than eighteen feet (18') in height, located at least five feet (5') behind the front

facade of the Main Building, is three feet (3'). See the following illustration:

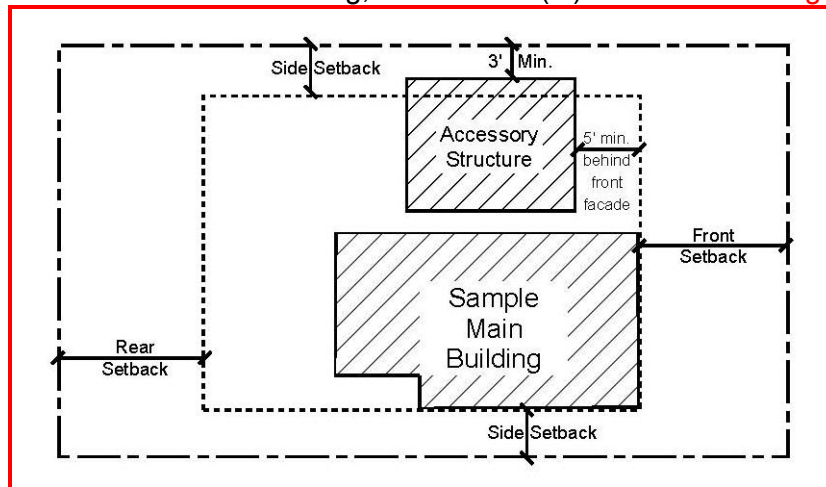

5. On Corner Lots, the ~~minimum~~ Side Yard that faces a ~~side~~ Street or platted Right-of-Way is ~~considered a Front Yard~~, and the ~~minimum Setback~~ is ten feet (10') for both Main and Accessory Buildings.
6. See Section 15-2.4-5 special requirements for Multi-Unit Dwellings.

H. **SIDE YARD SETBACK EXCEPTIONS**. The Side ~~Yard-Setback~~ must be open and free of any Structure except:

1. Bay Windows not more than ten feet (10') wide, projecting not more than two feet (2') into the Side ~~Yard-Setback~~.<sup>1</sup>
2. Chimneys not more than five feet (5') wide, projecting not more than two feet (2') into the Side ~~Yard-Setback~~.<sup>1</sup>
3. Window well and light wells projecting not more than four feet (4') into the Side ~~Yard-Setback~~.<sup>1</sup>
4. Roof overhangs and eaves projecting not more than two feet (2') into the Side ~~Yard-Setback~~.<sup>1</sup>
5. Window sills, belt courses, cornices, trim, and other ornamental features projecting not more than six inches (6") beyond the window or main Structure to which they are attached.
6. Patios, decks, pathways, steps, and similar Structures not more than thirty inches (30") in height above Final Grade.
7. Fences, walls and retaining walls not more than six feet (6') in height, or as permitted in Section 15-4-2.
8. Driveways leading to a garage or approved Parking Area.
9. Pathways and steps connecting to a City staircase or pathway.
10. Mechanical equipment (which must be screened), hot tubs, or similar Structures located at least three feet (3') from the Side Lot Line.

<sup>1</sup>Applies only to Lots with a minimum Side ~~Yard-Setback~~ of five feet (5').

**15-2.4-5 Special Requirements For Multi-Unit Dwellings**

- A. **FRONT YARD SETBACK**. The Front ~~Yard Setback~~ for any Triplex, or Multi-Unit Dwelling is twenty (20') feet. All new Front-Facing Garages shall be a minimum of twenty-five feet (25') from the Front Property Line. All Yards fronting ~~on~~ any Street are

considered Front Yards for the purposes of determining required Setbacks. See Section 15-2.4-4(D), Front Yard Exceptions.

- B. **REAR ~~YARD~~ SETBACK.** The Rear ~~yard~~ Setback for a Triplex or Multi-Unit Dwelling is ten feet (10'). See Section 15-2.4-4(F), Rear ~~Yard~~ Setback Exceptions.
- C. **SIDE ~~YARD~~ SETBACK.** The Side ~~Yard~~ Setback for any Triplex, or Multi-Unit Dwelling is ten feet (10'). See Section 15-2.4-4(H), Side ~~Yard~~ Setback Exceptions.

### 15-2.4-9 Sullivan Road Access

- B. **NEIGHBORHOOD MANDATORY ELEMENTS CRITERIA.** The Planning Commission shall review and evaluate the following criteria for all projects along Sullivan Road and Eastern Avenue:
  - 1. **UTILITY CONSIDERATIONS.** Utility extensions from Park Avenue are preferred, which provide the least disturbance to the City Park and the public as a whole.
  - 2. **ENHANCED SITE PLAN CONSIDERATIONS.** These review criteria apply to both Sullivan Road and Park Avenue Street fronts:
    - a. Variation in Front Yard and Building Setbacks to orient porches and windows onto Street fronts.
    - b. Increased Front ~~Yard~~ Setbacks.
    - c. Increased snow storage.
    - d. Increased Transferred Development Right (TDR) Open Space, and/or preservation of significant landscape elements.
    - e. Elimination of Multi-Unit or Triplex Dwellings.
    - f. Minimized Access to Sullivan Road.
    - g. Decreased Density.
  - 3. **INCORPORATION OF PEDESTRIAN AND LANDSCAPE IMPROVEMENTS ALONG PARK AVENUE, SULLIVAN ROAD, AND EASTERN AVENUE.** Plans must save, preserve, or enhance pedestrian connections and landscape elements along the Streetscape, within the Development Site, and between Park Avenue and Sullivan Road.
  - 4. **PARKING MITIGATION.** Plans that keep the Front ~~Yard~~ Setbacks clear of parking and minimize parking impacts near intensive Uses on Sullivan Road are positive elements of any Site plan.

## 15-2.5 Historic Recreation Commercial (HRC) District

### 15-2.5-3 Lot And Site Requirements

- A. **FRONT ~~YARD~~ SETBACK.** The minimum Front ~~Yard~~ Setback is ten feet (10').
- B. **FRONT YARD EXCEPTIONS.** The Front ~~Yard~~ Setback must be open and free of any Structure except:
  - 1. Fences, walls, and retaining walls not more than four feet (4') in height, or as permitted in Section 15-4-2. On Corner Lots, Fences more than three feet (3') in



height are prohibited within twenty five feet (25') of the intersection at back of curb.

2. Uncovered steps leading to the Main Building; provided the steps are not more than four feet (4') in height from Final Grade, not including any required handrail, and do not cause danger or hazard to traffic by obstructing the view of the Street or intersection.

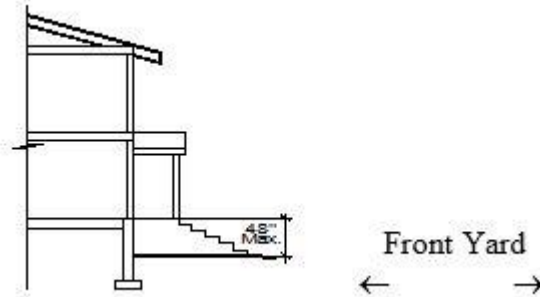

3. Decks, porches, and Bay Windows, not more than ten feet (10') wide, projecting not more than three feet (3') into the Front ~~Yard-Setback~~.
4. Roof overhangs, eaves, and cornices, projecting not more than three feet (3') into the Front ~~Yard-Setback~~.
5. Sidewalks, patios, and pathways.
6. Driveways leading to a garage or Parking Area. No portion of a Front Yard, except for approved driveways, allowed Parking Areas, patios, and sidewalks may be Hard-Surfaced or graveled.

C. **REAR YARD-SETBACK**. The minimum Rear ~~Yard-Setback~~ is ten feet (10').

D. **REAR YARD-SETBACK EXCEPTIONS**. The Rear ~~Yard-Setback~~ must be open and free of any Structure except:

1. Bay Windows not more than ten feet (10') wide projecting not more than two feet (2') into the Rear ~~Yard-Setback~~.
2. Chimneys not more than five feet (5') wide projecting not more than two feet (2') into the Rear ~~Yard-Setback~~.
3. Window wells and light wells projecting not more than four feet (4') into the Rear ~~Yard-Setback~~.
4. Roof overhangs and eaves projecting not more than two feet (2') into the Rear ~~Yard-Setback~~.
5. Window sills, belt courses, cornices, trim, exterior siding, or other ornamental features projecting not more than six inches (6") beyond the window or main Structure to which it is attached.
6. A detached Accessory Building not more than eighteen feet (18') in height, located a minimum of five feet (5') behind the front facade of the Main Building, and maintaining a minimum Rear ~~Yard-Setback~~ of one foot (1'). Such Structure must not cover over fifty percent (50%) of the Rear Yard. See the following

illustration:

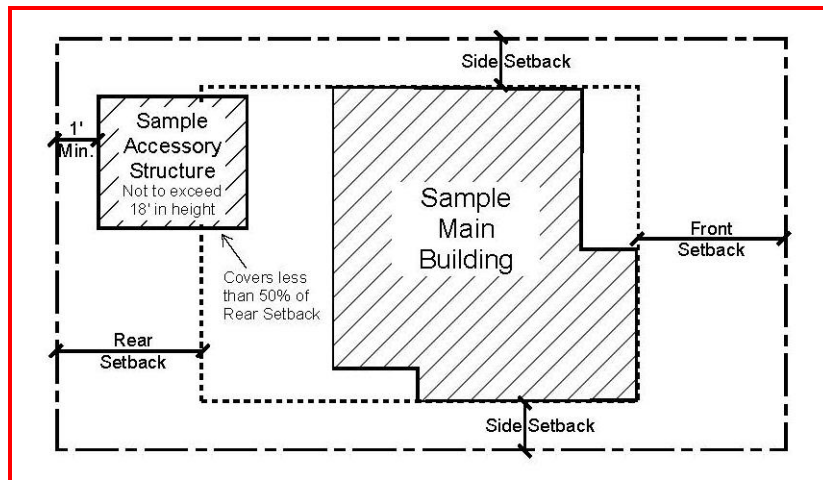
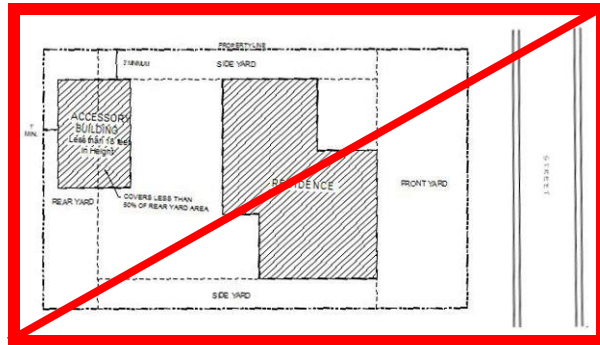

7. Hard-Surfaced Parking Areas subject to the same location requirements as a detached Accessory Building.
8. Screened mechanical equipment, hot tubs, and similar Structures located at least five feet (5') from the Rear Lot Line.
9. Fences, walls, and retaining walls not more than six feet (6') in height, or as permitted in Section 15-4-2.
10. Patios, decks, steps, pathways, and similar Structures not more than thirty inches (30") above Final Grade, located at least five feet (5') from the Rear Lot Line.

**E. SIDE YARD SETBACK.**

1. The minimum Side ~~Yard-Setback~~ is five feet (5').
2. On Corner Lots, the Side ~~Yard-Setback~~ that faces a Street is ten feet (10') for both main and accessory Structures.
3. A Side ~~Yard-Setback~~ between connected Structures is not required where Structures are designed with a common wall on a Property Line, each Structure is located on an individual Lot, the Lots are burdened with a party wall agreement in a form approved by the City Attorney and Chief Building Official, all applicable Building and Fire Code requirements are met, and the Use is an Allowed or Conditional Use in the Zoning District.
  - a. Exterior Side ~~Yards-Setbacks~~ shall be based on the minimum required Side ~~Yard-Setback~~ for each Lot; however the Planning Commission may consider increasing exterior Side ~~Yards-Setbacks~~ during Conditional Use

Permit review to mitigate potential impacts on adjacent Property. Side ~~Yard-Setback~~ exceptions continue to apply.

F. **SIDE ~~YARD-SETBACK~~ EXCEPTIONS**. The Side ~~Yard-Setback~~ must be open and free of any Structure except:

1. Bay Windows, not more than ten feet (10') wide, projecting not more than two feet (2') into the Side ~~Yard-Setback~~.
2. Chimneys not more than five feet (5') wide, projecting not more than two feet (2') into the Side ~~Yard-Setback~~.
3. Window wells and light wells projecting not more than four feet (4') into the Side ~~Yard-Setback~~.
4. Window sills, belt courses, cornices, trim, exterior siding, and other ornamental features, projecting not more than six inches (6") beyond the window or main Structure to which it is attached.
5. Roof overhangs and eaves projecting not more than two feet (2') into the Side ~~Yard-Setback~~.
6. Patios, decks, pathways, steps, and similar Structures not more than thirty inches (30") in height from Final Grade, provided there is at least a one foot (1') Setback to the Side Lot Line.
7. Fences, walls and retaining walls not more than six feet (6'), or as permitted in Section 15-4-2.
8. Driveways leading to a garage or approved Parking Area.
9. Pathways and steps connecting to a City stairway or pathway.
10. A detached Accessory Building not more than eighteen feet (18') in height, located a minimum of five feet (5') behind the front facade of the Main Building, maintaining a minimum Side ~~Yard-Setback~~ of three feet (3'). See the following illustration:

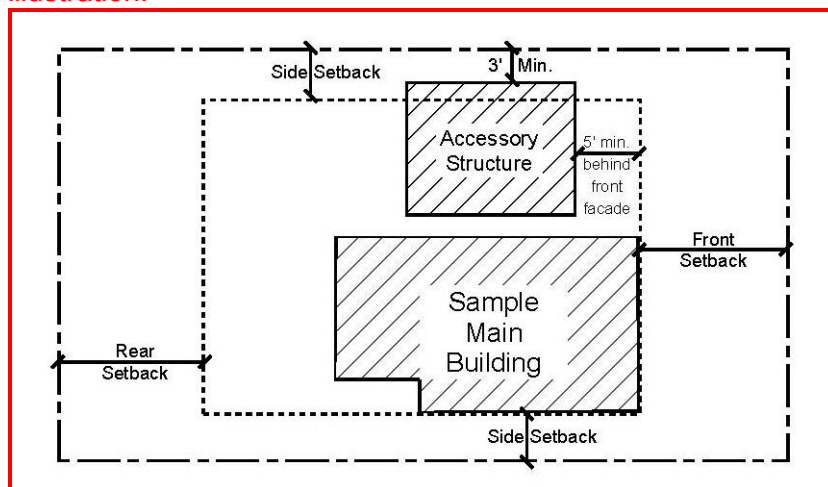

11. A covered arcade between projects provided that the highest point of the arcade is not more than fifteen feet (15') above the elevation of the walk.

**15-2.5-11 Parking Regulations**

- D. A common Parking Structure may occupy below Grade Side ~~Yards Setbacks~~ between participating Developments if the Structure maintains all Setbacks above Grade. Common Parking Structures are subject to a Conditional Use Review, Section 15-1-10.

## 15-2.6 Historic Commercial Business (HCB) District

### 15-2.6-3 Lot And Site Requirements

- B. **FRONT, REAR AND SIDE YARDS-SETBACKS.** There are no minimum required Front, Rear, or Side ~~Yard-Setback~~ dimensions in the HCB District.

### 15-2.6-5 Maximum Building Volume And Height

- B. The rear portion of the bulk plane for each Lot that does not abut Swede Alley is defined by the plane that rises vertically at the Rear ~~Yard~~-Property Line to a height of thirty feet (30') measured above the average Natural Grade and then proceeds at a forty-five degree (45°) angle toward the Front Lot Line until it intersects with a point forty-five feet (45') above the Natural Grade of the Building Site. No part of a Building shall be erected to a height greater than forty-five feet (45'), measured from Natural Grade at the Building Site. This provision must not be construed to encourage solid roofing to following the forty-five degree (45°) back plane.
- C. For Lots abutting Swede Alley, the rear portion of the bulk plane is defined by a plane that rises vertically at the Rear ~~Yard~~-Property Line to a height of twenty-four feet (24') measured above the average Natural Grade and then proceeds at a forty-five degree (45°) angle toward the Front Lot Line until it intersects with a point forty-five feet (45') above the Natural Grade. This provision must not be construed to encourage solid roofing to follow the forty-five degree (45°) back plane.

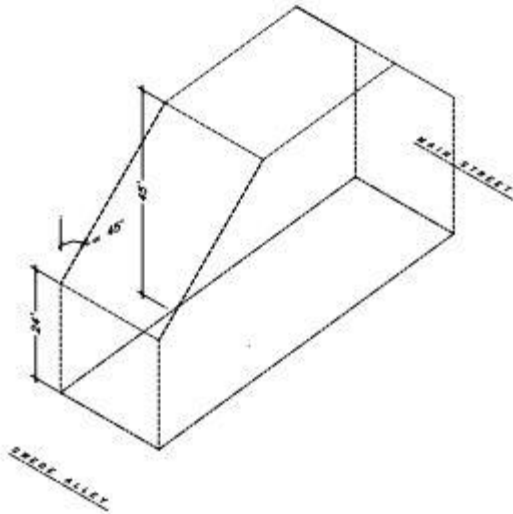

## 15-2.7 Recreation And Open Space (ROS) District

### 15-2.7-3 Lot And Site Requirements

- A. **FRONT, SIDE, AND REAR YARD-SETBACK EXCEPTIONS.** Fences, walls, stairs, paths, trails, sidewalks, patios, driveways, Ancillary Structures, approved Parking Areas, and Screened mechanical and utility equipment are allowed as exceptions in the Front, Side and Rear ~~Yards-Setbacks~~.



## **15-2.8 Protected Open Space (POS) District**

### **15-2.8-3 Lot And Use Requirements**

- A. **FRONT, SIDE, AND REAR ~~YARD SETBACK~~ EXCEPTIONS.** Fences, walls, stairs, paths, trails, sidewalks, at Grade patios, driveways, Ancillary Structures, approved Parking Areas and Screened mechanical and utility equipment are allowed in the Front, Side, and Rear ~~Yards~~ **Setbacks**.

## **15-2.9 Rural Estate (E-40) District**

### **15-2.9-3 Lot And Site Requirements**

- C. **SETBACKS.** The minimum Front, Side, and Rear ~~yards~~ **Setbacks** for all Structures are thirty feet (30').

## **15-2.10 Estate (E) District**

### **15-2.10-3 Lot And Site Requirements**

C. **REQUIRED SETBACKS.** The minimum Front, Side and Rear ~~Yard~~ **Setback** for all Structures is thirty feet (30'). The Planning Commission may vary required ~~yards~~ **Setbacks** in Subdivisions and Master Planned Developments. In no case shall the Planning Commission reduce Side ~~Yards~~ **Setbacks** to allow less than ten feet (10') between Structures.

D. **FRONT ~~YARD SETBACK~~ EXCEPTIONS.** The required Front ~~Yard~~ **Setback** must be open and free of any Structure except for the following:

3. Decks, porches, and Bay Windows, not more than ten feet (10') wide, projecting not more than five feet (5') into the Front ~~Yard~~ **Setback**.
4. Roof overhangs, eaves, and cornices projecting not more than three feet (3') into the Front ~~Yard~~ **Setback**.
6. Driveways leading to a garage or Parking Area. No portion of a Front Yard, except for patios, driveways, allowed Parking Areas, and sidewalks may be Hard-Surfaced or graveled.

E. **REAR ~~YARD SETBACK~~ EXCEPTIONS.** The required Rear ~~Yard~~ **Setback** must be open and free of any Structure except for the following:

1. Bay Windows not more than ten feet (10') ~~long wide~~, projecting not more than two feet (2') into the Rear ~~Yard~~ **Setback**.
2. Chimneys not more than five feet (5') wide projecting not more than two feet (2') into the Rear ~~Yard~~ **Setback**.
3. Window wells and light wells projecting not more than four feet (4') into the Rear ~~Yard~~ **Setback**.
4. Roof overhangs and eaves projecting not more than three feet (3') into the Rear ~~Yard~~ **Setback**.
6. Detached Accessory Buildings not more than eighteen (18') feet in height and maintaining a minimum Setback of five feet (5'). Such Structures must not cover over twenty-five percent (25%) of the Rear Yard.

**F. SIDE ~~YARD~~ SETBACK EXCEPTIONS.** The required Side ~~Yard~~ Setback must be open and free of any Structure except:

1. Bay Windows not more than ten feet (10') wide projecting not more than two feet (2') into the Side ~~Yard~~ Setback.
2. Chimneys not more than five feet (5') wide projecting not more than two feet (2') into the Side ~~Yard~~ Setback.
3. Window wells and light wells projecting not more than four feet (4') into the Side ~~Yard~~ Setback.
4. Roof overhangs and eaves projecting not more than three feet (3') into the Side ~~Yard~~ Setback.
9. Detached Accessory Building not greater than eighteen feet (18') in height located a minimum of five feet (5') behind the front facade of the Main Building and maintaining a minimum Side ~~Yard~~ Setback of five feet (5').

## **15-2.11 Single Family (SF) District**

### **15-2.11-3 Lot And Site Requirements**

~~B. **FRONT, REAR, AND SIDE YARDS.** All Development activity must comply with the following minimum Yard.~~

**C. FRONT ~~YARD~~ SETBACK.**

1. In Thaynes Canyon Subdivision 1 and 2 and Prospector Village Subdivision, the minimum Front ~~Yard~~ Setback for Main Buildings is twenty feet (20') and minimum Front ~~Yard~~ Setback for Garages is ten feet (10').
2. In Prospector Park Subdivisions 1, 2, and 3, the minimum Front ~~Yard~~ Setback is 20 feet (20'), including Garages.
3. In all other subdivisions, the minimum Front ~~Yard~~ Setback is twenty feet (20'). New Front-Facing Garages for Single Family and Duplex Dwellings must maintain a minimum of twenty five feet (25') from Front Lot Line.

**D. FRONT ~~YARD~~ SETBACK EXCEPTIONS.**

1. The Planning Commission may designate specific Single Family Lots on which the Front ~~Yard~~ Setback is ten feet (10') for the Main Building and fifteen feet (15') for a new Front Facing Garage or garage element, including any habitable **space** above the garage. This exception may be granted to:
  - a. solve Access problems with relatively steep Grades,
  - b. preserve Significant Vegetation,
  - c. eliminate or minimize cut and fill Areas,
  - d. promote Clustered Development, and
  - e. preserve Open **Space**.Lots to which this exception applies must be so designated on the Subdivision Plat at the time the plat is approved.
2. The Front ~~Yard~~ Setback must be open and free of any Structure except:
  - a. Fences, walls, and retaining walls not more than four feet (4') in height, or as permitted in Section 15-4-2. On Corner Lots, Fences more than three feet (3') in height are prohibited within twenty-five feet (25') of the intersection at back of curb.

- b. Uncovered steps leading to the Main Building provided the steps are not more than four feet (4') in height from Final Grade, not including any required handrail, and do not cause any danger or hazard to traffic by obstructing the view of a Street or intersection.
- c. Decks, porches, and Bay Windows, not more than ten feet (10') wide, projecting not more than five feet (5') into the Front ~~Yard~~ **Setback**.
- d. Roof overhangs, eaves, and cornices projecting not more than three feet (3') into the Front ~~Yard~~ **Setback**.
- e. Sidewalks, patios, and pathways.
- f. Driveways leading to a garage or Parking Area. No portion of a Front Yard, except for approved driveways and patios, allowed Parking Areas, and sidewalks may be Hard-Surfaced or graveled.
- g. Circular driveways meeting all requirements stated in Section 15-3-4.

**E. REAR ~~YARD~~ **SETBACK**.**

- 1. In Thaynes Canyon Subdivision 1 and 2 and Prospector Village Subdivision, the minimum Rear ~~Yard~~ **Setback** is 10 feet (10').
- 2. In Prospector Park Subdivisions 1, 2, and 3 the minimum Rear ~~Yard~~ **Setback** is ten feet (10').
- 3. In all other subdivisions, the minimum Rear ~~Yard~~ **Setback** is fifteen feet (15').

**F. REAR ~~YARD~~ **SETBACK** EXCEPTIONS.** The Rear ~~Yard~~ **Setback** must be open and free of any Structure except:

- 1. Bay Windows not more than ten feet (10') wide projecting not more than two feet (2') into the Rear ~~Yard~~ **Setback**.
- 2. Chimneys not more than five feet (5') wide projecting not more than two feet (2') into the Rear ~~Yard~~ **Setback**.
- 3. Window wells and light wells projecting not more than four feet (4') into the Rear ~~Yard~~ **Setback**.
- 4. Roof overhangs and eaves projecting not more than three feet (3') into the Rear ~~Yard~~ **Setback**.
- 5. Window sills, belt courses, cornices, trim, and other ornamental features projecting not more than six inches (6") beyond the window or main Structure to which it is attached.
- 6. Detached Accessory Buildings not more than eighteen feet (18') in height and maintaining a minimum Rear ~~Yard~~ **Setback** of five feet (5'). Such Structure must not cover over fifty percent (50%) of the Rear Yard. See the following illustration:

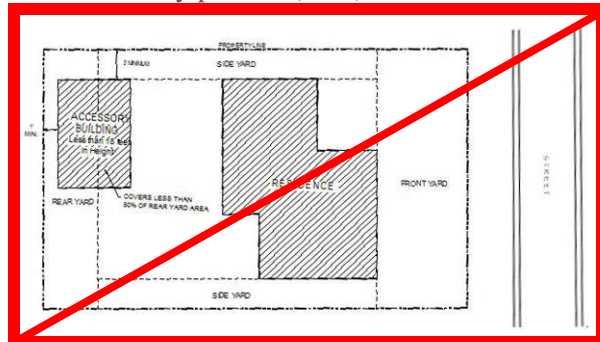

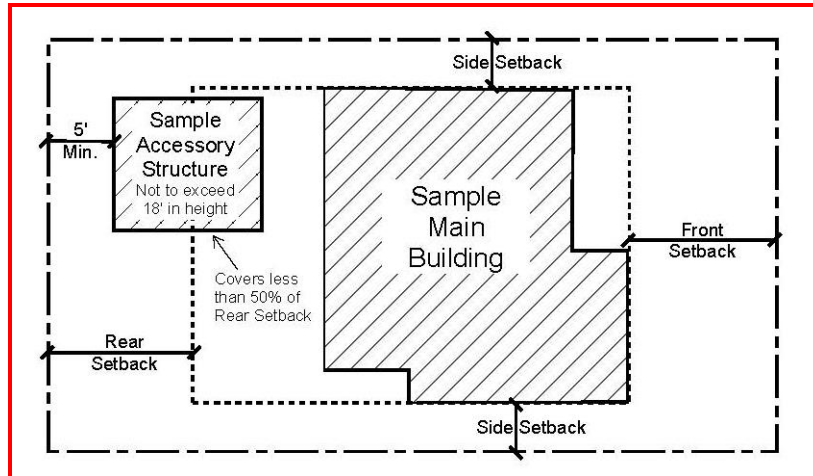

7. Hard-Surfaced Parking Areas subject to the same location requirements as detached Accessory Buildings.
8. Screened mechanical equipment, hot tubs, and similar Structures located at least five feet (5') from the Rear Lot Line.
9. Fences, walls, and retaining walls not more than six feet (6') in height, or as permitted in Section 15-4-2. Retaining walls may have multiple steps, however, each exposed face cannot exceed six feet (6') in height and the horizontal distance between the walls, front face to rear face, must be at least three feet (3') and planted with approved vegetation. The Planning Director may approve minor deviations to the height and stepping requirements based on Site specific review.<sup>1</sup>
10. Patios, decks, pathways, steps, or similar Structures not more than thirty inches (30") above Final Grade, provided it is located at least five feet (5') from the Rear Lot Line.

**G. SIDE YARD SETBACK.**

1. In Thaynes Canyon Subdivision 1 and 2 and Prospector Village Subdivision, the minimum Side **Yard Setback** is five feet (5'). On Corner Lots the minimum Side **Yard Setback** abutting a Street is ten feet (10').
2. In Prospector Park Subdivisions 1, 2, and 3 the minimum Rear **Yard Setback** is ten feet (10').
3. In all other subdivisions, the minimum Side **Yard Setback** is twelve feet (12').
4. A Side **Yard Setback** between connected Structures is not required where Structures are designed with a common wall on a Property Line, each Structure is located on an individual Lot, the Lots are burdened with a party wall agreement in a form approved by the City Attorney and Chief Building Official, all applicable Building and Fire Code requirements are met, and the Use is an Allowed or Conditional Use in the Zoning District.
  - a. Exterior Side **Yard Setbacks** shall be based on the required minimum Side **Yard Setback** for each Lot; however the Planning Commission may consider increasing exterior Side **Yard Setbacks** during Conditional Use Permit review to mitigate potential impacts on adjacent Property. Side **Yard Setbacks** exceptions continue to apply.

**H. SIDE YARD SETBACK EXCEPTIONS.** The Side **Yard Setback** must be open and free of any Structure except:



1. Bay Windows not more than ten feet (10') wide projecting not more than two feet (2') into the Side ~~Yard~~ **Setback**.
2. Chimneys not more than five feet (5') wide projecting not more than two feet (2') into the Side ~~Yard~~ **Setback**.
3. Window wells and light wells projecting not more than four feet (4') into the Side ~~Yard~~ **Setback**.
4. Roof overhangs and eaves projecting not more than three feet (3') into the Side ~~Yard~~ **Setback**.
5. Window sills, belt courses, cornices, trim, and other ornamental features projecting not more than six inches (6") beyond the window or main Structure to which it is attached.
6. Patios, decks, pathways, steps, and similar Structures not more than thirty inches (30") in height above Final Grade, provided there is at least one foot (1') Setback to the Side Lot Line.
7. Fences, walls, and retaining walls not more than six feet (6') in height, or as permitted in Sections 15-4-2. Retaining walls may have multiple steps, however, each exposed face cannot exceed six feet (6') in height and the horizontal distance between the walls, front face to rear face, must be at least three feet (3') and planted with approved vegetation. The Planning Director may approve minor deviations to the height and stepping requirements based on Site specific review.<sup>2</sup>
8. Driveways leading to an approved garage or Parking Area maintaining a three foot (3') landscaped Setback to the Side Lot Line. A paved turn out Area, to aid in backing a vehicle out of a garage or Parking Area, is allowed but may not be used for parking, and must maintain a one foot (1') landscaped Setback to the Side Lot Line.
9. Detached Accessory Buildings not more than eighteen feet (18') in height, located a minimum of five feet (5') behind the front facade of the Main Building, and maintaining a minimum Side ~~Yard~~ **Setback** of five feet (5').
10. Screened mechanical equipment, hot tubs, and similar Structures located a minimum of five feet (5') from the Side Lot Line.

## 15-2.12 Residential (R-1) District

### 15-2.12-3 Lot And Site Requirements

#### B. FRONT ~~YARD~~ **SETBACK**.

1. The minimum Front ~~Yard~~ **Setback** is fifteen feet (15').
2. New Front Facing Garages for Single Family and Duplex Dwellings must be at least ~~than~~ twenty feet (20') from the Front Property Line.
3. Parking Spaces are allowed within the required Front ~~Yard~~ **Setback**, but not within five feet (5') of Side Lot Lines.

#### C. FRONT ~~YARD~~ **SETBACK EXCEPTIONS**. The Front ~~Yard~~ **Setback** must be open and free of any Structure except:

1. Fences, walls, and retaining walls not more than four feet (4') in height, or as permitted in Section 15-4-2. On Corner Lots, Fences more than three feet (3') in height are prohibited within twenty-five feet (25') of the intersection at back of curb.

2. Uncovered steps leading to the Main Building provided the steps are not more than four feet (4') in height from Final Grade, not including any required handrails, and do not cause any danger or hazard to traffic by obstructing the view of a Street or intersection.
3. Decks, porches, and Bay Windows not more than ten feet (10') wide, projecting not more than five feet (5') into the Front ~~Yard~~ **Setback**.
4. Roof overhangs, eaves, and cornices projecting not more than two feet (2') into the Front ~~Yard~~ **Setback**.
5. Sidewalks, patios, and pathways.
6. Driveways leading to a garage or Parking Area. No portion of a Front Yard, except for approved driveways, allowed Parking Areas, patios, and sidewalks may be Hard-Surfaced or graveled.
7. Circular driveways meeting all requirements stated in Section 15-3-4 herein.

D. **REAR ~~YARD~~ **SETBACK****. The minimum Rear ~~Yard~~ **Setback** is ten feet (10').

E. **REAR ~~YARD~~ **SETBACK** EXCEPTIONS**. The Rear ~~Yard~~ **Setback** must be open and free of any Structure except:

1. Bay Windows not more than ten feet (10') wide, projecting not more than two feet (2') into the Rear ~~Yard~~ **Setback**.
2. Chimneys not more than five feet (5') wide, projecting not more than two feet (2') into the Rear ~~Yard~~ **Setback**.
3. Window wells and light wells, projecting not more than four feet (4') into the Rear ~~Yard~~ **Setback**.
4. Roof overhangs and eaves projecting not more than two feet (2') into the Rear ~~Yard~~ **Setback**.
5. Window sills, belt courses, cornices, trim, and other ornamental features projecting not more than six inches (6") beyond the window or Structure to which it is attached.
6. Detached Accessory Buildings, not more than eighteen feet (18') in height, located a minimum of five feet (5') behind the front façade of the Main Building and maintaining a minimum Rear ~~Yard~~ **Setback** of five feet (5'). Such Structure must not cover over fifty percent (50%) of the Rear Yard. See the following illustration:

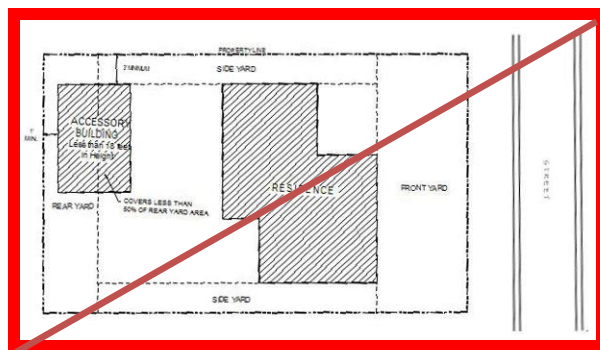

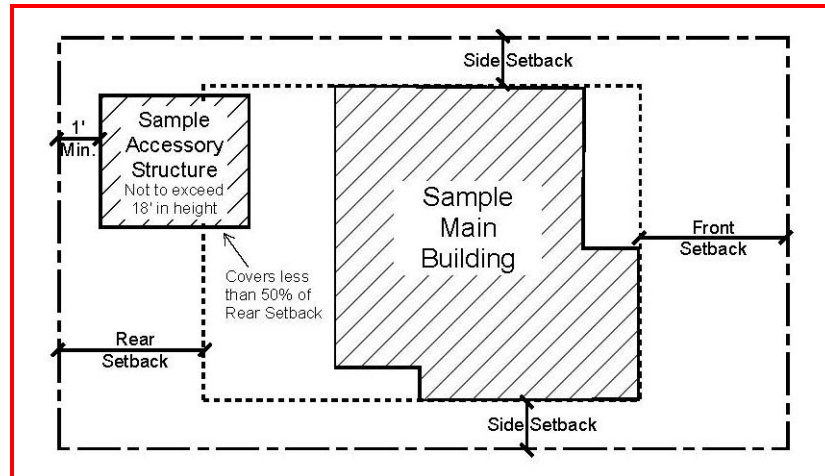

Screened

mechanical equipment, hot tubs, and similar Structures located at least five feet (5') from the Rear Lot Line.

7. Fences, walls, and retaining walls not more than six feet (6') in height, or as permitted in Section 15-4-2. Retaining walls may have multiple steps; however, each exposed face cannot exceed six feet (6') in height and the horizontal distance between the walls, front face to rear face, must be at least three feet (3') and planted with approved vegetation. The Planning Director may approve minor deviations to the height and stepping requirements based on Site specific review.<sup>1</sup>
8. Patios, decks, pathways, steps and similar Structures not more than thirty inches (30") above Final Grade, located at least five feet (5') from the Rear Lot Line.

**F. SIDE ~~YARD~~ SETBACK.**

1. The minimum Side ~~Yard~~ Setback is five feet (5').
2. A Side ~~Yard~~ Setback between connected Structures is not required where Structures are designed with a common wall on a Property Line, each Structure is located on an individual Lot, the Lots are burdened with a party wall agreement in a form approved by the City Attorney and Chief Building Official, all applicable Building and Fire Code requirements are met, and the Use is an Allowed or Conditional Use in the Zoning District.
  - a. Exterior Side ~~Yard~~ Setbacks shall be based on the required minimum Side ~~Yard~~ Setback for each Lot; however the Planning Commission may consider increasing exterior Side ~~Yard~~ Setbacks during Conditional Use Permit review to mitigate potential impacts on adjacent Property. Side ~~Yard~~ Setback exceptions continue to apply.
3. The minimum Side ~~Yard~~ Setback for a Detached Accessory Building not greater than eighteen feet (18') in height, located at least five feet (5') behind the front facade of the Main Building is one foot (1'), except when an opening is proposed on an exterior wall adjacent to the Property Line, at which time the minimum Side ~~Yard~~ Setback must be

three feet (3'). See the following illustration:

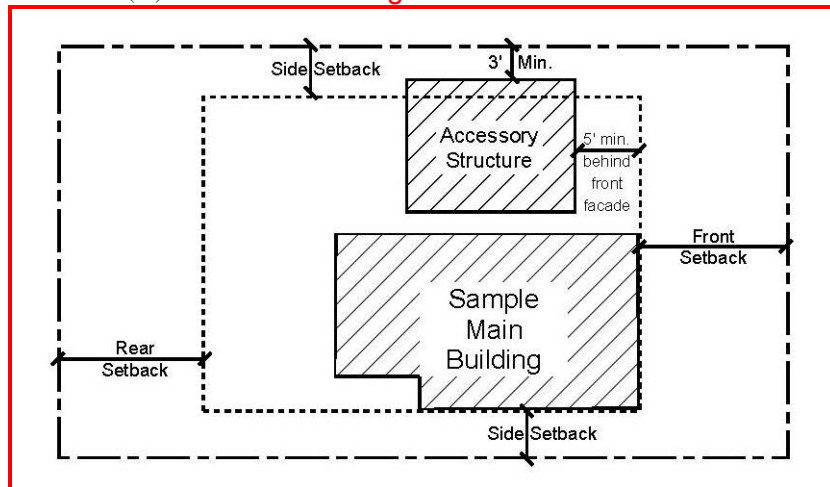

4. On a Corner Lot, the **minimum** Side Yard that faces a Street or platted Right-of-Way is considered a Front Yard, and a ten feet foot (10') Setback is required for both the Main and Accessory Buildings.

- G. **SIDE YARD SETBACK EXCEPTIONS.** The Side ~~Yard~~ Setback must be open and free of any Structure except:
1. Bay Windows not more than ten feet (10') wide, projecting not more than two feet (2') into the Side ~~Yard~~ Setback.
  2. Chimneys not more than five feet (5') wide projecting not more than two feet (2') into the Side ~~Yard~~ Setback.
  3. Window wells and light wells projecting not more than four feet (4') into the Side ~~Yard~~ Setback.
  4. Roof overhangs and eaves projecting not more than two feet (2') into the Side ~~Yard~~ Setback.

#### 15-2.12-4 Special Setback Requirements For Conditional Uses

Conditional Uses in the R-1 District must maintain the following Setbacks:

- A. **SIDE YARD SETBACK.** The minimum Side ~~Yard~~ Setback is ten feet (10').
- B. **FRONT YARD SETBACK.** The minimum Front ~~Yard~~ Setback is twenty feet (20'). All yards of Structures fronting on any Streets must be considered Front Yards for the purposes of determining required Setbacks. Garages must be a minimum of five feet (5') behind the front facade of the Main Building or underground.
- C. **REAR YARD SETBACK.** The minimum Rear ~~Yard~~ Setback is ten feet (10').
- D. Front, Rear, and Side ~~Yard~~ Setback Exceptions as stated in Section 15-2.12-3 apply.

### 15-2.13 Residential Development (RD) District

#### 15-2.13-3 Lot And Site Requirements

- B. **FRONT YARD SETBACK.** The minimum Front ~~Yard~~ Setback is twenty feet (20'). New Front Facing Garages for Single-Family and Duplex Dwellings must be at least twenty-five feet (25')



from the Front Lot Line.

**C. FRONT ~~YARD-SETBACK~~ EXCEPTIONS.**

1. Within any subdivision, the Planning Commission may designate specific Single Family and Duplex Dwelling Lots on which the Front ~~Yard~~ Setback is ten feet (10') for the Main Building and fifteen feet (15') for the new Front Facing Garage or garage element, including any Habitable Space above the garage. This exception may be granted to:
  - a. solve Access problems to Lots with relatively steep Grades,
  - b. preserve Significant Vegetation,
  - c. eliminate or minimize cut and fill Areas,
  - d. promote Clustered Development, and
  - e. preserve Open Space.

Lots to which this exception applies must be so designated on the Subdivision Plat at the time the plat is approved.

2. **EXCEPTIONS FOR STRUCTURES.** The Front ~~Yard~~ Setback must be open and free of any Structure except:
  - a. Fences, walls, and retaining walls not more than four feet (4') in height, or as permitted in Section 15-4-2. On Corner Lots Fences more than three feet (3') in height are prohibited within twenty-five feet (25') of the intersection at back of curb.
  - b. Uncovered steps leading to the Main Building, provided the steps are not more than four feet (4') in height from Final Grade, not including any required handrail, and do not cause any danger or hazard to traffic by obstructing the view of a Street or intersection.
  - c. Decks, porches, and Bay Windows, not more than ten feet (10') wide, projecting not more than five feet (5') into the Front ~~Yard~~ Setback.
  - d. Roof overhangs, eaves, and cornices projecting not more than three feet (3') into the Front ~~Yard~~ Setback.
  - e. Sidewalks, patios, and pathways.
  - f. Driveways leading to a garage or Parking Area. No portion of a Front Yard, except for approved driveways, patios, allowed Parking Areas, and sidewalks may be Hard-Surfaced or graveled.
  - g. Circular driveways, meeting all requirements stated in Section 15-3-4 herein.

**D. REAR ~~YARD-SETBACK~~.** The minimum Rear ~~Yard~~ Setback is fifteen feet (15') for Main Buildings and ten feet (10') for Accessory Buildings and detached garages.

**E. REAR ~~YARD-SETBACK~~ EXCEPTIONS.** The Rear ~~Yard~~ Setback must be open and free of any Structure except:

1. Bay Windows not more than ten feet (10') wide projecting not more than two feet (2') into the Rear ~~Yard~~ Setback.
2. Chimneys not more than five feet (5') wide projecting not more than two feet (2') into the Rear ~~Yard~~ Setback.
3. Window wells and light wells projecting not more than four feet (4') into the Rear ~~Yard~~ Setback.

4. Roof overhangs and eaves projecting not more than three feet (3') into the Rear ~~Yard~~ **Setback**.
5. Window sills, belt courses, cornices, trim, and other ornamental features projecting not more than six inches (6") beyond the window or main Structure to which it is attached.
6. Detached Accessory Buildings not more than eighteen feet (18') in height and maintaining a minimum Rear ~~Yard~~ **Setback** of five feet (5'). Such Structures must not cover over fifty percent (50%) of the Rear Yard. See the following illustration:

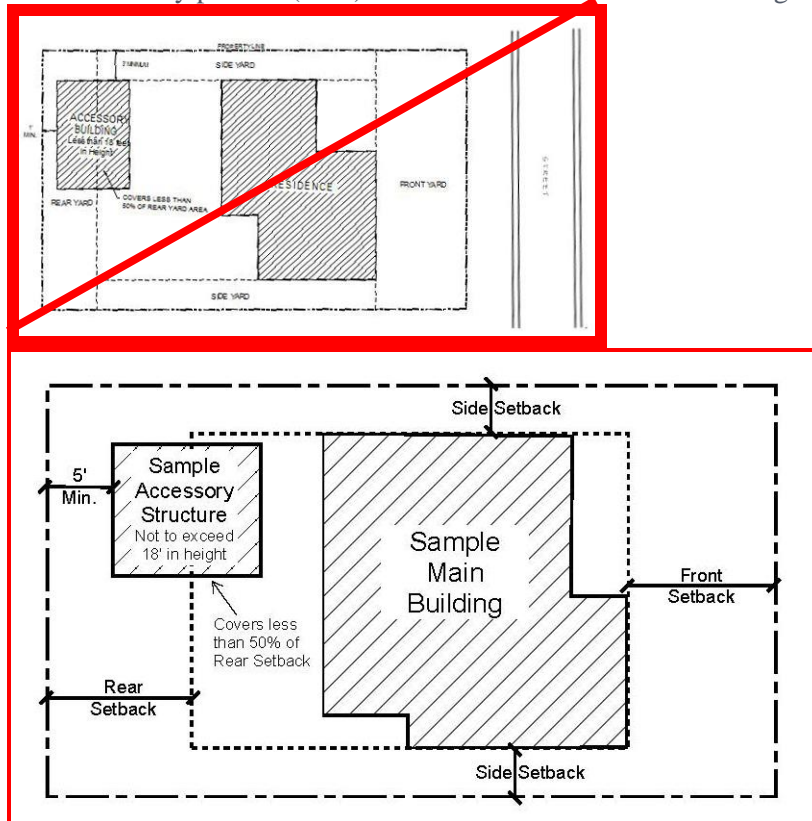

7. Hard-Surfaced Parking Areas subject to the same location requirements as detached Accessory Buildings.
8. Screened mechanical equipment, hot tubs, and similar Structures located at least five feet (5') from the Rear Lot Line.
9. Fences, walls, and retaining walls not more than six feet (6') in height. A retaining wall may have multiple steps, however, each exposed face cannot exceed six feet (6') in height and the horizontal distance between the walls, front face to rear face, must be at least three feet (3') and planted with approved vegetation. The Planning Director may approve minor deviations to the height and stepping requirements based on Site specific review.<sup>1</sup>
10. Patios, decks, pathways, steps, and similar Structures not more than thirty inches (30") above Final Grade, provided it is located at least five feet (5') from the Rear Lot Line.

**F. SIDE ~~YARD~~ **SETBACK.****

1. The minimum Side ~~Yard~~ **Setback** is twelve feet (12').
2. A Side ~~Yard~~ **Setback** between connected Structures is not required where Structures are designed with a common wall on a Property Line, each Structure is located on an individual Lot, the Lots are burdened with a party wall agreement in a form approved by

the City Attorney and Chief Building Official, all applicable Building and Fire Code requirements are met, and the Use is an Allowed or Conditional Use in the Zoning District.

- a. Exterior Side ~~Yard~~ **Setbacks** shall be based on the required minimum Side ~~Yard~~ **Setback** for each Lot; however the Planning Commission may consider increasing exterior Side ~~Yard~~ **Setbacks** during Conditional Use Permit review to mitigate potential impacts on adjacent Property. Side ~~Yard~~ **Setback** exceptions continue to apply.

**G. SIDE ~~YARD-SETBACK~~ EXCEPTIONS.** The Side ~~Yard~~ **Setback** must be open and free of any Structure except:

1. Bay Windows not more than ten feet (10') wide, projecting not more than two feet (2') into the Side ~~Yard~~ **Setback**.
2. Chimneys not more than five feet (5') wide, projecting not more than two feet (2') into the Side ~~Yard~~ **Setback**.
3. Window wells and light wells projecting not more than four feet (4') into the Side ~~Yard~~ **Setback**.
4. Roof overhangs and eaves projecting not more than three feet (3') into the Side ~~Yard~~ **Setback**.
5. Window sills, belt courses, cornices, trim, and other ornamental features projecting not more than six inches (6") beyond the window or main Structure to which it is attached.
6. Patios, decks, pathways, steps, and similar Structures not more than thirty inches (30") in height above Final Grade, provided there is at least one foot (1') Setback to the Side Lot Line.
7. Fences, walls, and retaining walls not more than six feet (6') in height, or as permitted in Section 15-4-2. Retaining walls may have multiple steps; however, each exposed face cannot exceed six feet (6') in height and the horizontal distance between the walls, front face to rear face, must be at least three feet (3') and planted with approved vegetation. The Planning Director may approve minor deviations to the height and stepping requirements based on Site specific review.<sup>2</sup>
8. Driveways leading to an approved garage or Parking Area, maintaining a three foot (3') landscaped Setback to the Side Lot Line.
9. Detached Accessory Buildings not more than eighteen feet (18') in height, located a minimum of five feet (5') behind the front facade of the Main Building and maintaining a minimum Side ~~Yard~~ **Setback** of five feet (5').
10. Screened mechanical equipment, hot tubs, and similar Structures located a minimum of five feet (5') from the Side Lot Line.

**H. OTHER EXCEPTIONS.** The Planning Commission may vary Side ~~Yard~~ **Setbacks** in Subdivisions and Master Planned Developments. In no case shall the Planning Commission reduce Side ~~Yard~~ **Setbacks** to less than ten feet (10') between Structures, except as provided for in Section 15-2.13-3(F(2)).

#### **15-2.13-4 Building Height**

**B. OTHER HEIGHT EXCEPTIONS.** The Planning Commission may designate and condition a recorded Subdivision Plat to restrict Building Height to less than twelve feet (12') above Natural

Grade for uphill Lots between the ten foot (10') Setback allowed for garages, Section 15-2.13-3(C) (1) Front ~~Yard~~ **Setback** Exceptions, and the normal twenty-five foot (25') Setback.

## **15-2.14 Residential Development-Medium Density (RDM) District**

### **15-2.14-3 Lot And Site Requirements**

- C. **FRONT ~~YARD-SETBACK~~**. The minimum Front ~~Yard~~ **Setback** is twenty feet (20'). New Front Facing Garages for Single Family and Duplex Dwellings must be at least twenty five feet (25') from the Front Lot Line. Open Parking Spaces may be allowed within the required Front ~~Yard~~ **Setbacks**, but not within five feet (5') of the Side Lot Lines.
- D. **FRONT ~~YARD-SETBACK~~ EXCEPTIONS**. The Front ~~Yard~~ **Setback** must be open and free of any Structure except:
1. Fences, walls, and retaining walls not more than four feet (4') in height, or as permitted in Section 15-4-2. On Corner Lots, Fences more than three feet (3') in height are prohibited within twenty five feet (25') of the intersection at back of curb.
  2. Uncovered steps leading to the Main Building, provided the steps are not more than four feet (4') in height from Final Grade, not including any required hand rails, and do not cause any danger or hazard to traffic by obstructing the view of a Street or intersection.
  3. Decks, porches, and Bay Windows not more than ten feet (10') wide, projecting not more than five feet (5') into the Front ~~Yard~~ **Setback**.
  4. Roof overhangs, eaves, and cornices projecting not more than three feet (3') into the Front ~~Yard~~ **Setback**.
  5. Sidewalks, patios, and pathways.
  6. Driveways leading to a garage or Parking Area. No portion of a Front Yard, except for patios, approved driveways, allowed Parking Areas, and sidewalks may be Hard Surfaced or graveled.
  7. Circular driveways meeting all requirements stated in Section 15 3 4 herein.
- E. **REAR ~~YARD-SETBACK~~**. The minimum Rear ~~Yard~~ **Setback** is ten feet (10'). On Corner Lots that ~~back up on~~ the Side ~~Yard~~ **Setback** of another Lot, the minimum Rear ~~Yard~~ **Setback** is ten feet (10').
- F. **REAR ~~YARD-SETBACK~~ EXCEPTIONS**. The Rear ~~Yard~~ **Setback** must be open and free of any Structure except:
1. Bay Windows not more than ten feet (10') wide, projecting not more than two feet (2') into the Rear ~~Yard~~ **Setback**.
  2. Chimneys not more than five feet (5') wide, projecting not more than two feet (2') into the Rear ~~Yard~~ **Setback**.
  3. Window wells and light wells projecting not more than four feet (4') into the Rear ~~Yard~~ **Setback**.
  4. Roof overhangs and eaves projecting not more than three feet (3') into the Rear ~~Yard~~ **Setback**.
  5. Window sills, belt courses, cornices, trim, and other ornamental features projecting not more than six inches (6") into the Rear ~~Yard~~ **Setback**.
  6. Detached Accessory Buildings not more than eighteen (18') feet in height, located a minimum of five feet (5') behind the front facade of the Main Building, and maintaining a



minimum Setback of five feet (5'). Such Structure must not cover more than fifty percent (50%) of the Rear Yard. See the following illustration:

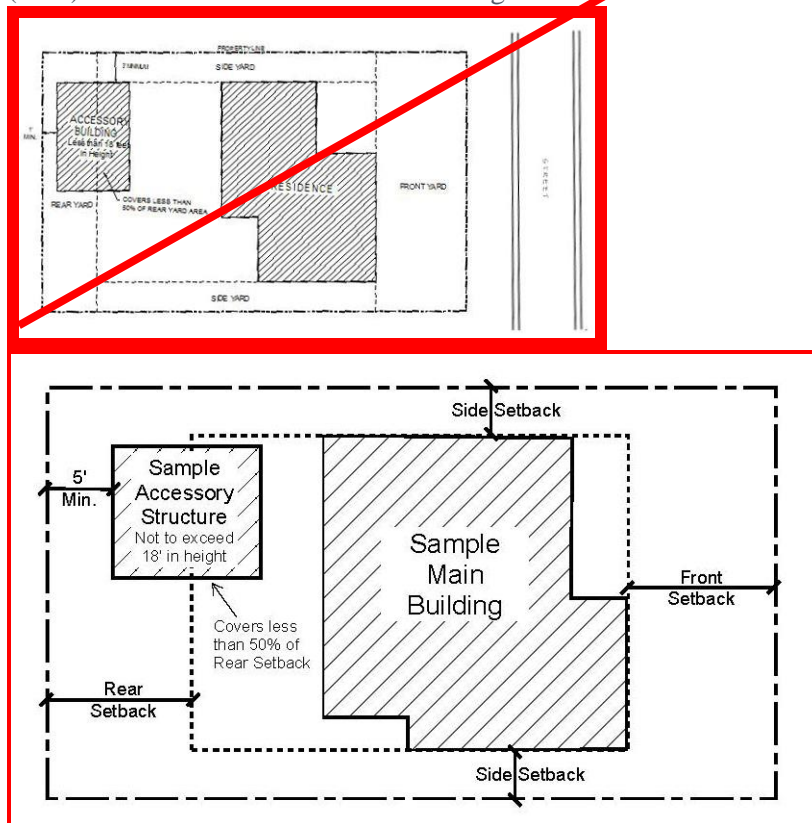

7. Hard-Surfaced Parking Areas subject to the same location requirements as a detached Accessory Building.
8. Screened mechanical equipment, hot tubs, and similar Structures located at least five feet (5') from the Rear lot Line.
9. Fences, walls, and retaining walls not more than six feet (6') in height, or as permitted in Section 15-4-2. Retaining walls may have multiple steps; however, each exposed face cannot exceed six feet (6') in height and the horizontal distance between walls, front face to rear face, must be at least three feet (3') and planted with approved vegetation. The Community Development Director may approve minor deviations to the height and stepping requirements based on Site specific review.<sup>1</sup>
10. Patios, decks, pathways, steps, and similar Structures not more than thirty inches (30") above Final Grade, provided it is located at least five feet (5') from the Rear Lot Line.

**G. SIDE YARD SETBACK.**

1. The minimum Side ~~Yard~~ **Setback** for any Structure is ten feet (10').
2. A Side ~~Yard~~ **Setback** between connected Structures is not required where Structures are designed with a common wall on a Property Line, each Structure is located on an individual Lot, the Lots are burdened with a party wall agreement in a form approved by the City Attorney and Chief Building Official, all applicable Building and Fire Code requirements are met, and the Use is an Allowed or Conditional Use in the Zoning District.

- a. Exterior Side ~~Yards Setbacks~~ shall be based on the required minimum Side ~~Yard Setback~~ for each Lot; however the Planning Commission may consider increasing exterior Side ~~Yards Setbacks~~ during Conditional Use Permit review to mitigate potential impacts on adjacent Property. Side ~~Yard Setback~~ exceptions continue to apply.
  3. On Corner Lots, the Side Yard that faces a Street or platted Right-of-Way is considered a Front Yard ~~may not have a Side Yard that is less than~~ and the minimum Setback is fifteen feet (15').
- H. **SIDE YARD-SETBACK EXCEPTIONS.** The Side ~~Yard Setback~~ must be open and free of any Structure except:
1. Bay Windows not more than ten feet (10') wide, projecting not more than two feet (2') into the Side ~~Yard Setback~~.
  2. Chimneys not more than five feet (5') wide, projecting not more than two feet (2') into the Side ~~Yard Setback~~.
  3. Window wells and light wells projecting not more than four feet (4') into the Side ~~Yard Setback~~.
  4. Roof overhangs and eaves projecting not more than three feet (3') into the Side ~~Yard Setback~~.
  5. Window sills, belt courses, cornices, trim, and other ornamental features projecting not more than six inches (6'') beyond the window or Structure to which it is attached.
  6. Patios, decks, pathways, steps, and similar Structures not more than thirty inches (30'') in height above Final Grade, located at least a minimum of one foot (1') from the Side Lot Line.
  7. Fences, walls, and retaining walls not more than six feet (6') in height, or as permitted in Section 15-4-2. A retaining wall may have multiple steps, however, each exposed face cannot exceed six feet (6') in height and the horizontal distance between the walls, front face to rear face, must be at least three feet (3') and planted with approved vegetation. The Planning Director may approve minor deviations to the height and stepping requirements based on Site specific review.<sup>1</sup>
  8. Driveways leading to a garage or approved Parking Area, maintaining a three foot (3') landscaped Setback to the Side Lot Line.
  9. Detached Accessory Buildings not more than eighteen feet (18') in height, located a minimum of five feet (5') behind the front façade of the Main Building and maintaining a minimum Side ~~Yard~~ Setback of five feet (5').
  10. Screened mechanical equipment, hot tubs, and similar Structures located a minimum of five feet (5') from the Side Lot Line.
- I. **OTHER EXCEPTIONS.** The Planning Commission may vary Front, Rear and Side ~~Yards Setbacks~~ in Subdivisions and Master Planned Developments. In no case may the Planning Commission reduce Side ~~Yards Setbacks~~ to less than ten feet (10') between Structures, except as provided for in LMC Section 15-2.14-3(G) herein.

## **15-2.15 Residential- Medium Density (RM) District**

### **15-2.15-3 Lot And Site Requirements**

C. **FRONT YARD-SETBACK.**

1. The minimum Front ~~Yard~~ **Setback** for all Single Family, Duplex Dwellings, and Accessory Buildings is fifteen feet (15'). See 15-2.13-3(C)(3) for exception for Lots with a depth of seventy-five feet (75') or less.
2. New Front Facing Garages for Single-Family and Duplex Dwellings must be at least twenty feet (20') from the Front Lot Line.
3. The minimum Front ~~Yard~~ **Setback** for Lots seventy-five feet (75') deep or less is ten feet (10').
4. See Section 15-2.15-4 for special requirements for Tri-Plex and Multi-Unit Dwellings.

D. **FRONT YARD-SETBACK EXCEPTIONS.** The Front ~~Yard~~ **Setback** must be open and free of any Structure except:

1. Fences, walls, and retaining walls not more than four feet (4') in height, or as permitted in Section 15-4-2. On Corner Lots, Fences more than three feet (3') in height are prohibited within twenty-five feet (25') of the intersection at back of curb.
2. Uncovered steps leading to the Main Building, provided, the steps are not more than four feet (4') in height from Final Grade, not including any required handrails, and do not cause any danger or hazard to traffic by obstructing the view of a Street or intersection.
3. Decks, porches, and Bay Windows not more than ten feet (10') wide, projecting not more than five feet (5') into the Front ~~Yard~~ **Setback.**
4. Roof overhangs, eaves, and cornices projecting not more than three feet (3') into the Front ~~Yard~~ **Setback.**
5. Sidewalks, patios, and pathways.
6. Driveways leading to a garage or approved Parking Area. No portion of a Front Yard, except for approved driveways, patios, allowed Parking Areas, and sidewalks, may be Hard-Surfaced or graveled.
7. Circular driveways meeting all requirements stated in Section 15-3-4 herein.

E. **REAR YARD-SETBACK.**

1. The minimum Rear ~~Yard~~ **Setback** for Single Family and Duplex Dwellings is ten feet (10').
2. See Section 15-2.15-4 special requirements for Multi-Unit Dwellings.

F. **REAR YARD-SETBACK EXCEPTIONS.** The Rear ~~Yard~~ **Setback** must be open and free of any Structure except:

1. Bay Windows not more than ten feet (10') wide, projecting not more than two feet (2') into the Rear ~~Yard~~ **Setback.**
2. Chimneys not more than five feet (5') wide, projecting not more than two feet (2') into the Rear ~~Yard~~ **Setback.**
3. Window wells and light wells projecting not more than four feet (4') into the Rear ~~Yard~~ **Setback.**
4. Roof overhangs and eaves projecting not more than three feet (3') into the Rear ~~Yard~~ **Setback.**
5. Window sills, belt courses, cornices, trim, and other ornamental features projecting not more than six inches (6") beyond the window or main Structure to which it is attached.

6. Detached Accessory Buildings not more than eighteen feet (18') in height and maintaining a minimum Rear ~~Yard~~ Setback of five feet (5'). Such Structures must not cover over fifty percent (50%) of the Rear Yard. See the following illustration:

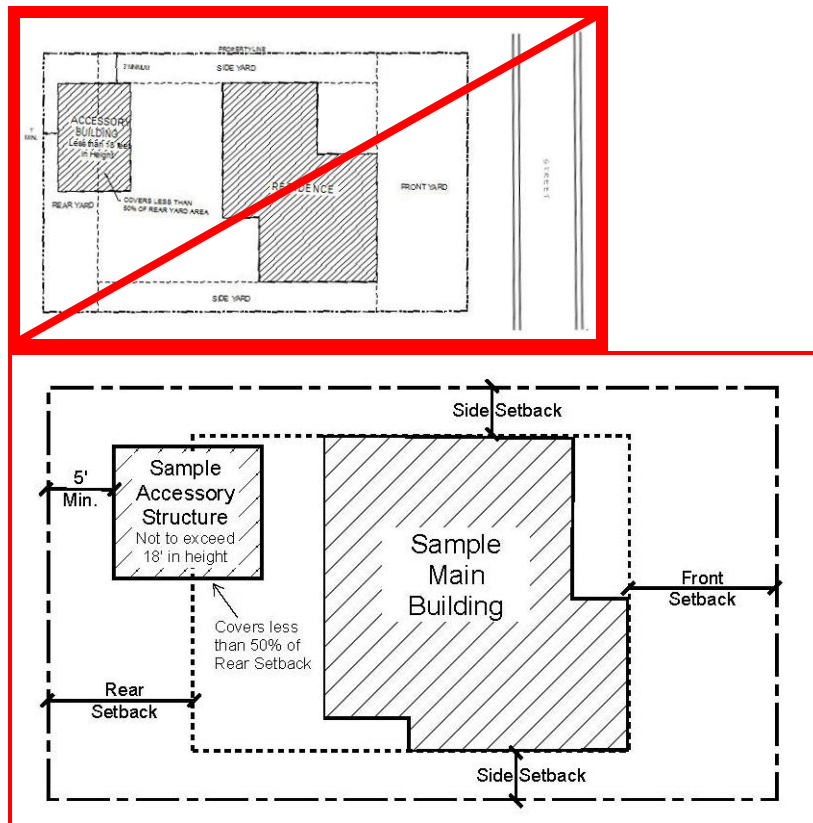

7. Hard-Surfaced Parking Areas subject to the same location requirements as a detached Accessory Building.
8. Screened mechanical equipment, hot tubs, and similar Structures located at least five feet (5') from the Rear Lot Line.
9. Fences, walls, and retaining walls not more than six feet (6') in height, or as permitted in Section 15-4-2. Retaining walls may have multiple steps, however, each exposed face cannot exceed six feet (6') in height and the horizontal distance between the walls, front face to rear face, must be at least three feet (3') and planted with approved vegetation. The Planning Director may approve minor deviations to the height and stepping requirements based on Site specific review.<sup>1</sup>
10. Patios, decks, pathways, steps, or similar Structures not more than thirty inches (30") above Final Grade, located at least five feet (5') from the Rear Lot Line.

**G. SIDE YARD SETBACK.**

1. The minimum Side ~~Yard~~ Setback for any Single Family, Duplex Dwelling or Accessory Building is five feet (5').
2. A Side ~~Yard~~ Setback between connected Structures is not required where Structures are designed with a common wall on a Property Line, each Structure is located on an individual Lot, the Lots are burdened with a party wall agreement in a form approved by the City Attorney and Chief Building Official, all applicable Building and Fire Code



requirements are met, and the Use is an Allowed or Conditional Use in the Zoning District.

- a. Exterior Side **Yard Setback** s shall be based on the required minimum Side **Yard Setback** for each Lot; however the Planning Commission may consider increasing exterior Side **Yard Setback** s during Conditional Use Permit review to mitigate potential impacts on adjacent Property. Side **Yard Setback** exceptions continue to apply.
3. The minimum Side **Yard Setback** for a detached Accessory Building not greater than eighteen feet (18') in height, located at least five feet (5') behind the front facade of the Main Building is three feet (3'). **See the following illustration:**

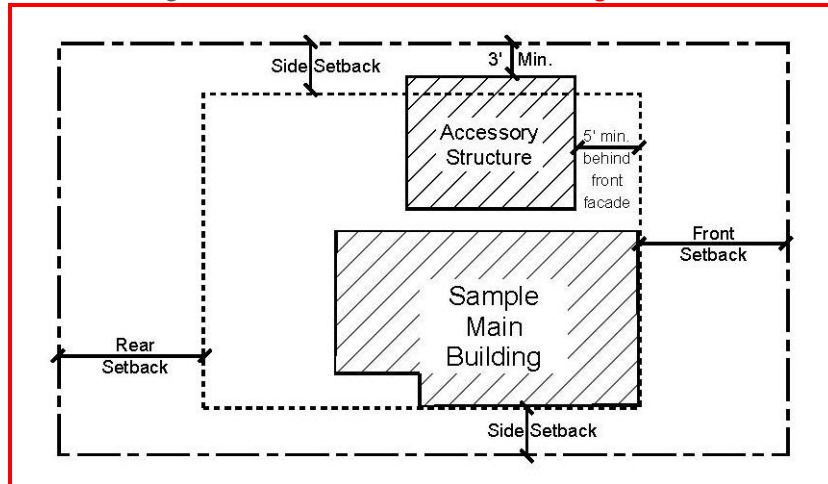

4. On Corner Lots, the Side Yard that faces a Street or platted Right-of-Way is considered a Front Yard, and the minimum Setback is ten feet (10') for both Main and Accessory Buildings.
5. See Section 15-2.15-4 Special Requirements for Multi-Unit Dwellings.

H. **SIDE YARD-SETBACK EXCEPTIONS.** The Side **Yard Setback** must be open and free of any Structure except:

1. Bay windows not more than ten feet (10') wide, projecting not more than two feet (2') into the Side **Yard Setback**.
2. Chimneys not more than five feet (5') wide, projecting not more than two feet (2') into the Side **Yard Setback**.
3. Window wells and light wells projecting not more than four feet (4') into the Side **Yard Setback**.
4. Roof overhangs and eaves projecting not more than three feet (3') into the Side **Yard Setback**.
5. Window sills, belt courses, cornices, trim, and other ornamental features projecting not more than six inches (6") beyond the window or main Structure to which it is attached.
6. Patios, decks, pathways, steps, and similar Structures not more than thirty inches (30") in height above Final Grade, provided there is at least a one foot (1') Setback to the Side Lot Line.
7. Fences, walls, and retaining walls not more than six feet (6') in height, or as permitted in Section 15-4-2. Retaining walls may have multiple steps, however each exposed face cannot exceed six feet (6') in height and the horizontal distance between the walls, front face to rear face, must be at least three feet (3') and planted with approved vegetation.

The Planning Director may approve minor deviations to the height and stepping requirements based on Site specific review.<sup>1</sup>

8. Driveways leading to an approved garage or Parking Area maintaining a three foot (3') landscaped Setback to the Side Lot Line.
9. Paths, patios, and steps connecting to a City stairway or path.
10. Screened mechanical equipment, hot tubs, and similar Structures located a minimum of five feet (5') from the Side Lot Line.

#### **15-2.15-4 Special Requirements For Multi-Unit Dwellings**

- A. **FRONT YARD-SETBACK.** The Front ~~Yard~~ **Setback** for any Triplex, or Multi-Unit Dwelling is twenty feet (20'). All new Front Facing Garages shall be a minimum of twenty-five feet (25') from the Front Property Line. All Yards fronting ~~on~~ any Street are considered Front Yards for the purposes of determining Setbacks. See Front ~~Yard~~ **Setback** Exceptions, Section 15-2.15-3(D).
- B. **REAR YARD-SETBACK.** The Rear ~~Yard~~ **Setback** for a Triplex, or Multi-Unit Dwelling is fifteen feet (15'). See Rear ~~Yard~~ **Setback** Exceptions, Section 15-2.15-3(F).
- C. **SIDE YARD-SETBACK.** The minimum Side ~~Yard~~ **Setback** for any Triplex, or Multi-Unit Dwelling is ten feet (10'). See Side ~~Yard~~ **Setback** Exceptions, Section 15-2.15-3(H).

### **15-2.16 Recreation Commercial (RC) District**

#### **15-2.16-3 Lot And Site Requirements**

- C. **FRONT YARD-SETBACK.** The minimum Front ~~Yard~~ **Setback** is twenty feet (20'). See Section 15-2.16-5 for Front ~~Yard~~ **Setback** requirements for Single Family and Duplex Dwellings.
- D. **FRONT YARD-SETBACK EXCEPTIONS.** The Front ~~Yard~~ **Setback** must be open and free of any Structure except:
- E. **REAR YARD-SETBACK.** The minimum Rear ~~Yard~~ **Setback** is ten feet (10'). See Section 15-2.16-5 for Rear ~~Yard~~ **Setback** requirements for Single Family and Duplex Dwellings.
- F. **REAR YARD-SETBACK EXCEPTIONS.** The Rear ~~Yard~~ **Setback** must be open and free of any Structure except:
  1. Bay Windows not more than ten feet (10') wide projecting not more than two feet (2') into the Rear ~~Yard~~ **Setback**.
  2. Chimneys not more than five feet (5') wide projecting not more than two feet (2') into the Rear ~~Yard~~ **Setback**.
  3. Window wells and light wells projecting not more than four feet (4') into the Rear ~~Yard~~ **Setback**.
  4. Roof overhangs and eaves projecting not more than three feet (3') into the Rear ~~Yard~~ **Setback**.

5. Window sills, belt courses, cornices, trim, exterior siding, and other ornamental features projecting not more than six inches (6") beyond the window or main Structure to which it is attached.
6. Detached Accessory Buildings not more than eighteen feet (18') in height and maintaining a minimum Rear ~~Yard~~ Setback of five feet (5'). Such Structures must not cover more than fifty percent (50%) of the Rear Yard. See the following illustration:

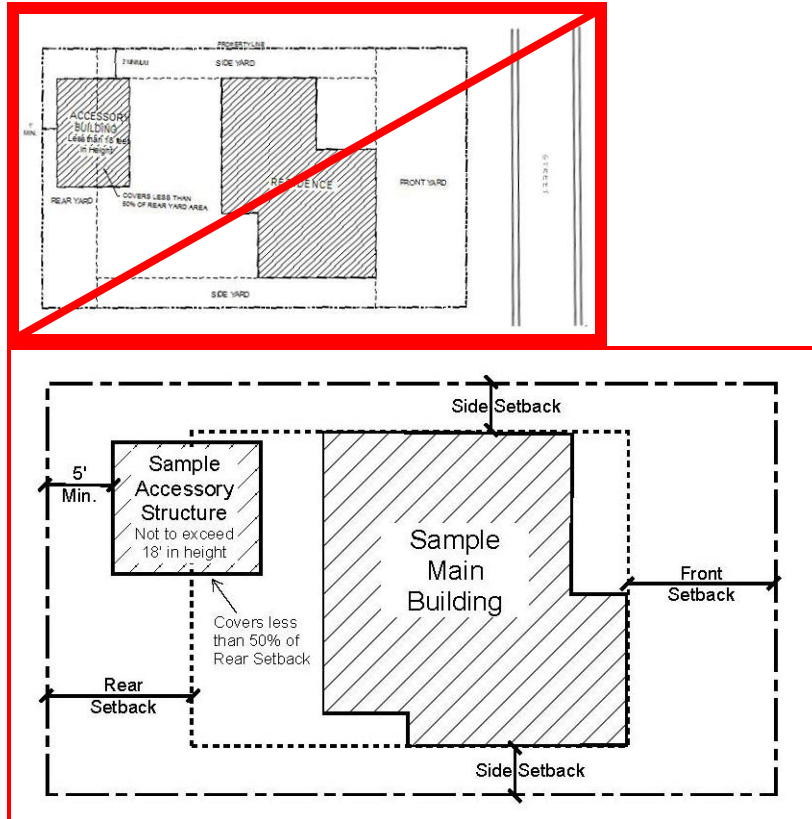

7. Hard-Surfaced Parking Areas subject to the same location requirements as a detached Accessory Building.
8. Mechanical equipment (which must be screened), hot tubs, or similar Structures located at least three feet (3') from the Rear Lot Line.
9. Fences, walls, and retaining walls not more than six feet (6') in height, or as permitted in Section 15-4-2. Retaining walls may have multiple steps, however, each exposed face cannot exceed six feet (6') in height and the horizontal distance between the walls, front face to rear face, must be at least three feet (3') and planted with approved vegetation. The Planning Director may approve minor deviations to the height and stepping requirements based on Site specific review.
10. Patios, decks, pathways, steps, and similar Structures not more than thirty inches (30") above Final Grade.

**G. SIDE YARD-SETBACK.**

1. The minimum Side ~~Yard~~ Setback is ten feet (10'). See Section 15-2.16-5 for Side ~~Yard~~ Setback requirements for Single Family and Duplex Dwellings.

2. A Side ~~Yard~~ **Setback** between connected Structures is not required where Structures are designed with a common wall on a Property Line and the Lots are burdened with a party wall agreement in a form approved by the City Attorney and Chief Building Official.

H. **SIDE ~~YARD-SETBACK~~ EXCEPTIONS**. The Side ~~Yard~~ **Setback** must be open and free of any Structure except:

1. Bay Windows not more than ten feet (10') wide, projecting not more than two feet (2') into the Side ~~Yard~~ **Setback**.
2. Chimneys not more than five feet (5') wide projecting not more than two feet (2') into the Side ~~Yard~~ **Setback**.
3. Window wells and light wells projecting not more than four feet (4') into the Side ~~Yard~~ **Setback**.
4. Roof overhangs and eaves projecting not more than three feet (3') into the Side ~~Yard~~ **Setback**.
5. Window sills, belt courses, cornices, trim, and other ornamental features projecting not more than six inches (6") beyond the window or main Structure to which it is attached.
6. Patios, decks, pathways, steps, and similar Structures not more than thirty inches (30") in height above Final Grade.
7. Fences, walls, and retaining walls not more than six feet (6') in height, or as permitted in Section 15-4-2. Retaining walls may have multiple steps, however, each exposed face cannot exceed six feet (6') in height and the horizontal distance between the walls, front face to rear face, must be at least three feet (3') and planted with approved vegetation. The Planning Director may approve minor deviations to the height and stepping requirements based on Site specific review.
8. Driveways leading to a garage or Parking Area maintaining a three foot (3') landscaped Setback to the Side Lot Line.
9. Detached Accessory Buildings not more than eighteen feet (18') in height, located a minimum of five feet (5') behind the front facade of the Main Building and maintaining a minimum Side ~~Yard~~ **Setback** of five feet (5').
10. Mechanical equipment (which must be screened), hot tubs, or similar Structures located at least three feet (3') from the Side Lot line.

**15-2.16-5 Special Requirements For Single Family And Duplex Dwellings**

C. **BUILDING PAD - RC DISTRICT**. The Building Pad is the Lot Area minus required Front, Rear and Side ~~Yard~~ **Setback** Areas.

D. **BUILDING FOOTPRINT – RC DISTRICT**.

TABLE 15-2.16

Lot Depth ≤/ft.*	Lot Width, ft. Up to:	Side <del>Yards</del> <b>Setbacks</b> Min. Total, ft.		Lot Area Sq. ft.	Bldg. Pad Sq. ft.	Max. Bldg. Footprint
75 ft.	25.0	3 ft.	6 ft.	1,875	1,045	844



75 ft.	37.5	3 ft.	6 ft.	2,813	1,733	1,201
75 ft.	50.0	5 ft.	10 ft.	3,750	2,200	1,519
75 ft.	62.5	5 ft.	14 ft.	4,688	2,668	1,801
75 ft.	75.0	5 ft.	18 ft.	5,625	3,135	2,050
75 ft.	87.5	10 ft.	24 ft.	6,563	3,493	2,270
75 ft.	100.0	10 ft.	24 ft.	7,500	4,180	2,460
75 ft.	Greater than 100.0	10 ft.	30 ft.	Greater than 75 ft.	Per Setbacks and Lot Area	Per formula

\*For Lots > 75' in depth use Footprint formula and Table 15-2.16a for Front and Rear Setbacks.

E. **FRONT AND REAR YARDS SETBACK.** Front and Rear **Yard Setbacks** are as follows:

Table 15-2.16a

Lot Depth	Min. Front/Rear Setback
Up to 75 ft., inclusive	10 ft.
From 75 ft. to 100 ft.	12 ft.
Over 100 ft.	15 ft.

F. **FRONT YARDS SETBACK EXCEPTIONS.** The Front **Yard Setback** must be open and free of any Structure except:

1. Fences or walls not more than four feet (4') in height, or as permitted in Section 15-4-2. Fences and Walls. On Corner Lots, Fences more than three feet (3') in height are prohibited within twenty-five feet (25') of the intersection at back of curb.
2. Uncovered steps leading to the Main Building; provided the steps are not more than four feet (4') in height from Final Grade, not including any required handrail, and do not cause any danger or hazard to traffic by obstructing the view of the Street or intersection.
3. Decks, porches, and Bay Windows not more than ten feet (10') wide, projecting not more than three feet (3') into the Front **Yard Setback**.
4. Roof overhangs, eaves, and cornices projecting not more than three feet (3') into the Front **Yard Setback**.
5. Sidewalks, patios, and pathways.

6. A driveway leading to a garage or Parking Area. No portion of a Front Yard, except for patios, driveways, allowed Parking Areas and sidewalks may be Hard-Surfaced or graveled.

G. **REAR YARDS SETBACK EXCEPTIONS.** The Rear ~~Yard~~ **Setback** must be open and free of any Structure except:

1. Bay Windows not more than ten feet (10') wide, projecting not more than two feet (2') into the Rear ~~Yard~~ **Setback**.
2. Chimneys not more than five feet (5') wide, projecting not more than two feet (2') into the Rear ~~Yard~~ **Setback**.
3. Window wells and light wells projecting not more than four feet (4') into the Rear ~~Yard~~ **Setback**.
4. Roof overhangs and eaves projecting not more than two feet (2') into the Rear ~~Yard~~ **Setback**.
5. Window sills, belt courses, cornices, trim, exterior siding, and other ornamental features projecting not more than six inches (6") beyond the window or main Structure to which it is attached.
6. Detached Accessory Buildings not more than eighteen feet (18') in height, located a minimum of five feet (5') behind the front façade of the Main Building, and maintaining a minimum Rear ~~Yard~~ **Setback** of one foot (1'). Such Structures may not cover more than fifty percent (50%) of the Rear Yard. See the following illustration:

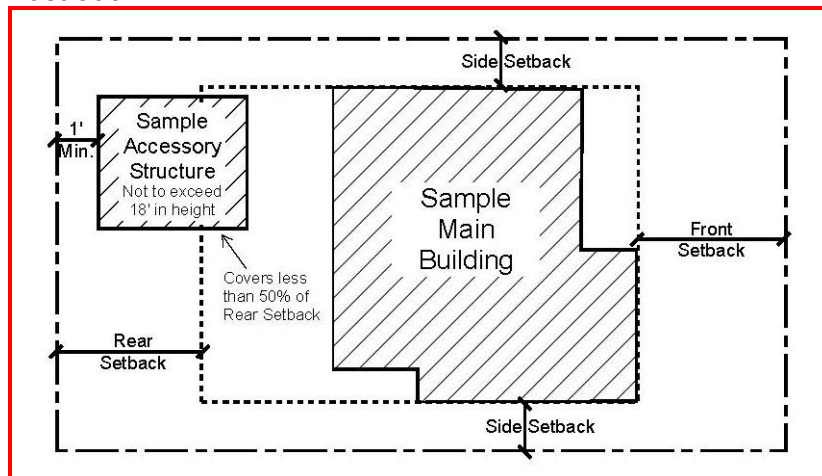

7. Hard-Surfaced Parking Areas subject to the same location requirements as a detached Accessory Building.
8. Mechanical equipment (which must be screened), hot tubs, or similar Structures located at least three feet (3') from the Rear Lot Line.
9. Fences and walls as permitted in Section 15-4-2, Fences and Walls.
10. Patios, decks, pathways, steps, and similar Structures not more than thirty inches (30") above Final Grade.
11. Pathways and steps connecting to a City staircase or pathway.

H. **SIDE YARDS SETBACKS.**

1. The minimum Side ~~Yard~~ **Yards Setback** is three feet (3'), but increases for Lots greater than thirty-seven and one-half feet (37.5') in Width, as per Table 15-2.16 above.
2. Site plans and Building designs must resolve snow release issues to the satisfaction of the Chief Building Official.
3. On Corner Lots, the minimum Side ~~Yard~~ **Yards Setback** that faces a side Street or platted Right-of-Way is five feet (5').
4. A Side ~~Yard~~ **Yards Setback** between connected Structures is not required where Structures are designed with a common wall on a Property Line, each Structure is located on an individual Lot, the Lots are burdened with a party wall agreement in a form approved by the City Attorney and Chief Building Official, all applicable Building and Fire Code requirements are met, and the Use is an Allowed or Conditional Use in the Zoning District.
  - a. Exterior Side ~~Yards~~ **Yards Setbacks** shall be based on the required minimum Side ~~Yard~~ **Yards Setback** for each Lot; however the Planning Commission may consider increasing exterior Side ~~Yards~~ **Yards Setbacks** during Conditional Use Permit review to mitigate potential impacts on adjacent Property. Side ~~Yard~~ **Yards Setback** exceptions continue to apply.
  - b. Building Footprint shall be based on the total lot Area of the underlying Lots. The Planning Commission may consider decreasing Building Footprint during Conditional Use Permit review to mitigate potential impacts on adjacent Property.

I. **SIDE ~~YARDS~~ **SETBACK** EXCEPTIONS.** The Side ~~Yard~~ **Yards Setback** must be open and free of any Structure except:

1. Bay Windows not more than ten feet (10') wide projecting not more than two feet (2') into the Side ~~Yard~~ **Yards Setback**.<sup>1</sup>
2. Chimneys not more than five Feet (5') wide projecting not more than two feet (2') into the Side ~~Yard~~ **Yards Setback**.<sup>1</sup>
3. Window wells and light wells Projecting not more than four feet (4') into the Side ~~Yard~~ **Yards Setback**.<sup>1</sup>
4. Roof overhangs and eaves projecting not more than two feet (2') into the Side ~~Yard~~ **Yards Setback**. A one foot (1') roof or eave overhang is permitted on Lots with a Side ~~Yard~~ **Yards Setback** of less than five feet (5').<sup>1</sup>
5. Window sills, belt courses, trim, cornices, exterior siding, and other ornamental features projecting not more than six inches (6") beyond the window or main Structure to which it is attached.

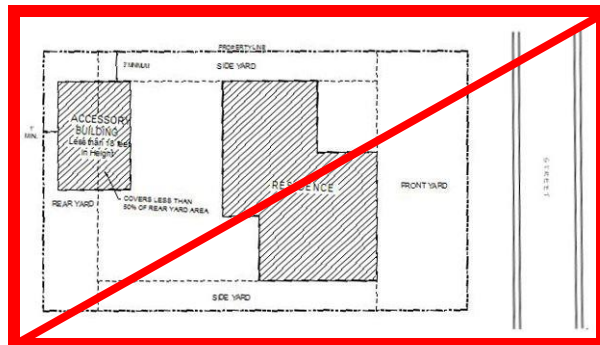

6. Patios, decks, pathways, steps, or similar Structures not more than thirty inches (30") in height from Final Grade.
7. Fences and walls as permitted in Section 15-4-2.
8. Driveways leading to a garage or approved Parking Area.
9. Pathways and steps connecting to a City staircase or pathway.
10. A detached Accessory Building, not more than eighteen feet (18') in height, located a minimum of five feet (5') behind the front facade of the Main Building, and maintaining a minimum Side ~~Yard~~ Setback of three feet (3'). See the following illustration:

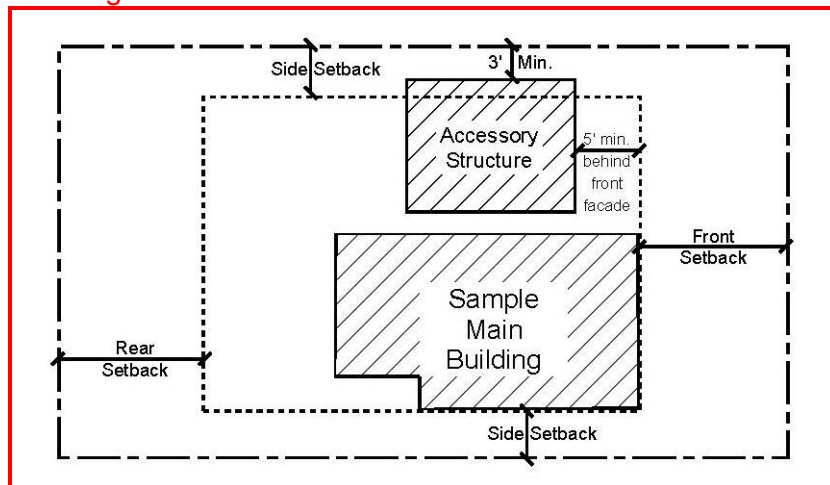

11. Mechanical equipment (which must be screened), hot tubs, or similar Structures located a minimum of three feet (3') from the Side Lot Line.
- J. **SNOW RELEASE.** Site plans and Building designs must resolve snow release issues to the satisfaction of the Chief Building Official.
- K. **CLEAR VIEW OF INTERSECTION.** No visual obstruction in excess of two feet (2') in height above Road Grade shall be placed on any Corner Lot within the Site Distance Triangle. A reasonable number of trees may be allowed, if pruned high enough to permit automobile drivers an unobstructed view. This provision must not require changes in the Natural Grade on the Site.
- L. **BUILDING HEIGHT.** No Single Family or Duplex Dwelling Structure shall be erected to a height greater than twenty-seven feet (27'). This is the Zone Height for Single Family and Duplex Dwellings. Final Grade must be within four vertical feet (4') of Existing Grade around the periphery of the Structure, except for the placement of approved window wells, emergency egress, and a garage entrance. The following height requirements must be met:
1. A Structure shall have a maximum height of thirty five feet (35') measured from the lowest finish floor plane to the point of the highest wall top plate that supports the ceiling joists or roof rafters.
  2. A ten foot (10') minimum horizontal step in the downhill façade is required unless the First Story is located completely under the finished Grade on all sides of the Structure. The horizontal step shall take place at a maximum height of twenty three feet (23') from where Building Footprint meets the lowest point of existing



Grade. Architectural features, that provide articulation to the upper story façade setback, may encroach into the minimum ten foot (10') setback but shall be limited to no more than twenty five percent (25%) of the width of the building encroaching no more than four feet (4') into the setback, subject to compliance with the Design Guidelines for Historic Sites and Historic Districts.

3. Roof Pitch. The primary roof pitch must be between seven:twelve (7:12) and twelve:twelve (12:12). A Green Roof may be below the required 7:12 roof pitch as part of the primary roof design. In addition, a roof that is not part of the primary roof design may be below the required 7:12 roof pitch.
  - a. A structure containing a flat roof shall have a maximum height of thirty five feet (35') measured from the lowest floor plane to the highest wall top plate that supports the ceiling joists or roof rafters. The height of the Green Roof, including the parapets, railings, or similar features shall not exceed twenty four inches (24") above the highest top plate mentioned above.

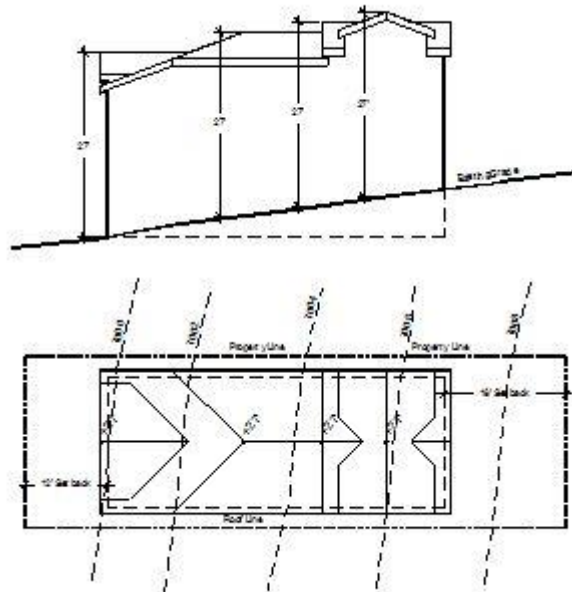

**M. BUILDING HEIGHT EXCEPTIONS.** The following height exceptions apply:

1. Antennas, chimneys, flues, vents, and similar Structures, may extend up to five feet (5') above the highest point of the Building to comply with International Building Code (IBC) requirements.
2. Water towers, mechanical equipment, and associated Screening, when Screened or enclosed, may extend up to five feet (5') above the height of the Building.
3. Elevator access. The Planning Director may allow additional height to allow for an elevator compliant with the American Disability Acts standards. The Applicant must verify the following:

- a. The proposed height exception is only for the Area of the elevator. No increase in square footage is being achieved.
  - b. The proposed option is the only feasible option for the elevator on the site.
  - c. The proposed elevator and floor plans comply with the American Disability Act (ADA) standards.
4. Garage on Downhill Lot. The Planning Commission may allow additional Building Height (see entire Section 15-2.16-5 (L) on a downhill Lot to accommodate a single car wide garage in a Tandem Parking configuration; to accommodate circulation, such as stairs and/or an ADA elevator; and to accommodate a reasonably sized front entry area and front porch that provide a Compatible streetscape design. The depth of the garage may not exceed the minimum depth for internal Parking Space(s) as dimensioned within this Code, Section 15-3. The additional Building Height may not exceed thirty-five feet (35') from Existing Grade.

<sup>1</sup>Applies only to Lots with a minimum Side **Yard Setback** of five feet (5') or greater.

### **15-2.16-8 Parking Regulations**

- D. A Parking Structure may occupy below Grade Side and Rear **Yards Setbacks** if the Structure maintains all Setbacks above Grade. Common Parking Structures requiring a Conditional Use permit are subject to a Conditional Use review, Chapter 15-1-10.

## **15-2.18 General Commercial (GC) District**

### **15-2.18-3 Lot And Site Requirements**

- A. **FRONT YARDS SETBACK**. The minimum Front **Yard Setback** is twenty feet (20') for all Main and Accessory Buildings and Uses. The twenty foot (20') Front **Yard Setback** may be reduced to ten feet (10'), provided all on-Site parking is at the rear of the Property or underground. The Frontage Protection Overlay Zone (FPZ) requires a minimum landscaped buffer of thirty-feet (30') in width abutting the Street. See Section 15-2.20. The Prospector Overlay allows reduced site requirements for designated Affected Lots. See Section 15-2.18-3(l)
- B. **FRONT YARD SETBACK EXCEPTIONS**. The Front **Yard Setback** must be open and free of any Structure except:
1. Fence, walls, and retaining walls not more than four feet (4') in height, or as permitted in Section 15-4-2. On Corner Lots, Fences more than three feet (3') in height are prohibited within twenty-five feet (25') of the intersection at back of curb.
  2. Uncovered steps leading to the Main Building; provided, the steps are not more than four feet (4') in height from Final Grade, not including any required handrails, and do not cause any danger or hazard to traffic by obstructing the view of the Street or intersection.
  3. Roof overhangs, eaves, and cornices projecting not more than three feet (3') into the Front **Yard Setback**.

4. Sidewalks, patios, and pathways.
  5. Decks, porches, and Bay Windows not more than ten feet (10') wide, projecting not more than three feet (3') into the Front ~~Yard~~ **Setback**.
  6. Driveways leading to a garage or Parking Area. No portion of a Front Yard, except for driveways, allowed Parking Areas and sidewalks may be Hard-Surfaced or graveled. See Section 15-3-3 General Parking Area and Driveway Standards.
  7. Circular driveways meeting all requirements stated in Section 15-3-4.
- C. **REAR YARD SETBACK**. The minimum Rear ~~Yard~~ **Setback** is ten feet (10'). The Prospector Overlay allows reduced site requirements for designated Affected Lots. See Section 15-1-2.18-3(l).
- D. **REAR YARD SETBACK EXCEPTIONS**. The Rear ~~Yard~~ **Setback** must be open and free of any Structure except:
1. Bay Window or chimneys not more than ten feet (10') wide, projecting not more than two feet (2') into the Rear ~~Yard~~ **Setback**.
  2. Window wells and light wells projecting not more than four feet (4') into the Rear ~~Yard~~ **Setback**.
  3. Roof overhangs and eaves projecting not more than three feet (3') into the Rear ~~Yard~~ **Setback**.
  4. Window sills, belt courses, cornices, trim and other ornamental features projecting not more than six inches (6") beyond the window or main Structure to which it is attached.
  5. Detached Accessory Buildings not more than eighteen feet (18') in height and maintaining a minimum Rear ~~Yard~~ **Setback** of five feet (5'). Such Structures must not cover more than fifty percent (50%) of the Rear Yard. See the following illustration:

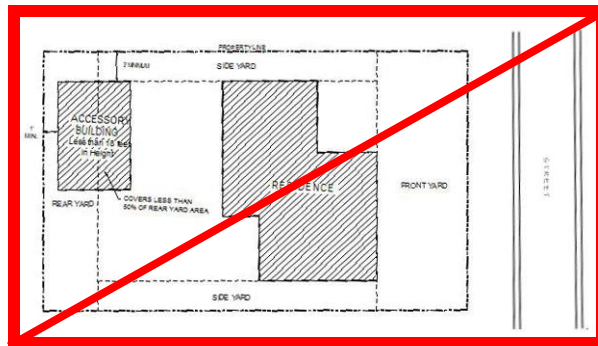

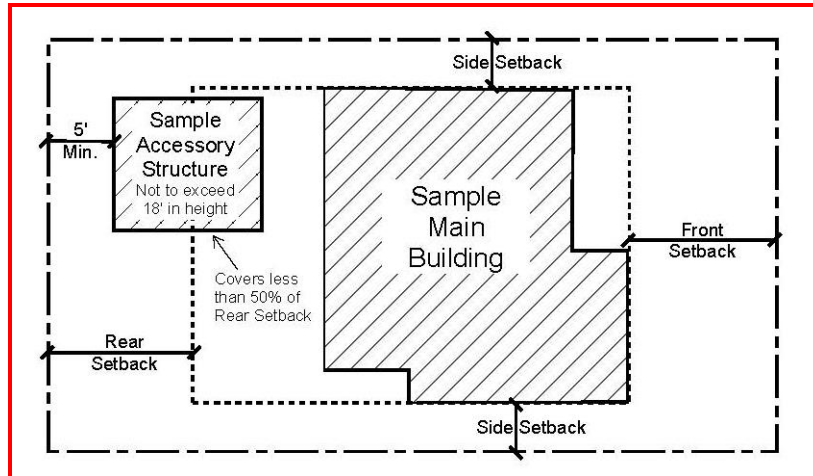

6. Hard-Surfaced Parking Areas subject to the same location requirements as a detached Accessory Buildings and meeting all landscaping requirements stated in Section 15-3-3.
7. Screened mechanical equipment, hot tubs, and similar Structures located at least five feet (5') from the Rear Lot Line.
8. Fences, walls, and retaining walls not more than six feet (6') in height, or as permitted in Section 15-4-2. Retaining walls may have multiple steps, however, each exposed face cannot exceed six feet (6') in height and the horizontal distance between the walls, front face to rear face, must be at least three feet (3') and planted with approved vegetation.

The Planning Director may approve minor deviations to the height and stepping requirements based on Site specific review.

9. Patios, decks, pathways, steps, and similar Structures not more than thirty inches (30") above Final Grade, provided it is located at least five feet (5') from the Rear Lot Line.
10. Enclosed porches, including a roof and open on three (3) sides, and similar Structures not more than nine feet (9') into the Rear ~~Yard~~ **Yard Setback** provided the adjoining Property is dedicated as Natural or Landscaped Open Space and meets minimum International Building Code (IBC) and Fire Code requirements.

**E. SIDE ~~YARD~~ **YARD SETBACK.****

1. The minimum Side ~~Yard~~ **Yard Setback** is ten feet (10').
2. A Side ~~Yard~~ **Yard Setback** between connected Structures is not required where Structures are designed with a common wall on a Property Line, each Structure is located on an individual Lot, the Lots are burdened with a party wall agreement in a form approved by the City Attorney and Chief Building Official, all applicable Building and Fire Code requirements are met, and the Use is an Allowed or Conditional Use in the Zoning District.
  - a. Exterior Side ~~Yards~~ **Yards Setbacks** shall be based on the required minimum Side ~~Yard~~ **Yard Setback** for each Lot; however the Planning Commission may consider increasing exterior Side ~~Yards~~ **Yards Setbacks** during Conditional Use Permit review to mitigate potential impacts on adjacent Property. Side ~~Yard~~ **Yard Setback** exceptions continue to apply.



3. The minimum Side **Yard Setback** for a Detached Accessory Building not greater than eighteen feet (18') in height, located at least five feet (5') behind the front facade of the Main Building must be one foot (1'), except when an opening is proposed on an exterior wall adjacent to the Property Line, at which time the minimum Side **Yard Setback** must be three feet (3'). See the following illustration:

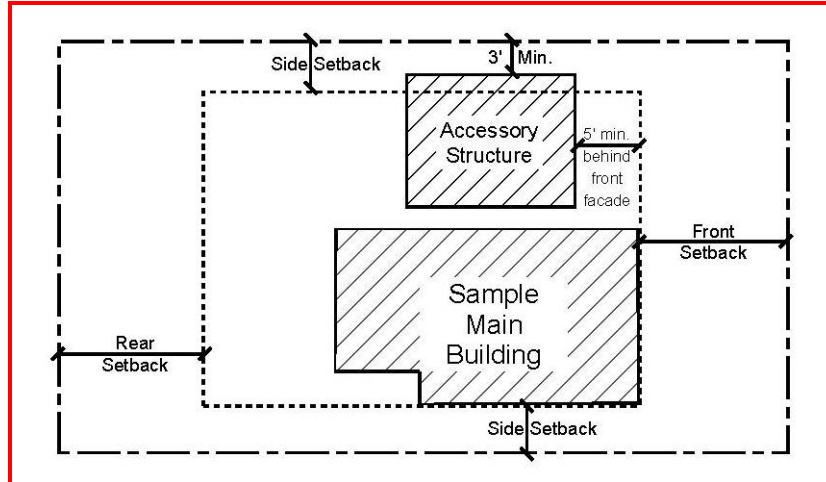

4. On Corner Lots, the Side Yard that faces a Street is considered a Front Yard and the Setback must not be less than twenty feet (20').
5. The Prospector Overlay allows reduced site requirements for designated Affected Lots. See Section 15-2.18-3(l).

F. **SIDE YARD SETBACK EXCEPTIONS.** The Side **Yard Setback** must be open and free of any Structure except:

1. Bay Windows and chimneys not more than ten feet (10') wide projecting not more than two feet (2') into the Side **Yard Setback**.
2. Window wells and light wells projecting not more than four feet (4') into the Side **Yard Setback**.
3. Roof overhangs and eaves projecting not more than three feet (3') into the Side **Yard Setback**.
4. Window sills, belt courses, cornices, trim, and other ornamental features projecting not more than six inches (6") beyond the window or main Structure to which it is attached.
5. Patios, decks, pathways, steps, and similar Structures not more than thirty inches (30") above Grade, provided there is at least one foot (1') Setback from the Side Lot Line.
6. Awnings over a doorway or window extending not more than three feet (3') into the Side **Yard Setback**.
7. Fences, walls, and retaining walls not more than six feet (6') in height, or as permitted in Section 15-4-2. Retaining walls may have multiple steps, however, each exposed face cannot exceed six feet (6') in height and the horizontal distance between the walls, front face to rear face, must be at least three feet (3') and planted with approved vegetation. The Planning Director may approve minor deviations to the height and stepping requirements based on Site specific review.
8. Driveways leading to a garage or Parking Area maintaining a three foot (3') landscaped Setback to the Side Lot Line.

9. Paths and steps connecting to a City stairway, trail, or path.
  10. Screened mechanical equipment, hot tubs, and similar Structures located a minimum of five feet (5') from the Side Lot Line.
  11. Unenclosed porches, including a roof and open on three (3) sides, and similar Structures not more than nine feet (9') into the Side **Yard Setback** provided the adjoining Property is dedicated as Natural or Landscaped Open Space and meets minimum International Building Code (IBC) and Fire Code requirements.
- G. **SNOW RELEASE**. Site plans and Building design must resolve snow release issues to the satisfaction of the Chief Building Official.
- H. **CLEAR VIEW OF INTERSECTION**. No visual obstruction in excess of two feet (2') in height above Road Grade shall be placed on any Corner Lot within the Site Distance Triangle. A reasonable number of trees may be allowed, if pruned high enough to permit automobile drivers an unobstructed view. This provision must not require changes in the Natural Grade on the Site.
- I. **PROSPECTOR OVERLAY ESTABLISHING A MAXIMUM FLOOR AREA FOR DEVELOPMENT**. The following requirements apply to specific Lots in the Prospector Square Subdivision:
1. **AFFECTED LOTS**. Lots 2A through Lot 49D, except Lots 40, 41, 42, 43, 44, 45, and 46, and parking Lots A through K as shown on the Amended Prospector Square Subdivision Plat.
  2. **MAXIMUM FLOOR AREA RATIO (FAR)**. The FAR must not exceed two (2.0) for all Affected Lots as specified above. All Uses within a Building, except enclosed Parking Areas, are subject to the Floor Area Ratio (FAR). Parking Lots A - K must have no Use other than parking and related Uses such as snow plowing, striping, repaving and landscaping.
  3. **REDUCED SITE REQUIREMENTS**. In the Prospector Square Subdivision, Front, Side and Rear **Yards Setbacks** may be reduced to zero feet (0') for all Affected Lots as specified above. Commercial Lots within the Frontage Protection Zone shall comply with FPZ **sSetbacks** per LMC Section 15-2-20. This section is not intended to conflict with the exceptions listed above nor shall it be interpreted as taking precedence over the requirement of Section 15-2.18-3(H) Clear View of Intersection.

## **15-2.19 Light Industrial (LI) District**

### **15-2.19-5 Lot And Site Requirements**

- C. **FRONT YARD SETBACK**. The minimum Front **Yard Setback** is thirty feet (30').
- D. **FRONT YARD SETBACK EXCEPTIONS**. The Front **Yard Setback** must be open and free of any Structure except:
1. Fences, walls, and retaining walls not more than four feet (4') in height, or as permitted in Section 15-4-2. On Corner Lots, Fences more than three feet (3') in

height are prohibited within twenty-five feet (25') of the intersection at back of curb.

2. Uncovered steps leading to the Main Building; provided the steps are not more than four feet (4') in height from Final Grade, not including any required handrails, and do not cause danger or hazard to traffic by obstructing the view of the Street or intersection.
  3. Roof overhangs, eaves, and cornices projecting not more than three feet (3') into the Front ~~Yard~~ **Setback**.
  4. Sidewalks, patios, and pathways.
  5. Decks, porches, and Bay Windows not more than ten feet (10') wide, projecting not more than three feet (3') into the Front ~~Yard~~ **Setback**.
  6. Driveway leading to a garage or Parking Area. No portion of a Front Yard except for driveways and/or allowed Parking Areas and sidewalks may be Hard-Surfaced or graveled. See Section 15-3.3 General Parking Area and Driveway Standards.
  7. Circular driveways meeting all requirements stated in Section 15-3-4.
- E. **REAR ~~YARD~~ SETBACK**. The minimum Rear ~~Yard~~ **Setback** is ten feet (10').
- F. **REAR ~~YARD~~ SETBACK EXCEPTIONS**. The Rear ~~Yard~~ **Setback** must be open and free of any Structure except:
1. Bay Windows and Chimneys not more than ten feet (10') wide projecting not more than two feet (2') into the Rear ~~Yard~~ **Setback**.
  2. Light wells and window wells projecting not more than four feet (4') into the Rear ~~Yard~~ **Setback**.
  3. Roof overhangs and eaves projecting not more than three feet (3') into the Rear ~~Yard~~ **Setback**.
  4. Window sills, belt courses, cornices, trim, or other ornamental features projecting not more than six inches (6') beyond the window or Structure to which it is attached.
  5. Detached Accessory Buildings not more than eighteen feet (18') in height and maintaining a minimum Rear ~~Yard~~ **Setback** of five feet (5'). Such Structures must not cover more than fifty percent (50%) of the Rear Yard. See the following illustration:

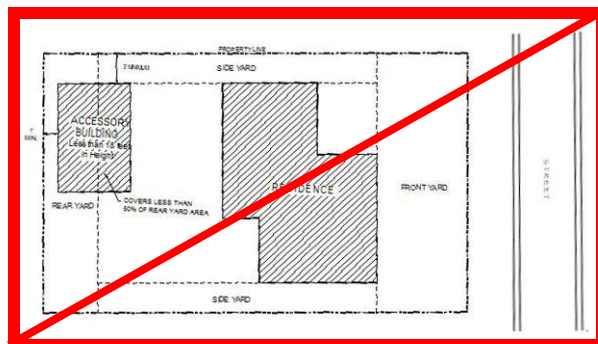

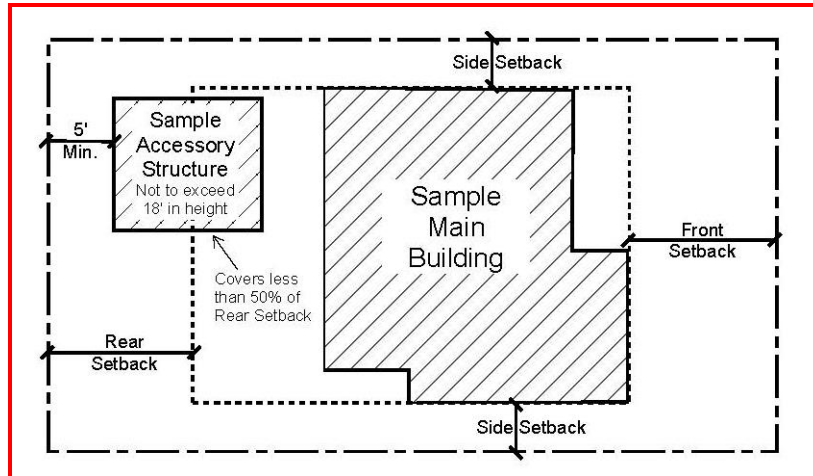

6. Hard-Surfaced Parking Areas subject to the same location requirements a detached Accessory Building meeting all landscaping requirements stated in LMC Chapter 15-3-3 and Title 14.
7. Screened mechanical equipment, hot tubs, and similar Structures located at least five feet (5') from the Rear Lot Line.
8. Fences, walls, and retaining walls not more than six feet (6') in height, or as permitted in Section 15-4-2. Retaining walls may have multiple steps, however, each exposed face cannot exceed six feet (6') in height and the horizontal distance between the walls, front face to rear face, must be at least three feet (3') and planted with approved vegetation. The Planning Director may approve minor deviations to the height and stepping requirements based on Site specific review.<sup>1</sup>
9. Patios, decks, pathways, steps, and similar Structures not more than thirty inches (30") above Final Grade provided it is located at least five feet (5') from the Rear Lot Line.

**G. SIDE YARD SETBACK.**

1. The minimum Side **Yard Setback** is ten feet (10').
2. A Side **Yard Setback** between connected Structures is not required where Structures are designed with a common wall on a Property Line, each Structure is located on an individual Lot, the Lots are burdened with a party wall agreement in a form approved by the City Attorney and Chief Building Official, all applicable Building and Fire Code requirements are met, and the Use is an Allowed or Conditional Use in the Zoning District.
  - a. Exterior Side **Yard Setback** shall be based on the required minimum Side **Yard Setback** for each Lot; however the Planning Commission may consider increasing exterior Side **Yard Setback** during Conditional Use Permit review to mitigate potential impacts on adjacent Property. Side **Yard Setback** exceptions continue to apply.
3. The minimum Side **Yard Setback** for a detached Accessory Buildings not more than eighteen feet (18') in height, located a minimum of five feet (5') behind the front facade of the Main Building, ~~and maintaining a minimum Side Yard~~ is five feet (5').



4. On Corner Lots, the Side Yard that faces a Street is considered a Front Yard and the Setback must not be less than twenty feet (20').
- H. **SIDE YARD SETBACK EXCEPTIONS**. The Side ~~Yard~~ **Setback** must be open and free of any Structure except:
1. Bay Windows and chimneys not more than ten feet (10') wide, projecting not more than two feet (2') into the Side ~~Yard~~ **Setback**.
  2. Window wells and light wells projecting not more than four feet (4') into the Side ~~Yard~~ **Setback**.
  3. Roof overhangs and eaves projecting not more than three feet (3') into the Side ~~Yard~~ **Setback**.
  4. Window sills, belt courses, cornices, trim, and other ornamental features projecting not more than six inches (6") beyond the window or main Structure to which it is attached.
  5. Patios, decks, pathways, steps, and similar Structures not more than thirty inches (30") above Grade, provided there is at least one foot (1') Setback from the Side Lot Line.
  6. Awnings over doorways and windows projecting not more than three feet (3') into the Side ~~Yard~~ **Setback**.
  7. Fences, walls, and retaining walls not more than six feet (6') in height, or as permitted in Section 15-4-2. Retaining walls may have multiple steps, however, each exposed face cannot exceed six feet (6') in height and the horizontal distance between the walls, front face to rear face, must be at least three feet (3') and planted with approved vegetation. The Planning Director may approve minor deviations to the height and stepping requirements based on Site specific review.<sup>1</sup>
  8. Driveways leading to a garage or Parking Area maintaining a three foot (3') landscaped Setback to the Side Lot Line.
  9. Paths and steps connecting to a City stairway, trail, or path.
  10. Screened mechanical equipment, hot tubs, and similar Structures located a minimum of five feet (5') from the Side Lot Line.

## **15-2.22 Public Use Transition (PUT) District**

### **15-2.22-3 Lot And Size Requirements**

- B. **FRONT, REAR AND SIDE YARDS SETBACKS**. There are no minimum required Front, Rear, or Side ~~Yard~~ **Setback** dimensions in the PUT District; however, where new construction abuts a residential zone, the new construction shall meet the required minimum Setback of the abutting zone.

## **15-2.23 Community Transition (CT) District**

### **15-2.23-3 Lot And Size Requirements**

- B. **FRONT, REAR AND SIDE YARDS SETBACKS**. The minimum Front, Side, and Rear ~~Yards~~ **Setbacks** for all Structures is twenty-five feet (25'). The Planning Commission may

vary required ~~yards~~ **Setbacks** in Subdivisions and Master Planned Developments. In no case shall the Planning Commission reduce Side ~~Yards~~ **Setbacks** to allow less than ten feet (10') between Structures. Setbacks may be further restricted by Frontage Protection Overlay (FPZ) standards and/or Master Planned Development conditions of approval.

1. A Side ~~Yard~~ **Setback** between connected Structures is not required where Structures are designed with a common wall on a Property Line, each Structure is located on an individual Lot, the Lots are burdened with a party wall agreement in a form approved by the City Attorney and Chief Building Official, all applicable Building and Fire Code requirements are met, and the Use is an Allowed or Conditional Use in the Zoning District.
  2. Exterior Side ~~Yard~~ **Setback** shall be based on the required minimum Side ~~Yard~~ **Setback** for each Lot; however the Planning Commission may consider increasing exterior Side ~~Yards~~ **Setbacks** during Conditional Use Permit review to mitigate potential impacts on adjacent Property. Side ~~Yard~~ **Setback** exceptions continue to apply.
- C. **FRONT, SIDE, AND REAR ~~YARDS~~ SETBACK EXCEPTIONS.** Fences, walls, stairs, paths, trails, sidewalks, patios, driveways, Ancillary Structures, and approved Parking Areas are allowed as exceptions in the Front, Side, and Rear ~~Yards~~ **Setbacks**. Screened mechanical and utility equipment, hot tubs, and decks are allowed as exceptions in the Side and Rear ~~Yards~~ **Setbacks** provided that a minimum five feet (5') Setback is maintained.

**15-3-3 General Parking Area And Driveway Standards**

Off-Street parking shall meet the following standards:

- B. **SURFACING.** Parking Areas and driveways must be Hard-Surfaced, maintained in good condition, and clear of obstructions at all times. See Required **Yard Setback** Exceptions in Chapter 2 for further drive and parking requirements in specific Zoning Districts.
  
- I. **TANDEM SPACES.** Parking designs, which necessitate parking one vehicle directly behind another, not perpendicular to each other, are permitted only for Single Family Dwellings, Accessory Apartments, and Duplex Dwellings in all zoning districts. In any Zoning District where the Front **Yard Setback** is twenty feet (20') or less, both Parking Spaces must be perpendicular to the Street, unless there is an adequate landscaped buffer between the Street and Parking pad, subject to review by the Planning Director.

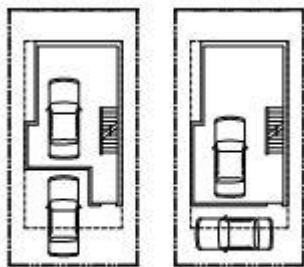

Yes

No

**15-3-4 Specific Parking Area And Driveway Standards For Single Family Residences And Duplexes, Parking Areas With 5 Or More Spaces, And Parking Structures**

**B. PARKING AREAS WITH FIVE (5) OR MORE SPACES.**

- 1. All Parking Lots shall maintain the required Front and Side **Yard Setbacks** as would be required for any Structure.

### 15-4-2 Fences And Retaining Walls

- A. **LOCATION.** Fences and retaining walls may be erected or allowed within the buildable Area, and as allowed in the Setback exceptions in Chapter 2.

Fences and retaining walls shall not exceed six feet (6') in height measured from Final Grade within any required Rear **Yard Setback** or Side **Yard Setback**. Within any required Front **Yard Setback** or Street Side **Yard Setback**, Fences and retaining walls shall not exceed four feet (4') in height, measured from Final Grade.

Where a Fence or retaining wall occurs along a Property Line separating two (2) Lots and there is a difference in the Grade of the Properties, the Fence or retaining wall may be erected or allowed to the maximum height permitted on either side of the Property Line.

1. **EXCEPTION.** The height of retaining walls in the Front **Yard Setback** may exceed four feet (4'), measured from Final Grade, subject to approval by the Planning Director and City Engineer, and may exceed six feet (6') in height subject to approval of an Administrative Conditional Use permit or as approved as part of a Master Planned Development (MPD) or Conditional Use permit. Prior to issuance of an Administrative Conditional Use permit the Property shall be posted and affected adjacent Property Owners shall be noticed ten (10) days prior to Final Action.

The height of retaining walls in the Side or Rear **Yard Setback** may exceed six feet (6'), measured from Final Grade, subject to approval of an Administrative Conditional Use permit or as approved as part of a Master Planned Development or Conditional Use permit. Prior to issuance of an Administrative Conditional Use permit the Property shall be posted and affected adjacent Property Owners shall be noticed ten (10) days prior to Final Action.

- B. **RESTRICTIONS ON MATERIALS.** Chain link Fences are prohibited in all zones with the following exceptions, which must be approved by the Planning Director.

1. For recreational facilities such as tennis courts,
2. As temporary limits of disturbance, fencing during construction as approved by the Planning Department.
3. Chain link Fences within the required **Yard Setback** Areas may be permitted in other circumstances by the Planning Director when it is found that the Fence is necessary in the interest of security or public safety, and when the Fencing needs cannot be reasonably met with any other type of Fencing .

- C. **BERMS.** Berms within the required **Yard Setback** Area may be constructed subject to the following:

1. Landscaping shall be incorporated into the design of the berm and shall extend its entire length.



2. Berms shall be designed with sufficient undulation to provide visual relief and shall meander for the entire length.
3. Within Front ~~Yard~~ **Setback** Areas berms may not be constructed to interfere with required sight distance and may not obstruct driver's line of sight from Streets and roads.

D. **PERMIT.** A Building Permit is required for construction of any Fence or retaining wall greater than six feet (6') in height. Within any of the Historic zoning districts construction of any Fence or retaining wall greater than four feet (4') in height requires a Building Permit.

#### **15-4-9 Child Care And Child Care Facilities**

##### **E. CHILD CARE CENTER.**

##### **2. SITE REQUIREMENTS.**

G. **Setbacks.** Standard Setbacks shall be observed except that Child Care Centers located in residential Districts shall provide at least eighteen foot (18') Side ~~Yard~~ **Setbacks** and twenty-five foot (25') ~~Rear yards~~ **Setbacks**.

I. **Signs.** One (1) small sign, either free-standing or wall mounted, may be permitted for a Child Care Center. The sign must be no larger than six square feet (6 sq. ft.) ~~Setback set back~~ at least ten feet (10') from the Property Line and must conform to all other criteria of the Park City Sign Code.

**15-15-1 Definitions**

**BUILDING PAD.** The exclusive Area, as defined by the ~~Yard Setbacks~~, in which the entire Building Footprint may be located. See the following example; also see Limits of Disturbance.

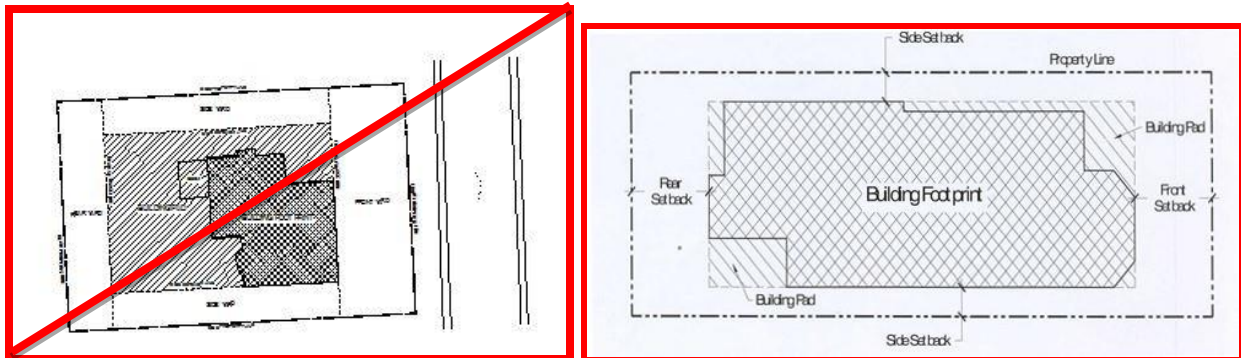

**LOT WIDTH.** The minimum distance between the Side Lot Lines at the Front ~~Yard Setback~~ or Front Building Façade. See the following illustration:

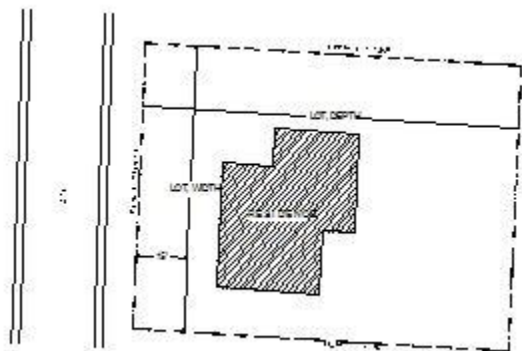

**SETBACK.** The area of a Lot that must remain open and cannot be built over with a Structure. This is the minimum horizontal distance between a specified lot line (front, side, rear), measured along a straight line and at a right angle to such lot line, and the nearest point of an above grade or below grade building or structure. The required minimum distance between a Building Pad and the closest of the following:

1. ~~Property Line;~~
2. ~~platted Street; or~~
3. ~~existing curb or edge of a Street.~~

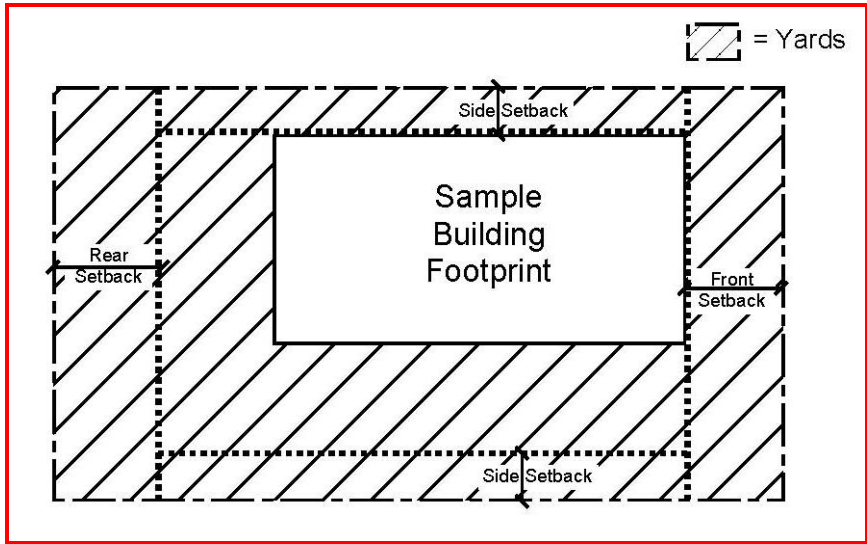

**YARD.** The portion of a Lot between any Property Line and the nearest point of the Main Building.

1. **Yard, Front.** A yard extending across the full width of the Lot between the Front Lot Line and the nearest line or point of the Building. ~~The Area between the front of the closest Building and the Front Lot Line or closer Right of Way, extending the full width of the Lot. The “depth” of the Front Yard is the minimum distance between the Front Lot Line and the front line of the closest Structure.~~
2. **Yard, Rear.** A yard extending across the full width of the Lot between the Rear Lot Line and the nearest line or point of the Building. ~~The Area between the rear line of the closest Building and the Rear Lot Line, or closer Right of Way, and extending the full width of the Lot. The “depth” of the Rear Yard is the minimum distance between the Rear Lot Line and the rear line of the closest Structure.~~
3. **Yard, Side.** A yard extending from the Front Yard to the Rear Yard between the Side Lot Line and the nearest line or point of the Building. ~~The Area between the side line of the Building and the Side Lot Line and extending from the Front Yard to the Rear Yard. The “width” of the Side Yard shall be the minimum distance between the Side Lot Line and the side line of the closest Structure.~~ See the following illustration:

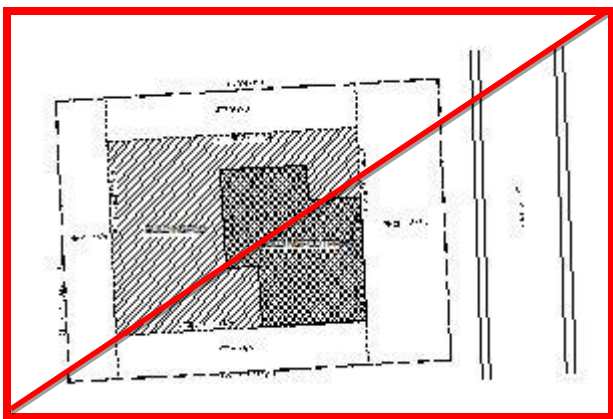

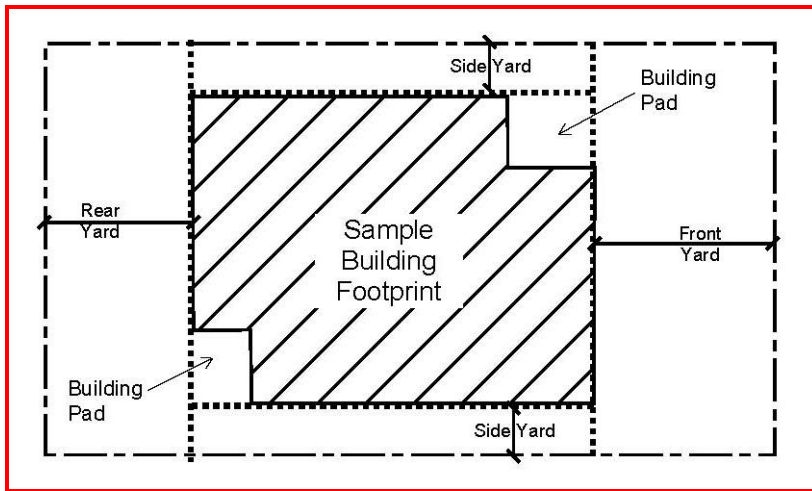



## Planning Commission Staff Report

**Subject:** 1304 Park Avenue Plat Amendment      **PLANNING DEPARTMENT**  
**Author:** Liz Jackson, Planning Technician  
              Anya Grahn, Historic Preservation Planner  
**Project Number:** PL-17-03539  
**Date:** June 13, 2018  
**Type of Item:** Legislative – Plat Amendment

### Summary Recommendations

Staff recommends the Planning Commission hold a public hearing for the 1304 Park Avenue Plat Amendment located at the same address and consider forwarding a positive recommendation to the City Council based on the Findings of Fact, Conclusions of Law, and Conditions of Approval as found in the draft ordinance.

### Description

**Applicant:** Mary Grace LLC (Jeff Volmrich)  
**Location:** 1304 Park Avenue  
**Zoning:** Historic Residential - Medium Density (HRM)  
**Adjacent Land Uses:** Single and multi-family residential development  
**Reason for Review:** Plat Amendments require Planning Commission review and City Council review and action.

### Proposal

The applicant is proposing to create a legal lot of record from a metes and bounds parcel. The southern half of the site contains a portion of the vacated Calhoun Street. The total square footage of the lot is 4,125 square feet. The house at 1304 Park Avenue is designated as designated as “Landmark” on the City’s Historic Sites Inventory (HSI).

### Background

In April 1998, Jeff Volmrich (Mary Grace LLC) purchased the property. In June 2000, the property owner was awarded a Historic District Grant from Park City Municipal Corporation for \$2,596. A façade easement was not required in return for the grant funds at the time of the award. In 2009, the site was designated as “Landmark” on the Historic Sites Inventory (see [Historic Site Form](#)).

In 2012, the Park City Redevelopment Agency (RDA) included this property as part of the Lower Park Avenue RDA.

This property has had limited land use applications in the past. On February 7, 2017, the applicant submitted a Historic District Design Review Pre-application (pre-app) to



discuss opportunities for renovating the historic house and development opportunities for the lot. Staff provided input regarding the pre-application and process for Historic District Design Review (HDDR) process. It was deemed that the applicant would need a plat amendment in order to develop the site any further.

On April 19, 2017 the applicant submitted a Plat Amendment application, which was deemed complete on April 28, 2017. Staff placed the application on hold while the applicant considered redevelopment options for the site. On April 25, 2018, the applicant returned to the City and asked that we move forward with processing the plat.

On April 16, 2018 the Planning Department received a second Historic District Design Review (HDDR) pre-application for the property at 1304 Park Avenue. As the applicant needed to complete the plat amendment process and the applicant is still considering options for the site, the Historic District Design Review (HDDR) pre-application has not yet moved into a full HDDR.

### **Purpose**

The purpose of the HRM District is to:

- A. allow continuation of permanent residential and transient housing in original residential Areas of Park City,
- B. encourage new Development along an important corridor that is Compatible with Historic Structures in the surrounding Area,
- C. encourage the rehabilitation of existing Historic Structures,
- D. encourage Development that provides a transition in Use and scale between the Historic District and the resort Developments,
- E. encourage Affordable Housing,
- F. encourage Development which minimizes the number of new driveways  
Accessing existing thoroughfares and minimizes the visibility of Parking Areas,  
and
- G. establish specific criteria for the review of Neighborhood Commercial Uses in Historic Structures along Park Avenue.

### **Analysis**

The purpose of this application is to create one (1) legal lot of record from a metes and bounds parcel. The applicant proposes to maintain and renovate the historic house on the proposed lot.

The following are the lot and site requirements of LMC for the HRM.

	LMC Requirements for HRM District (Based on Existing Lot Size):	Existing Conditions:
Minimum Lot Size	1,875 sf.	4,125 sf., <i>complies.</i>
Minimum Lot Width	37.50 ft., minimum	55 ft., <i>complies.</i>
Allowed Footprint	844 sf.	1,636 sf., <i>complies.</i>
Setbacks		
Front/Rear Yard	10 ft.	0 ft. front, <i>complies</i> (encroaches approx. 1 ft.) <sup>1</sup> .
Rear Yard	10 ft.	1 ft. rear yard <sup>2</sup> , <i>complies.</i>
Side Yard	5 ft.	3 and 5 ft. side, <i>complies</i> <sup>1</sup> .
Building Height above Existing Grade	27 feet	16.8 feet

<sup>1</sup> Per LMC 15-2.4-6, Existing Historic Structures that do not comply with Building Setbacks, Off-Street parking, Building Height, Building Footprint, and driveway location standards are Valid Non-complying Structures.

<sup>2</sup> Shed that is located on the southeast corner of the property in the rear yard. Per LMC (F)(6), detached Accessory Buildings not more than 18 feet in height located a minimum of 5 ft. behind the front façade of the Main Building may have a rear yard setback of 1 ft.

There are several existing encroachments on site. The existing historic house, constructed in 1885, encroaches between six inches (6”) to 1 foot (1’), increasing from north to south, over the front property line and into the city right-of-way. The front porch encroaches less than 1 foot (1’) over the front property line and into the City right-of-way. The house and front porch encroachments measure at thirty six linear feet (36’). There is an existing fence that runs along both sides and the rear property lines, which crosses over the property line into the Cottages on the Park property that wraps the north and east sides of this property. There is also a concrete retaining wall that encroaches into the City right-of-way in front of the 1304 Park Avenue property line (southwest corner) and onto the Coalition Lodge Condominium property at 1300 Park Avenue. Staff has added the following Conditions of Approvals to address these issues:

*#4. The fence encroaches at multiple points over the property line into the neighboring Cottages on the Park Subdivision. The applicant shall either remove the existing fence or enter into an encroachment agreement with the neighbor if the fence is to remain in its existing location.*

*#5. The existing concrete retaining wall encroaches approximately seven feet (7') into the right-of-way. The applicant shall remove the existing retaining wall prior to recordation of this plat amendment.*

*#6. The existing main building and front porch encroach approximately 1 foot (1') into the right-of-way. The applicant will work with the City Engineer to enter into an encroachment agreement for this.*

The City Engineer will also require the dedication of ten foot (10') snow storage easements along Park Avenue (see Condition of Approval #3).

Staff finds that the plat, as conditioned, to create one (1) legal lot of record from a metes and bounds parcel, by removing an interior block line, will not cause undo harm to adjacent property owners because the proposed plat meets the requirements of the Land Management Code for the HRM zoned portions and all future development will be reviewed for compliance with requisite Building and Land Management Code requirements in effect at the time of application for building permits. The property is surrounded by single-family and multi-family dwellings that are located on one (1) to two (2) lot combinations. Directly to the north and east is the Cottages on the Park Subdivision, which includes four (4) units.

### **Good Cause**

Staff finds good cause for this Plat Amendment as the City will receive a snow storage easement along Park Avenue. This plat will also resolve existing encroachments into the City's right-of-way, including the house, front porch, and concrete retaining wall.

### **Process**

The approval of this plat amendment application by the City Council constitutes Final Action that may be appealed following the procedures found in LMC §15-1-18.

### **Department Review**

This project has gone through an interdepartmental review. No further issues were brought up at that time.

### **Notice**

On May 30, 2018, the property was posted and notice was mailed to property owners within 300 feet. Legal notice was also published in the Park Record and the Utah Public Notice Website on May 26, 2018, according to requirements of the Land Management Code.

### **Public Input**

No public input has been received by the time of this report.

### **Alternatives**

- The Planning Commission may forward positive recommendation to the City Council for the 1304 Park Avenue Plat Amendment, located at the same address, as conditioned or amended; or
- The Planning Commission may forward a negative recommendation to the City Council for the 1304 Park Avenue Plat Amendment, located at the same address, and direct staff to make Findings for this decision; or
- The Planning Commission may continue the discussion on the 1304 Park Avenue Plat Amendment for additional information to address comments raised at the meeting.

### **Significant Impacts**

There are no significant fiscal or environmental impacts from this application.

### **Consequences of not taking recommended action**

Consequences of not taking the Planning Department's recommendation are that the encroachments would not be resolved with the plat and the site would continue to be metes and bounds parcel. The historic house would straddle an interior block line and any additions to the house would be required to meet setbacks based on existing lot lines.

### **Summary Recommendation**

Staff recommends the Planning Commission hold a public hearing for the 1304 Park Avenue Plat Amendment located at the same address and consider forwarding a positive recommendation to the City Council based on the Findings of Fact, Conclusions of Law, and Conditions of Approval as found in the draft ordinance.

### **Exhibits**

Exhibit A – Draft Ordinance with Proposed Plat (Attachment 1)

Exhibit B – Survey

Exhibit C – Aerial Photographs with 500' Radius & Site Photographs

Exhibit A

**Ordinance No. 18-XX**

AN ORDINANCE APPROVING THE 1304 PARK AVENUE PLAT AMENDMENT LOCATED AT 1304 PARK AVENUE, PARK CITY, UTAH.

WHEREAS, the owner of the property located at 1304 Park Avenue has petitioned the City Council for approval of the Plat Amendment; and

WHEREAS, on May 30, 2018, the property was properly noticed and posted according to the requirements of the Land Management Code; and

WHEREAS, on May 26, 2018, proper legal notice was published according to requirements of the Land Management Code and courtesy letters were sent to surrounding property owners; and

WHEREAS, the Planning Commission held a public hearing on June 13, 2018, to receive input on plat amendment; and

WHEREAS, the Planning Commission, on June 13, 2018, forwarded a \_\_\_\_\_ recommendation to the City Council; and,

WHEREAS, on July 12, 2018, the City Council held a public hearing to receive input on the plat amendment; and

WHEREAS, it is in the best interest of Park City, Utah to approve the 1304 Park Avenue Plat Amendment located at the same address.

NOW, THEREFORE BE IT ORDAINED by the City Council of Park City, Utah as follows:

**SECTION 1. APPROVAL.** The 1304 Park Avenue Plat Amendment, as shown in Attachment 1, is approved subject to the following Findings of Facts, Conclusions of Law, and Conditions of Approval:

**Findings of Fact:**

1. The property is located at 1304 Park Avenue.
2. The property consists of a metes and bounds parcel of Snyder's Addition to Park City.
3. The property is in the Historic Residential – Medium Density (HRM) District.
4. This site is listed on Park City's Historic Sites Inventory (HSI) and is designated as Landmark.
5. The Plat Amendment removes one (1) interior lot line (block line) that runs through the existing house.



6. The proposed Plat Amendment combines the metes and bounds parcel into one (1) legal lot of record, which will include 4,125 square feet.
7. The minimum lot area for a single-family dwelling is 1,875 square feet in the HRM zone. The proposed lots meet the minimum lot area for single-family dwellings.
8. A single-family dwelling is an allowed use in the District.
9. The minimum width of a Lot is 37.50 feet measured 15 feet back from the Front Lot Line. The proposed lots meet the minimum lot width requirement with width at 55 feet.
10. LMC § 15-2.4-6 indicates that historic structures that do not comply with building setbacks are valid non-complying structures.
11. The applicant proposes to maintain and renovate the historic house at 1304 Park Avenue.
12. The minimum front/rear yard setbacks are 10 feet (10'); the minimum total front plus rear yard setbacks are twenty feet (20'). The historic house is encroaching over the front property line approximately 1 foot, and is valid non-complying. There is an existing non-historic shed which has 1 foot (1') rear setback.
13. The minimum side yard setbacks for the site are five feet (5'). The house is setback 14.5 feet (14.5') from the south side yard and 4 feet (4') from the north side yard, which is valid non-complying.
14. There are several existing encroachments on site. The existing historic home, constructed in 1885, encroaches approximately 1 foot (1') over the front property line. There is an existing fence that runs along both sides and the rear property lines, which crosses over the property line into the Cottages on the Park property. There is a concrete retaining wall that encroaches 7 feet (7') into the City right-of-way in front of the 1304 Park Avenue property line (southwest corner, adjacent to the gravel driveway) and onto the Coalition Lodge Condominium property at 1300 Park Avenue.
15. The Park City Planning Department received the plat amendment application on April 19, 2017; the application was deemed complete on April 28, 2017.
16. All findings within the Analysis section and the recitals above are incorporated herein as findings of fact.

**Conclusions of Law:**

1. There is good cause for this Plat Amendment.
2. The Plat Amendment is consistent with the Park City Land Management Code and applicable State law regarding lot combinations.
3. Neither the public nor any person will be materially injured by the proposed Plat Amendment.
4. Approval of the Plat Amendment, subject to the conditions stated below, does not adversely affect the health, safety and welfare of the citizens of Park City.

**Conditions of Approval:**

1. The City Planner, City Attorney, and City Engineer will review and approve the final form and content of the plat for compliance with State law, the Land Management Code, and the conditions of approval, prior to recordation of the plat.

2. The applicant will record the plat at the County within one year from the date of City Council approval. If recordation has not occurred within one (1) years' time, this approval for the plat will be void, unless a request for an extension is made in writing prior to the expiration date and an extension is granted by the City Council.
3. Ten foot (10') public snow storage easement shall be granted along the Woodside Avenue right-of-way.
4. The fence encroaches at multiple points over the property line into the neighboring Cottages on the Park Subdivision. The applicant shall either remove the existing fence or enter into an encroachment agreement with the neighbor if the fence is to remain in its existing location.
5. The existing concrete retaining wall encroaches approximately seven feet (7') into the right-of-way. The applicant shall remove the existing retaining wall prior to recordation of this plat amendment.
6. The existing main building and front porch encroach approximately 1 foot (1') into the right-of-way. The applicant will work with the City Engineer to enter into an encroachment agreement for this structure, given the historic designation.
7. Residential fire sprinklers will be required for all new construction per the requirements of the Chief Building Official.

**SECTION 2. EFFECTIVE DATE.** This Ordinance shall take effect upon publication.

PASSED AND ADOPTED this 12th day of July, 2018.

PARK CITY MUNICIPAL CORPORATION

\_\_\_\_\_  
Andy Beerman, MAYOR

ATTEST:

\_\_\_\_\_  
City Recorder

APPROVED AS TO FORM:

\_\_\_\_\_  
Mark Harrington, City Attorney

**1304 PARK AVENUE PLAT AMENDMENT**  
 AMENDMENT TO A PORTION OF BLOCK 24  
 SUTTERS ADDITION TO PARK CITY  
 LOCATED IN THE SEVENTH EAST TOWNSHIP 2S RANGE 4E  
 SALT LAKE BASE AND MERIDIAN



**VICINITY AND ZONING MAP**  
 NOT TO SCALE

**SURVEYOR'S STATEMENT**

I, GREGORY J. FERRARI OF PARK CITY, UTAH, CERTIFY THAT I AM A REGISTERED LAND SURVEYOR UNDER THE UTAH PROFESSIONAL LAND SURVEYING ACT. I HAVE PERSONALLY CONDUCTED THE SURVEY AND THE INFORMATION CONTAINED HEREIN IS TRUE AND CORRECT. I HAVE REVIEWED THE RECORDS OF THE PLAT AMENDMENT AND THE REQUIREMENTS OF THE PLAT AMENDMENT. I DO NOT KNOW OF ANY OTHER PERSONS WHOSE INTERESTS IN THE PROPERTY ARE AFFECTED BY THIS PLAT AMENDMENT. I FURTHER CERTIFY THAT THIS PLAT ACCURATELY REPRESENTS THE SURVEYED PROPERTY.

RECORDED AT THE OFFICE OF THE COUNTY CLERK OF SALT LAKE COUNTY, UTAH, ON MARCH 31, 2017.

**OWNER'S DEDICATION AND CONSENT TO RECORD**

KNOW ALL MEN BY THESE PRESENTS THAT WE, ALL OF THE UNDERSIGNED OWNERS OF THE ABOVE DESCRIBED PROPERTY, HAVE VOLUNTARILY AND WITHOUT COERCION, UNLAWFUL INFLUENCE, OR UNLAWFUL INDUCEMENT, CONSENTED TO THE DEDICATION AND RECORDING OF THIS PLAT AMENDMENT. WE HEREBY DEDICATE FOR PERPETUAL USE OF THE PUBLIC ALL PARCELS OF LAND SHOWN ON THIS PLAT AMENDMENT. WE HAVE REVIEWED THE RECORDS OF THE PLAT AMENDMENT AND THE REQUIREMENTS OF THE PLAT AMENDMENT. WE FURTHER CERTIFY THAT THIS PLAT ACCURATELY REPRESENTS THE SURVEYED PROPERTY. IN WITNESS WHEREOF, THE UNDERSIGNED SET HIS HAND THIS \_\_\_\_\_ DAY OF \_\_\_\_\_, 2017.

**ACKNOWLEDGMENT**

STATE OF UTAH, COUNTY OF SUMMIT, 138 PERSONALLY APPEARED BEFORE ME ON THIS \_\_\_\_\_ DAY OF \_\_\_\_\_, 2017, THE FOLLOWING \_\_\_\_\_ WHO ACKNOWLEDGED TO ME THAT THEY EXECUTED THE ABOVE OWNERS DEDICATION AND CONSENT TO RECORD FREELY AND VOLUNTARILY.

**LEGAL DESCRIPTION:**

LOT 1 BEGINNING AT A POINT WHICH IS 481.00 FEET NORTH 44°01' EAST AND 500 FEET SOUTH 30°59' EAST FROM THE NORTHWEST CORNER OF BLOCK 24, SUTTERS ADDITION TO PARK CITY, UTAH; THENCE SOUTH 30°59' EAST 500 FEET; THENCE SOUTH 14°01' WEST 75.00 FEET; THENCE NORTH 14°01' WEST 75.00 FEET; THENCE NORTH 30°59' WEST 56.00 FEET TO THE POINT OF BEGINNING. CONTAINING 0.10 ACRES.

**NOTES:**

1. I HAVE REVIEWED THE RECORDS OF THE PLAT AMENDMENT AND THE REQUIREMENTS OF THE PLAT AMENDMENT. I DO NOT KNOW OF ANY OTHER PERSONS WHOSE INTERESTS IN THE PROPERTY ARE AFFECTED BY THIS PLAT AMENDMENT.
2. THIS PLAT AMENDMENT IS SUBJECT TO THE CONDITIONS OF APPROVAL OF ORDINANCE XXXXX.

- LEGEND:**
- PROPERTY LINE
  - ADJOINING PROPERTY LINE
  - CENTER LINE
  - EASEMENT
  - BLOCK LINE
  - STREET ADDRESS ON PARK AVE
  - SETBACK & NUMBER OF FEET
  - FOUND BY REBAR, A CAP, ETC.
  - STREET ENCUMBRANCE



<p><b>FERRARI SURVEYING, LLC</b>                  P.O. BOX 638909, PARK CITY, UT                  (435) 646-6412</p>	<p><b>SNYDERVILLE BASIN WATER RECLAMATION DISTRICT</b>                  REVIEWED FOR CONFORMANCE TO SNYDERVILLE BASIN WATER RECLAMATION DISTRICT STANDARDS ON THIS _____ DAY OF _____, 2017.                  BY: _____ S.E.V.C.</p>	<p><b>PLANNING COMMISSION</b>                  APPROVED BY THE PARK CITY PLANNING COMMISSION THIS 25th DAY OF MARCH, 2017.                  BY: _____ CHAIRMAN</p>	<p><b>ENGINEER'S CERTIFICATE</b>                  I FIND THIS PLAT TO BE IN ACCORDANCE WITH INFORMATION ON FILE IN MY OFFICE THIS _____ DAY OF _____, 2017 A.D.                  BY: _____ PARK CITY ENGINEER</p>	<p><b>APPROVAL AS TO FORM</b>                  APPROVED AS TO FORM THIS _____ DAY OF _____, 2017 A.D.                  BY: _____ PARK CITY ATTORNEY</p>	<p><b>CERTIFICATE OF ATTEST</b>                  I CERTIFY THIS RECORD OF PLAT AMENDMENT WAS APPROVED BY PARK CITY COUNCIL THIS 14th DAY OF APRIL, 2017 A.D.                  BY: _____ PARK CITY RECORDER</p>	<p><b>COUNCIL APPROVAL AND ACCEPTANCE</b>                  APPROVAL AND ACCEPTANCE BY THE PARK CITY COUNCIL THIS 14th DAY OF APRIL, 2017 A.D.                  BY: _____ MAYOR</p>	<p><b>RECORDED</b>                  STATE OF UTAH, COUNTY OF SUMMIT, AND FILED AT THE REQUEST OF _____ DATE _____ TIME _____ BOOK _____ PAGE _____ FEE _____ RECORDER _____</p> <p>RECEIVED APR 15 2017</p>
--	--	--	---	---	--	--	---



**RECORD OF SURVEY & TOPOGRAPHICAL MAP**  
 1304 PARK AVENUE  
 PARCEL SA-275-A, BLOCK 24 SNYDER'S ADDITION TO PARK CITY  
 LOCATED IN THE NORTHWEST QUARTER OF SECTION 16  
 TOWNSHIP 2S RANGE 4E  
 SALT LAKE BASE AND MERIDIAN

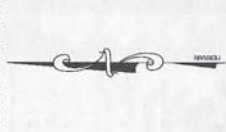

**FERRARI SURVEYING, LLC**  
 545 S. 1000 E. SUITE 100  
 PARK CITY, UT 84302  
 P.O. BOX 683001  
 PARK CITY, UT 84068

RELEASE OF DOCUMENTS  
 THE INFORMATION CONTAINED HEREIN IS THE PROPERTY OF FERRARI SURVEYING, LLC AND IS NOT TO BE REPRODUCED OR TRANSMITTED IN ANY FORM OR BY ANY MEANS, ELECTRONIC OR MECHANICAL, INCLUDING PHOTOCOPYING, RECORDING, OR BY ANY INFORMATION STORAGE AND RETRIEVAL SYSTEM WITHOUT THE WRITTEN PERMISSION OF FERRARI SURVEYING, LLC.

**RECORD OF SURVEY AND TOPOGRAPHICAL MAP**  
 BLOCK 24 SNYDER'S ADDITION TO PARK CITY  
 SA-275-A  
 JEFF VOLMURICH  
 1304 PARK AVENUE  
 PARK CITY, UTAH  
 SUMMIT COUNTY

RECEIVED  
 APR 13 2017  
 SUMMIT COUNTY RECORDERS OFFICE

SA-275-A  
 1304 PARK AVENUE  
 PARK CITY, UT 84302

DATE OF FIELD WORK: MARCH 14, 2017

DATE OF RECORDING: MARCH 31, 2017

SCALE: 1" = 10'

ZOOM COURSE: 1 OF 1

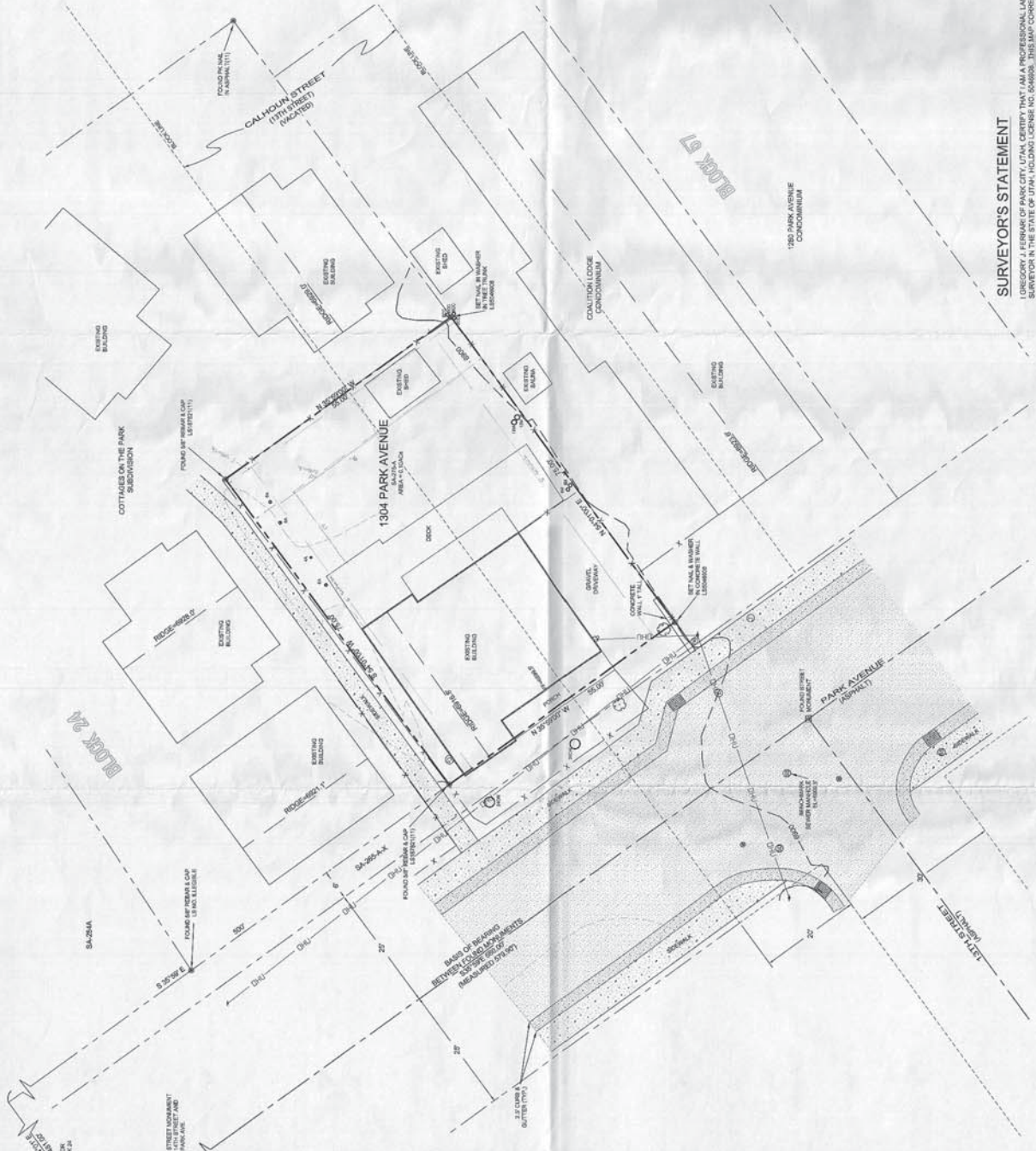

**LEGAL DESCRIPTION:**

BEGINNING AT A POINT WHICH IS 81.52 FEET NORTH 41°11' EAST AND 500 FEET SOUTH 10°11' 20" WEST FROM THE SOUTHWEST CORNER OF THE INTERSECTION OF THE EAST AND WEST LINES OF SECTION 16, TOWNSHIP 2S, RANGE 4E, SALT LAKE BASE AND MERIDIAN; THENCE SOUTH 54°11' WEST 130.00 FEET; THENCE SOUTH 20°39' EAST 55.00 FEET; THENCE NORTH 54°11' WEST 130.00 FEET; THENCE SOUTH 10°11' 20" EAST 50.00 FEET; THENCE NORTH 54°11' WEST 130.00 FEET TO THE POINT OF BEGINNING.

**LEGEND:**

- CLIENT PROPERTY LINE
- - - ADJOINING PROPERTY LINE
- WATER VALVE
- TELEPHONE MANHOLE
- ELECTRIC MANHOLE
- POWER POLE
- ELECTRIC METER
- GAS METER
- GAS VALVE
- FIRE HYDRANT
- FIRE HYDRANT
- CENTERLINE
- MAJOR CONTOUR
- FENCE
- PUBLIC UTILITY EASEMENT
- BLOCKLINE
- OVER HEAD UTILITY
- LEAD BUSH
- O.A.
- FLOW
- TREE TRUNK
- DAM
- ASPEN
- COTTONWOOD
- MAPLE
- PINE
- CHERRY

**PROJECT INFORMATION:**

CLIENT: JEFF VOLMURICH  
 2005 EAST STANLEY DRIVE  
 PARK CITY, UT 84302  
 PROJECT ADDRESS: 1304 PARK AVENUE  
 PARK CITY, UT 84302  
 SERIAL NO.: SA-275-A

**NOTES:**

1. THE PURPOSE OF THIS SURVEY IS TO LOCATE THE BOUNDARIES OF THIS PROPERTY ON THE GROUND AND CREATE A TOPOGRAPHICAL MAP AT THE REQUEST OF JEFF VOLMURICH.
2. THE EVIDENCE OF BOUNDARY SHOWN HEREON IS TAKEN FROM RECORD INFORMATION COMPILED PREVIOUSLY BY THE SURVEYOR AND FROM FIELD MEASUREMENTS.
3. NO INVESTIGATION CONCERNING ENVIRONMENTAL AND SUBSURFACE CONDITIONS OR THE EXISTENCE OF ADEQUATE FOUNDATION OR CONTAMINATING MATERIALS WHICH MAY AFFECT THE USE OR ENJOYMENT OF THIS PROPERTY WAS MADE AS A PART OF THIS SURVEY.
4. NO INVESTIGATION CONCERNING THE LOCATION OF OR EXISTENCE OF UTILITY SERVICE LINES TO THIS PROPERTY WAS MADE AS A PART OF THIS SURVEY.
5. ALL UTILITY LOCATIONS SHOULD BE FIELD VERIFIED PRIOR TO ANY DESIGN OR CONSTRUCTION.
6. DATE OF FIELD WORK: MARCH 14, 2017.
7. VERTICAL DATUM IS ASSUMED.
8. BUILDING SETBACKS MUST BE CONFIRMED WITH THE COUNTY, HOMEOWNERS ASSOCIATION, ARCHITECTURAL COMMITTEE, OR SIMILAR AUTHORITY GROUP, IF ANY.
9. THE OWNER OF THE PROPERTY SHOULD BE AWARE OF ANY ITEMS AFFECTING THE PROPERTY THAT MAY APPEAR IN A TITLE INSURANCE REPORT.
10. BASIS OF BEARING SHOWN HEREON.
11. FOUND REE BAR SURVEYON P. AT 25' COTTAGES ON THE PARK ENTRY NO. 330081 ON FILE AT THE OFFICE OF THE SUMMIT COUNTY RECORDER.

**SURVEYOR'S STATEMENT**

I, GREGORY J. FERRARI OF PARK CITY, UTAH, CERTIFY THAT I AM A PROFESSIONAL LAND SURVEYOR IN THE STATE OF UTAH, HOLDING LICENSE NO. 66889. THIS MAP CORRECTLY REPRESENTS THE SURVEYED AND CALCULATED BOUNDARIES OF THE PROPERTY AND THAT TO THE BEST OF MY KNOWLEDGE IT IS A CORRECT REPRESENTATION OF THE LAND SURVEYED.

GREGORY J. FERRARI, P.L.S., SURVEYOR  
 MARCH 31, 2017











## Planning Commission Staff Report

**Subject:** King's Crown  
**Author:** Francisco Astorga, AICP, Senior Planner  
**Project #:** PL-17-03515  
**Date:** 13 June 2018  
**Type of Item:** Administrative – Ratification of Development Agreement

### Summary Recommendations

Staff recommends that the Planning Commission review the King's Crown Master Planned Development (MPD) Development Agreement (DA) and consider ratifying the agreement to memorialize the MPD approval granted by the Planning Commission on January 10, 2018. A public hearing is not required for this action.

### Description

**Applicant:** CRH Partners, LLC represented by Rory Murphy, Hans Fuegi, and Chuck Heath  
**Location:** 1201-1299 Lowell Avenue, Park City, Utah 84060  
**Zoning:** Recreation Commercial (RC) District, Recreation And Open Space (ROS) District, and Sensitive Land Overlay (SLO) Zone  
**Adjacent Land Uses:** Trails, skiing, open space, and residential.  
**Reason for Review:** MPDs require a Development Agreement with ratification by the Planning Commission.

### Background - Development Agreement Ratification

Land Management Code (LMC) § 15-6-4 (G) states that once the Planning Commission has approved a MPD, the approval shall be put in the form of a Development Agreement (DA). The DA must be ratified by the Planning Commission and signed by the Mayor on behalf of the City Council, prior to recordation at the Summit County Recorder's office.

The LMC requires the DA to be submitted to the City within six (6) months of the approval of the MPD. The King's Crown MPD was approved by the Planning Commission on January 10, 2018. The proposed DA was submitted to the City on March 18, 2018, within the required six (6) month timeframe. The applicant has been working with staff as redlines (edits, comments, questions, etc.) have been provided by the City and the applicant has responded to such edits, comments, questions, etc. A final version was submitted by the City on May 30, 2018, also within the required six (6) month timeframe.

### Background – Approved Master Plan Development

**MPD application** - Any residential project with ten (10) or more lots or ten or more residential unit equivalents (20,000 square feet) requires an MPD. The applicant

proposes the construction of thirty (30) units totaling 80,963 square feet within three (3) separate multi-unit dwellings, fifteen (15) deed-restricted affordable housing units totaling 16,520 square feet in a separate multi-unit dwelling, and twenty-seven (27) single-family dwelling lots equating to approximately 71,880 square feet. The applicant requests a total of 57 residential units (condos/townhouses/houses) totaling approximately 152,843 square feet. This MPD was approved by the Planning Commission on January 10, 2018.

**CUP application** - Multi-unit dwellings are listed as a conditional use in the RC District. The applicant proposes the construction of four (4) multi-unit dwelling buildings which includes one (1) building housing the affordable housing units that exceeds the required affordable housing requirements. MPDs are also listed as conditional uses within the RC District. This CUP was approved by the Planning Commission on January 10, 2018.

**Re-Subdivision application** - The reconfiguring of the proposed lots require final action of a Re-Subdivision by the City Council. The applicant proposes a total of 32 lots of record from the existing 247 lots platted Old Town lots, within Snyder's Addition to the Park City Survey. Applicant proposes the following:

- Three (3) lots to accommodate the four (4) Multi-Unit Dwelling buildings (to be later re-plated via Condominium Plat): proposed Lot 1, 2, and 30.
- Twenty-seven (27) single-family dwelling lots: proposed Lot 3 - 29.
- Two (2) open space lots: proposed Lot 31 - 32.

This Re-Subdivision was approved by the City Council on February 23, 2018.

The subject site is located at 1201 – 1299 Lowell Avenue. The subject site is within the RC, ROS, and SLO District. The proposed development takes place roughly over 30% of the property, all contained within the RC District located adjacent to Lowell Avenue towards the northeast of the subject site. No units are proposed within the ROS District or within the SLO.

The applicant proposes to build three (3) multi-unit buildings with access off Lowell Avenue, a private road/drive to be known as Rothwell Road, and a townhouse building with access off Rothwell Road. The proposed private road/drive begins at the 12<sup>th</sup> Street / Lowell Avenue intersection which then curbs up to a hammer-head turn around located near the northwest corner of the property. Rothwell Road climbs up approximately sixty feet (60') and is approximately 548 feet long.

The applicant also proposes to develop 27 single-family lots, 4 of which would be accessed off Lowell Avenue, and the remaining 24 would be accessed off Rothwell Road (15 on the west side of the private road and 8 on the east side of the private road). The applicant does not plan on building the 27 houses, but to develop the lots to be able to sell them individually.

The MPD includes the following:

- A total of 32 lots.

- Seven (7) deed restricted affordable housing condominium units (8.55 affordable unit equivalents).
- Eight (8) additional non-required deed restricted affordable housing condominium units (9.07 affordable unit equivalents).
- 11.2 acres of platted open space in the form of large tracts of contiguous natural open space that does not include open space area around the units, equating to 74.6%. The total open space percentage is 83.9.
- Market rate units
  - 23 condominiums
  - 7 townhomes
  - 27 single-family lots (detached houses)

#### Building A - Affordable Housing

- Multi-unit dwelling, conditional use
- 15 residential affordable housing units
- Square footage
  - Residential: 16,520
  - Mechanical: 256
  - Internal circulation (hallways and stairs): 1,833
  - Parking and vehicular circulation: 5,571
  - Overall: 24,180
- 18 parking spaces located in an enclosed underground parking garage
- Vehicular access off Lowell Avenue through one (1) driveway
- 5 stories above the parking garage
- Located on proposed Lot 1
- Affordable housing residential units do not count towards residential Unit Equivalents

#### Building B/C

- Multi-unit dwelling, conditional use
- 12 residential units
- Square footage
  - Residential: 28,253 (14.13 residential Unit Equivalents)
  - Mechanical: 375
  - Internal circulation (hallways, stairs, and elevator): 1,133
  - Parking and vehicular circulation: 9,305
  - Overall: 39,066
- 21 parking spaces located in enclosed underground parking garages
- Vehicular access off Lowell Avenue through two (2) separate driveways
- 4 stories above the parking garage
- Located on proposed Lot 2

#### Building D

- Multi-unit dwelling, conditional use
- 11 residential units



- Square footage
  - Residential: 24,590 (12.30 residential Unit Equivalents)
  - Mechanical: 166
  - Internal circulation (hallways, stairs, and elevator): 1,827
  - Parking and vehicular circulation: 8,313
  - Overall: 34,896
- 22 parking spaces located in an enclosed underground parking garage
- Vehicular access off Lowell Avenue through one (1) driveway
- 4 stories above the parking garage
- Located on proposed Lot 2

#### Townhomes Building

- Multi-unit dwelling, conditional use
- 7 residential units
- Residential square footage: 29,005 (14.50 residential Unit Equivalents)
- 14 parking spaces, 2 within each parking garage
- Vehicular access off proposed private drive through individual driveways
- 3 stories above the garage level
- Located on proposed Lot 30

#### Single-Family Residential Lots

- Single-family dwellings, allowed use
- 27 lots accommodate one (1) single-family dwelling on each lot
- Approximate buildable square footage: 71,880 (35.94 residential Unit Equivalents)
- 54 parking spaces, 2 within each lot as required
- Vehicular access off proposed private drive through individual driveways
- Located on proposed Lots 3-29

#### Open Space Lots

- 2 lots to be re-platted as open space
- Proposed open space lot 31:
  - Square footage: 2,106.4
  - Proposed retaining walls and stair access to adjacent property to the south
- Proposed open space Lot 32:
  - Square footage: 487,798.29 (11.2 acres)
  - No improvements on this lot
  - Proposed accessory building, 750 square feet, consisting of restroom and lockers for the exclusive use of property owners. Accessory buildings are an allowed use with the RC District. Restrooms/lockers are considered residential accessory space and do not count towards Unit Equivalents.
  - Contains an existing pedestrian access easement for Nastar, LLC.

## **Development Agreement Requirements**

LMC § 15-6-4 (G) indicates the following:

***DEVELOPMENT AGREEMENT.*** *Once the Planning Commission has approved the Master Planned Development, the approval shall be put in the form of a Development Agreement. The Development Agreement shall be in a form approved by the City Attorney, and shall contain, at a minimum, the following:*

- 1. A legal description of the land;*
- 2. All relevant zoning parameters including all findings, conclusions and conditions of approval;*
- 3. An express reservation of the future legislative power and zoning authority of the City;*
- 4. A copy of the approved Site plan, architectural plans, landscape plans, Grading plan, trails and open space plans, and other plans, which are a part of the Planning Commission approval;*
- 5. A description of all Developer exactions or agreed upon public dedications;*
- 6. The Developers agreement to pay all specified impact fees; and*
- 7. The form of ownership anticipated for the project and a specific project phasing plan.*
- 8. A list and map of all known Physical Mine Hazards on the property, as determined through the exercise of reasonable due diligence by the Owner, as well as a description and GPS coordinates of those Physical Mine Hazards.*
- 9. A map and inventory of all Historic Structures on the Property and a Historic Structures Report prepared by a qualified Historic Preservation Professional.*

*The Development Agreement shall be ratified by the Planning Commission, signed by the City Council and the Applicant, and recorded with the Summit County Recorder. The Development Agreement shall contain language, which allows for minor, administrative modifications to occur to the approval without revision of the agreement. The Development Agreement must be submitted to the City within six (6) months of the date the project was approved by the Planning Commission, or the Planning Commission approval shall expire.*

Staff finds that the proposed DA, Attachment 1, includes all of the required items listed above and meets the required timeframes for submittal following the January 10, 2018 approval of the King's Crown MPD.

### **Department Review**

The Legal and Planning Departments have reviewed the agreement for conformance with the July 10, 2018, King's Crown MPD approval.

### **Summary Recommendations**

Staff recommends that the Planning Commission review the King's Crown Master Planned Development (MPD) Development Agreement (DA) and consider ratifying the agreement to memorialize the MPD approval granted by the Planning Commission on January 10, 2018. A public hearing is not required for this action.

## **Attachments**

Attachment 1 – Proposed DA including Exhibit B MPD Approval Letter  
Attachment 2 – Ordinance No. 2018-05 (approving the Re-Subdivision)  
Attachment 3 – MPD General Construction Mitigation Plan Letter & Exhibits

## **Link - Applicant Narratives**

[Exhibit A - Applicant's MPD Letter](#)  
[Exhibit B - Applicant's General Plan Letter](#)  
[Exhibit C - Prior Agreements](#)  
[Exhibit D - Applicant's CUP Letter](#)  
[Exhibit E - Applicant's Re-Subdivision Letter](#)  
[Exhibit F - Construction Mitigation Plan](#)  
[Exhibit G – Affordable Housing Letter](#)  
[Exhibit H – 2017.08.03 Planning Commission and Staff Questions and Concerns Letter](#)  
[Exhibit I – 2017.12.01 Planning Commission Response Letter \(submitted on 2017.12.06\)](#)

## **Link - Reports**

[Exhibit J - Applicant's Traffic Studies and Transportation Master Plan](#)  
[Exhibit K - Vegetation Study](#)  
[Exhibit L - Geotechnical Investigation](#)  
[Exhibit M - City Traffic Study](#)  
[Exhibit N - King's Crown Traffic Study](#)  
[Exhibit O - Cultural Survey](#)  
[Exhibit P - Environmental Survey](#)  
[Exhibit Q - Mine Site Studies](#)  
[Exhibit R - Proposed Export Fill Placement Exhibit and Possible Fill Locations](#)  
[Exhibit S - SFD Approximate Excavation Quantities](#)

## **Link - Plans**

[Exhibit T - General Drawings:](#)  
[Exhibit U1 – Civil Drawings \(ALTA & Slope\):](#)  
[Exhibit U2 – Proposed Plat \(updated\)](#)  
[Exhibit U3 – Survey](#)  
[Exhibit U4 - Civil Drawings:](#)  
[Exhibit V – Landscape Drawings:](#)  
[Exhibit W - Architectural Site Drawings:](#)  
[Exhibit X - Site Compliance Drawings:](#)  
[Exhibit Y - Architectural Graphics Drawings:](#)  
[Exhibit Z - Architectural Drawings:](#)  
Exhibit AA – Materials  
[Material Board](#)  
[Townhome Rendering](#)

WHEN RECORDED, MAIL TO:  
City Recorder  
Park City Municipal Corporation  
P. O. Box 1480  
Park City, Utah 84060

**DEVELOPMENT AGREEMENT  
FOR THE KING’S CROWN MASTER PLANNED DEVELOPMENT (MPD),  
LOCATED AT 1201-1299 LOWELL AVENUE, PARK CITY,  
SUMMIT COUNTY, UTAH**

This Development Agreement (this “Agreement”) is entered into as of this \_\_\_\_ day of May, 2018, by and between CRH Partners, LLC, a Utah limited liability company (“Developer”), as the owner and developer of certain real property located in Park City, Summit County, Utah, on which Developer proposes the development of a project known as the King’s Crown Master Planned Development, and Park City Municipal Corporation, a municipality and political subdivision of the State of Utah (“Park City”), by and through its City Council.

**RECITALS**

A. Developer is the owner of a 15.01-acre parcel of real property located at 1201-1299 Lowell Avenue in Park City, Summit County, Utah, the legal description of which is attached hereto as **Exhibit A**, and incorporated herein by this reference (the “Property”), for which the Developer has obtained Master Planned Development approval, pursuant to Application Number PL-17-03515, and Conditional Use Permit approval pursuant to Application Number PL-17-03566 for the development known as King’s Crown Master Planned Development (the “Project”), as more fully described in and subject to the Findings of Fact, Conclusions of Law and Conditions of Approval adopted by the Planning Commission on January 10, 2018, and as set forth in the Approval Letter from Park City dated January 22, 2018, a copy of which is attached hereto as Exhibit B and incorporated herein by this reference (collectively referred to herein as the “MPD Approval Letter”).

B. Park City requires development agreements under the requirements of the Park City Land Management Code (“LMC”) for all Master Planned Developments.

C. Developer is willing to design and develop the Project in a manner that is in harmony with and intended to promote the long-range policies, goals and objectives of the Park City General Plan, and address other issues as more fully set forth below.

D. Park City, acting pursuant to its authority under Utah Code Ann., Section 10-9-101, et seq., and in furtherance of its land use policies, goals, objectives, ordinances, resolutions, and regulations, has made certain determinations with respect to the proposed Project, and, in the exercise of its legislative discretion, has elected to approve this Development Agreement.

Now, therefore, in consideration of the mutual covenants, conditions and considerations as more fully set forth below, Developer and Park City hereby agree as follows:



**1. Property.**

The King’s Crown Master Planned Development Property is a 15.01-acre parcel of real property located directly adjacent to the Park City Resort (the “Resort”), and the King’s Crown ski run cuts through the Property on its western boundary. The Property is zoned RC District (4.59 acres), RC District within the SLO Zone (1.81 acres), ROS District (1.93 acres) and ROS District within the SLO Zone (6.68 acres).

**2. Project Conditions.**

2.1. The MPD Approval Letter, as approved by the Planning Commission on January 10, 2018, is attached hereto as **Exhibit B** and is incorporated herein as the Project, subject to any changes detailed herein.

2.2. In connection with Developer’s application to Park City for Master Planned Development Approval and Conditional Use Permit approval for the Project, Developer submitted to the Planning Commission certain reports, plans and drawings. Attached to this Agreement and incorporated herein by this reference are copies of the following reports, plans and drawings that were submitted by Developer to Park City:

- Exhibit A -** Exhibit A – Legal Description of the Property
- Exhibit B -** Exhibit B – King’s Crown Master Planned Development and Conditional Use Permit Approval Letter approved by the Planning Commission on January 10, 2018
- Exhibit C -** Cultural Survey
- Exhibit D -** Mine Site Studies
- Exhibit E -** Proposed Export Fill Placement Exhibit and Possible Fill Locations
- Exhibit F -** SFD Approximate Excavation Quantities
- Exhibit G -** General Drawings
- Exhibit H -** Civil Drawings (ALTA & Slope)
- Exhibit I -** Proposed Plat (updated)
- Exhibit J -** Survey
- Exhibit K -** Civil Drawings
- Exhibit L -** Landscape Drawings
- Exhibit M -** Architectural Site Drawings
- Exhibit N -** Site Compliance Drawings
- Exhibit O -** Architectural Graphics Drawings
- Exhibit P -** Architectural Drawings
- Exhibit Q -** Material Board
- Exhibit R -** Townhome Rendering
- Exhibit S -** Environmental Survey
- Exhibit T -** Open Space Use Plan
- Exhibit U -** Trails Master Plan
- Exhibit V -** Construction Mitigation Plan

## Attachment 1 – Proposed Development Agreement

2.3. As required by Conditions of Approval number 18 on page 11 of the MPD Approval Letter, an open space use plan (the “Open Space Use Plan”) that has been approved by Developer and the Park City Planning Department is attached hereto as **Exhibit T** and is incorporated herein by this reference.

2.4. As required by Conditions of Approval number 19 on page 11 of the MPD Approval Letter, a trails master plan (the “Trails Master Plan”) that has been approved by Developer and the Park City Planning Department is attached hereto as **Exhibit U** and is incorporated herein by this reference.

2.5. As required by Conditions of Approval number 2 on page 10 of the MPD Approval Letter, a construction mitigation plan (the “Construction Mitigation Plan”) that has been delivered by Developer to the Park City Planning Department is attached here to **Exhibit V** and is incorporated herein by this reference.

2.6. Developer and its successors agree to pay the then current impact fees imposed and as uniformly established by the Park City Municipal Code at the time of permit application, whether or not state statutes regarding such fees are amended in the future.

2.7. Developer and any successors agree that the following are required to be entered into and approved by Park City prior to the issuance of any building permits for the Project: (a) a construction mitigation plan, (b) utility plans, (c) a storm water run-off and drainage plan, (d) an affordable housing plan, and (e) a water efficient landscape and irrigation plan showing storm water facilities and snow storage areas.

2.8. Developer shall be responsible for compliance with all requirements and conditions of the Snyderville Basin Water Reclamation District prior to the issuance of any building permits for the Project.

2.9. Developer is responsible for compliance with all local, state, and federal regulations regarding contaminated soils as well as streams and wetlands. Developer is responsible for receiving any Army Corp of Engineer Permits required related to disturbance of streams and wetlands.

2.10. Developer caused to be prepared an environmental survey (the “Environmental Survey”), a copy of which is attached hereto as **Exhibit S**. The Environmental Survey revealed that there were no environmental contaminants on the Property.

2.11. Developer caused to be prepared certain mine site studies (the “Mine Site Studies”), copies of which are attached hereto as Exhibit D. The Mine Site Studies reveal that there were no mining related activities conducted in the past on the Property.

### **3. Developer Exactions/Public Dedications.**

Along the portion of the Project that abuts and is contiguous to Lowell Avenue, Developer shall be obligated to construct and dedicate to Park City a public sidewalk that is constructed in compliance with the construction standards and specifications of Park City for a public sidewalk. In addition, Developer shall be obligated to grant a perpetual, nonexclusive easement for public

pedestrian and bicycle access through the private road identified on the Plat as Rothwell Road and through the open space trails within the Project as identified on the Plat.

**4. Vested Rights and Reserved Legislative Powers.**

4.1. Subject to the provisions of this Agreement, Developer shall have the right to develop and construct the Project in accordance with the uses, densities, intensities, and general configuration of development approved by this Agreement, subject to compliance with the other applicable ordinances and regulations of Park City.

4.2. Reserved Legislative Powers. Developer acknowledges that Park City is restricted in its authority to limit its police power by contract and that the limitations, reservations and exceptions set forth herein are intended to reserve to Park City all of its police power that cannot be so limited. Notwithstanding the retained power of Park City to enact such legislation under the police powers, such legislation shall only be applied to modify the existing land use and zoning regulations which are applicable to the Project under the terms of this Agreement based upon policies, facts and circumstances meeting the compelling, countervailing public interest exception to the vested rights doctrine in the State of Utah. Any such proposed legislative changes affecting the Project and terms and conditions of this Agreement applicable to the Project shall be of general application to all development activity in Park City; and, unless Park City declares an emergency, Developer shall be entitled to the required notice and an opportunity to be heard with respect to the proposed change and its applicability to the Project under the compelling, countervailing public interest exception to the vested rights doctrine.

**5. Successors and Assigns.**

5.1. Binding Effect. This Agreement shall be binding on the successors and assigns of Developer in the ownership or development of any portion of the Project.

5.2. Assignment. Neither this Agreement nor any of the provisions, terms or conditions hereof can be assigned to any other party, individual or entity without assigning the rights as well as the responsibilities under this Agreement and without the prior written consent of Park City, which consent shall not be unreasonably withheld. Any such request for assignment may be made by letter addressed to Park City, and the prior written consent of Park City may also be evidenced by letter from Park City to Developer or its successors or assigns. This restriction on assignment is not intended to prohibit or impede the sale of parcels of fully or partially improved or unimproved land by Developer prior to construction of buildings or improvements on the parcels, with Developer retaining all rights and responsibilities under this Agreement.

**6. Phasing and Form of Ownership.**

6.1. Project Phasing. The Project shall be developed in three (3) phases. Following the recording in the Office of the Recorder of Summit County, Utah of the subdivision plat (“the Plat”) that has been approved by Park City for the Project, the first phase of the Project shall include the construction and completion by Developer of Rothwell Road, Building A, which is the affordable housing building, and the ski access and the associated ski facility and infrastructure, all as shown on the Plat. As a condition precedent to Park City issuing a certificate of occupancy for any market rate unit within the Project, Park City shall be provided with proof of the construction and

completion by Developer of Rothwell Road. The second phase of the Project shall be commenced and shall proceed: (a) based on the local real estate sales market acceptance for the market rate condominium units, and (b) based on the ability of Developer to obtain the requisite construction financing. Developer shall cause to be constructed during the second phase the 23 market rate condominium units in Building B, C, D within Lot 2 and the 7 market rate condominium units within Lot 30. The second phase of the Project may be commenced prior to the completion by Developer of the first phase of the Project, but as stated above Park City shall not issue a certificate of occupancy for any market rate unit within the Project in either the second phase or the third phase until Park City shall be provided with proof of the construction and completion by Developer of Rothwell Road and Building A, which is the affordable housing building. The third phase of the Project shall consist of the improvement and sale of the 27 market rate single-family lots, which Developer anticipates to be an on-going effort that may take several years to complete the sale of all such 27 single-family lots. The third phase of the Project may be commenced prior to the completion by Developer of the first phase and the second phase of the Project, but as stated above Park City shall not issue a certificate of occupancy for any market rate unit within the Project in either the second phase or the third phase until Park City shall be provided with proof of the construction and completion by Developer of Rothwell Road and Building A, which is the affordable housing building.

6.2. Form of Ownership Anticipated for the Project. The Project will consist of up to 27 market rate single-family lots, 30 market rate condominium units, 7 deed-restricted affordable housing condominium units and 8 additional non-required deed-restricted affordable housing condominium units, all of which shall be available for individual ownership.

**7. Water.**

Developer acknowledges that water development fees will be collected by Park City in the same manner and in the same comparative amounts as with other developments within the municipal boundaries and that impact fees so collected will not be refunded to Developer or to individual building permit applicants developing within the Project.

**8. Affordable Housing.**

As required by the Conditions of Approval number 8 on page 10 of the MPD Approval Letter, an Affordable Housing Plan for the Project shall be approved by the Park City Housing Authority prior to the issuance of any building permits for units within the Project, and deed restrictions pertaining to the Affordable Housing Plan shall be recorded. As required by the Conditions of Approval number 9 on page 10 of the MPD Approval Letter, as a condition precedent to receiving a certificate of occupancy for any market rate unit within the Project, Park City shall be provided with proof of compliance with the approved Affordable Housing Plan.

**9. Physical Mine Hazards.**

There are no known Physical Mine Hazards on the property as determined through the exercise of reasonable due diligence by the Developer.



**10. Historic Structures.**

10.1. The Cultural Survey attached to this Agreement as **Exhibit C** reveals that located within the boundaries of the Project is a significant historical element referred to as the Crescent Tramway. The Crescent Tramway is an old dirt road that his currently used as a public trail for pedestrian use and for biking. The Crescent Tramway is not a structural object. The location of the Crescent Tramway is shown on the Trails Master Plan attached to this Agreement as Exhibit T. The Crescent Tramway will continue to be made available for use as a public trail for pedestrians and for biking. Developer also intends to use a portion of the Crescent Tramway as skiing access from the residential structures developed within the Project to the ski runs that are adjacent to the Project.

**11. General Terms and Conditions.**

11.1. Term of Agreement. Construction, as defined by the Uniform Building Code, is required to commence within two (2) years of the date of execution of this Agreement. After construction commences, the King’s Crown Master Planned Development and this Agreement shall continue in force and effect until all obligations hereto have been satisfied. The MPD approval and CUP approval for the Project, as set forth in the MPD Approval Letter, shall remain valid so long as construction is proceeding in accordance with the approved phasing plan set forth herein.

11.2. Agreement to Run With the Land. This Agreement shall be recorded against the Property, as described in Exhibit A attached hereto, and shall be deemed to run with the land and shall be binding on all successors and assigns of Developer in the ownership or development of any portion of the Property.

11.3. No Joint Venture, Partnership or Third Party Rights. This Agreement does not create any joint venture, partnership, undertaking, or business arrangement between the parties hereto, nor any rights or benefits to third parties.

11.4. Integration. This Agreement contains the entire agreement with respect to the subject matter hereof and integrates all prior conversations, discussions, or understandings of whatever kind or nature and may only be modified by a subsequent writing duly executed by the parties hereto.

11.5. Severability. If any part or provision of this Agreement shall be determined to be unconstitutional, invalid or unenforceable by a court of competent jurisdiction, then such a decision shall not affect any other part or provision of this Agreement except that specific provision determined to be unconstitutional, invalid, or unenforceable. If any condition, covenant, or other provision of this Agreement shall be deemed invalid due its scope or breadth, such provision shall be deemed valid to the extent of the scope or breadth permitted by law.

11.6. Attorneys’ Fees. If this Agreement or any of the Exhibits hereto are breached, the party at fault agrees to pay the attorneys’ fees and all costs of enforcement of the non-breaching party.

11.7. Minor Administrative Modification. Minor administrative modifications may occur to the MPD Approval Letter without revision of this Agreement.

**12. Notices.**

All notices, requests, demands, and other communications hereunder shall be in writing and shall be given (i) by Federal Express, UPS, or other established express delivery service which maintains delivery records, (ii) by hand delivery, or (iii) by certified or registered mail, postage prepaid, return receipt requested, to the parties at the following addresses, or at such other address as the parties may designate by written notice in the above manner:

To Developer:

CRH Partners, LLC  
1887 Gold Dust Lane, Suite 301  
Park City, UT 84060  
Attn: Hans Fuegi

To Park City:

Park City Municipal Corporation  
445 Marsac Avenue  
PO Box 1480  
Park City, UT 84060  
Attn: City Attorney

Such communication may also be given by facsimile and/or email transmission, provided any such communication is concurrently given by one of the above methods. Notices shall be deemed effective upon receipt, or upon attempted delivery thereof if delivery is refused by the intended recipient or if delivery is impossible because the intended recipient has failed to provide a reasonable means for accomplishing delivery.

*The rest of this page is left intentionally blank.*

**13. List of Exhibits.**

- Exhibit A – Legal Description of the Property
- Exhibit B – King’s Crown Master Planned Development and Conditional Use Permit Approval  
Letter approved by the Planning Commission on January 10, 2018
- Exhibit C – Cultural Survey
- Exhibit D – Mine Site Studies
- Exhibit E – Proposed Export Fill  
Placement Exhibit and Possible  
Fill Locations
- Exhibit F – SFD Approximate Excavation Quantities
- Exhibit G – General Drawings
- Exhibit H – Civil Drawings (ALTA & Slope)
- Exhibit I – Proposed Plat (updated)
- Exhibit J – Survey
- Exhibit K – Civil Drawings
- Exhibit L – Landscape Drawings
- Exhibit M – Architectural Site Drawings
- Exhibit N – Site Compliance Drawings
- Exhibit O – Architectural Graphics Drawings
- Exhibit P – Architectural Drawings
- Exhibit Q – Material Board
- Exhibit R – Townhome Rendering
- Exhibit S – Environmental Study
- Exhibit T – Open Space Use Plan
- Exhibit U – Trails Master Plan
- Exhibit V – Construction Mitigation Plan

*The rest of this page is left intentionally blank.*

**IN WITNESS WHEREOF**, this Agreement has been executed by the Developer by persons duly authorized to execute the same and by the city of Park City, acting by and through its City Council as of the \_\_\_ day of \_\_\_\_\_, 2018.

**PARK CITY MUNICIPAL CORPORATION**

By: \_\_\_\_\_  
Mayor

ATTEST:

By: \_\_\_\_\_  
City Recorder

APPROVED AS TO FORM:

\_\_\_\_\_

**DEVELOPER:**

**CRH PARTNERS, LLC,**  
a Utah limited liability company

By: \_\_\_\_\_  
Name: \_\_\_\_\_  
Title: \_\_\_\_\_

**STATE OF UTAH**            )  
                                      : ss.  
**COUNTY OF SUMMIT**    )

On this \_\_\_ day of \_\_\_\_\_, 2018, personally appeared before me \_\_\_\_\_, whose identity is personally known to me/or proved to me on the basis of satisfactory evidence and who by me duly sworn/affirmed), did say that he is a member/manager of CRH Partners, LLC, a Utah limited liability company.

\_\_\_\_\_  
Notary Public  
Residing at: \_\_\_\_\_

**EXHIBIT A**

**LEGAL DESCRIPTION OF THE PROPERTY**

BEGINNING AT THE INTERSECTION OF THE CENTERLINE OF VACATED 13TH STREET (A.K.A. CALHOUN STREET), AND THE WESTERLY LINE OF SNYDER'S ADDITION TO PARK CITY. SAID WESTERLY LINE OF SNYDER'S ADDITION TO PARK CITY IS ALSO THE NORTH-SOUTH 1/16 SECTION LINE (WEST LINE OF THE SOUTHEAST QUARTER OF THE NORTHWEST QUARTER) OF SECTION 16, TOWNSHIP 2 SOUTH, RANGE 4 EAST, SALT LAKE BASE AND MERIDIAN. SAID POINT ALSO LYING ON THE SOUTHERLY BOUNDARY LINE OF MOUNTAINSIDE CONDOMINIUMS PHASE 2, ON FILE AND OF RECORD IN THE OFFICE OF THE SUMMIT COUNTY RECORDER. SAID POINT OF BEGINNING IS LOCATED SOUTH 00° 31' 00" WEST, 1192.35 FEET ALONG THE WEST LINE OF THE NORTHEAST QUARTER OF THE NORTHWEST QUARTER OF SECTION 16, TOWNSHIP 2 SOUTH, RANGE 4 EAST, SALT LAKE BASE AND MERIDIAN; THENCE NORTH 54°01'00" EAST ALONG SAID SOUTHERLY BOUNDARY LINE OF MOUNTAINSIDE CONDOMINIUMS PHASE 2, 236.70 FEET TO A POINT ON THE WESTERLY RIGHT OF WAY LINE OF LOWELL AVENUE; THENCE SOUTH 35°59'00" EAST ALONG SAID WESTERLY RIGHT OF LINE OF LOWELL AVENUE, 595.00 FEET TO THE SOUTHERLY RIGHT OF WAY LINE OF VACATED 12TH STREET (A.K.A. NELSON STREET); THENCE LEAVING SAID WESTERLY RIGHT OF WAY LINE OF LOWELL AVENUE, SOUTH 54°01'00" WEST, 140.00 FEET; THENCE SOUTH 35°59'00" EAST, 400.00 FEET TO THE SOUTHWEST CORNER OF BARBARA'S SUBDIVISION, ON FILE AND OF RECORD IN THE OFFICE OF THE SUMMIT COUNTY RECORDER, SAID POINT ALSO BEING ON THE NORTHERLY BOUNDARY LINE OF NORTHSTAR SUBDIVISION, ON FILE AND OF RECORD IN THE OFFICE OF THE SUMMIT COUNTY RECORDER; THENCE SOUTH 54°01'00" WEST ALONG SAID NORTHERLY BOUNDARY LINE, 235.00 FEET TO THE NORTHWEST CORNER OF SAID NORTHSTAR SUBDIVISION; THENCE SOUTH 35°59'00" EAST ALONG THE WESTERLY BOUNDARY LINE OF SAID NORTHSTAR SUBDIVISION, 675.15 FEET TO THE SOUTHWEST CORNER OF SAID NORTHSTAR SUBDIVISION, SAID POINT ALSO BEING ON THE EAST-WEST CENTER SECTION LINE (SOUTH LINE OF THE NORTHWEST QUARTER) OF SECTION 16, TOWNSHIP 2 SOUTH, RANGE 4 EAST, SALT LAKE BASE AND MERIDIAN; THENCE SOUTH 89°53'05" WEST ALONG SAID EAST-WEST CENTER SECTION LINE, 493.60 FEET TO THE CENTERLINE OF VACATED SUMMIT AVENUE; THENCE NORTH 35°59'00" WEST ALONG SAID CENTERLINE OF SUMMIT AVENUE, 346.25 FEET, MORE OR LESS, TO THE EASTERLY EDGE OF THE EXISTING KING'S CROWN SKI RUN; THENCE NORTH 13°14'53" WEST ALONG SAID EASTERLY EDGE OF THE KING'S CROWN SKI RUN, 26.76 FEET TO THE CENTERLINE OF VACATED 11TH STREET (A.K.A. CRESCENT STREET); THENCE NORTH 54°01'00" EAST ALONG SAID CENTERLINE OF 11TH



STREET, 89.66 FEET; THENCE LEAVING SAID CENTERLINE NORTH 35°59'00" WEST ALONG THE SOUTHWESTLY BOUNDARY OF LOTS 1 THROUGH 4 OF BLOCK 47, SNYDER'S ADDITION TO PARK CITY, 115.00 FEET TO THE NORTHWEST CORNER OF SAID LOT 4, BLOCK 47, SNYDER'S ADDITION TO PARK CITY; THENCE NORTH 54°01'00" EAST ALONG THE NORTHERLY LINE OF SAID LOT 4, 100.00 FEET TO THE CENTERLINE OF VACATED PINYON AVENUE; THENCE NORTH 35°59'00" WEST ALONG SAID CENTERLINE OF PINYON AVENUE, 159.88 FEET; THENCE LEAVING SAID CENTERLINE NORTH 25°52'01" WEST A DISTANCE OF 142.33 FEET TO THE NORTHWEST CORNER OF LOT 17, BLOCK 44, SNYDER'S ADDITION TO PARK CITY, SAID POINT ALSO BEING ON THE EASTERLY RIGHT OF WAY LINE OF SAID VACATED PINYON AVENUE; THENCE NORTH 35°59'00" WEST ALONG SAID EASTERLY RIGHT OF WAY LINE OF PINYON AVENUE, 171.59 FEET TO THE WEST LINE OF SAID SNYDER'S ADDITION TO PARK CITY, SAID WESTERLY LINE OF SNYDER'S ADDITION TO PARK CITY IS ALSO THE NORTH-SOUTH 1/16 SECTION LINE (WEST LINE OF THE SOUTHEAST QUARTER OF THE NORTHWEST QUARTER) OF SAID SECTION 16; THENCE NORTH 00°31'00" EAST ALONG SAID WESTERLY LINE OF SNYDER'S ADDITION TO PARK CITY, AND ALONG SAID NORTH-SOUTH 1/16 SECTION LINE, 526.72 FEET TO THE POINT OF BEGINNING.

CONTAINS: 653,761 SQUARE FEET (15.0083 ACRES) MORE OR LESS

TAX PARCEL NUMBER: SA-315-318-321

**EXHIBIT B**  
**MPD APPROVAL LETTER**



22 January 2018

Rory Murphy  
1887 Gold Dust Lane, Suite 301  
Park City, Utah 84060

**Re: King's Crown Master Planned Development and Conditional Use Permit**

Rory:

On January 10, 2018, the Planning Commission of Park City approved your Master Planned Development (application no. PL-17-03515) and Conditional Use Permit (PL-17-03566), subject to the following findings of fact, conclusions of law, and conditions of approval:

**Master Planned Development & Conditional Use Permit Findings of Fact:**

1. The subject site is located at 1201 – 1299 Lowell Avenue.
2. The subject site is within the RC, ROS, and SLO District.
3. The proposed development takes place roughly over 30% of the property, all contained within the RC District located adjacent to Lowell Avenue towards the northeast of the subject site.
4. The applicant proposes to build three (3) multi-unit buildings with access off Lowell Avenue, a private road/drive to be known as Rothwell Road, and a townhouse building with access off Rothwell Road.
5. The proposed private road/drive begins at the 12<sup>th</sup> Street / Lowell Avenue intersection which then curves up to a hammer-head turn around.
6. Rothwell Road climbs up approximately sixty feet (60') and is approximately 548 feet long.
7. The applicant also proposes to develop 27 single-family lots, 4 of which would be accessed off Lowell Avenue, and the remaining 24 would be accessed off Rothwell Road (15 on the west side of the private road and 8 on the east side of the private road).
8. The applicant does not plan on building the 27 houses, but to develop the lots to be able to sell them individually.
9. The MPD includes a total of 32 lots.
10. The MPD includes seven (7) deed restricted affordable housing condominium

Park City Municipal Corporation • 445 Marsac Avenue • P.O. Box 1480 • Park City, Utah 84060-1480  
Building (435) 615-5100 • Engineering (435) 615-5055 • Planning (435) 615-5060

# Attachment 1 – Proposed Development Agreement

Rory Murphy  
22 January 2018  
Page 2 of 13

- units (8.55 affordable unit equivalents).
11. The MPD includes eight (8) additional non-required deed restricted affordable housing condominium units (9.07 affordable unit equivalents).
  12. The MPD includes 11.2 acres of platted open space in the form of large tracts of contiguous natural open space that does not include open space area around the units, equating to 74.6%. The total open space percentage is 83.9.
  13. The MPD includes 23 market rate condominiums, 7 market rate townhomes, and 27 market rate single family detached houses.
  14. Building A is a multi-unit dwelling, listed as a conditional use.
  15. Building A has 15 residential affordable housing units.
  16. Building A has the following square footage:
    - a. Residential: 16,520
    - b. Mechanical: 256
    - c. Internal circulation (hallways and stairs): 1,833
    - d. Parking and vehicular circulation: 5,571
    - e. Overall: 24,180
  17. Building A has 18 parking spaces located in an enclosed underground parking garage.
  18. Building A has vehicular access off Lowell Avenue through one (1) driveway.
  19. Building A has 5 stories above the parking garage.
  20. Building A is on proposed lot 1.
  21. Affordable housing residential units do not count towards residential Unit Equivalents.
  22. Building B/C is a multi-unit dwelling, listed as a conditional use.
  23. Building B/C has 12 residential units.
  24. Building B/C has the following square footage:
    - a. Residential: 28,253 (14.13 residential Unit Equivalents)
    - b. Mechanical: 375
    - c. Internal circulation (hallways, stairs, and elevator): 1,133
    - d. Parking and vehicular circulation: 9,305
    - e. Overall: 39,066
  25. Building B/C has 21 parking spaces located in enclosed underground parking garages.
  26. Building B/C has vehicular access off Lowell Avenue through two (2) separate driveways.
  27. Building B/C has 4 stories above the parking garage
  28. Building B/C is on proposed lot 2
  29. Building D is a multi-unit dwelling, listed as a conditional use.
  30. Building D has 11 residential units
  31. Building D has the following square footage:
    - a. Residential: 24,590 (12.30 residential Unit Equivalents)
    - b. Mechanical: 166
    - c. Internal circulation (hallways, stairs, and elevator): 1,827
    - d. Parking and vehicular circulation: 8,313
    - e. Overall: 34,896
  32. Building D has 22 parking spaces located in an enclosed underground parking

Park City Municipal Corporation • 445 Marsac Avenue • P.O. Box 1480 • Park City, Utah 84060-1480  
Building (435) 615-5100 • Engineering (435) 615-5055 • Planning (435) 615-5060

# Attachment 1 – Proposed Development Agreement

Rory Murphy  
22 January 2018  
Page 3 of 13

- garage.
33. Building D has vehicular access off Lowell Avenue through one (1) driveway.
  34. Building D has 4 stories above the parking garage.
  35. Building D is on proposed lot 2.
  36. Townhomes Building is a multi-unit dwelling, listed as a conditional use.
  37. Townhomes Building has 7 residential units
  38. Townhomes Building is 29,005 (14.50 residential Unit Equivalents).
  39. Townhomes Building has 14 parking spaces, 2 within each parking garage.
  40. Townhomes Building has vehicular access off proposed private drive through individual driveways.
  41. Townhomes Building has 3 stories above the garage level.
  42. Townhomes Building is on proposed lot 30
  43. Single-family dwellings are an allowed use within the District.
  44. The applicants request to plat 27 lots to accommodate one (1) single-family dwelling on each lot.
  45. The approximate buildable square footage of the single family dwellings is 71,880 (35.94 residential Unit Equivalents).
  46. The single-family dwellings require 54 parking spaces, 2 within each lot as required.
  47. The single-family dwellings have vehicular access off proposed private drive through individual driveways and four (4) off Lowell Avenue.
  48. The single family lots are on proposed lots 3-29.
  49. The applicant proposed two (2) lots to be re-platted as open space.
  50. Proposed open space Lot 31 is 2,106.4 square feet with retaining walls and stair access to adjacent property to the south.
  51. Proposed open space Lot 32 is 487,798.29 square feet (11.2 acres).
  52. Proposed open space Lot 32 is to house an accessory building, 750 square feet, consisting of restroom and lockers for the exclusive use of property owners.
  53. The proposed accessory building on Lot 32 is located on the RC District.
  54. Accessory buildings are an allowed use with the RC District.
  55. Restrooms/lockers are considered residential accessory space and does not count towards Unit Equivalents.
  56. The site contains a total of 653,860 sf. (15.01 acres) broken down in the following manner:
    - a. RC District: 199,867 sf. (4.59 acres)
    - b. RC District within the SLO Zone: 78,654 sf. (1.81 acres)
    - c. ROS District: 84,194 sf. (1.93 acres)
    - d. ROS District within the SLO Zone: 291,145 sf. (6.68 acres)
  57. The applicant proposes to build solely within the zoning boundaries of the RC District. The applicant does not request to build within the boundary of the RC District/SLO, or within the ROS District, and these areas would be dedicated as open space.
  58. Within the RC District, sites with multi-unit dwellings receive a maximum floor area ratio (FAR) of 1.0.
  59. The portion of the site in the RC District has a maximum floor area of 199,867 sf. for multi-unit dwellings.
  60. The RC District does not provide a FAR standard for single-family dwelling lots,

Park City Municipal Corporation • 445 Marsac Avenue • P.O. Box 1480 • Park City, Utah 84060-1480  
Building (435) 615-5100 • Engineering (435) 615-5055 • Planning (435) 615-5060



# Attachment 1 – Proposed Development Agreement

Rory Murphy  
22 January 2018  
Page 4 of 13

- but rather, a minimum lot area requirement of 1,875 sf.
61. The proposal contains a total FAR of 0.41 (80,963 ÷ 199,867) for multi-unit dwellings.
  62. In applying the FAR at its maximum, the site would have a remaining 118,904 sf. in density (199,867 - 80,963).
  63. In applying the floor area not used for multi-unit dwelling for single-family dwellings, this would create approximately 63 residential lots (applying the minimum lot area of 1,875 square feet).
  64. The applicant requests to re-subdivide 27 single-family lots in conjunction with their 80,963 sf. of multi-unit dwellings.
  65. A residential Unit Equivalent is 2,000 square feet.
  66. The applicant proposes the construction of the following 30 residential units and the allotment of 27 lots:
    - a. 12 flats within multi-unit Building B/C totaling 27,683 square feet (13.84 residential Unit Equivalents).
    - b. 11 flats within multi-unit Building D totaling 24,255 square feet (12.13 residential Unit Equivalents).
    - c. 7 townhouses within the Townhome Building totaling 29,005 square feet (14.50 residential Unit Equivalents).
    - d. 27 lots to accommodate one (1) future single-family dwelling on each lot which would be approximately 71,880 square feet (35.94 residential Unit Equivalents).
  67. The applicant requests to maintain the MPD setback of 25 feet around the perimeter of the entire development, with the exception of seven (7) future single-family residential Lots 3-7 and 21-22.
  68. Applicant seeks the following setback reductions as allowed by the Code, if granted by the Planning Commission:
    - a. Proposed Lot 3-7 front setback reduction to ten feet (10').
    - b. Proposed Lot 21 side setback reduction to twenty feet (20').
    - c. Proposed Lot 22 side setback reduction to ten feet (10').
  69. The proposed setback reductions as described above matches the abutting zone setbacks and all aspect of the project will comply with applicable Building and Fire codes. The reductions do not increase project density, maintain the general character of the surrounding neighborhood in terms of mass, scale and spacing between houses, and they meet open space requirements of the MPD.
  70. The proposed setback reductions are in compliance with LMC MPD provisions.
  71. All Master Planned Developments shall contain a minimum of sixty percent (60%) open space as defined in LMC Chapter 15-15 [...].
  72. The site contains a total of 653,759 square feet. The site contains 17,012 square feet of hard-scaped plazas equating to 2.6% of the site and 531,519 square feet (12.20 acres) equating to 81.3% of natural open space.
  73. The applicant proposes to designate the use of the two (2) open space lots on the proposed Re-Subdivision (plat).
  74. The applicant does not request to decrease the required number of off-street parking spaces; therefore, no parking analysis has been submitted. See building by building requirement:

Park City Municipal Corporation • 445 Marsac Avenue • P.O. Box 1480 • Park City, Utah 84060-1480  
Building (435) 615-5100 • Engineering (435) 615-5055 • Planning (435) 615-5060

# Attachment 1 – Proposed Development Agreement

Rory Murphy  
22 January 2018  
Page 5 of 13

- a. Affordable Housing Building A requires 18 parking spaces based on the size of the units. The proposed building contains 18 parking spaces.
  - b. Building B/C requires 21 parking spaces based on the size of the units. The proposed building contains 21 parking spaces.
  - c. Building D requires 21 parking spaces based on the size of the units. The proposed building contains 22 parking spaces.
  - d. Townhome building requires 14 parking spaces based on the size of the units, two (2) parking spaces per unit. Proposed building contains 14 parking spaces.
  - e. Single-family dwelling residential lots require 54 parking spaces, based on unit count. These 27 residential lots would require a minimum of 2 parking spaces per unit.
75. The proposal complies with the provisions of the building height parameters for multi-unit buildings listed under LMC § 15-2.16-4 Building Height and single-family dwellings listed under LMC § 15-2.16-5 Special Requirements For Single Family And Duplex Dwellings (subsection L-M), including all applicable height exceptions as allowed in the LMC.
  76. The applicant does not seek additional height under the MPD parameters listed under LMC § 15-6-5 MPD Requirements, Sub-section F.
  77. The project has been designed to maintain the existing neighborhood development pattern, with the larger scale buildings located alongside the existing multi-family.
  78. The proposed plan uses the massing of the buildings to mitigate the need for retaining walls by burying the buildings into the hillside. The balance of the required retaining walls has been stepped in shorter wall sections to reduce/eliminate tall retaining walls.
  79. Roads and utility lines are proposed to work with the existing grades to the greatest extent possible, as indicated on the civil site and grading plans. Areas of the deepest cuts are mitigated by using the townhome buildings to step up the hill.
  80. All trails proposed with the MPD are incorporated into open space elements and in some areas are maintained and improved in their existing locations. Trail easements will be platted on the final recorded subdivision plats. Staff recommends adding a public recreation easement on Rothwell Road (private road) connecting to trail network on the mountain.
  81. The City requests to secure a recreational public access easement from Lowell Avenue, up the roadway to the stairwell shown on the plans, to allow for public trail access.
  82. The City requests to prepare a public trail plan for the open space parcel, provide for trail 'corridors' subject to final alignment, which would be part of the recorded development agreement. The applicant stipulates to this condition of approval.
  83. There are sufficient areas adjacent to the streets, driveways, and parking areas to store snow.
  84. The MPD shall comply with the trash storage and collection and recycling regulations contained herein.
  85. There are no commercial or non-residential uses with this project, and all off-

Park City Municipal Corporation • 445 Marsac Avenue • P.O. Box 1480 • Park City, Utah 84060-1480  
Building (435) 615-5100 • Engineering (435) 615-5055 • Planning (435) 615-5060

# Attachment 1 – Proposed Development Agreement

Rory Murphy  
22 January 2018  
Page 6 of 13

- street parking requirements are met within the project. The bus stop/ transportation area is located yards away from the project at the resort base. The applicant is considering placing an e-bike sharing station on site on Lowell Avenue for public use.
86. The submitted landscape plans specify the maximum area allowed for lawn or turf is limited to fifty percent (50%) of the total Area allowed to be disturbed and not covered by Buildings and other hard surfaces.
  87. Drought tolerant species and species native to the area are stipulated in the Guidelines. Native rock and boulders are stipulated as allowed within the LMC.
  88. Lighting is proposed to comply with requirements of LMC Chapter 15-5, Architectural Review and is further spelled out in the Guidelines.
  89. No development within the MPD is located within the SLO with the exception of trails, which are an allowed use in the SLO.
  90. The proposal includes 200% of the required Affordable Housing as required by the current housing resolution (03-2017).
  91. The current affordable housing proposal, which is developed through the Affordable Housing Staff and the Affordable Housing Authority (The City Council), is shown on a table within this staff report. The Staff and the Affordable Housing Authority retain the final say on these figures.
  92. The proposal does not create additional demands for child care.
  93. An environmental survey (Exhibit P - Environmental Survey) was prepared revealing no environmental contaminants on the property.
  94. A mine site study (Exhibit Q - Mine Site Studies) was conducted and determined that there were no mining related activities on the property.
  95. The proposal fulfills the following goals and objectives of the General Plan.
  96. A cultural survey (Exhibit O - Cultural Survey) was prepared revealing the only significant historical element on site was the Crescent Tramway, which will remain as the existing ski/ bike trail on the property. There are no historic structures on site.
  97. LMC § 15-6-4 (G) states that once the Planning Commission has approved an MPD, the approval shall be put in the form of a Development Agreement and shall be submitted to the Planning Department within six (6) months of MPD approval, for ratification by the Planning Commission..
  98. Multi-unit dwellings and Master Planned Developments are listed as a conditional uses in the RC District.
  99. The applicant proposes the construction of four (4) multi-unit dwelling buildings which includes one (1) building housing the affordable housing units that exceeds the required affordable housing requirements.
  100. There are certain uses that, because of unique characteristics or potential impacts on the municipality, surrounding neighbors, or adjacent land uses, may not be compatible in some areas or may be compatible only if certain conditions are required that mitigate or eliminate the detrimental impacts.
  101. A conditional use shall be approved if reasonable conditions are proposed, or can be imposed, to mitigate the reasonably anticipated detrimental effects of the proposed Use in accordance with applicable standards.
  102. The project is located on Lowell Avenue, between 12th and 13<sup>th</sup> Street.

Park City Municipal Corporation • 445 Marsac Avenue • P.O. Box 1480 • Park City, Utah 84060-1480  
Building (435) 615-5100 • Engineering (435) 615-5055 • Planning (435) 615-5060

# Attachment 1 – Proposed Development Agreement

Rory Murphy  
22 January 2018  
Page 7 of 13

103. The four (4) multi-unit dwellings are located at the lower portion of the subject site.
104. A traffic study (Triton Engineering, June, 2017) was provided by the applicant and reviewed by the City indicating that study intersections are anticipated to continue operating at acceptable levels of service.
105. Capacity of existing streets can handle anticipated normal traffic especially based on the fact that maximum density is not being pursued by the applicant.
106. Utilities necessary for these proposed uses are available at or near the site.
107. Final utility plans, including grading and storm water run-off plans will be required at time of building permit review.
108. The proposed plans have been reviewed by the City and the Park City Fire District for compliance and meet the requirements for emergency vehicle access based on the close proximity to Lowell Avenue and the direct connection of the private drive.
109. The proposed conditional use meets all LMC parking regulations.
110. The internal circulation plan incorporated on the site plan showing proposed access to existing trails as well community access point to the trails and ski runs.
111. Adjoining uses mirror the uses proposed in this project, and no separation is required. In fact, the project is providing community access through to adjacent open space.
112. The project has been designed to mirror the existing neighborhood development patterns.
113. The larger mass buildings are located adjacent to the larger buildings on Lowell, and the project homes mirror the East side of Lowell, with the townhomes continuing the townhome pattern as well.
114. As designed, approximately 82 percent of the project is contiguous open space, with access to skiing and bike trails.
115. All signs and lighting for the project will be approved through the Master Sign Plan application process and through building department review for compliance with the LMC.
116. The physical design of the proposed additions and new buildings, in terms of mass, scale, style, design and architectural detailing.
117. The proposed buildings complement the existing neighborhood in architectural character, materials, colors, mass and scale.
118. Proposed materials consist of metal and membrane roofing, wood and metal siding, natural stone and other elements consistent with the existing buildings.
119. This project will not create any of the conditions listed that are not normally associated in the residential nature of the proposed use.
120. There will be no commercial delivery or service vehicles to the project as the entire project is residential. Typical residential delivery service will utilize residential streets and driveways.
121. Trash and Recycling will mirror the existing Old Town pattern and usage with small residential trash bins, and shall comply with the required regulation listed under Master Planned Developments.
122. All condominiums will be sold as wholly owned condominiums and be required to follow local guidelines relative to other uses, the same applies to the single-family

Park City Municipal Corporation • 445 Marsac Avenue • P.O. Box 1480 • Park City, Utah 84060-1480  
Building (435) 615-5100 • Engineering (435) 615-5055 • Planning (435) 615-5060

# Attachment 1 – Proposed Development Agreement

Rory Murphy  
22 January 2018  
Page 8 of 13

- lots.
123. The proposed development is not within any environmentally sensitive lands, physical mine hazards, historic mine waste, or Park City Soils Ordinance.
  124. The site is within steep slopes found throughout the site.
  125. The overall proposal, both Multi-Unit Dwellings (conditional use) and single-family detached houses (allowed use) takes place over approximately 30% of the entire site.
  126. The Applicant provided Exhibit R - Proposed Export Fill Placement Exhibit and Possible Fill Locations, with the placement, volume and height of on-mountain waste rock on a map showing the placement areas for waste rock
  127. Applicant indicates a verbal agreement with Park City Mountain representatives to place the material from the multi-unit buildings and road construction on Park City Mountain.
  128. Exhibit R - Proposed Export Fill Placement Exhibit and Possible Fill Locations also shows the proposed study of the corresponding volumes and depths of the waste material on adjacent property.
  129. Applicant indicates that all waste material must be certified as environmentally clean, compacted in no more than 2-foot lifts (to achieve a 90%+ compaction) covered with six inches (6") of topsoil, seeded with a native grass mix and sod placed over the grass seeds.
  130. Applicant demonstrates that the maximum depth would be 5 feet, tapering off to 0 feet.
  131. Applicant proposes to transport the excavated material to the neighboring property without the necessity of using City streets. It is the Applicant's responsibility to seek such permission with the neighboring site.
  132. Applicant explains that in the highly unlikely case that they are unable to secure a written agreement with the Park City Mountain, the excavation material would be disposed of by the traditional method used in the vast majority of construction projects to be approved by the City prior to issuance of building permits.
  133. The applicant estimates 14,400 cubic yards of material (includes swell) which would equate to 1,440 truckloads (at 10 yds. / truck).
  134. As a Condition of Approval, the applicant has indicated that they would not undergo excavation or footings and foundation work on the multi-family buildings or the access road during the winter season from Christmas through April 1st.
  135. Applicant has indicated that they will instruct construction staff to keep delivery trucks off the streets during the peak busy times of between 8:30 am and 10:00 am as well as the peak afternoon times of 3:30 pm through 4:30 pm.
  136. Applicant agrees to not deliver materials during the busiest tourist times of Christmas week, MLK weekend, Sundance week, MLK weekend, President's Day weekend, Arts Fest, July 4<sup>th</sup> weekend, Miner's Day weekend, and Tour de Utah.
  137. Applicant has provided the approximate excavation quantities of the 27 single-family dwellings which would be approximately 7500 cubic yards.
  138. The applicant does not plan on building the 27 single-family dwellings but plans to sell the lots to individuals and/or builders.
  139. The Chief Building official has studied the applicant's preliminary Construction

Park City Municipal Corporation • 445 Marsac Avenue • P.O. Box 1480 • Park City, Utah 84060-1480  
Building (435) 615-5100 • Engineering (435) 615-5055 • Planning (435) 615-5060



# Attachment 1 – Proposed Development Agreement

Rory Murphy  
22 January 2018  
Page 9 of 13

Mitigation Plan and finds that the proposal is in compliance with current Building Department policies.

140. Construction Mitigation Plan will be finalized by the Building Dept. once building permits are submitted by the applicant.
141. The applicant stipulates to the conditions of approval.
142. The discussion in the Analysis section is incorporated herein.

## Master Planned Development Conclusions of Law

- A. The MPD, as conditioned, complies with all the requirements of the Land Management Code;
- B. The MPD, as conditioned, meets the minimum requirements of Section 15-6-5 herein;
- C. The MPD, as conditioned, provides the highest value of Open Space, as determined by the Planning Commission;
- D. The MPD, as conditioned, strengthens and enhances the resort character of Park City;
- E. The MPD, as conditioned, compliments the natural features on the Site and preserves significant features or vegetation to the extent possible;
- F. The MPD, as conditioned, is Compatible in Use, scale, and mass with adjacent Properties, and promotes neighborhood Compatibility, and Historic Compatibility, where appropriate, and protects residential neighborhoods and Uses;
- G. The MPD, as conditioned, provides amenities to the community so that there is no net loss of community amenities;
- H. The MPD, as conditioned, is consistent with the employee Affordable Housing requirements as adopted by the City Council at the time the Application was filed.
- I. The MPD, as conditioned, meets the Sensitive Lands requirements of the Land Management Code. The project has been designed to place Development on the most developable land and least visually obtrusive portions of the Site;
- J. The MPD, as conditioned, promotes the Use of non-vehicular forms of transportation through design and by providing trail connections; and
- K. The MPD has been noticed and public hearing held in accordance with this Code.
- L. The MPD, as conditioned, incorporates best planning practices for sustainable development, including water conservation measures and energy efficient design and construction, per the Residential and Commercial Energy and Green Building program and codes adopted by the Park City Building Department in effect at the time of the Application.
- M. The MPD, as conditioned, addresses and mitigates Physical Mine Hazards according to accepted City regulations and policies.
- N. The MPD, as conditioned, addresses and mitigates Historic Mine Waste and complies with the requirements of the Park City Soils Boundary Ordinance.
- O. The MPD, as conditioned, addresses Historic Structures and Sites on the Property, according to accepted City regulations and policies, and any applicable Historic Preservation Plan.

Park City Municipal Corporation • 445 Marsac Avenue • P.O. Box 1480 • Park City, Utah 84060-1480  
Building (435) 615-5100 • Engineering (435) 615-5055 • Planning (435) 615-5060

# Attachment 1 – Proposed Development Agreement

Rory Murphy  
22 January 2018  
Page 10 of 13

## Conditional Use Permit Conclusions of Law:

1. The proposal satisfies the Conditional Use Permit review criteria as established by the LMC's Conditional Use Review process (§15-1-10(E), Criteria 1-16).
2. The proposal complies with all requirements of this LMC.
3. The Uses will be Compatible with surrounding Structures in Use, scale, mass
4. The effects of any differences in Use or scale have been mitigated through careful planning.

## Master Planned Development & Conditional Use Permit Conditions of Approval:

1. All standard project conditions shall apply.
2. A Construction Mitigation Plan (CMP) shall be submitted and approved by the City for compliance with the Municipal Code, as a condition precedent to issuance of any grading or building permits. The CMP shall be updated as necessary to identify impacts and propose reasonable mitigation of these impacts on the site, neighborhood, and community due to construction of this project. The CMP shall include information about specific construction phasing, traffic, parking, service and delivery, stock-piling of materials and staging of work, work hours, noise control, temporary lighting, trash management and recycling, mud and dust control, construction signs, temporary road and/or trail closures, limits of disturbance fencing, protection of existing vegetation, erosion control, Storm-water management, and other items as may be required by the Building Department. The immediate neighborhood and community at large shall be provided notice at least 24 hours in advance of construction work impacting private driveways, street closures, and interruption of utility service.
3. A storm water run-off and drainage plan shall be submitted with the building plans and approved prior to issuance of any building permits. The plan shall follow Park City's Storm Water Management Plan and the project shall implement storm water Best Management Practices. Post development drainage shall not exceed predevelopment drainage conditions and special consideration shall be made to protect any wetlands delineated on and adjacent to the site.
4. The project is over 1.0 acres and will be required to meet the requirements of Park City's municipal separate storm sewer system (MS4) storm-water program.
5. Final utility plans, consistent with preliminary utility plans reviewed by the Planning Commission during the MPD review, shall be submitted with the final subdivision plat.
6. Dry utility infrastructure must be located on the property and shown on the building plans prior to building permit issuance to ensure that utility companies verify that the area provided for their facilities are viable and that exposed meters and boxes can be screened with landscaping.
7. The Snyderville Basin Water Reclamation District's review and approval of the utility plans and final subdivision plat, for conformance with the District's standards for review, is a condition precedent to plat recordation and building permit issuance.
8. An Affordable Housing Plan shall be approved by the Park City Housing Authority prior to issuance of any building permits for units within the MPD and deed restrictions shall be recorded.

Park City Municipal Corporation • 445 Marsac Avenue • P.O. Box 1480 • Park City, Utah 84060-1480  
Building (435) 615-5100 • Engineering (435) 615-5055 • Planning (435) 615-5060

# Attachment 1 – Proposed Development Agreement

Rory Murphy  
22 January 2018  
Page 11 of 13

9. As a condition precedent to receiving a certificate of occupancy for any market rate unit the City shall be provided with proof of compliance with the approved Affordable Housing Plan.
10. A master sign plan for the project shall be submitted, reviewed for compliance with the Park City Sign Code, and approved by the City, as a condition precedent to issuance of any individual sign permits.
11. Approval of this Master Planned Development is subject to LMC Chapter 6- Master Planned Developments and shall expire two years from the date of execution of the Development Agreement unless Construction, as defined by the Uniform Building Code, has commenced on the project.
12. Once the Planning Commission has approved an MPD, the approval shall be put in the form of a Development Agreement. The Development Agreement must be submitted to the Planning Department for ratification by the Planning Commission within 6 months of this approval. The Development Agreement shall be signed by the Mayor on behalf of the City Council and recorded with the Summit County Recorder.
13. Timing of completion of all required items and public benefits shall be further described and stated in the Development Agreement.
14. Vegetation and landscaping will be planted in such a manner that screening of adjacent properties is to be consistent with approved landscape plans. The applicant recognizes that the City Engineer have final authority on landscape placement in required easement areas.
15. All interior roads shall be constructed to Park City Engineering standards. Final grades, storm drainage and width to be approved by the City Engineer.
16. Interior roads are proposed to be private and maintained by the HOA.
17. An HOA shall be in place to maintain and govern the property.
18. An open space use plan shall be approved by the Park City Planning Department and shall be included as part of the development agreement. Such uses shall be consistent with the LMC and shall include ski runs, hiking/biking trails and related ski improvements such as snow making and signage as needed and appropriate.
19. A trails master plan that is consistent with the city's needs and desires shall be forwarded by the City Trails personnel and approved by both the applicant and the Park City Planning Department, which would be part of the recorded development agreement.
20. The applicant shall allow a recreational public access easement from Lowell Avenue, up the roadway to the stairwell shown on the plans, to allow for public trail access, and shall be shown on the plat.
21. The proposal shall comply with all Architectural Design Guidelines outlined in LMC § 15-5-5 which includes prohibited architectural styles and motifs, prohibited siding materials, design ornamentation, number of exterior wall materials, roofing materials, roof shapes, solar panels and skylights, window treatments, Lighting, trash and recycling enclosures, mechanical equipment, patios and driveways, and landscaping. Materials color samples and final design details shall be approved by staff prior to building permit issuance and shall be in substantial compliance with the elevations reviewed by the Planning Commission on January 10, 2018.

Park City Municipal Corporation • 445 Marsac Avenue • P.O. Box 1480 • Park City, Utah 84060-1480  
Building (435) 615-5100 • Engineering (435) 615-5055 • Planning (435) 615-5060

# Attachment 1 – Proposed Development Agreement

Rory Murphy  
22 January 2018  
Page 12 of 13

22. The proposal shall comply with the trash storage and collection parameters with the language outlined in LMC § 15-5-5(G).
23. The proposal shall not undergo excavation or footings and foundation work on the multi-family buildings or the access road (Rothwell Road) during the winter season from Christmas (December 25) through April 1st.
24. Materials shall not be delivered during the busiest tourist times of Christmas week, MLK weekend, Sundance week, MLK weekend, President's Day weekend, Arts Fest, July 4<sup>th</sup> weekend, Miner's Day weekend, and Tour de Utah.
25. The final building plans and construction details for the project shall substantially comply with the drawings reviewed by the Planning Commission on January 10, 2018.
26. The applicant shall record a plat prior to selling individual units.
27. A deed restriction all affordable housing units shall be recorded prior building permit issuance.
28. The CCRs shall be submitted with the plat for review and approval by the City prior to final plat recordation.
29. The CCRs submitted with condominium plats that include any deed restricted affordable housing units shall limit the HOA dues related to the deed restricted employee housing unit in order to ensure that the units remain affordable. The CCRs shall reflect a lower par-value to reflect the reduced cost of the units (or exempt the units from HOA fees) to ensure that the units don't lose their affordability due to HOA fees. The CCRs shall be submitted with the condominium plat for review and approval by the City prior to final condominium plat recordation.
30. The Conditional Use Permit shall expire on January 10, 2019, unless an extension is requested in writing prior to expiration date and the extension is granted by the Planning Director.
31. A final water efficient landscape and irrigation plan that indicates required storm water facilities and snow storage areas, and that meets the defensible space requirements and mitigates for removal of significant vegetation, shall be submitted with the building permit application for approval by the Planning, Building, and Engineering Department, and shall be in substantial conformance with the plans reviewed by the Planning Commission on January 10, 2018.
32. All requirements and conditions of the Snyderville Basin Water Reclamation District shall be met prior to building permit issuance.
33. This development is part of a common development that is greater than one (1) acre. This development shall meet the MS4 storm water requirements.

Please be aware that this approval in no way exempts the property from complying with other requirements that may be in effect on the property, and building permit regulations, as applicable. It is the responsibility of the property owner to ensure compliance with these regulations.

As the applicant, this letter is intended as a courtesy to document the status of your request. The official minutes from the Planning Commission meeting are available in the Planning Department office.

Park City Municipal Corporation • 445 Marsac Avenue • P.O. Box 1480 • Park City, Utah 84060-1480  
Building (435) 615-5100 • Engineering (435) 615-5055 • Planning (435) 615-5060

# Attachment 1 – Proposed Development Agreement

Rory Murphy  
22 January 2018  
Page 13 of 13

If you have questions regarding your applications or the action taken please don't hesitate to contact me at 435-615-5064 or [fastorga@parkcity.org](mailto:fastorga@parkcity.org).

Sincerely,



Francisco Astorga, AICP  
Senior Planner

Park City Municipal Corporation • 445 Marsac Avenue • P.O. Box 1480 • Park City, Utah 84060-1480  
Building (435) 615-5100 • Engineering (435) 615-5055 • Planning (435) 615-5060



**EXHIBIT C**  
**CULTURAL SURVEY**

**EXHIBIT D**  
**MINE SITE STUDIES**

**EXHIBIT E**

**PROPOSED EXPORT FILL**

**Placement Exhibit and Possible  
Fill Locations**

**EXHIBIT F**

**SFD APPROXIMATE EXCAVATION QUANTITIES**

**EXHIBIT G**  
**GENERAL DRAWINGS**



**EXHIBIT H**  
**CIVIL DRAWINGS (ALTA & SLOPE)**

**EXHIBIT I**  
**PROPOSED PLAT (UPDATED)**

**EXHIBIT J**  
**SURVEY**

**EXHIBIT K**  
**CIVIL DRAWINGS**

**EXHIBIT L**  
**LANDSCAPE DRAWINGS**



**EXHIBIT M**  
**ARCHITECTURAL SITE DRAWINGS**

**EXHIBIT N**  
**SITE COMPLIANCE DRAWINGS**

**EXHIBIT O**  
**ARCHITECTURAL GRAPHICS DRAWINGS**

**EXHIBIT P**  
**ARCHITECTURAL DRAWINGS**

**EXHIBIT Q**  
**MATERIAL BOARD**



**EXHIBIT R**  
**TOWNHOME RENDERING**

**EXHIBIT S**  
**ENVIRONMENTAL SURVEY**

**EXHIBIT T**  
**OPEN SPACE USE PLAN**

# Attachment 1 – Proposed Development Agreement

March 5, 2018

Francisco Astorga, Senior Planner  
Park City Planning Department  
Park City Municipal Corporation  
PO Box 1450  
445 Marsac Avenue  
Park City, UT 84060

**RE: Open Space Plan**

Dear Francisco,

This report contains the Open Space Plan proposal for the Kings Crown at Park City Project. An Open Space Plan is one of the requirements of the Development Agreement in the Land Management Code Section 15-6-4 (G). The Conditions of Approval of the MPD for Kings Crown, which was approved by the Park City Planning Commission on January 8<sup>th</sup>, 2018 and ratified by the Park City Council on February 1<sup>st</sup>, 2018 required that an Open Space Plan be presented to and approved by the Planning Staff. The following is the applicant's Open Space plan proposal which is submitted to fulfill that requirement.

The Kings Crown MPD proposal has a total open space percentage of 83.9% of the total property. The MPD submittal requirement is 60% or greater. The Kings Crown proposal is well in excess of the MPD requirement. The total open space acreage is 12.59 acres. About 11 acres, or 74.6% of the total acreage, is contiguous, unbroken open space. This is identified as Lot 32 of the Kings Crown Re-Subdivision Plat (shown on attached Exhibit A). The contiguous open space is in the most visually prominent portion of the Kings Crown property and protects a mature, second-generation maple forest that is of particular importance for trails, wildlife, watershed protection and visual aesthetics. The ownership of the protected open space will be held for the time being by the Kings Crown HOA. Of the remaining open space, 6.7% (about 1.0 acres) of the entire acreage is open space found within and around the built-up areas of the property and 2.6% (about 0.4 acres) of the total acreage is hardscape. Included in this calculation is Lot 31 of the Kings Crown Re-Subdivision (shown on attached Exhibit B).

The Kings Crown HOA will hold title to both the contiguous open space parcel as well as the open space found within and around the project. The open space found within and around the project consists of natural areas, hardscape and landscaped areas found around the built-up portions of the project. Maintenance of the open space found within and around the project will be the responsibility of the HOA. There is also open space associated with the single-family lots that are part of the Kings Crown project. The maintenance and ownership of the open space located around the lots will be the responsibility of the individual homeowner.

The large, contiguous open space area will be maintained by both PCMC and the Kings Crown HOA. The applicant is currently working on a trails plan with the Trails Staff at PCMC and agreement has been reached regarding the location and number of trails located on the property. One of the tenants of the Trails Plan is that PCMR will have the responsibility for maintaining and controlling the area associated with the trails and the Kings Crown HOA will have the responsibility for maintaining and controlling the remaining open space area. Maintenance of this area will focus on trash removal, erosion control and protection of the natural resources associated with the open space.

The following Table 1.0 outlines the Prohibited and Restricted Uses for the contiguous open space parcel.

**Table 1.0 Prohibited and Restricted Uses for the contiguous open space parcel at Kings Crown.**

- Any industrial, commercial or for-profit recreational activity (downhill skiing is expressly permitted).
- No construction of any structures or impervious paving. (except for a ski room Residential Accessory building of about 750 square feet within the RC District and stairs/retaining walls associated with the ski access).
- No recreational improvements, except hiking/biking trails and alpine ski trails and associated equipment are permitted.
- Subdivision.
- Mining.
- Alteration of topography.
- Dumping.
- Manipulation of water.
- Roads and impervious surfaces.
- Vehicles (expressly permitted are vehicles associated with ski maintenance on the ski runs only).
- Plant removal or introduction.
- Density (units).
- Hunting.
- Perimeter fencing.
- Haying and grazing.

The following Table 2.0 outlines the Allowed and Reserved Uses for the contiguous open space parcel at Kings Crown.

**Table 2.0 Allowed and Reserved Uses for the contiguous open space parcel at Kings Crown.**

- Alpine and Nordic skiing.
- Ski-related equipment on the ski runs.
- Ski maintenance vehicles.
- Public safety vehicles.
- Conveyance of the property is allowed.
- Buried utilities associated with the ski runs.
- Signs as necessary.



## Attachment 1 – Proposed Development Agreement

- Public Access.
- Hiking/biking trails.
- Preservation, restoration or enhancement of conservation values.
- Native species may be restored.

The above conditions were agreed to be included by the applicant during the MPD approval process. They were presented both to the Planning Commission and the City Council and were approved accordingly.

Thank you for the opportunity to present this Open Space Plan to the Planning Department for review. We appreciate your consideration of this proposal and are open to any feedback or input you may have. Please do not hesitate to contact us with any questions or comments regarding this report.

Sincerely,



CRH Partners, LLC  
Rory Murphy  
Hans Fuegi  
Chuck Heath

EXHIBIT A.

**KING'S CROWN REPLAT SUBDIVISION**  
(A 32 LOT RESIDENTIAL SUBDIVISION)

LOCATED IN SECTION 18  
TOWNSHIP 2 SOUTH, RANGE 4 EAST, SALT LAKE BASIN AND MERIDIAN  
PARK CITY, SUMMIT COUNTY, UTAH

**LOT 32** ↗

**BOUNDARY DESCRIPTION**

**SEWERAGE & PRESTRESS ACCESS SEWERAGE FOR NATURAL LLC & PUBLIC**

**CONVEYANCE AND COMMENT TO RECORD**

**ACKNOWLEDGMENT**

**SURVEYOR'S CERTIFICATE**

**NARRATIVE**

**EVERGREEN ENGINEERING, INC.**

<b>CITY ENGINEER</b>	<b>SNYDERVILLE BASIN WATER RECLAMATION DISTRICT</b>	<b>CITY PLANNING COMMISSION</b>	<b>APPROVAL AS TO FORM</b>	<b>COUNCIL APPROVAL &amp; ACCEPTANCE</b>	<b>CERTIFICATE OF ATTEST</b>	<b>RECORDED</b>
DATE OF APPROVAL: _____	DATE OF APPROVAL: _____	DATE OF APPROVAL: _____	DATE OF APPROVAL: _____	DATE OF APPROVAL: _____	DATE OF APPROVAL: _____	DATE OF APPROVAL: _____

EXHIBIT B.

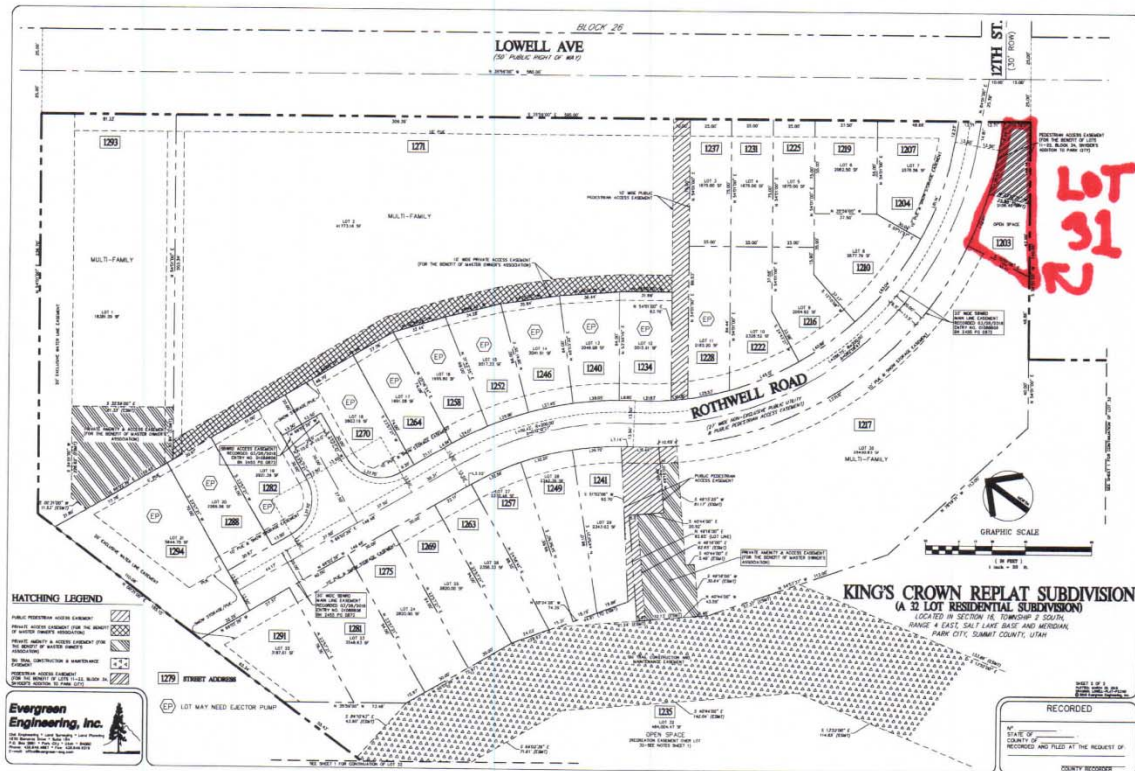

**EXHIBIT U**  
**TRAILS MASTER PLAN**

## Attachment 1 – Proposed Development Agreement

March 7, 2018

Francisco Astorga, Senior Planner  
Park City Planning Department  
Park City Municipal Corporation  
PO Box 1450  
445 Marsac Avenue  
Park City, UT 84060

### **RE: Trails Plan for Kings Crown**

Dear Francisco,

Please find attached to this report a proposed Trails Master Plan for the Kings Crown project. This Trails Master Plan has been approved by both the applicant and the City Trails Staff. We have been working with Heinrich Deters and Logan Jones to finalize this report and the attached is the result of our efforts. The applicant agrees to comply with the final trails report and will assist Park City in any way towards accomplishing the trail development outlined in the map.

The applicant further agrees to memorialize the proposed trail alignment with easements once the trails are constructed and accepted by Park City into their trail network. We think it is prudent to memorialize the trails and provide easements once they are constructed in order to ground truth the trail itself in case there are significant deviations. In any event, the applicant agrees to support the proposed trail alignment as proposed by the City Trails Staff and will cooperate in any activity needed to bring these trails to compliance and operability.

The existing trails, other than the Crescent Tram trail, are planned to be abandoned in favor of the trails outlined in the attached plan. Again, the City Trails Staff will take responsibility for this and will work towards making the necessary adjustments on the ground and educating the public about the new trail alignment. It is expected that Park City will work closely with the Mountain Trails Foundation to accomplish this goal. The City and Mountain Trails will have the responsibility to maintain the trails relative to controlling access to motorized vehicles, trash removal and erosion control as well as any other pertinent activities that may be required to maintain the trails properly. The Kings Crown HOA will retain the ownership of the property for the time being and will be responsible for supporting Park City's and Mountain Trails efforts in this regard.

Thank you for the opportunity to present this Trails Plan to the Planning Staff. Please let us know if you require any additional documentation or supporting documents to fulfill this requirement. We appreciate your consideration of this proposal and are free to answer any questions or address any comments you may have.

Sincerely,  
CRH Partners, LLC  
Rory Murphy, Chuck Heath, Hans Fuegi



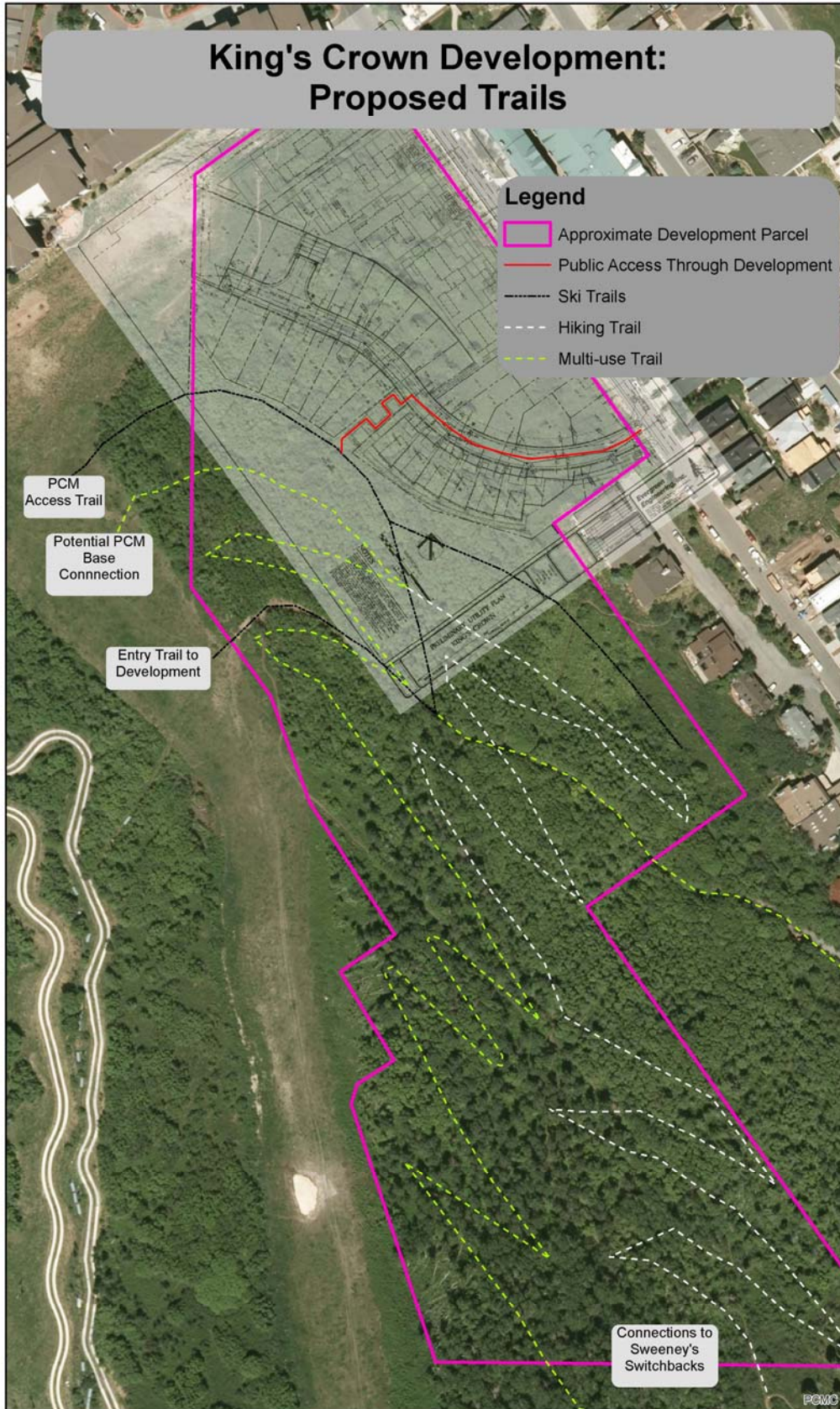

**EXHIBIT V**  
**CONSTRUCTION MITIGATION PLAN**

**Ordinance No. 2018-05**

**AN ORDINANCE APPROVING THE KINGS CROWN RE-SUBDIVISION  
LOCATED AT 1201-1299 LOWELL AVENUE, PARK CITY, UTAH.**

WHEREAS, the owners of the property located at 1201-1299 Lowell Avenue, have petitioned to the City Council for approval of the Kings Crown Re-Subdivision; and

WHEREAS, on December 23, 2017 the property was properly noticed and posted according to the requirements of the Land Management Code; and

WHEREAS, proper legal notice was published in the Park Record on December 23, 2017, and notice letters were sent to all affected property owners on December 27, 2017, in accordance with the Land Management Code; and

WHEREAS, the Planning Commission held a public hearing on January 10, 2018, to receive input on the plat;

WHEREAS, the Planning Commission, on January 10, 2018, forwarded positive a recommendation to the City Council; and,

WHEREAS, on February 1, 2018, the City Council held a public hearing on the Subdivision Plat; and

WHEREAS, it is in the best interest of Park City, Utah to approve King's Crown Re-Subdivision.

NOW, THEREFORE BE IT ORDAINED by the City Council of Park City, Utah as follows:

**SECTION 1. APPROVAL.** The above recitals are hereby incorporated as findings of fact. King's Crown Re-Subdivision Final Plat, as shown in Attachment 1 (also Exhibit U2), is approved subject to the following Findings of Facts, Conclusions of Law, and Conditions of Approval:

**Findings of Fact:**

1. The subject site is located at 1201 – 1299 Lowell Avenue.
2. The subject site is within the RC, ROS, and SLO District.
3. The site contains a total of 653,860 sf. (15.01 acres) broken down in the following manner:
  - a. RC District: 199,867 sf. (4.59 acres)
  - b. RC District within the SLO Zone: 78,654 sf. (1.81 acres)
  - c. ROS District: 84,194 sf. (1.93 acres)
  - d. ROS District within the SLO Zone: 291,145 sf. (6.68 acres)
4. The site is within the Snyder's Addition to the Park City Survey which requires the reconfiguring the entire site, 653,860 sf. (15.01 acres), into the proposed 32



- lots.
5. The applicant proposes the following lots:
    - a. Three (3) lots to accommodate the four (4) Multi-Unit Dwelling buildings: proposed lot 1, 2, and 30.
    - b. Twenty-seven (27) single-family dwelling lots: proposed lot 3 - 29.
    - c. Three (3) open space lots: proposed lot 31 - 32.
  6. The three (3) proposed multi-family lots would in the future re-platted via Condominium Plat re-subdivided into their individual units, allowing the property owner the ability to sell each unit individually.
  7. The development proposes the re-configuring of 27 single-family lots to house one single-family dwelling each.
  8. The development also proposes the re-configuring of two (2) open space lots that would be owned and maintained by the development homeowner's association.
  9. The City vacated internal Rights-of-Way (ROW) in 1966.
  10. This Re-Subdivision in conjunction with the concurrent MPD and CUP.
  11. The Re-Subdivision application request removes all platted lots within the development.
  12. Land Management Code Section 15-7.1-5 Preliminary Subdivision Plat, specifically indicates that the Planning Commission may, at its sole discretion, combine the required hearings for both preliminary and final Subdivision Plat approval.
  13. The minimum lot area for single-family dwellings in the RC District is 1,875 square feet.
  14. All of the SFD lots meet the minimum lot area requirements.
  15. The applicant has indicated that they will not seek to build (sell) duplex lots on applicable lots. A note shall be added to the plat indicating that.
  16. The applicant has filed a Line Extension Agreement with the Snyderville Basin Water Reclamation District. The City Engineer has reviewed preliminary utilities which comply as conditioned

Conclusions of Law:

1. There is Good Cause for this Final Plat as it consistent with the MPD and CUP.
2. The Final Plat is consistent with the Park City Land Management Code and applicable State law regarding subdivision plats.
3. Neither the public nor any person will be materially injured by the proposed Final Plat.
4. Approval of the Final Plat, subject to the conditions of approval stated below, will not adversely affect the health, safety and welfare of the citizens of Park City.

Conditions of Approval:

1. The City Attorney and City Engineer will review and approve the final form of plat for compliance with State law, the Land Management Code, and the conditions of approval, prior to recordation of the plat.
2. The applicant will present the final signed Mylar plat to the City, for City signatures and recordation at Summit County, within one year of the date of City Council approval, or this approval will be considered void; unless an extension

request is made in writing prior to the expiration date and an extension is granted by the City Council.

3. Approval of this Plat is subject to the Master Planned Development approval.
4. Final utility plans, consistent with preliminary utility plans reviewed by the Planning Commission during the MPD/CUP review, shall be submitted with the final subdivision plat for approval by the City Engineer.
5. Dry utility infrastructure must be located on the property and shown on the building plans prior to building permit issuance to ensure that utility companies verify that the area provided for their facilities are viable and that exposed meters and boxes can be screened with landscaping.
6. The Snyderville Basin Water Reclamation District's review and approval of the utility plans and final subdivision plat, for conformance with the District's standards for review, is a condition precedent to plat recordation and building permit issuance.
7. Utilities must be extended to the site to sustain the anticipated uses. Twenty (20') foot wide non-exclusive utility easements are generally necessary for long term maintenance and shall be dedicated on the final subdivision plats. Off-site improvements are necessary to serve the site with utilities.
8. Final road designs will be provided to the Park City Planning, Engineering and Building Departments for review and approval as part of the permit process.
9. The proposed final plat shall in compliance with criteria outlined under the LMC § 15-7.3 Requirements for Improvements, Reservations, and Design which includes the following, as applicable: general subdivision requirements, general lot design requirements, road requirements and design, drainage and storm sewers, water facilities, sewer facilities, sidewalks, hiking trails, bike paths, and horse trails, public uses, preservation of natural features and amenities. All plats are reviewed by the City Engineer for these and other applicable standards.
10. The project is over 1.0 acres and will be required to meet the requirements of Park City's municipal separate storm sewer system (MS4) storm-water program
11. Modified 13-D sprinklers will be required for new construction by the Chief Building Official at the time of review of the building permit submittal and shall be noted on the final Mylar prior to recordation
12. A note shall be added to the plat indicating that development on each SFD lot is limited to one (1) single-family dwelling.

**SECTION 2. EFFECTIVE DATE.** This Ordinance shall take effect upon publication.

PASSED AND ADOPTED this 1<sup>st</sup> day of February, 2018.

PARK CITY MUNICIPAL CORPORATION

  
Andy Beerman, MAYOR



ATTEST:

  
Michelle Kellogg, City Recorder



APPROVED AS TO FORM:

  
Mark Harrington, City Attorney



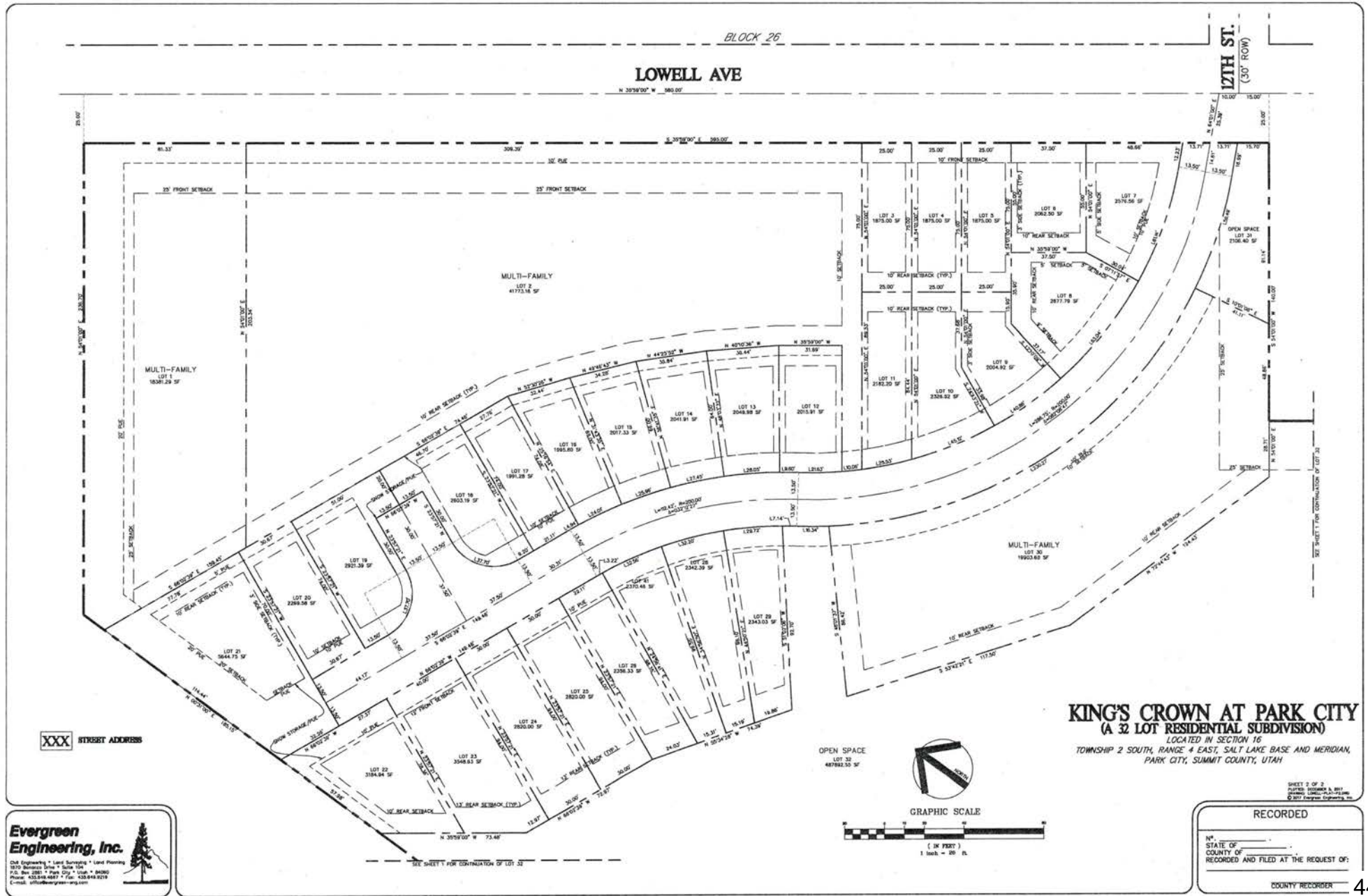



May 30, 2018

Mr. Francisco Astorga, Senior Planner  
Park City Planning Office  
Park City Municipal Corporation  
PO Box 1480  
Park City, Utah 84060

**RE: Construction Mitigation Plan**

Dear Francisco,

The following represents our proposed Construction Mitigation Plan (CMP) that is a requirement of the MPD submittal for the proposed King's Crown project per Master Planned Development/Conditional Use permit (MPD/CUP) Condition of Approval No. 2:

A Construction Mitigation Plan (CMP) shall be submitted and approved by the City for compliance with the Municipal Code, as a condition precedent to issuance of any grading or building permits. The CMP shall be updated as necessary to identify impacts and propose reasonable mitigation of these impacts on the site, neighborhood, and community due to construction of this project. The CMP shall include information about specific construction phasing, traffic, parking, service and delivery, stock-piling of materials and staging of work, work hours, noise control, temporary lighting, trash management and recycling, mud and dust control, construction signs, temporary road and/or trail closures, limits of disturbance fencing, protection of existing vegetation, erosion control. Storm-water management, and other items as may be required by the Building Department. The immediate neighborhood and community at large shall be provided notice at least 24 hours in advance of construction work impacting private driveways, street closures, and interruption of utility service.

This plan can be modified easily to comply with the direction from Staff and Commission. This represents our understanding of the requirements of the MPD, CUP and Plat Approvals for the Kings Crown project, however, we are open to any suggestions and comments you may have. The CMP is designed to minimize the effects of the construction impacts on the surrounding neighborhoods.

1. **Hours of Operation.** The applicant does not propose any construction activity beyond the existing hours of operation set by City Code. Those are 7:00 am to 9:00 pm Monday through Saturday and 9:00 am through 6:00 pm on Sunday.

See MPD/CUP Finding of Fact No. 134: As a Condition of Approval, the applicant has indicated that they would not undergo excavation or footings and foundation work on the multi-family buildings or the access road during the winter season from Christmas through April 1st.

## Attachment 3 – MPD General Construction Mitigation Plan Letter & Exhibits

See MPD/CUP Condition of Approval no. 23: The proposal shall not undergo excavation or footings and foundation work on the multi-family buildings or the access road (Rothwell Road) during the winter season from Christmas (December 25) through April 1st.

2. **Parking.** All construction and related parking will be located on the property. There will be no street parking during the construction. The single-family homes will be required to submit a parking plan to the HOA prior to receiving permission from the HOA to proceed.
3. **Deliveries.** All deliveries will be during the hours of operation only. Please see **Special Delivery Hours** section #XX below for times of further restrictions.
4. **Stockpiling and Staging.** All stockpiling and staging will be located on-site, off the public road (Lowell Avenue) and within the approved limits of disturbance.
5. **Construction Phasing.** This item will be discussed with the Planning and Building Department Staff and an approved phasing plan will be implemented prior to building permit issuance.
6. **Trash Management and Recycling.** Adequate storage and enclosed trash management will be incorporated on site during the construction process. Recycling will be undertaken both by the contractor and the applicant to ensure that the maximum amount of construction recycling can take place.
7. **Control of Dust and Mud.** This ongoing concern will be handled daily with gravel exits as well as wash down measures that ensure there is NO tracking of mud onto the neighboring streets. Dust control should not be a significant consideration due to the limited area disturbed but will be controlled through watering trucks during the construction process.
8. **Noise.** Noise levels will not exceed 65 decibels as per the noise ordinance. Noise will not be made outside of the hours of operation.
9. **Grading and Excavation.** All grading and excavation will take place within the hours of operation. The proposed truck route is to access and exit via the north end of Lowell. A turnaround will be provided on-site to accommodate this. This will keep trucks off the majority of Lowell Avenue and off Empire Avenue completely.

See MPD/CUP Finding of Fact No. 131: Applicant proposes to transport the excavated material to the neighboring property without the necessity of using City streets. It is the Applicant's responsibility to seek such permission with the neighboring site.

10. **Temporary Lighting.** As may be needed and approved beforehand by the Building Department.
11. **Construction Signage.** The required construction sign will be erected on site and will follow the temporary sign code diligently. All required information will be posted on the sign.



Permit PL-18-03807 for a temporary construction marketing sign was approved by the Planning Dept. on March 22, 2018.

**12. Dogs. Dogs will be prohibited from construction sites.**

**13. Neighborhood Notification.** Neighbors will be informed of all activities and all efforts will be made to try to minimize the disruption to the neighborhood.

See MPD/CUP COA No. 2: A Construction Mitigation Plan (CMP) shall be submitted and approved by the City for compliance with the Municipal Code, as a condition precedent to issuance of any grading or building permits. The CMP shall be updated as necessary to identify impacts and propose reasonable mitigation of these impacts on the site, neighborhood, and community due to construction of this project. The CMP shall include information about specific construction phasing, traffic, parking, service and delivery, stock-piling of materials and staging of work, work hours, noise control, temporary lighting, trash management and recycling, mud and dust control, construction signs, temporary road and/or trail closures, limits of disturbance fencing, protection of existing vegetation, erosion control. Storm-water management, and other items as may be required by the Building Department. **The immediate neighborhood and community at large shall be provided notice at least 24 hours in advance of construction work impacting private driveways, street closures, and interruption of utility service.**

**14. Soils Ordinance.** The property is located outside of the Park City Soils Ordinance.

**15. Erosion Control.** A Storm Water Pollution Protection Plan (SWPPP) will be filed with the Park City Building department as well as the Utah State Department of Environmental Quality prior to building permit issuance.

**16. SWPPP.** A SWPPP plan will be filed with the State of Utah and will be the general compliance document for the Kings Crown site relative to storm water retention and quality control. The SWPPP plan calls for frequent compliance inspections throughout the life of the project's construction. See item 15.

**17. Toilet Facilities.** All construction sites shall have permanent toilets with authorization, or temporary toilet facility. Toilets placed on the public right of way require a right of way permit from the City Engineer.

**18. Partial Road Closures.** Partial road closures are required if one lane of travel is partially blocked by construction traffic or deliveries. Partial Road Closures require 48 hours notice. Partial road closures may be obtained at the Building Department or online at [www.parkcity.org](http://www.parkcity.org).

**19. Full Road Closures.** Full road closures require approval from the City Engineer. Full Road Closures require 48 hours' notice. Full road closures applications must be filled out on line or at the Engineering Department.

20. **Right Of Way Permits.** Right of way permits are required from the City Engineers Office for any work, damage or reconstruction in the Public Right OF Way. See Municipal Code § 11-14-2 Fencing Of Public Right-Of-Way.
21. **Cranes.** All cranes must be preapproved by the Chief Building Official. Contractor will provide a site plan showing the radius of the boom over neighboring properties and streets. Airspace and trespass agreements are required to be in place in the file before the crane can be installed on the property. The crane is prohibited from swinging over neighboring properties and streets loaded or unloaded without prior approval. Flaggers are required when approval is granted if crane will affect Right of Way.
22. **Limits of Disturbance Fence.** Chain link fencing is required on sites in some areas with excavations deeper than 4 feet. Plastic construction fencing is acceptable on sites that are not being excavated. Comments: six foot chain link fence will be used on this site.
23. **Special Delivery Hours.** The applicant has agreed that it will not accept truck deliveries during the two peak times of 8:30 am to 10:00 am in the mornings and 3:30 to 4:30 pm in the afternoon hours. As a matter of the spirit of this particular restriction, it was meant for the busy ski season period times when skier traffic would be most impactful.
- See MPD/CUP Finding of Fact No. 136: Applicant agrees to not deliver materials during the busiest tourist times of Christmas week, MLK weekend, Sundance week, MLK weekend, President’s Day weekend, Arts Fest, July 4<sup>th</sup> weekend, Miner’s Day weekend, and Tour de Utah.
- See MPD/CUP Condition of Approval No. 24: Materials shall not be delivered during the busiest tourist times of Christmas week, MLK weekend, Sundance week, MLK weekend, President’s Day weekend, Arts Fest, July 4<sup>th</sup> weekend, Miner’s Day weekend, and Tour de Utah.
24. **Winter Restrictions.** The applicant has agreed that it will restrict mass excavation and footings and foundations for a) the road construction, b) the town homes, c) the affordable housing building and d) the condominium building during the very busy winter period of December 24<sup>th</sup> through April 1<sup>st</sup> of a particular calendar year in order not to have large fleets of trucks competing with skier traffic. This concession is specific to the excavation and F&F construction activities as it involves large fleets of heavy trucks and is not meant to include the delivery trucks that are a necessary part of a construction project.
- See MPD/CUP Finding of Fact No. 135: Applicant has indicated that they will instruct construction staff to keep delivery trucks off the streets during the peak busy times of between 8:30 am and 10:00 am as well as the peak afternoon times of 3:30 pm through 4:30 pm.
25. **Special Restriction Periods.** The applicant has agreed to not perform outside work except as specially permitted by the Building Department on the following holidays and busy periods:

Christmas Week, Sundance Film Festival, Presidents Weekend, The Fourth of July Weekend and Arts Fest Weekend.

See Finding of Fact No. 134: As a Condition of Approval, the applicant has indicated that they would not undergo excavation or footings and foundation work on the multi-family buildings or the access road during the winter season from Christmas through April 1st.

26. **Special Material Placement.** The applicant has agreed to place all excess material that is not re-used as site fill to be placed on the adjacent Resort property. The applicant and the City recognize that the land is owned by a third party and have agreed that in the unlikely event that such excess fill may not be placed on the resort property, the applicant will present other plans for approval. Such plans to take place prior to soil removal and pending the evaluation of the CUP/MPD approved by the Planning Commission. Also truck routes require approval by the Park City Engineering Department.

See MPD/CUP Finding of Fact No. 126: The Applicant provided [Exhibit R - Proposed Export Fill Placement Exhibit and Possible Fill Locations, with the](#) placement, volume and height of on-mountain waste rock on a map showing the placement areas for waste rock. See Applicant indicates a verbal agreement with Park City Mountain representatives to place the material from the multi-unit buildings and road construction on Park City Mountain.

See MPD/CUP Finding of Fact No. 127: Applicant indicates a verbal agreement with Park City Mountain representatives to place the material from the multi-unit buildings and road construction on Park City Mountain.

See MPD/CUP Finding of Fact No. 128: [Exhibit R - Proposed Export Fill Placement Exhibit and Possible Fill Locations](#) also shows the proposed study of the corresponding volumes and depths of the waste material on adjacent property.

See MPD/CUP Finding of Fact No. 129: Applicant indicates that all waste material must be certified as environmentally clean, compacted in no more than 2-foot lifts (to achieve a 90%+ compaction) covered with six inches (6") of topsoil, seeded with a native grass mix and sod placed over the grass seeds.

See MPD/CUP Finding of Fact No. 130: Applicant demonstrates that the maximum depth would be 5 feet, tapering off to 0 feet.

See MPD/CUP Finding of Fact No. 131: Applicant proposes to transport the excavated material to the neighboring property without the necessity of using City streets. It is the Applicant's responsibility to seek such permission with the neighboring site.

See MPD/CUP Finding of Fact No. 132: Applicant explains that in the highly unlikely case that they are unable to secure a written agreement with the Park City Mountain, the excavation material would be disposed of by the traditional method used in the vast majority of construction projects to be approved by the City prior to issuance of building permits.

See MPD/CUP Finding of Fact No. 133: The applicant estimates 14,400 cubic yards of material

(includes swell) which would equate to 1,440 truckloads (at 10 yds. / truck).

27. **Verbal Agreement from Mountain Resort.** The applicant has communicated with the resort staff and has received verbal agreements to place the material on site. Commentary: Discussion with City Officials and applicant required at this time, written permission required, Park City Mountain Limit of Disturbance (LOD) plan required, at this time.
28. **Organic Material.** The organic material generated (The “Clear and Grub”) cannot be taken to the resort property as it will decompose and settle for many years and will create an unstable surface condition for decades. As a result, the resort has indicated that it will not accept organic material. The Findings of Fact (#132) specifically references excavated material.
29. **Large Rocky Excavated Material.** The applicant would like to reserve the option to request from the Planning Staff the ability to export in the traditional method material that is composed of large rocks (approximately 12”-18+” in diameter). The resort personnel have requested that such material NOT be placed on ski runs as it will create too uneven a surface to grade and compact in the future. The applicant is aware that this is a new request and one that bears further discussion with Staff. In order to accommodate the size of material the resort personnel insist upon, a rock-crushing operation would be required. The applicant feels that a rock-crushing operation would be more impactful by far than the truck trips required to remove the material. Commentary: Additional time required to review this item.

**FY: Park City Municipal Corporation reserves the right to abate any inactive or abandoned construction site. PCMC gives no guarantee of partial CO's. PCMC may require the contractor to complete neighborhood noticing to their satisfaction as needed.**

**\*\* Special Instructions may be given at any time \*\***

Please let us know if you have questions or concerns with the above items. We can and will adjust any of our construction activities to accommodate the City’s needs or wishes. We appreciate the opportunity to submit this report. Any questions can be directed to Rory Murphy at 435-640-5068.

Sincerely,

Rory Murphy  
Hans Fuegi  
Chuck Heath  
CRH Partners, LLC

Attachment 3 – MPD General Construction Mitigation Plan Letter & Exhibits

May 25, 2018

To Whom It May Concern:

Rory Murphy, representing CRH, may deliver and spread excess excavation material on Nastar, LLC property at the Park City Mountain Resort. The soil must be environmentally clean, compacted, covered with topsoil, and reseeded upon completion. This will serve to widen the ski run and fill in depressions.

*Soil to be from Kings Crown Excavation only. -RMB*

Sincerely,



David Bernolfo

(801) 230-4061



NEW SKI TRAIL AND SOIL DISPLACEMENT PLAN

MAY 2018

# KING'S CROWN SUBDIVISION

A PRIVATE SKI-IN/SKI-OUT COMMUNITY PROJECT LOCATED IN PARK CITY, UTAH

**PREPARED FOR:**  
**CRH PARTNERS**  
 1887 GOLD DUST LANE, SUITE 301  
 PARK CITY, UTAH 84060

**PREPARED BY:**  
**Evergreen Engineering, Inc.**

Civil Engineering • Land Surveying • Land Planning  
 9275 Belmont Drive • Suite 100 • Park City, UT 84060  
 927 Belmont Drive • Suite 100 • Park City, UT 84060  
 Phone: (435) 648-8827 • Fax: (435) 648-9219  
 E-mail: info@evergreen-eng.com



**NOTES**

1. SITE ACCESS: TRUCKS SHALL ACCESS THE SITE FROM LOWELL AVE VIA MARSAC MANOR. NO TRUCKS SHALL TRAVEL ALONG UPPER EMPIRE AND/OR UPPER LOWELL AVE.
2. SITE PREPARATION: IN THE PROPOSED AREA OF FILL ON KING'S CROWN SKI RUN, TOPSOIL SHALL BE STRIPPED PRIOR TO FILL PLACEMENT. TOPSOIL TO BE STORED ON SITE AT A LOCATION DETERMINED BY VAIL PROPERTIES AND EARTHWORK CONTRACTOR. UPON COMPLETION OF FILL PLACEMENT, TOPSOIL SHALL BE SPREAD EVEN OVER THE DISTURBED AREA. AFTER TOPSOIL IS SPREAD, THE DISTURBED AREA SHALL BE REVEGETATED WITH APPROVED SKI SLOPE MIX (SHOWN HEREON).
3. DUST CONTROL: WATER TRUCKS SHALL BE USED AS NEEDED TO CONTROL DUST FROM SPREADING IN THE DISTURBED AREA.
4. PLACEMENT OF FILL: FILL SHALL BE SPREAD IN LIFTS NOT TO EXCEED 8" DEPTH. PROPER COMPACTION TECHNIQUES SHALL BE FOLLOWED BETWEEN EACH LIFT.
5. CONTRACTOR SHALL OBTAIN ALL PERMITS AND LICENSES FOR ANY PHASE OF CONSTRUCTION PRIOR TO COMMENCING THAT CONSTRUCTION.
6. ALL MATERIALS AND CONSTRUCTION SHALL CONFORM TO THE DESIGN STANDARDS, DOCUMENTS, CONSTRUCTION SPECIFICATIONS AND STANDARD DRAWINGS, AS REQUIRED BY PARK CITY MUNICIPAL CORPORATION.
7. CONTRACTOR SHALL CONFINED CONSTRUCTION ACTIVITY TO AREAS SHOWN ON THE PLANS AND TO DESIGNATED STORAGE, STAGING, ACCESS, CONSTRUCTION AND MATERIAL WASTE AREAS.
8. COOPERATION WITH UTILITY COMPANIES: THE CONTRACTOR WILL NOTIFY ALL OWNERS OF UTILITIES, INCLUDING, BUT NOT LIMITED TO, WATER, SANITARY SEWER, TELEPHONE, ELECTRICAL, NATURAL GAS AND CABLE T.V. OF THE PROPOSED CONSTRUCTION WITHIN HIS AREA OF OPERATING. THE CONTRACTOR IS ALSO RESPONSIBLE FOR MEETING WITH AND COORDINATING HIS CONSTRUCTION ACTIVITIES WITH THOSE UTILITY COMPANIES INVOLVED WITHIN HIS AREA OF OPERATING FOR THE FIELD LOCATION AND IDENTIFICATION OF THEIR EXISTING UTILITIES.
9. EVERGREEN ENGINEERING, INC. ASSUMES NO RESPONSIBILITY FOR EXISTING UTILITY LOCATIONS. IT IS THE CONTRACTOR'S RESPONSIBILITY TO VERIFY THE LOCATION OF ALL UTILITIES PRIOR TO COMMENCEMENT OF ANY CONSTRUCTION.

**SKI SLOPE MIX**

Durax Hard Fescue	10%
Manchok Bromes Grass	30%
Orchard Grass	30%
Perennial Rye Grass	15%
Pubescent Wheat Grass	15%

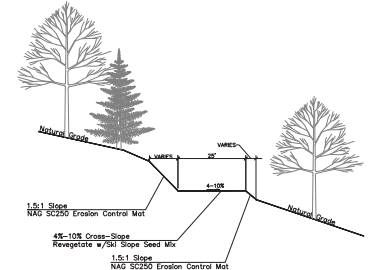
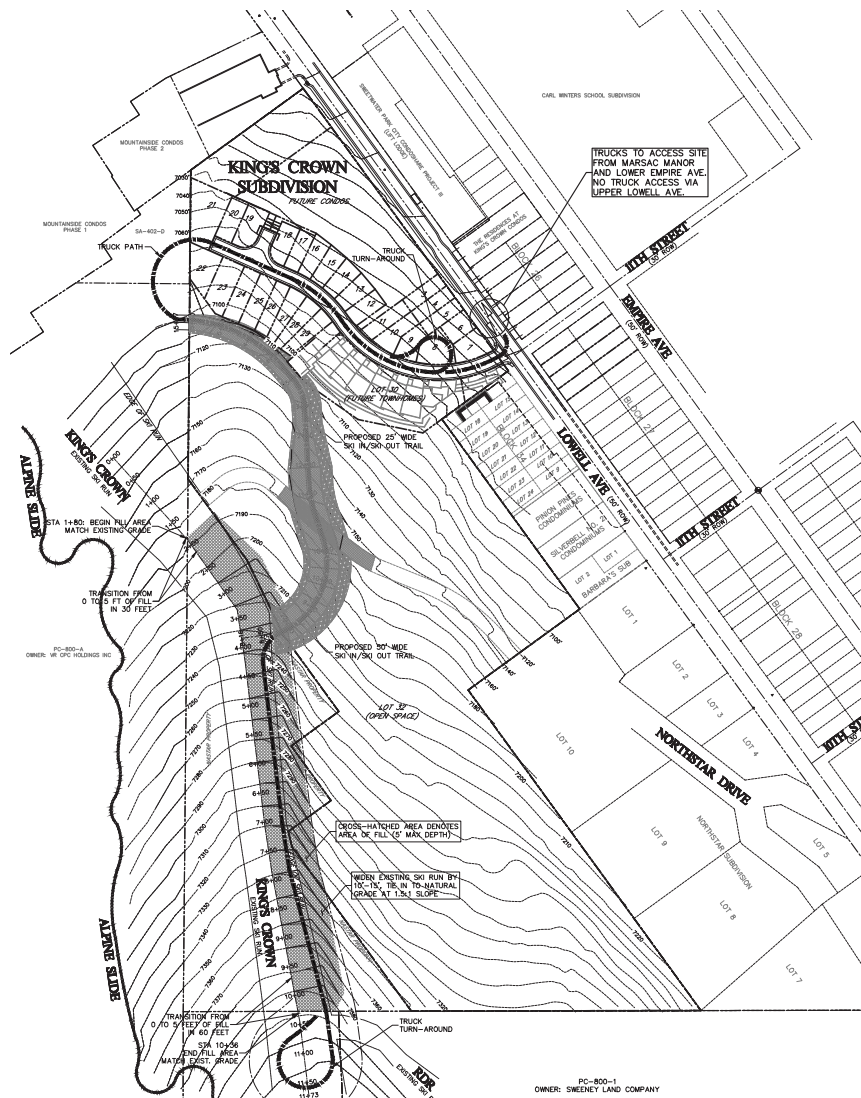
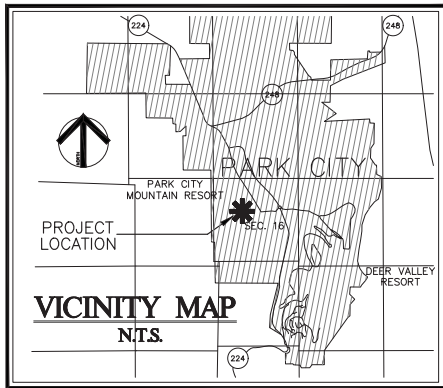

NEW SKI TRAIL TYPICAL CROSS SECTION  
NOT TO SCALE

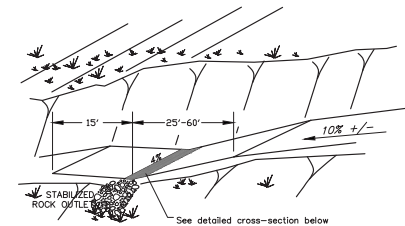

ROLLING DIP  
NOT TO SCALE

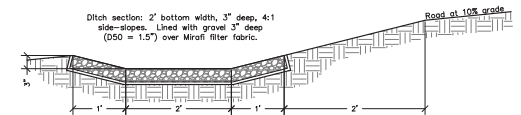

ROLLING DIP  
NOT TO SCALE

**SHEET INDEX**

- C.501 COVER SHEET
- C.502 PROFILE OF EXISTING TRAIL  
STA 5+00.00 THRU 8+16.48
- C.503 PROFILE OF NEW TRAIL  
STA 8+16.48 THRU 13+00.00
- C.504 PROFILE OF KING'S CROWN  
STA 1+85 THRU 10+36
- C.505 CROSS-SECTIONS



PC-800-1  
OWNER: SWEENEY LAND COMPANY

**C.501**  
 Plot date: May 29, 2018  
 Drawing file name: LOWELL-SKI-RUN-RESZEE.dwg  
 © 2018 Evergreen Engineering, Inc.